

TCL

2.1 Channel Sound Bar with Wireless Subwoofer

S522W



User Manual

Contents

1	Before you begin	1
2	Welcome	2
	What's in the box	2
	Overview of the Sound Bar	3
	Overview of the Remote Control	4
	Install/replace the remote control batteries	5
3	Set up your Sound Bar system	7
	Position Your Sound Bar and Subwoofer.....	7
	Mount your Sound Bar on the wall.....	8
4	Connect your Sound Bar system	11
	Connect with the AC power adaptor	11
	Connect with the optical cable.....	13
	Direction for setting up your Sound Bar using an optical cable	14
	Connect with USB disk.....	14
5	Use your Sound Bar system	15
	Operation instruction	15
	Volume and Sound effect regulation	17
6	Specification	18
7	Trademarks	20
8	FCC STATEMENT	21
	Radiation Exposure Statement	21
9	FAQ	22

1 Before you begin

- Carefully read and observe all safety instructions in the safety leaflet.
- This soundbar is intended for indoor use only. In case it accidentally gets in contact with small amounts of water, unplug immediately and use a dry cloth to remove the water.
- Unplug the soundbar if it is not used for long periods of time or during lightning storms.
- Make sure the soundbar is installed on a solid surface or solidly wall-mounted below your TV for the best experience.
- Only use lithium CR2025 battery for the remote control.
- In case any of the cables are visibly damaged or pinched, unplug the soundbar and replace the cable.
- Be careful not to sharply bend the HDMI and optical cable as they may affect the performance.
- Protect your hearing by adjusting to a proper volume.

2 Welcome

Congratulations on the purchase of your new TCL Sound Bar! After it is set up and connected, you can experience a super sound quality and state-of-the-art design to best fit your home entertainment system. You are recommended to read through this user manual which helps you set up, connect and operate the product easily and properly.

Let's get started.

What's in the box

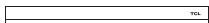

Sound Bar main unit

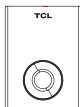

Wireless subwoofer



AC adaptor x 2



Remote control

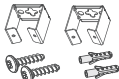

Wall anchor x 2
Wall mount bracket x 2
Wall bracket screw x 2



Warranty Card



Safety Leaflet



Quick Start Guide



Wall Mount Template

Overview of the Sound Bar

Button and jack definition:

Buttons and jacks are defined as follows:

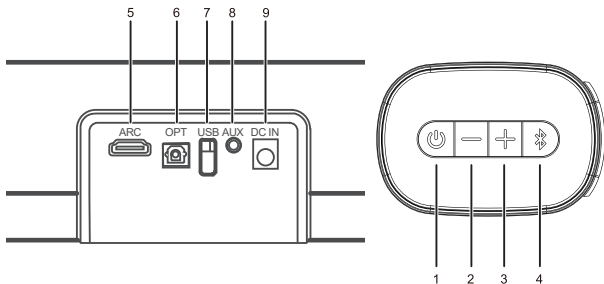

1. : Press to power on, short press to switch function, long press to power off
2. : Press for volume down
3. : Press for volume up
4. : Press for Bluetooth pairing
5. ARC: HDMI ARC
6. OPT: Optical input
7. USB: USB input
8. AUX: 3.5mm connector
9. DC IN: DC14V 2A input

Function indicator light:

1. Red light: in standby mode
2. White light: in operation

Overview of the Remote Control

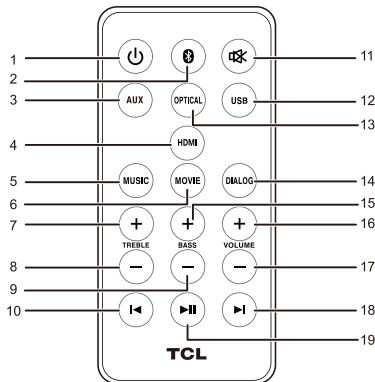

1. : Press to power on and power off.
2. : Press to switch to Bluetooth mode, long press to bluetooth pairing.
3. AUX: Press to switch to AUX mode.
4. HDMI: Press to switch to HDMI mode.
5. MUSIC: Press to select the MUSIC sound mode.
6. MOVIE: Press to select the MOVIE sound mode.
7. TREBLE +: Press to increase treble sound (the white light flashes, when hit the maximum or minimum level white light will be on).
8. TREBLE -: Press to decrease treble sound (the white light flashes, when hit the maximum or minimum level white light will be on).
9. BASS -: Press to decrease bass sound (the white light

flashes, when hit the maximum or minimum level white light will be on).

10. ◀: Press to previous song under Bluetooth, USB or mode.
11. MUTE: Press the mute button and turn on the sound button (white light will flash slowly when mute).
12. USB: Press to switch to USB play when insert USB.
13. OPTICAL: Press to switch to the Optical input mode.
14. DIALOG: Short press to select the DIALOG sound mode.
15. NEWS: Press to select the NEWS sound mode.
16. VOL +: Press or long press to increase volume (the white light flashes, when hit the maximum or minimum level white light will be on).
17. BASS +: Press to increase bass (the white light flashes, when hit the maximum or minimum level white light will be on).
18. VOL -: Press or long press to decrease volume (the white light flashes, when hit the maximum or minimum level white light will be on).
19. ▶: Press to next song under Bluetooth or USB mode.
20. ▶||: Press to play or pause playing under Bluetooth or USB.

Install/replace the remote control batteries

Warnings

Batteries either installed or packed must not be to heat like direct sunlight, fire or similar.

Install the Remote Control:

The Remote Control has a pre-installed lithium CR2025 battery. Remove the protective tab to activate the Remote

Control battery.

Note: The Remote Control works within a range of 6 meters.

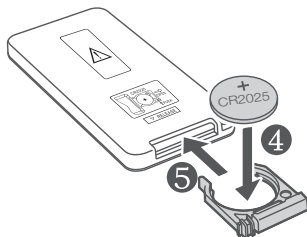
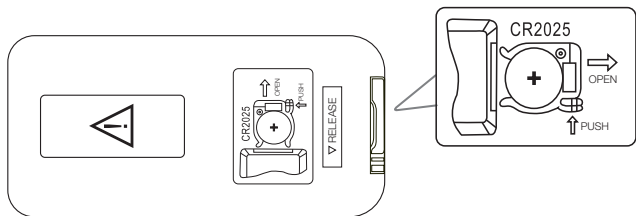
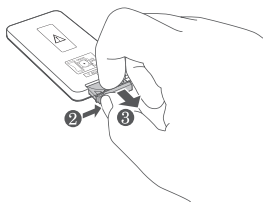
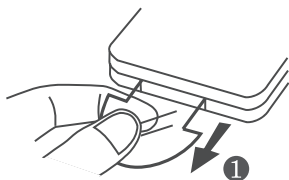

3 Set up your Sound Bar system

Make sure you read all the safety information before you mount the Sound Bar main unit on the wall.

Make sure you use screws provided or specified by the authorized manufacturer.

TCL Overseas Marketing Limited bears no responsibility for accidents or damage caused by improper wall mounting and screws installation or insufficient wall strength, etc. Additional tools (not supplied) are required for installation.

Position Your Sound Bar and Subwoofer

The ideal place to position the Sound Bar main unit is centered underneath your TV.

You are recommended to place the Sound Bar main unit on the top of the cabinet and right below the center of your TV. The distance between the subwoofer and the Sound Bar main unit should be less than 9.8'.

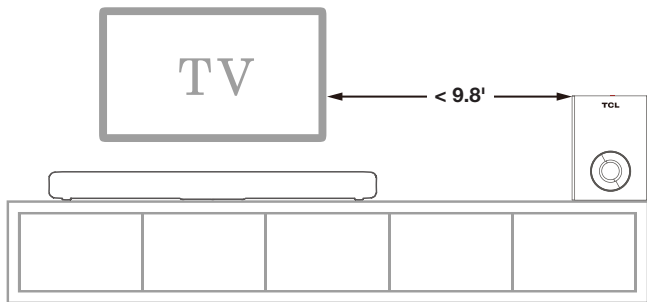

Mount your Sound Bar on the wall

You can choose to mount your Sound Bar main unit on the wall.

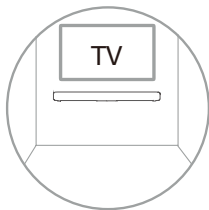

1. Place the supplied wall mount template on the wall. Make sure the wall mount template is at least 3.9" below the center of the TV.
2. Use a level to make sure the Sound Bar is positioned accurately.
3. Use the tape to stick the wall mount template firmly on the wall.

4. Mark on the wall using each marking on the template through the mounting holes.
5. Take away the wall mount template.
6. Drill a screw hole at each marking on the wall.

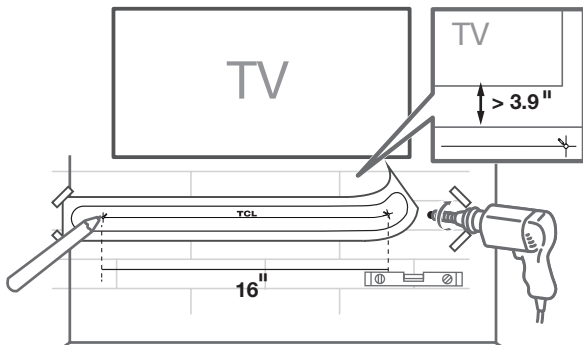

7. Take out the screws from the rear of the soundbar, 2 per side.
8. Use a screwdriver to attach the mounting brackets to the sound bar.
9. Installation complete.

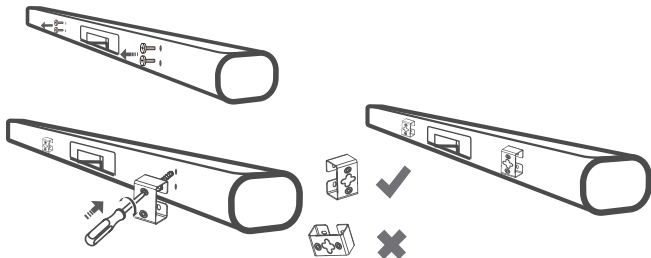

10. Insert the supplied wall anchors into 2 screw holes on the wall.
11. Insert the supplied screws into the wall anchors.
12. Fix and tighten the screws on the wall.
13. Hang the Sound Bar main unit on the screws.

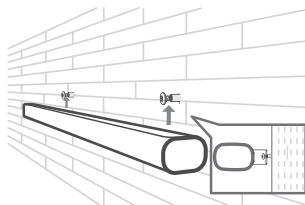
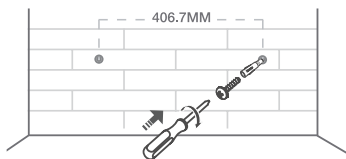

4 Connect your Sound Bar system

After you have fixed the position of the Sound Bar, you can start connecting it to your TV or other devices and listen to the audio through your Sound Bar. Make sure you have muted the audio of your TV or device. For information, check the user manual of your TV or device.

Connect with the AC power adaptor

Connect the supplied AC power adaptors to the sound bar main unit and subwoofer.

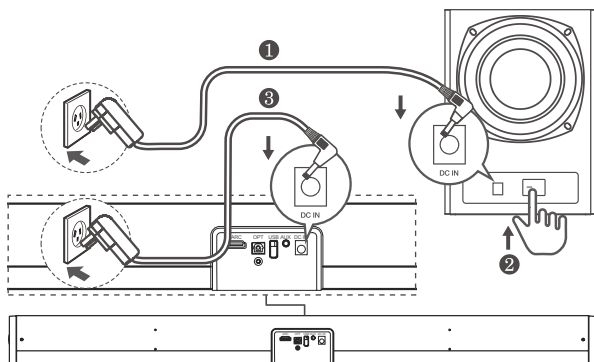

Connect with the HDMI cable

Note:

Make sure your TV or device supports the HDMI ARC feature. For information, check the user manual of your TV or device.

Connect one end of the HDMI cable to the HDMI ARC input connector on your Sound Bar and another end to the HDMI ARC output connector of your TV or device.

To get the best possible audio experience using the HDMI cable, follow below given steps:

For TCL TV:

- Connect HDMI cable from the HDMI (ARC) interface on the sound bar to the HDMI (ARC/eARC) interface on the TV. Connect power cord.
- Enable the CEC function in the settings of the TCL TV.

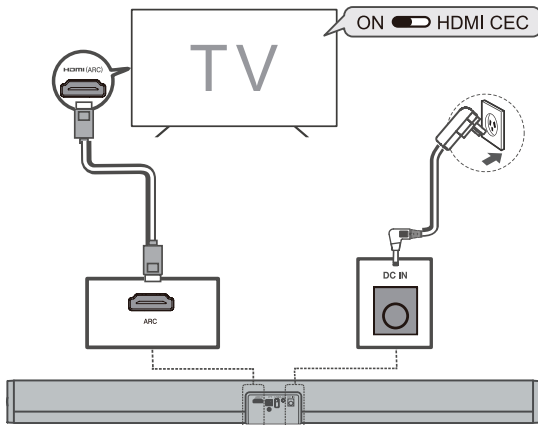

Connect with the optical cable

1. Remove the protective caps from the optical cable when necessary.
2. Connect one end of the optical cable to the optical input connector on your Sound Bar and another end to the optical output connector of your TV or device.

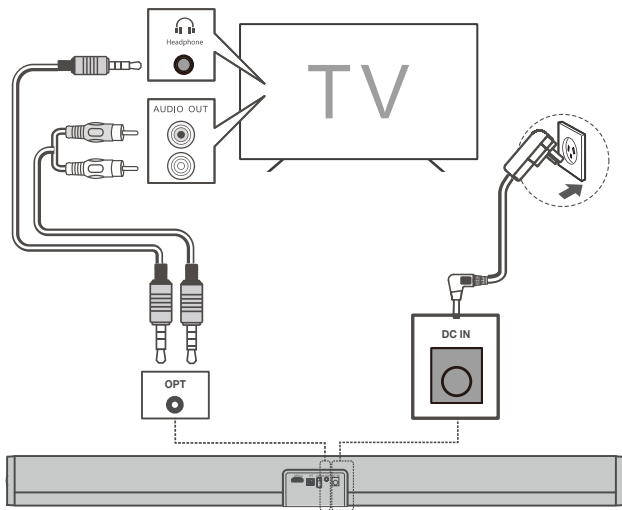

Note

- If there is no sound output from the Sound Bar, try to activate the PCM signal output on your TV or device. PCM is used to convert analog audio signals into digital audio

signals in most devices. For more information of how to activate the PCM signal output, check the user manual of your TV or device.

Direction for setting up your Sound Bar using an optical cable



Do not bend or kink the optical cable (SPDIF) as it is fragile and can easily get damaged and broken.

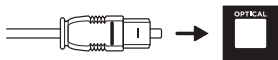

To get the best possible audio experience using the optical cable:

- 1 Press the Home button on your TCL TV Remote.
- 2 Navigate to **Audio option** under **Settings**.
- 3 Uncheck the “**TV speaker enabled**” option.
- 4 Under **S/PDIF** and **ARC**, select **PCM-Stereo**.

Notes

- *Different devices may have different menu options.*
- *Devices such as Blu-ray players, set-top boxes, etc. are also applicable.*

Connect with USB disk

- Press **▶||** on the remote control to listen to/pause/ resume the music.
- Press **◀|** or **|▶** on the remote control to skip to the previous or next track.
- Press **+** or **-** to increase or decrease the volume level.

5 Use your Sound Bar system

Get Started:

1. Make sure you have made all the necessary cable connections before connecting the Soundbar to a wall outlet, the soundbar will enter to standby mode, the indicator will light up in red.
2. Make sure the subwoofer is connected to the power, and turn the button to "ON"
3. Press "**⏻**" on unit or remote control to turn on the soundbar. The Bluetooth indicator will light up.
4. Press "**⏻**" on unit or on remote control to choose various source.

Operation instruction

● Bluetooth Mode

After power on, the machine directly enters Bluetooth mode, along with voice prompt and white light slow flash; long press "**📶**" on Soundbar, Bluetooth enters the pairing status,

with voice prompts and white light fast flash.

1. Put the phone within 9.8' in distance;
2. Activate the Bluetooth function of the phone, so that the phone starts to search for the Bluetooth device (please refer to the phone instructions for details);
3. Select "TCL S522W" from the device that has been searched for, click connection, with voice prompt;
4. If the phone remind you to enter password, enter "0000" and press confirm button to match soundbar to the phone;
5. Press the back button of the phone to exit the phone menu. Make sure the distance between soundbar and phone is within 32.8' and there is no obstacles. At this time, music can be played on the soundbar;
6. Short press "▶||" to play and pause music. Short press "◀◄" or "▶▶" button to previous or next song;
7. To disconnect, short press or long press the "Ⓜ" button on the soundbar, At this time, another mobile phone device can be used to connect Bluetooth playing; If the connection is not selected, the machine will be on waiting for connection status.

● **AUX Mode**

After power on, connect the external audio sources to the AUX jack of soundbar by using the 3.5mm audio cable, and then Press the "⏻" button on the soundbar or the "AUX" button on the remote control to switch to "AUX" mode. At this time, music from the external audio sources such as MP3/CD can be played. (please adjust the volume of the external audio sources accordingly at a comfortable level.)

● **HDMI Mode**

Press the "⏻" button on the soundbar or "HDMI" button on the remote control to switch to "HDMI" mode. At this point, connect the HDMI cable to the TV set and then to the HDMI IN(ARC) jack on the back of the soundbar. Turn on the TV to power on the soundbar. Directly detect the digital signal transmitted by the TV to decode and restore the music play. (Control the TV switch can control the soundbar switch directly).

● **OPTICAL Mode**

Press the "⏻" button on the soundbar or "OPTICAL" button on the remote control to switch to "OPTICAL" mode. At this time, connect the DVD audio and equipment to Soundbar's OPT IN jack with the optical cable. This machine decodes optical fiber digital to restore sound through power amplifier.

● **USB Mode**

After power on, insert the USB into the USB jack of the soundbar; the sound bar automatically goes to USB playback mode and plays the music in USB. Press the "▶||" button to play and pause the music. Press "◀" or "▶" button to select music up and down.

Volume and Sound effect regulation

A. After power on, in any mode of playback, Press or long press the volume "-" button on the soundbar or remote control to lower the volume. Press or long press the volume "+" button on the soundbar or remote control to

raise the volume.

Note: during volume increase and decrease, the indicator light flash; when the volume is increased to the maximum or decreased to the minimum, the indicator light will be on. So remind the user!

- B. After power on, in any mode of playback, Press the remote control to choose sound effect mode: MUSIC, MOVIE and DIALOG.

Note:

1. Under MOVIE mode, there is no function when press "BASS(+, -)", "TREBLE(+, -); Under MUSIC and DIALOG mode, It can adjust sound effect between positive and negative six grades when press "BASS (+, -)", "TREBLE (+, -)" on the remote control.

2. The user can adjust each kind of sound effect mode to enjoy the music according to the personal preference!

6 Specification

Product name	S522W
Output power	20W*2 + 30W
AC/DC adaptor	Input: 100-240V-50/60Hz 1.2A MAX Output: 14V  2A
Speaker frequency	50Hz-20KHz
Bluetooth version	5.1

Bluetooth range	Up to 32.8'
Included in the packaging	Soundbar, Subwoofer, Remote control, AC adaptors, AUX cable (3.5mm to RCA), QSG, Wall-mounted bracket and screws, Wall mount template
Dimensions/Weight	Soundbar: 31.9" x 3.6" x 2.5" /3.3 lb Subwoofer: 6.5" x 9.4 x 11.7" /4.5 lb
Remote Control	Distance/Angel: 19.7'/30° Battery type: Lithium CR2025 battery

7 Trademarks

Bluetooth



The Bluetooth® word mark and logos are registered trademarks owned by Bluetooth SIG, Inc. and any use of such marks by TCL Corporation under license. Other trademarks and trade names are those of their respective owners.

HDMI



HDMI, and HDMI logo and High-Definition Multimedia Interface are trademarks or registered trademarks of HDMI licensing LLC.

8 FCC STATEMENT

1. This device complies with Part 15 of the FCC Rules. Operation is subject to the following two conditions:
 - (1) This device may not cause harmful interference, and
 - (2) This device must accept any interference received, including interference that may cause undesired operation.
2. Changes or modifications not expressly approved by the party responsible for compliance could void the user's authority to operate the equipment.

Note: This equipment has been tested and found to comply with the limits for a Class B digital device, pursuant to Part 15 of the FCC Rules. These limits are designed to provide reasonable protection against harmful interference in a residential installation.

This equipment generates uses and can radiate radio frequency energy and, if not installed and used in accordance with the instructions, may cause harmful interference to radio communications. However, there is no guarantee that interference will not occur in a particular installation. If this equipment does cause harmful interference to radio or television reception, which can be determined by turning the equipment off and on, the user is encouraged to try to correct the interference by one or more of the following measures:

Reorient or relocate the receiving antenna.

Increase the separation between the equipment and receiver.

Connect the equipment into an outlet on a circuit different from that to which the receiver is connected.

Consult the dealer or an experienced radio/TV technician for help.

Radiation Exposure Statement

This equipment complies with FCC radiation exposure limits set forth for an uncontrolled environment. This equipment should be installed and operated with minimum distance 20cm between the radiator & your body.

9 FAQ

Bluetooth paired, connection cannot be completed

Another mobile device may be connected to the soundbar. Disconnect the other connected bluetooth device. Once the device is disconnected, you device should pair automatically-provided it was previously paired.

Volume of Bluetooth playback is low

1. After connections with mobile devices, the volume of Bluetooth device is not up-but at the default output level. Turn up the mobile device volume.
2. Output volume of Bluetooth device is low itself.

Short Bluetooth connection distance

Obstruction exists between mobile devices and Bluetooth device. Remove obstructions.

Bluetooth connection plays normally, sometimes with broken sound.

1. Obstruction exists between mobile devices and Bluetooth device. Remove obstructions.
2. Too far away from Bluetooth device to connected mobile devices, beyond the connection range. Shorten the distance between the Bluetooth device and mobile devices.

Subwoofer not working

Turn on the soundbar and enter Bluetooth mode, double press quickly the pair button, then turn on the subwoofer, the red LED light on subwoofer will be off.

Play no sound

Make sure you activate the PCM signal output on your TV or device when the HDMI ARC/Optical audio source is selected on the sound bar. For more information of how to activate the PCM signal output, check the user manual of your TV or device.

Note: As the above methods are all excluded, the device still can not work, please notify the technician or the customer service!

WARNING:

BATTERIES EITHER INSTALLED OR PACKED MUST NOT BE TO HEAT LIKE DIRECT SUNLIGHT, FIRE OR SIMILAR.

TCL support:

Please visit support.tclusa.com or support.tclcanada.com

Or call 1-877-300-9223

WE ARE READY TO

HELP

**contact us first
with any questions**



**TAKE CARE WHEN
REMOVING THE SOUND BAR**

2022 © TCL Overseas Marketing Limited. All rights reserved. This product has been manufactured by and is sold under the responsibility of TCL Overseas Marketing Limited.

S522W-NA_UM_EN_V0.4

