

S645W-QSG 手册

- S510W NA (Walmart)
- S4510 US
- S645W EU

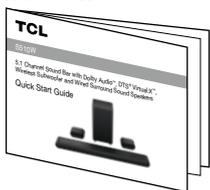

S510W\_NA\_WM\_QSG\_V0.17

文件命名: NA) S510W\_TCL\_QSG-EN\_V1\_230110\_203019473

印刷要求:  
Printing requirements

尺寸: A5  
封面: 80g 双胶 / 单黑  
内页: 80g 双胶 / 单黑  
装订: 20p 骑马订装

专色 / Spot Color:

工艺 / craft:

其它 / other:

环保要求:  
Environmental requirements

- RoHS2.0、Reach
- 包材环保指令 94/62/EC
- 无氯漂白工艺
- 粘合剂为非石油基
- 油墨中禁止使用矿物油 (法国)
- TPCH (美国)
- 大豆油墨印刷
- 纸质符合环保纸 -FSC 认证

无  有 \_\_\_\_\_  
 色板  纸质 \_\_\_\_\_

印刷说明:

1. 要求图文清晰可辨, 内容完整, 折叠正确, 无重影, 墨尿、杂点、脏点、异物、粉点、套印不准。
2. 公差 (mm) : 0<a ≤ 50 (+0.3/-0.2) , 50<a ≤ 150 (+1/-0.5) , >150 (+1.5/-1) 有特殊要求的, 按标示公差执行
3. 尺寸按展开尺寸 / 成品外尺寸

参考  
样板

更新记录 Update Record

版本	命名	变更简述	需求 / 修订人
V1	NA) S510W_TCL_QSG-EN_V1_230110_203019473	-- 正式资料 封底 S510W_NA_WM_QSG_V0.17	客户 / 客户

制 作 人 jy  
PREPARED BY \_\_\_\_\_

D Q E 核 核  
CHECKED BY \_\_\_\_\_

软 件 / 包 装 / 认 证  
工 程 师 核 核  
CHECKED BY \_\_\_\_\_

产 品 / 项 目  
APPROVED BY \_\_\_\_\_

此页附属页  
不 印 刷

# TCL

## S510W

5.1 Channel Sound Bar with Dolby Audio™, DTS® Virtual:X™,  
Wireless Subwoofer and Wired Surround Sound Speakers

### Quick Start Guide



# 1

## Register Your Product

Register your TCL Sound Bar to receive the latest news on product releases, promotional offers, and more!\*

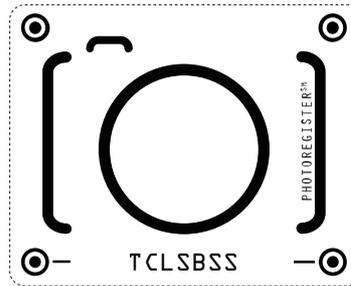

Text to Register

Text a photo of the camera icon to 71403

Or register online at [register.tcl.com](http://register.tcl.com)

Need help? Visit [photoregister.com/help](http://photoregister.com/help) or text HELP to 71403

Enjoy exclusive benefits with registration:



Expedited support and service



Insider tips on your sound bar



Exclusive offers and promotions



Verification of ownership

\*Only Available to U.S. Customers

# 2

## What's in the box

Make sure you read all the safety information before you use this product.

User Manual can be found at [www.tcl.com/us](http://www.tcl.com/us) on the specific product page in the "Download" section.



Warning:

To avoid the danger of suffocation, keep plastic packaging away from pets, babies, and children. Do not use packaging bags in cribs, beds, carriages, or playpens.



Sound bar



Subwoofer



Surround Sound Speakers  
(Cable length: 26 ft. 2.96")



Power cord x 2  
(Cable length: 4 ft. 11")



HDMI cable  
(Cable length: 4 ft. 11")



IR pass-through cable  
(Cable length: 9.8")

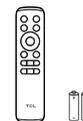

Remote control  
AAA battery x 2

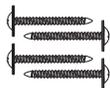

Screw x 4  
(for installing the wall mount brackets)



Wall anchor x 4

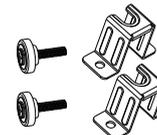

Wall mount screw x 2  
Wall mount bracket x 2

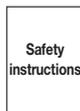

Safety leaflet

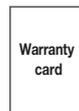

Warranty card



Quick Start Guide

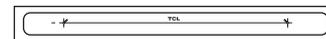

Wall mount template

- ❶ AC input power connector
- ❷ AUX VA input connector
- ❸ AUX input connector
- ❹ IR input connector
- ❺ USB Type A connector
- ❻ Optical input connector
- ❼ HDMI ARC connector

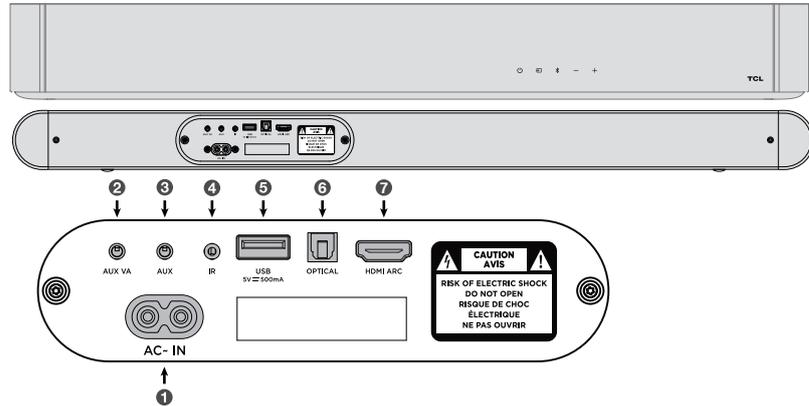

Source button:

Short press: Switch input sources  
(HDMI-ARC/Optical/AUX/AUX VA/USB/Bluetooth)  
Long press: Enter subwoofer pairing  
(If subwoofer disconnected)

Volume buttons:

Press to increase or decrease the volume level.



Power button:

Short Press: Power On/Sleep  
Long Press: Power Off

Bluetooth button:

Short Press: Select Bluetooth mode  
Long press: Bluetooth Pairing

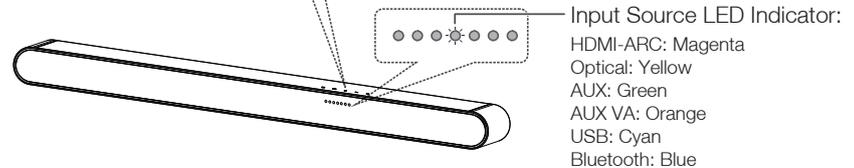

Input Source LED Indicator:

HDMI-ARC: Magenta  
Optical: Yellow  
AUX: Green  
AUX VA: Orange  
USB: Cyan  
Bluetooth: Blue

# 3b

## Overview

### Wireless subwoofer

The subwoofer will pair automatically with sound bar upon first use. In case of a problem, take the following steps to manually pair:

1. Press and hold the **PAIR** button on the subwoofer for 3 seconds until an amber light begins flashing above the pair button.
2. Press and hold the **⏏** button on the sound bar until a yellow LED indicator flashes on the sound bar. After a short while, the sound bar LED will turn green and the subwoofer LED will turn solid.
3. The subwoofer is now connected to the sound bar.

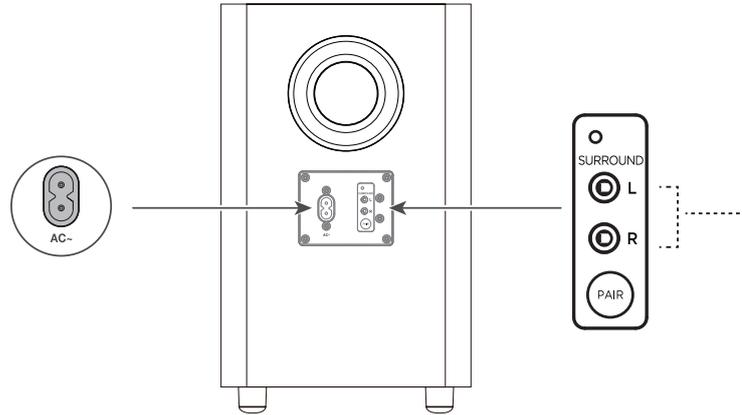

# 3c

## Overview

### Surround Sound Speakers

1. Connect each surround sound speaker into one of the surround ports on the back of the subwoofer.

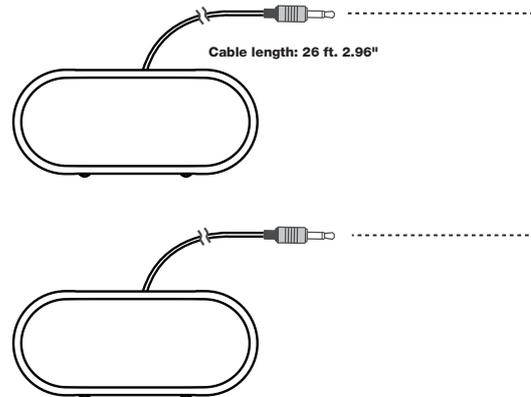

# 4a

## Install or replace the remote batteries

Battery type: 1.5V AAA battery x 2

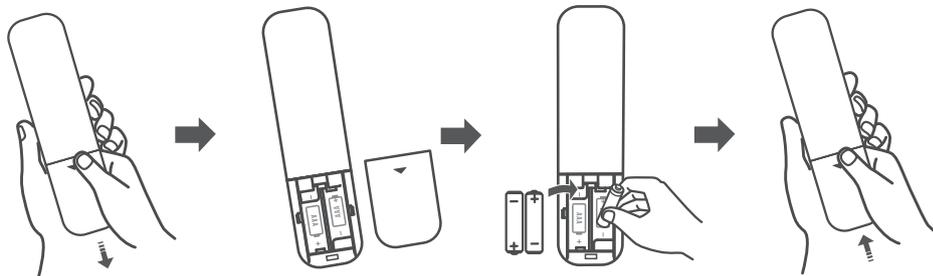

# 4b

## Use the Remote



Warning: Do not expose batteries to excessive heat such as sunshine, fire, or the like. Keep new and used batteries away from children. For disposal or recycling information, please contact your local authorities.



CAUTION: Danger of explosion if the battery is incorrectly replaced. Replace only with the same or equivalent type.

Short press: mute / unmute the sound **1**

Long press: Bluetooth Pairing  
Short press: select Bluetooth mode **2**

Short press: power on / sleep  
Long press: power off **3**

Short press: Switch input sources  
HDMI-ARC/Optical/AUX/AUX VA/USB /Bluetooth **4**

+ Increase volume  
- Decrease volume  
◀ Play previous music; turn to previous item  
▶ Play next music; turn to next item  
⏸ Play/Pause music **5**

Short press to turn on/off DTS Virtual:X **6**

Short Press: switch to Voice Enhance **8**

Short press to enter the Bass Boost Menu **9**

Short press to enter the treble sound effect  
Increase or decrease treble with + / - button **11**

Short press: Switch input sound mode  
Standard, Voice, Music, Movie, Game, Sports **12**

Short press to turn on/off DTS TruVolume **7**

Short press to enter Surround Enhance **10**

Short press to adjust the bass sound effect  
Increase or decrease bass with + / - button **13**

TCL

# 5

## Sound Bar LED Display

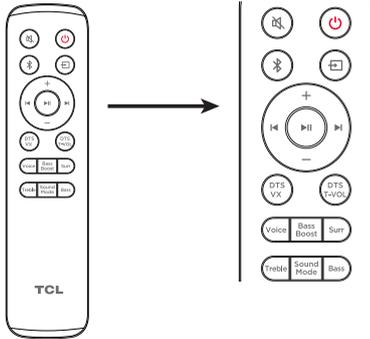

Remote Control	Sound bar Action	LED Behavior on Sound bar
	<b>Power off/Sleep Power On</b>	Power Off: All LEDs light turn on and turn off from the sides to the center. Power On: LEDs will turn on from the center to the sides.
	<b>Mute sound</b>	Mute On: Center LED will flash several times. Mute Off: Current Volume Level will be shown.
	<b>Source</b>	Input Source LED Indicator: HDMI ARC: Magenta Optical: Yellow Aux: Green Aux VA: Orange USB: Cyan Bluetooth: Blue
	<b>Bluetooth Pairing</b>	Blue LED will flash rapidly
	<b>Volume up/down</b>	Volume Up: LEDs will gradually turn on from the center to the sides Volume Down: LEDs will gradually turn off from the sides to the center
	<b>Skip/Previous</b>	Skip: LEDs move from the left to the right Previous: LEDs move from the right to the left
	<b>DTS Virtual:X/TruVolume</b>	Enabled: LEDs will turn on from the center to the sides. Disabled: All LEDs light turn on and turn off from the sides to the center.
	<b>Voice Enhance</b>	Long Press: Enter Voice Enhance adjustment Use UP/DOWN keys to adjust between four different levels. Short Press: Show current Voice Enhance level Use UP/DOWN keys to adjust between four different levels.
	<b>Bass Boost / Night</b>	Long Press: Enable/Disable Night mode with voice broadcast Short Press: Show current Bass Boost level Use UP/DOWN keys to adjust between four different levels.
	<b>Surround Enhance</b>	Short Press: Show current Surround Enhance level Use UP/DOWN keys to adjust between four different levels. Long Press: Turn on or turn off AUX voice assistant.
	<b>Treble Adjustment</b>	Short Press: Show current Treble level. Increase/Decrease using UP/DOWN keys to adjust thirteen different levels.
	<b>Sound Mode</b>	Press to switch sound mode in following order: Standard / Voice / Music / Movie / Game / Sports
	<b>Bass Adjustment</b>	Short Press: Show current Bass level. Increase/Decrease using UP/DOWN keys to adjust thirteen different levels.

# 6a

## Place your Sound Bar and Subwoofer

The ideal place to position the Sound Bar is centered underneath your TV.

 Note: Do not place your sound bar in a location exposed to direct sunlight, heat, fire, or moisture.

 Note: It's recommended to keep the distance within 9.8 feet between the Surround Sound Speakers and the sound bar.

### Top View

### Sound Bar on the table

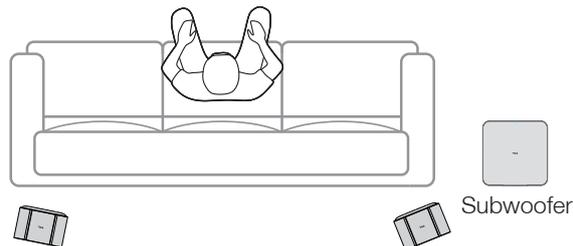

Surround Sound Speaker on the left

Surround Sound Speaker on the right

# 6b

## Wall mount your Sound Bar

Required tools:



- 1 Place the included wall mount template on the wall. Make sure the wall mount template is at least 2 inches below the center of the TV.
- 2 Use a level to make sure the wall mount template is positioned accurately
- 3 Use the tape to stick the wall mount template firmly on the wall.
- 4 Mark on the wall using each marking on the template through the mounting holes.
- 5 Take away the wall mount template.
- 6 Drill screw holes at each marking on the wall.

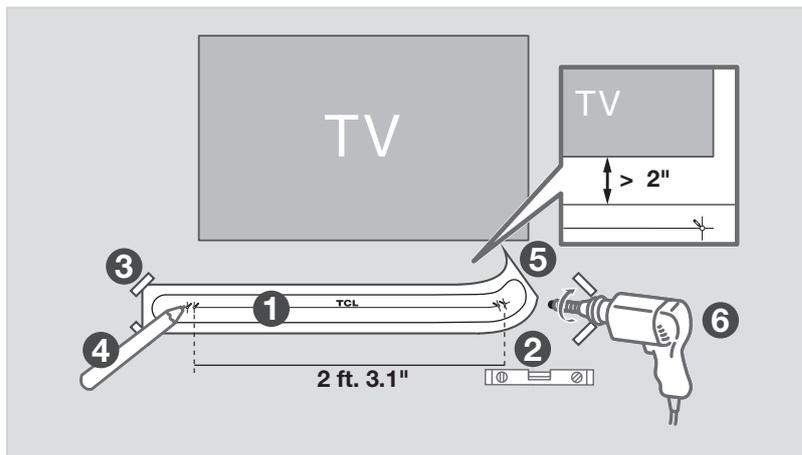

# 6b

## Wall mount your Sound Bar

Required tools:



- 7 Insert the wall anchors in the holes on the wall.
- 8 Insert the included screws with the brackets into the hole of the wall anchors.
- 9 Fix and tighten the wall brackets and screws on the sound bar.
- 10 Replace the screws with the included long wall mount screws.
- 11 Pick up the sound bar and attach it to the brackets, similar to how you would hang a picture. Make sure everything is tight.



Note:  
Do not place your sound bar in a location exposed to direct sunlight, heat, fire, or moisture.  
Only suitable for mounting at heights: < 6 ft. 6.7"

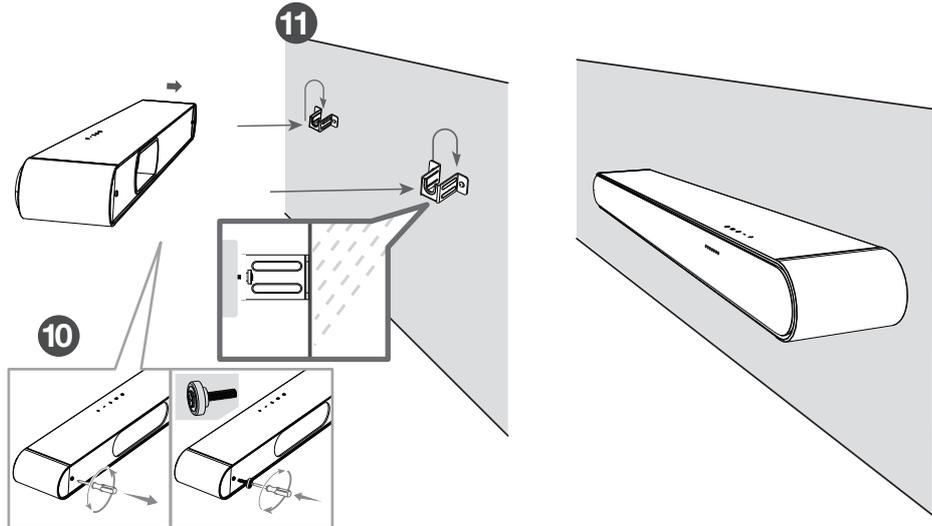
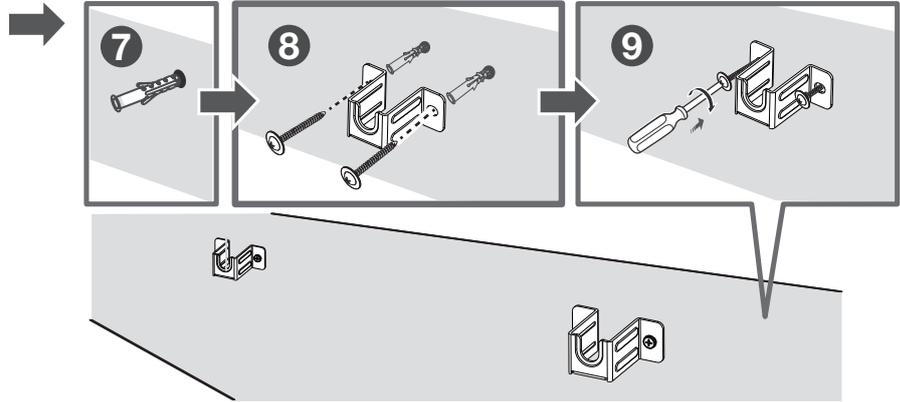

# 6c

## Wall mount Your Surround Sound Speakers

Notes: Only suitable for mounting at heights: < 6 ft. 6.7".  
Wall-mount bracket is not included.

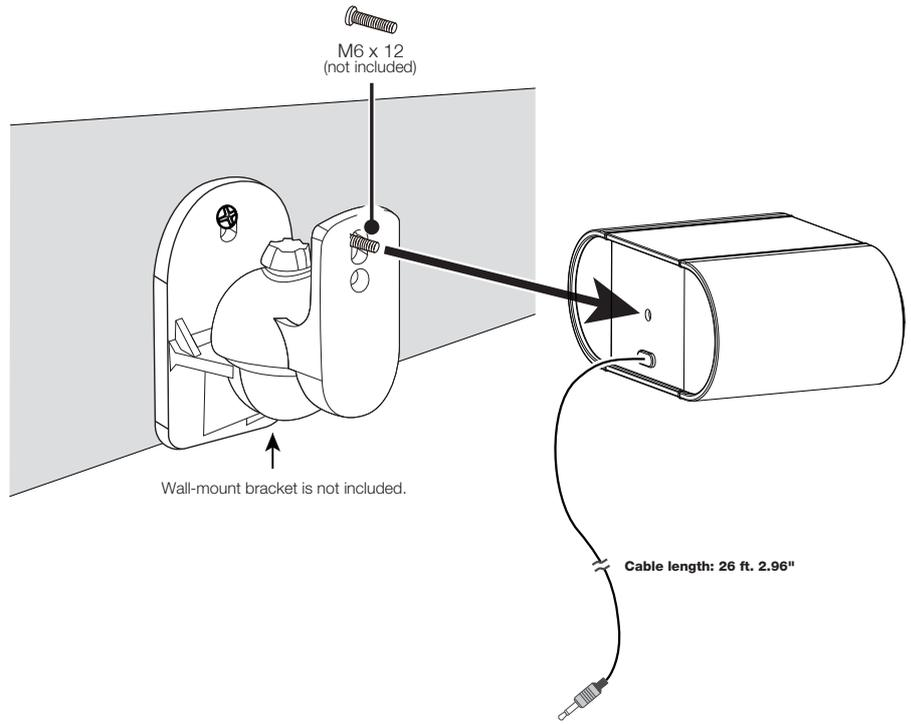

# 7

## Connect to your TV

There are 2 ways to connect your sound bar to the TV (listed in order that we recommend): HDMI ARC (refer to 7a), and Optical (refer to 7b).

If you have a Roku TV™, simply plug in the HDMI cable to the ARC ports and follow the Roku TV Ready™ on-screen instructions.



- ✓ Simple setup
- ✓ One remote
- ✓ Quick settings

# 7a

## HDMI-ARC

Connect the Sound Bar to your TV with the included HDMI cable.

Connect the Sound Bar to the power outlet with the included power cord.

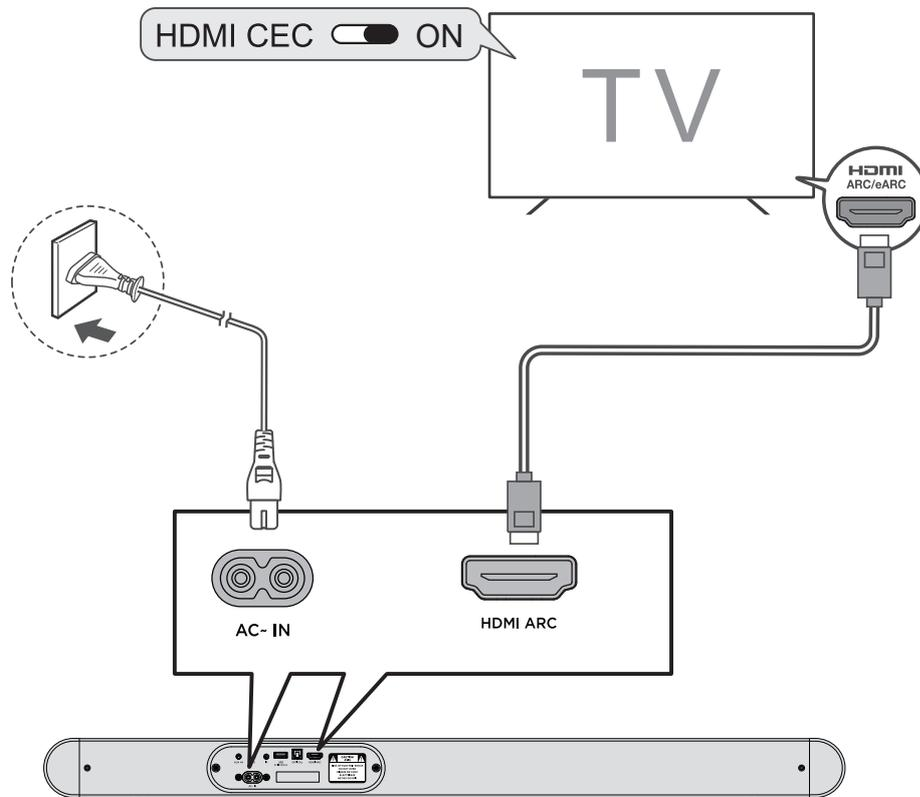

# 7a

## HDMI-ARC

Enable CEC function on TCL TV.

- 1 Connect HDMI cable from the HDMI (ARC) interface on the sound bar to the HDMI (ARC/eARC) interface on the TV.
- 2 Enable the CEC function in the settings of the TCL TV.  
(See TV User Manual for instructions)

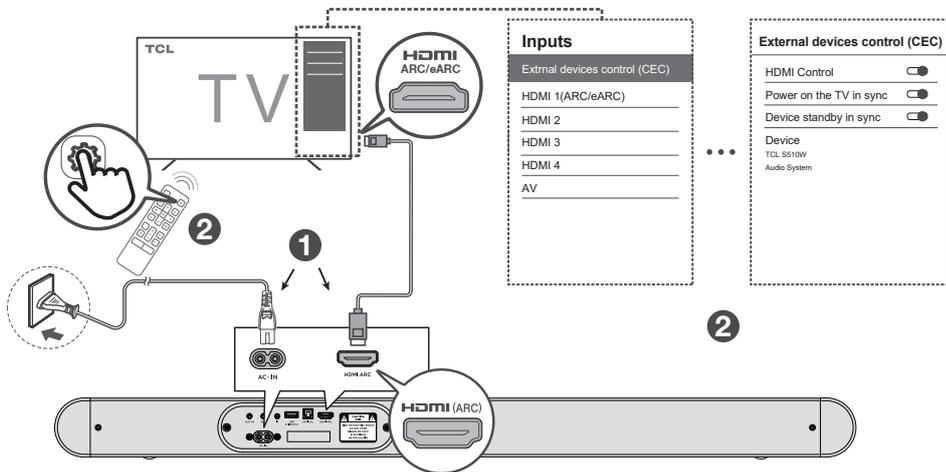

Enable CEC function on other brand TV.

- 1 Connect HDMI cable from the HDMI (ARC) interface on the sound bar to the HDMI (ARC/eARC) interface on the TV.
- 2 Enable the CEC function in the settings of the TV.

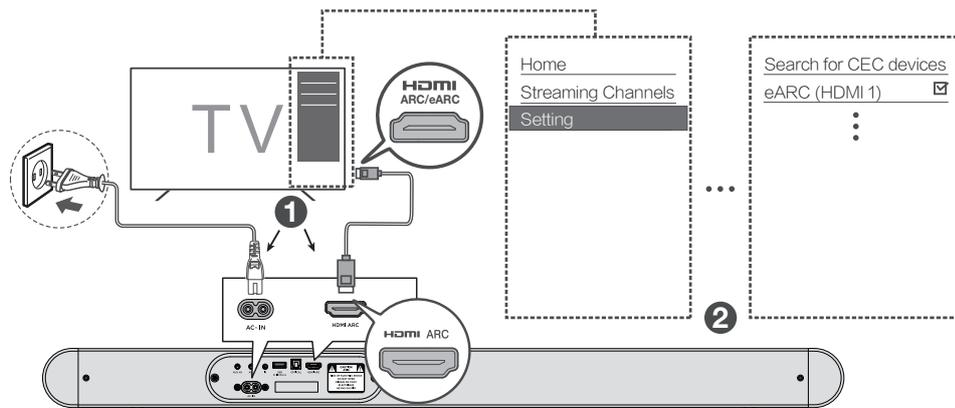

Note:  
CEC (Consumer Electronic Control) function naming may differ by TV manufacturer. This feature may be called CEC, Anynet+, SimpLink, BRAVIA Link, EasyLink or VIERA Link. Please see your TV's user manual for more information.

# 7b

## Optical

Connect the Sound Bar to the TV with an Optical cable.

Connect the Sound Bar to the power outlet with the included power cord.



Warning:  
Do not bend or kink the optical cable (SPDIF) as it is fragile and can easily get damaged and broken.

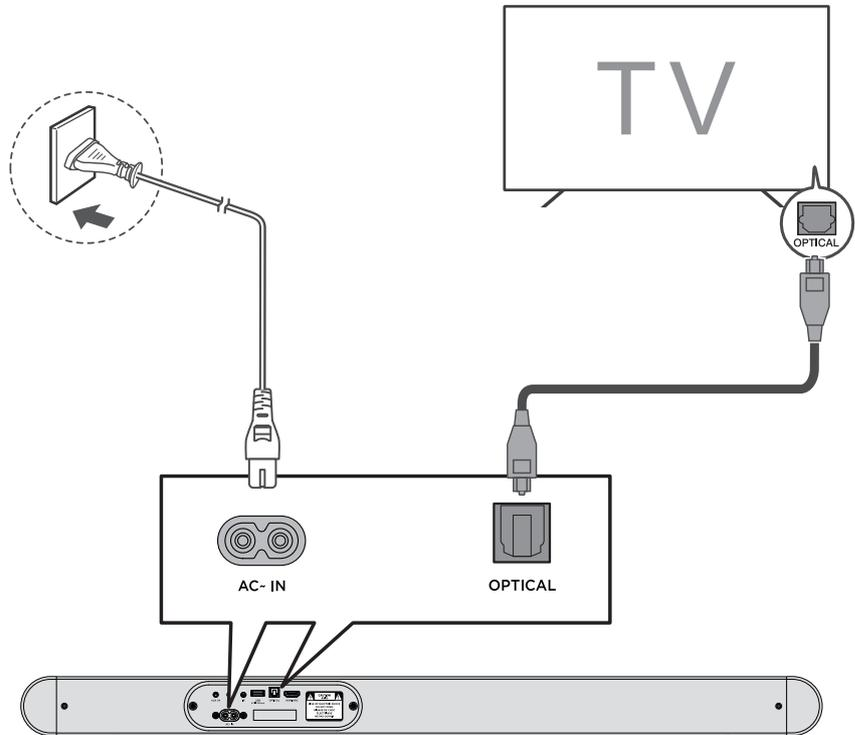

# 8

## Pair with your Bluetooth device

You can stream music from your mobile device via Bluetooth.

1. Press .
2. Press .
3. Press and hold  on the remote control or press and hold  on your sound bar.
  - > You will see blue LEDs flashing rapidly.
  - > The Sound Bar is ready to pair.
4. Power on your Bluetooth device and activate its Bluetooth function.
5. Select **TCL S510W**.
  - > You will see the blue light on for 3 seconds.
  - > Pairing is successful.
6. If you want to pair another device, please repeat step 3.

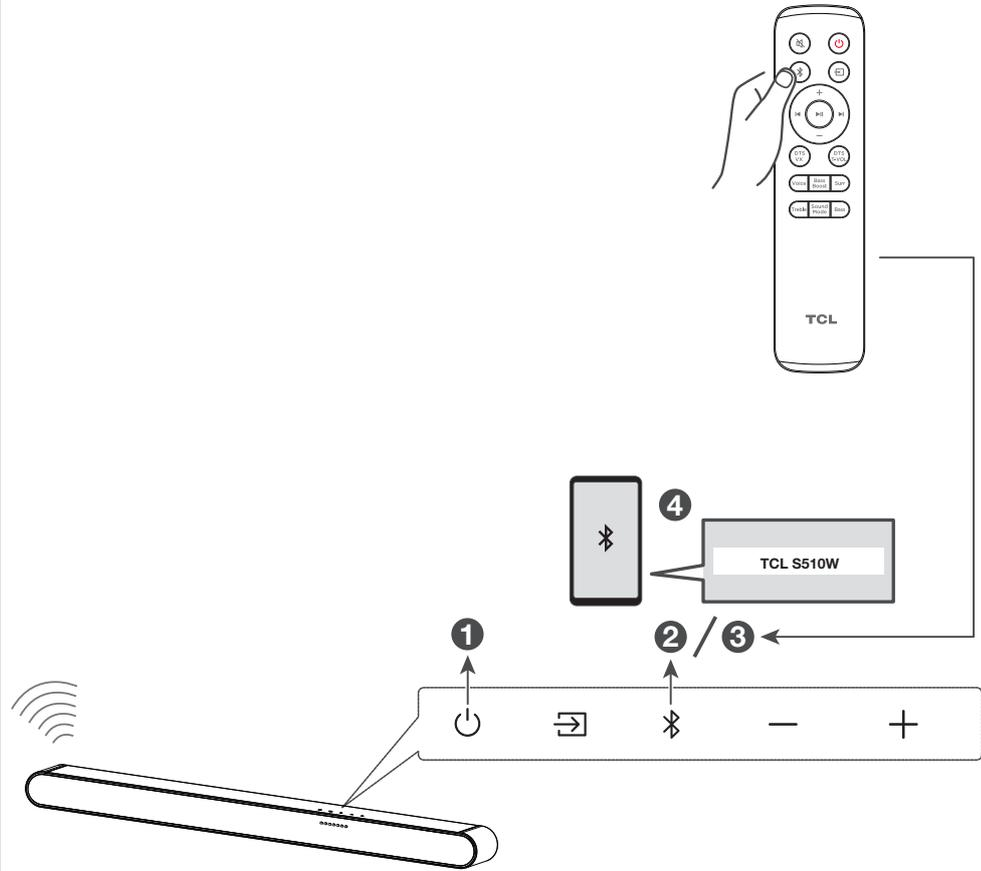

# 9a

## Other connections - USB

Supported audio files: MP3, WMA, FLAC, WAV.

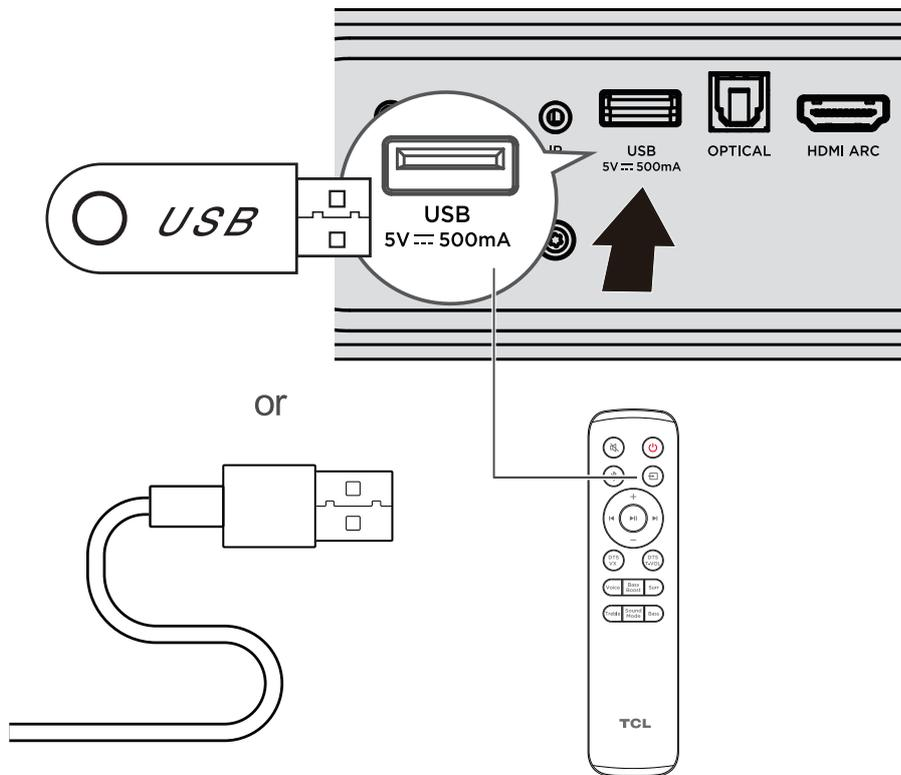

# 9b

## Other connections - AUX

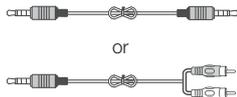

or

Cables are not included.

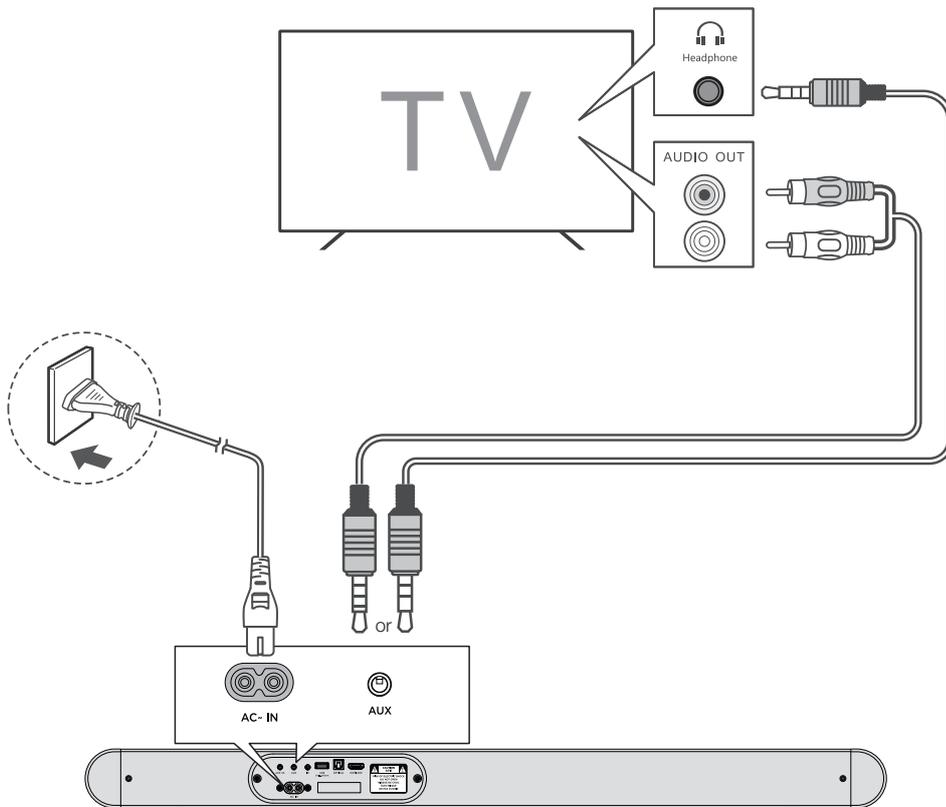

# 9c

## Other connections - AUX VA



Your sound bar can connect to a **Voice Assistant (VA)** device through an AUX VA connection. Once connected, your sound bar will now act as the VA speaker.

### Features and Benefits:

- **Voice Assistant Dedicated Input:** VA is active on the sound bar even if the sound bar is set to a different input with audio playing.
- **Auto Muting:** If playing audio from the sound bar, the VA will play over the original source audio for 10 seconds. If continued after the 10 seconds, the VA audio will mute the original source audio. Once the VA audio is stopped the original source audio will resume.

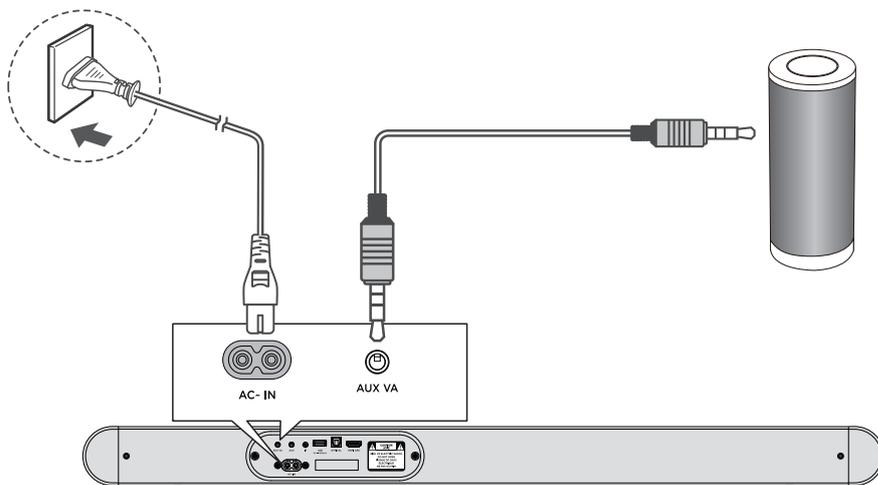

# 10 IR Pass-through



If the sound bar blocks the IR receiver of the TV when placed directly in front of it. You can use the included IR pass-through cable to send IR commands to your TV using the sound bar. First connect one end of the IR pass-through cable to the IR connector on your sound bar. Next, place the other end with the IR blaster close to the TV's IR receiver.

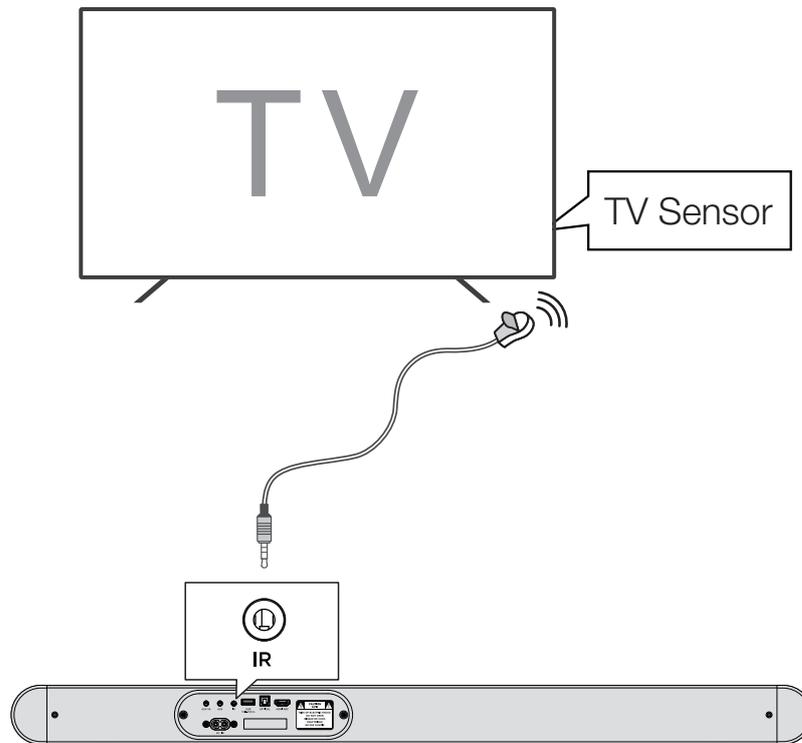

# Trademarks



Roku, the Roku logo, Roku TV, Roku TV Ready, and the Roku TV Ready logo are trademarks and/or registered trademarks of Roku, Inc. This product is Roku TV Ready-supported in the United States. Countries are subject to change. For the most current list of countries in which this product is Roku TV Ready-supported, please email [rokutvready@roku.com](mailto:rokutvready@roku.com).



Manufactured under license from Dolby Laboratories. Dolby, Dolby Audio, and the double-D symbol are trademarks of Dolby Laboratories Licensing Corporation.



The Bluetooth® word mark and logos are registered trademarks owned by Bluetooth SIG, Inc. and any use of such marks by TTE Corporation is under license. Other trademarks and trade names are those of their respective owners.



For DTS patents, see <http://patents.dts.com>. Manufactured under license from DTS, Inc. DTS, Digital Surround, Virtual:X, and the DTS logo are registered trademarks or trademarks of DTS, Inc. in the United States and other countries.

© 2022 DTS, Inc. ALL RIGHTS RESERVED.



"The terms HDMI, HDMI High-Definition Multimedia Interface, HDMI trade dress and the HDMI Logos are trademarks or registered trademarks of HDMI Licensing Administrator, Inc."

**DO NOT RETURN TO STORE**

**WE ARE  
READY TO  
HELP** contact us first  
with any questions

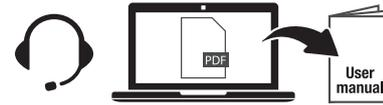

**TCL SUPPORT:**  
[support.tcl.com](https://support.tcl.com)  
1-877-300-9223



**TAKE CARE WHEN  
REMOVING THE SOUND BAR**

TCL / 英文安全单张

区域: USA (Walmart)

■ S510W  
(AAA 电池, 带 5G-WIFI)



文件命名: US) TCL\_Safety-AAA-5G+\_EN\_V1\_230110\_203019543

印刷要求:  
Printing requirements

材质: 80g 双胶纸  
颜色: 单黑 / 单面印刷  
成品: A5 单张

专色 / Spot Color:

工艺 / craft:

其它 /other:

环保要求:  
Environmental requirements

- RoHS2.0、Reach
- 包材环保指令 94/62/EC
- 无氯漂白工艺
- 粘合剂为非石油基
- 油墨中禁止使用矿物油 (法国)
- TPCH (美国)
- 大豆油墨印刷
- 纸质符合环保纸 -FSC 认证

无  有 \_\_\_\_\_  
 色板  纸质 \_\_\_\_\_

参考  
样板

印刷说明:

1. 要求图文清晰可辨, 内容完整, 折叠正确, 无重影, 墨尿、杂点、脏点、异物、粉点、套印不准。
2. 公差 (mm) : 0<a ≤ 50 (+0.3/-0.2) , 50<a ≤ 150 (+1/-0.5) , >150 (+1.5/-1) 有特殊要求的, 按标示公差执行
3. 尺寸按展开尺寸 / 成品外尺寸

更新记录 Update Record

版本	命名 (→日期>物料号)	变更简述
V1	US) TCL_Safety-AAA_EN_V1_230110_203019543	-- 正式资料

<b>TCL</b>	<b>TCL 电子控股有限公司</b> TCL Electronics Holdings Ltd.	版本号: V1.0
<b>PRODUCTION FORM</b>		物料名称: _____
备注: 本物料包含其附件, 请在PC中核实		
品牌 / 区域 (Brand/Region): <u>TCL/US</u>		物料规格: _____
BOM编号 (BOM No.): _____		物料号: _____
日期: _____		物料号: _____
日期: _____		物料号: _____
比例 (Scale) : 1:1		
尺寸 (Size) : 210x148MM		
材料 (Material) : 80g 双胶纸		
颜色 (Color) : 单色黑字 放入附件袋。		
VD.1, 原来扣扣电池版本英文版去掉下面这几句, 用于往那电池US项目		
<small>                 1. 本物料包含其附件, 请在PC中核实                  2. 本物料包含其附件, 请在PC中核实                  3. 本物料包含其附件, 请在PC中核实                  4. 本物料包含其附件, 请在PC中核实                  5. 本物料包含其附件, 请在PC中核实                  6. 本物料包含其附件, 请在PC中核实                  7. 本物料包含其附件, 请在PC中核实                  8. 本物料包含其附件, 请在PC中核实                  9. 本物料包含其附件, 请在PC中核实                  10. 本物料包含其附件, 请在PC中核实                  11. 本物料包含其附件, 请在PC中核实                  12. 本物料包含其附件, 请在PC中核实                  13. 本物料包含其附件, 请在PC中核实                  14. 本物料包含其附件, 请在PC中核实                  15. 本物料包含其附件, 请在PC中核实                  16. 本物料包含其附件, 请在PC中核实                  17. 本物料包含其附件, 请在PC中核实                  18. 本物料包含其附件, 请在PC中核实                  19. 本物料包含其附件, 请在PC中核实                  20. 本物料包含其附件, 请在PC中核实                  21. 本物料包含其附件, 请在PC中核实                  22. 本物料包含其附件, 请在PC中核实                  23. 本物料包含其附件, 请在PC中核实                  24. 本物料包含其附件, 请在PC中核实                  25. 本物料包含其附件, 请在PC中核实                  26. 本物料包含其附件, 请在PC中核实                  27. 本物料包含其附件, 请在PC中核实                  28. 本物料包含其附件, 请在PC中核实                  29. 本物料包含其附件, 请在PC中核实                  30. 本物料包含其附件, 请在PC中核实                  31. 本物料包含其附件, 请在PC中核实                  32. 本物料包含其附件, 请在PC中核实                  33. 本物料包含其附件, 请在PC中核实                  34. 本物料包含其附件, 请在PC中核实                  35. 本物料包含其附件, 请在PC中核实                  36. 本物料包含其附件, 请在PC中核实                  37. 本物料包含其附件, 请在PC中核实                  38. 本物料包含其附件, 请在PC中核实                  39. 本物料包含其附件, 请在PC中核实                  40. 本物料包含其附件, 请在PC中核实                  41. 本物料包含其附件, 请在PC中核实                  42. 本物料包含其附件, 请在PC中核实                  43. 本物料包含其附件, 请在PC中核实                  44. 本物料包含其附件, 请在PC中核实                  45. 本物料包含其附件, 请在PC中核实                  46. 本物料包含其附件, 请在PC中核实                  47. 本物料包含其附件, 请在PC中核实                  48. 本物料包含其附件, 请在PC中核实                  49. 本物料包含其附件, 请在PC中核实                  50. 本物料包含其附件, 请在PC中核实                  51. 本物料包含其附件, 请在PC中核实                  52. 本物料包含其附件, 请在PC中核实                  53. 本物料包含其附件, 请在PC中核实                  54. 本物料包含其附件, 请在PC中核实                  55. 本物料包含其附件, 请在PC中核实                  56. 本物料包含其附件, 请在PC中核实                  57. 本物料包含其附件, 请在PC中核实                  58. 本物料包含其附件, 请在PC中核实                  59. 本物料包含其附件, 请在PC中核实                  60. 本物料包含其附件, 请在PC中核实                  61. 本物料包含其附件, 请在PC中核实                  62. 本物料包含其附件, 请在PC中核实                  63. 本物料包含其附件, 请在PC中核实                  64. 本物料包含其附件, 请在PC中核实                  65. 本物料包含其附件, 请在PC中核实                  66. 本物料包含其附件, 请在PC中核实                  67. 本物料包含其附件, 请在PC中核实                  68. 本物料包含其附件, 请在PC中核实                  69. 本物料包含其附件, 请在PC中核实                  70. 本物料包含其附件, 请在PC中核实                  71. 本物料包含其附件, 请在PC中核实                  72. 本物料包含其附件, 请在PC中核实                  73. 本物料包含其附件, 请在PC中核实                  74. 本物料包含其附件, 请在PC中核实                  75. 本物料包含其附件, 请在PC中核实                  76. 本物料包含其附件, 请在PC中核实                  77. 本物料包含其附件, 请在PC中核实                  78. 本物料包含其附件, 请在PC中核实                  79. 本物料包含其附件, 请在PC中核实                  80. 本物料包含其附件, 请在PC中核实                  81. 本物料包含其附件, 请在PC中核实                  82. 本物料包含其附件, 请在PC中核实                  83. 本物料包含其附件, 请在PC中核实                  84. 本物料包含其附件, 请在PC中核实                  85. 本物料包含其附件, 请在PC中核实                  86. 本物料包含其附件, 请在PC中核实                  87. 本物料包含其附件, 请在PC中核实                  88. 本物料包含其附件, 请在PC中核实                  89. 本物料包含其附件, 请在PC中核实                  90. 本物料包含其附件, 请在PC中核实                  91. 本物料包含其附件, 请在PC中核实                  92. 本物料包含其附件, 请在PC中核实                  93. 本物料包含其附件, 请在PC中核实                  94. 本物料包含其附件, 请在PC中核实                  95. 本物料包含其附件, 请在PC中核实                  96. 本物料包含其附件, 请在PC中核实                  97. 本物料包含其附件, 请在PC中核实                  98. 本物料包含其附件, 请在PC中核实                  99. 本物料包含其附件, 请在PC中核实                  100. 本物料包含其附件, 请在PC中核实  </small>		
制作人 PREPARED BY: _____	手检核 CHECKED BY: _____	电子物料认证 工程审核 CHECKED BY: _____
		复核 / 审核 APPROVED BY: _____

制 作 人  
PREPARED BY yj

D Q E 核 核  
CHECKED BY \_\_\_\_\_

软 件 / 包 装 / 认 证  
工 程 师 审 核  
CHECKED BY \_\_\_\_\_

产 品 / 项 目  
APPROVED BY \_\_\_\_\_

此页附属页  
不 印 刷

## Important safety instructions

Make sure you read all the safety information before you use this product.

TCL North America bears no responsibility for accidents or damages caused by unauthorized changes, modifications or improper use of the product.

User Manual can be found at [www.tcl.com/us](http://www.tcl.com/us) on the specific product page in the "Download" section.

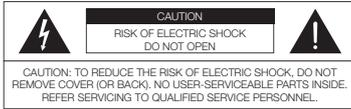

The lightning flash with arrowhead symbol, within an equilateral triangle is intended to alert the user to the presence of uninsulated dangerous voltage within the product's enclosure that may be of sufficient magnitude to constitute a risk of electric shock.



The exclamation point within an equilateral triangle is intended to alert the user to the presence of important operating and maintenance (servicing) instructions in the literature accompanying the product.



This symbol indicates that this product incorporates double insulation between hazardous main voltage and user accessible parts. When servicing, use only identical replacement parts.

### Warnings

- To reduce the risk of fire or electric shock, do not expose this product to rain or moisture. This product should not be exposed to dripping or splashing. No objects filled with liquids, such as vases, should be placed on or near the product.
- The product is unstable if it is not properly placed or mounted to the wall. Be sure to follow the wall mounting instructions provided in the user manual to ensure your safety.
- Do not expose batteries to excessive heat such as sunshine, fire, and so forth.
- To avoid the danger of suffocation, keep plastic packaging away from pets, babies, and children.
- Do not use packaging bags in cribs, beds, carriages, or playpens.

### Safety

- **Read these instructions** - Read all the safety and operating instructions before operating the product.
- **Retain these instructions** - Retain the safety and operating instructions for future reference.
- **Heed all warnings** - Adhere to all warnings on the product and in the operating instructions.
- **Follow all instructions** - Follow all operating and use instructions.
- **Do not use this apparatus near water** - The appliance should not be used near water or moisture - for example, in a wet basement or near a swimming pool and the like.
- **Clean only with a dry cloth.**
- **Do not block any ventilation openings.** Install in accordance with the manufacturer's instructions.
- **Do not install near any heat sources** such as radiators, heat registers, stoves, or other apparatus (including amplifiers) that produce heat.
- **Do not defeat the safety purpose** of the polarized or grounding-type plug. A polarized plug has two blades with one wider than the other. A grounding type plug has two blades and a third grounding prong. The wide blade or the third prong are provided for your safety. If the provided plug does not fit into your outlet, consult an electrician for replacement of the obsolete outlet.
- **Protect the power cord** from being walked on or pinched particularly at plugs, convenience receptacles, and the point where it exits from the product.

- **Use only attachments/accessories** specified by the manufacturer.
- **Use only with the cart, stand, tripod, bracket, or table** specified by the manufacturer, or sold with the apparatus. When a cart is used, use caution when moving the cart/apparatus combination to avoid injury from tip-over.



- **Unplug this apparatus** during lightning storms or when unused for long periods of time.
- **Refer all servicing** to qualified service personnel. Servicing is required when the apparatus has been damaged in any way, such as power-supply cord or plug damaged, liquid has been spilled or objects have fallen into the apparatus, the apparatus has been exposed to rain or moisture, does not operate normally, or has been dropped.

### Cautions

- To prevent electric shock, match wide blade of plug to wide slot, fully insert.
- Do not place any sources of danger on the product (for example: liquid filled objects, lighted candles).
- Disconnect the power cord to shut off when find trouble or not in use. The power cord shall be readily operable.
- Use of controls or adjustments or performance of procedures other than those described herein, may result in hazardous radiation exposure or other unsafe operation.
- The power cord/appliance coupler is used as the disconnect device, the disconnect device must remain readily operable.
- The rating label is located at the bottom or back of the product.
- The use of apparatus in tropical and moderate climates.

### Battery precautions

- Do not mix batteries (old and new or carbon and alkaline).
- Do not dispose of batteries in fire or water.
- Recycle or dispose of batteries as per state and local guidelines.
- Danger of explosion if battery is incorrectly replaced. Replace only with the same or equivalent type.
- When the remote control is not to be used for a long time (more than a month), remove the battery from the remote control to prevent it from leaking.
- If the batteries leak, wipe away the leakage inside the battery compartment and replace the batteries with new ones.
- Keep away the batteries from heat or moisture.
- Do not carry or store batteries with other metallic objects. Doing so could cause batteries to short circuit, leak or explode.
- Never recharge a battery unless it is confirmed to be a rechargeable type.
- If the battery compartment does not close securely, stop using the product and keep it away from children.

## Disposal of your old product and battery

Your product is designed and manufactured with high quality materials and components, which can be recycled and reused.

This product may contain lead and mercury. Disposal of these materials may be regulated due to environmental considerations. For disposal or recycling information, please contact your local authorities.

This product contains batteries:

- Do not incinerate. Batteries may explode if overheated.
- For disposal or recycling information, please contact your local authorities.

**CAUTION:** Risk of explosion if the battery is replaced by an incorrect type.

**CAUTION:** Replacement of a battery with an incorrect type that can defeat a safeguard.

**CAUTION:** Disposal of a battery into fire or a hot oven, or mechanically crushing or cutting of a battery, that can result in an explosion.

**CAUTION:** Leaving a battery in an extremely high temperature surrounding environment that can result in an explosion or the leakage of flammable liquid or gas.

**CAUTION:** A battery subjected to extremely low air pressure that may result in an explosion or the leakage of flammable liquid or gas.

### For 5G WiFi Device

The device for operation in the band 5150-5250 MHz is only for indoor use to reduce the potential for harmful interference to co-channel mobile satellite systems.

## Compliance notice

### Notice for US

#### FCC Information

#### Warning

Changes or modifications to this unit not expressly approved by the party responsible for compliance could void the user's authority to operate the equipment.

#### Notice

This equipment has been tested and found to comply with the limits for a Class B digital device, pursuant to Part 15 of the FCC Rules. These limits are designed to provide reasonable protection against harmful interference in a residential installation. This equipment generates, uses and can radiate radio frequency energy and, if not installed and used in accordance with the instructions, may cause harmful interference to radio communications. However, there is no guarantee that interference will not occur in a particular installation.

If this equipment does cause harmful interference to radio or television reception, which can be determined by turning the equipment off and on, the user is encouraged to try to correct the interference by one or more of the following measures:

- Reorient or relocate the receiving antenna.
- Increase the separation between the equipment and receiver.
- Connect the equipment into an outlet on a circuit different from that to which the receiver is connected.
- Consult the dealer or an experienced radio / TV technician for help.

This device complies with Part 15 of the FCC Rules. Operation is subject to the following two conditions: (1) This device may not cause harmful interference, and

(2) This device must accept any interference received, including interference that may cause undesired operation.

**FCC Radiation Exposure Statement:** This equipment complies with FCC radiation exposure limits set forth for an uncontrolled environment. This equipment should be installed and operated with a minimum distance of 20cm between the radiator and your body. This transmitter must not be co-located or operated in conjunction with any other antenna or transmitter.

## Notice for Canada

#### Class B Clause

This Class B digital apparatus complies with Canadian ICES-003

This device contains licence-exempt transmitter(s)/receiver(s) that comply with Innovation, Science and Economic Development Canada's licence-exempt RSSI(s). Operation is subject to the following two conditions: 1. This device may not cause interference. 2. This device must accept any interference, including interference that may cause undesired operation of the device.

#### IC Radiation Exposure Statement

This equipment complies with ICES RSS-102 radiation exposure limits set forth for an uncontrolled environment. This equipment should be installed and operated with a minimum distance of 20cm between the radiator and any part of your body.

**Warning:** The user is cautioned that changes or modifications not expressly approved by the party responsible for compliance could void the user's authority to operate the equipment.

## Consignes de sécurité importantes

Assurez-vous de lire toutes les informations de sécurité avant d'utiliser ce produit.

TCL Overseas Marketing Limited ne prendra aucune responsabilité pour tous accidents ou endommagements causés par des changements non autorisés, des modifications ou des utilisations inappropriées du produit.



Le symbole de l'éclair en forme de flèche, situé dans un triangle équilatéral, a pour but d'alerter l'utilisateur de la présence d'une tension dangereuse non isolée à l'intérieur du boîtier du produit pouvant être suffisamment importante pour constituer un risque d'électrocution.



Le point d'exclamation dans un triangle équilatéral est destiné à alerter l'utilisateur de la présence de consignes importantes d'utilisation et de maintenance (entretien) dans la documentation accompagnant le produit.



Ce symbole indique que ce produit comporte une double isolation entre la tension principale dangereuse et les pièces accessibles à l'utilisateur. Lors de l'entretien, utilisez uniquement des pièces de rechange identiques.

### Avertissements

- Pour réduire les risques d'incendie ou d'électrocution, n'exposez pas ce produit à la pluie ou à l'humidité. Ce produit ne doit pas être exposé à des gouttes ou des éclaboussures. Aucun objet rempli de liquide, tel qu'un vase, ne doit être placé au-dessus ou à proximité du produit.
- Le produit est installé s'il n'est pas correctement placé ou fixé au mur. Veuillez suivre les instructions de montage mural fournies dans ce manuel d'utilisation pour assurer votre sécurité.
- N'exposez pas les piles à une source de chaleur excessive telle que le soleil, le feu, etc.

### Sécurité

- Lisez ces consignes** – Lisez toutes les consignes de sécurité et d'utilisation avant d'utiliser le produit.
- Conservez ces consignes** – Conservez les consignes de sécurité et d'utilisation pour une consultation ultérieure.
- Respectez tous les avertissements** – Respectez tous les avertissements sur le produit et dans le mode d'emploi.
- Observez toutes les consignes** – Observez le mode d'emploi et toutes les consignes d'utilisation.
- N'utilisez pas cet appareil à proximité d'eau** – Cet appareil ne doit pas être utilisé à proximité d'eau ou d'humidité – par exemple, dans un sous-sol humide ou près d'une piscine, etc.
- Nettoyez uniquement avec un chiffon sec.** Installez conformément aux instructions du fabricant.
- Ne bloquez aucune bouche d'aération.** Installez conformément aux instructions du fabricant.
- Ne l'installez pas près de sources de chaleur** telles que les radiateurs, les bouches de chaleur, les poêles ou autres appareils (y compris les amplificateurs) produisant de la chaleur.
- Ne détruisez pas l'objectif de sécurité** de la fiche polarisée ou mise à la terre. Une fiche polarisée a deux lames avec une plus large que l'autre. Une fiche de type mise à la terre a deux broches et une troisième broche de mise à la terre. La lame large ou la troisième broche sont fournies pour votre sécurité. Si la fiche fournie ne rentre pas dans votre prise, consultez un électricien pour remplacer la prise obsolète.
- Protégez le cordon d'alimentation** des piétinements et des pincements, en particulier au niveau des fiches, des prises de courant et du point de sortie du produit.
- N'utilisez que les pièces jointes / accessoires** spécifiés par le fabricant.
- N'utilisez que avec le chariot**, le pied, le trépied, le support ou la table spécifiés par le fabricant ou vendus avec l'appareil. Lors d'un chariot est utilisé, faites attention lorsque vous déplacez la combinaison chariot/appareil pour éviter les blessures dues au renversement.



- Débranchez cet appareil** lors d'orages ou lors de non-utiliser pendant une longue temps.
- Confiez tout entretien** au personnel qualifié. Un entretien est requis lorsque l'appareil a été endommagé de quelque manière que ce soit, par exemple au niveau du cordon d'alimentation ou de la fiche ou si un liquide a été renversé ou des objets sont tombés dans l'appareil, s'il a été exposé à la pluie ou à l'humidité, ne fonctionne pas normalement ou s'il a été abandonné.

### Mises en garde

- Pour éviter les électrocutions, faites correspondre la lame large de la fiche à la fente large et réalimentez-la complètement.
- Ne placez aucune source de danger sur le produit (par exemple, objets remplis de liquide, bougies allumées).
- Débranchez le cordon d'alimentation pour l'entretenir en cas de problème ou si vous ne l'utilisez pas. Le cordon d'alimentation doit être facilement utilisable.
- L'utilisation de commandes ou de réglages, ou l'exécution de procédures autres que celles décrites dans les présentes, peut entraîner une exposition à des radiations dangereuses ou toute autre opération dangereuse.
- Le couvercle du cordon d'alimentation/de l'appareil est utilisé comme dispositif de déconnexion; le dispositif de déconnexion doit rester facilement utilisable.
- L'étiquette d'identification se trouve au bas ou à l'arrière du produit.

### Précautions relatives à la batterie

- Ne mélangez pas les piles (usées et neuves, au carbone et alcalines).
- Ne jetez pas les piles au feu ou dans l'eau.
- Recyclez ou jetez les piles conformément aux directives nationales et locales.
- Danger d'explosion si la pile est remplacée de manière incorrecte. Remplacez uniquement par le même type ou un type équivalent.
- Lorsque la télécommande ne doit pas être utilisée pendant une longue période (plus d'un mois), retirez la pile de la télécommande pour l'empêcher de couler.
- Si les piles coulent, essayez les écoulements à l'intérieur du compartiment des piles et remplacez les piles par des neuves.
- Gardez les piles à l'écart de la chaleur ou de l'humidité.
- Ne transportez pas et ne stockez pas les piles avec d'autres objets métalliques. Cela pourrait provoquer un court-circuit, un écoulement ou une explosion des piles.
- Ne rechargez jamais une pile sauf s'il est prouvé qu'elle est rechargeable.

### Mise au rebut de votre produit usagé et de la batterie

Votre appareil est conçu et fabriqué avec des composants et des matériaux de haute qualité, pouvant être recyclés et réutilisés.

Ce produit peut contenir du plomb et du mercure. L'élimination de ces matériaux peut être réglementée pour des raisons environnementales. Pour plus d'informations sur la mise au rebut ou le recyclage, contactez les autorités locales.

Ce produit contient des piles non amovibles :

- N' pas incinérer. Les piles peuvent exploser si elles sont surchauffées.
- Pour plus d'informations sur la mise au rebut ou le recyclage, contactez les autorités locales.

**ATTENTION:** Risque d'incendie ou d'explosion si la batterie est remplacée par un type incorrect  
**ATTENTION:** Remplacement d'une batterie par un type incorrect pouvant supprimer une protection

**ATTENTION:** mise au rebut d'une batterie dans un feu ou dans un four chaud, ou écrasement mécanique ou coupure d'une batterie, susceptible de provoquer une explosion

**ATTENTION:** maintien d'une batterie dans un environnement à très haute température pouvant provoquer une explosion ou la fuite de liquide ou de gaz inflammables;

**ATTENTION:** batterie soumise à une pression de l'air extrêmement faible pouvant provoquer une explosion ou la fuite de liquide ou de gaz inflammables.

## Avis de conformité

### Avis pour les États-Unis

Informations sur la FCC

### Avertissement

- Les changements ou les modifications sur cet appareil non expressément approuvés par la partie responsable de la conformité pourraient invalider l'autorité de l'utilisateur pour manipuler l'équipement.
- Pour rester en conformité avec les consignes d'exposition aux RF, placez le produit à au moins 20 cm des personnes proches.

### Remarque

- Cet équipement a été testé et déclaré conforme aux limites imposées aux appareils numériques de classe B, conformément à la section 15 du règlement de la FCC. Ces limites sont conçues pour fournir une protection suffisante contre les interférences préjudiciables dans une installation résidentielle. Cet équipement génère, utilise et peut émettre de l'énergie radioélectrique et, s'il n'est pas installé et utilisé conformément aux instructions fournies, peut produire des interférences affectant les communications radio. Cependant, rien ne garantit que des interférences ne se produiront pas dans certaines installations.

Si cet équipement génère des interférences préjudiciables à la réception de signaux radio ou de télévision (ce qui peut être constaté en éteignant puis en rallumant l'appareil), nous conseillons à l'utilisateur d'essayer une ou plusieurs des mesures suivantes pour tenter de corriger le problème :

- Réorienter ou déplacer l'antenne de réception.
- Éloigner davantage le récepteur de l'équipement.
- Brancher l'équipement sur une prise de circuit différente de celle sur laquelle le récepteur est branché.
- Consulter le revendeur ou un technicien qualifié spécialisé en équipements radio/de télévision.

Pour garantir la conformité continue, tout changement ou modification non expressément approuvé par la partie responsable de la conformité peut annuler l'autorité de l'utilisateur à utiliser cet équipement. (Exemple : utiliser uniquement des câbles d'interface blindés lors de la connexion à un ordinateur ou à des périphériques).

Cet appareil est conforme à la section 15 de la réglementation de la FCC. Le fonctionnement est soumis aux deux conditions suivantes:

- (1) cet appareil ne doit pas causer d'interférences nuisibles, et
- (2) Cet appareil doit accepter toutes les interférences reçues, y compris celles susceptibles de provoquer un fonctionnement indésirable.

**Déclaration de la FCC sur l'exposition aux rayonnements :** Cet appareil est conforme aux limites de la FCC sur l'exposition aux rayonnements définies pour un environnement non contrôlé. Cet équipement doit être installé et utilisé avec une distance minimale de 20 cm entre le radiateur et votre corps. Cet émetteur ne doit pas être placé au même emplacement ni être utilisé avec toute autre antenne ou tout autre émetteur.

**AVERTISSEMENT : Les modifications apportées à cet équipement non expressément approuvées par TCL Corporation peuvent annuler l'autorisation de la FCC d'utiliser cet équipement.**

### Avis pour le Canada

#### Clause de classe B

Cet appareil numérique ne dépasse pas les limites de classe B relatives aux émissions de bruit radioélectrique émises par un appareil numérique, telles que définies dans le Règlement sur les interférences radio du ministère des Communications du Canada.

Cet appareil numérique de classe B est conforme à la norme canadienne ICES-003.

L'émetteur/récepteur exempt de licence contenu dans le présent appareil est conforme aux CNR d'Innovation, Sciences et Développement économique Canada applicables aux appareils radio exempts de licence. L'exploitation est autorisée aux deux conditions suivantes :

- 1) L'appareil ne doit pas produire de brouillage;
  - 2) L'appareil doit accepter tout brouillage radioélectrique subi, même si le brouillage est susceptible d'en compromettre le fonctionnement.
- CAN ICES-3(B)/NMB-3(B)

#### Déclaration IC relative à l'exposition aux rayonnements

Cet appareil est conforme aux limites canadiennes sur l'exposition aux rayonnements définies pour des environnements non contrôlés. Cet émetteur ne doit pas être situé au même endroit ou fonctionner en conjonction avec une autre antenne ou un autre émetteur.

**Attention:** le droit de l'utilisateur de faire usage de l'appareil peut être annulé par des modifications ou changements non approuvés expressément par l'entité en charge de la conformité de l'appareil par rapport aux normes.