



**CFR 47 FCC PART 15 SUBPART C  
ISED RSS-247 ISSUE 2**

**CERTIFICATION TEST REPORT**

*For*

**Headphone**

**MODEL NUMBER: ACTV200BT**

**FCC ID: 2ARUDACTV200BT**

**IC: 24579-ACTV200BT**

**REPORT NUMBER: 4789210087.2-9**

**ISSUE DATE: November 28, 2019**

*Prepared for*

**TCL Entertainment Solutions Limited  
7/F, building 22E, 22 science park east avenue, Hong Kong science park, SHATIN,  
N.T. ,Hong Kong**

*Prepared by*

**UL Verification Services (Guangzhou) Co., Ltd, Song Shan Lake Branch  
Building 10, Innovation Technology Park, No. 1, Li Bin Road,  
Song Shan Lake Hi-Tech Development Zone, Dongguan, People's Republic of China  
Tel: +86 769-22038881  
Fax: +86 769 33244054  
Website: [www.ul.com](http://www.ul.com)**



Revision History

<u>Rev.</u>	<u>Issue Date</u>	<u>Revisions</u>	<u>Revised By</u>
V0	11/28/2019	Initial Issue	



Summary of Test Results			
Clause	Test Items	FCC/IC Rules	Test Results
1	6dB Bandwidth and 99% Occupied Bandwidth	FCC Part 15.247 (a) (2) RSS-247 Clause 5.2 (a) ISED RSS-Gen Clause 6.7	Pass
2	Peak Conducted Output Power	FCC Part 15.247 (b) (3) RSS-247 Clause 5.4 (d)	Pass
3	Power Spectral Density	FCC Part 15.247 (e) RSS-247 Clause 5.2 (b)	Pass
4	Conducted Bandedge and Spurious Emission	FCC Part 15.247 (d) RSS-247 Clause 5.5	Pass
5	Radiated Bandedge and Spurious Emission	FCC Part 15.247 (d) FCC Part 15.209 FCC Part 15.205 RSS-247 Clause 5.5 RSS-GEN Clause 8.9	Pass
6	Conducted Emission Test For AC Power Port	FCC Part 15.207 RSS-GEN Clause 8.8	Pass
7	Antenna Requirement	FCC Part 15.203 RSS-GEN Clause 6.8	Pass
This test report is only published to and used by the applicant, and it is not for evidence purpose in China.			



## TABLE OF CONTENTS

<b>1. ATTESTATION OF TEST RESULTS .....</b>	<b>6</b>
<b>2. TEST METHODOLOGY .....</b>	<b>7</b>
<b>3. FACILITIES AND ACCREDITATION .....</b>	<b>7</b>
<b>4. CALIBRATION AND UNCERTAINTY .....</b>	<b>8</b>
4.1. <i>MEASURING INSTRUMENT CALIBRATION .....</i>	<i>8</i>
4.2. <i>MEASUREMENT UNCERTAINTY.....</i>	<i>8</i>
<b>5. EQUIPMENT UNDER TEST .....</b>	<b>9</b>
5.1. <i>DESCRIPTION OF EUT .....</i>	<i>9</i>
5.2. <i>MAXIMUM OUTPUT POWER.....</i>	<i>9</i>
5.3. <i>CHANNEL LIST .....</i>	<i>10</i>
5.4. <i>TEST CHANNEL CONFIGURATION.....</i>	<i>10</i>
5.5. <i>THE WORSE CASE POWER SETTING PARAMETER.....</i>	<i>10</i>
5.6. <i>DESCRIPTION OF AVAILABLE ANTENNAS .....</i>	<i>11</i>
5.7. <i>WORST-CASE CONFIGURATIONS.....</i>	<i>11</i>
5.8. <i>TEST ENVIRONMENT .....</i>	<i>11</i>
5.9. <i>DESCRIPTION OF TEST SETUP.....</i>	<i>12</i>
5.10. <i>MEASURING INSTRUMENT AND SOFTWARE USED .....</i>	<i>13</i>
<b>6. MEASUREMENT METHODS .....</b>	<b>14</b>
<b>7. ANTENNA PORT TEST RESULTS .....</b>	<b>15</b>
7.1. <i>ON TIME AND DUTY CYCLE.....</i>	<i>15</i>
7.2. <i>6 dB DTS BANDWIDTH AND 99% BANDWIDTH .....</i>	<i>17</i>
7.2.1. <i>GFSK(1Mbps) MODE .....</i>	<i>18</i>
7.2.2. <i>GFSK(2Mbps) MODE .....</i>	<i>22</i>
7.3. <i>PEAK CONDUCTED OUTPUT POWER.....</i>	<i>26</i>
7.3.1. <i>GFSK(1Mbps) MODE .....</i>	<i>27</i>
7.3.2. <i>GFSK(2Mbps) MODE .....</i>	<i>27</i>
7.4. <i>POWER SPECTRAL DENSITY .....</i>	<i>28</i>
7.4.1. <i>GFSK(1Mbps) MODE .....</i>	<i>29</i>
7.4.2. <i>GFSK(2Mbps) MODE .....</i>	<i>31</i>
7.5. <i>CONDUCTED BANDEDGE AND SPURIOUS EMISSIONS.....</i>	<i>33</i>
7.5.1. <i>GFSK(1Mbps) MODE .....</i>	<i>34</i>
7.5.2. <i>GFSK(2Mbps) MODE .....</i>	<i>40</i>
<b>8. RADIATED TEST RESULTS.....</b>	<b>46</b>
8.1. <i>RESTRICTED BANDEDGE.....</i>	<i>51</i>



---

8.1.1.	GFSK(1Mbps) MODE .....	51
8.1.2.	GFSK(2Mbps) MODE .....	55
8.2.	SPURIOUS EMISSIONS (1~3GHz) .....	59
8.2.1.	GFSK(1Mbps) MODE .....	59
8.2.2.	GFSK(2Mbps) MODE .....	65
8.3.	SPURIOUS EMISSIONS (3~18GHz) .....	71
8.3.1.	GFSK(1Mbps) MODE .....	71
8.3.2.	GFSK(2Mbps) MODE .....	77
8.4.	SPURIOUS EMISSIONS 18G ~ 26GHz.....	83
8.4.1.	GFSK(2Mbps) MODE .....	83
8.4.	SPURIOUS EMISSIONS 30M ~ 1 GHz .....	85
8.4.1.	GFSK(2Mbps) MODE .....	85
8.5.	SPURIOUS EMISSIONS BELOW 30M.....	87
8.5.1.	GFSK(2Mbps) MODE .....	87
<b>9.</b>	<b>AC POWER LINE CONDUCTED EMISSIONS .....</b>	<b>90</b>
9.1.1.	GFSK(2Mbps) MODE .....	91
<b>10.</b>	<b>ANTENNA REQUIREMENTS .....</b>	<b>93</b>



# 1. ATTESTATION OF TEST RESULTS

## Applicant Information

Company Name: TCL Entertainment Solutions Limited  
Address: 7/F, building 22E, 22 science park east avenue, Hong Kong science park, SHATIN, N.T. ,Hong Kong

## Manufacturer Information

Company Name: TCL Entertainment Solutions Limited  
Address: 7/F, building 22E, 22 science park east avenue, Hong Kong science park, SHATIN, N.T. ,Hong Kong

## EUT Information

EUT Name: Headphone  
Model: ACTV200BT  
Brand Name: TCL  
Sample Status: Normal  
Sample ID: 2629616  
Sample Received Date: October 18, 2019  
Date of Tested: November 20~28, 2019

APPLICABLE STANDARDS	
STANDARD	TEST RESULTS
CFR 47 FCC PART 15 SUBPART C	PASS
ISED RSS-247 Issue 2	PASS
ISED RSS-GEN Issue 5	PASS

Prepared By:

Checked By:

Kebo Zhang  
Engineer Project Associate

Shawn Wen  
Laboratory Leader

Approved By:

Stephen Guo  
Laboratory Manager



## 2. TEST METHODOLOGY

The tests documented in this report were performed in accordance with KDB 558074 D01 Meas Guidance v05r02, KDB 414788 D01 Radiated Test Site v01r01, CFR 47 FCC Part 2, CFR 47 FCC Part 15, ANSI C63.10-2013, ISED RSS-247 Issue 2 and ISED RSS-GEN Issue 5.

## 3. FACILITIES AND ACCREDITATION

Accreditation Certificate	<p><b>A2LA (Certificate No.: 4102.01)</b> UL Verification Services (Guangzhou) Co., Ltd. Song Shan Lake Branch. has been assessed and proved to be in compliance with A2LA.</p> <p><b>FCC (FCC Designation No.: CN1187)</b> UL Verification Services (Guangzhou) Co., Ltd. Song Shan Lake Branch. Has been recognized to perform compliance testing on equipment subject to the Commission's Declaration of Conformity (DoC) and Certification rules</p> <p><b>ISED(Company No.: 21320)</b> UL Verification Services (Guangzhou) Co., Ltd. Song Shan Lake Branch. has been registered and fully described in a report filed with ISED. The Company Number is 21320.</p> <p><b>VCCI (Registration No.: G-20019, R-20004, C-20012 and T-20011)</b> UL Verification Services (Guangzhou) Co., Ltd. Song Shan Lake Branch. has been assessed and proved to be in compliance with VCCI, the Membership No. is 3793. Facility Name: Chamber D, the VCCI registration No. is G-20019 and R-20004 Shielding Room B , the VCCI registration No. is C-20012 and T-20011</p>
---------------------------	---

Note 1: All tests measurement facilities use to collect the measurement data are located at Building 10, Innovation Technology Park, Song Shan Lake Hi tech Development Zone, Dongguan, 523808, China

Note 2: The test anechoic chamber in UL Verification Services (Guangzhou) Co., Ltd. Song Shan Lake Branch had been calibrated and compared to the open field sites and the test anechoic chamber is shown to be equivalent to or worst case from the open field site.

Note 3: For below 30MHz, lab had performed measurements at test anechoic chamber and comparing to measurements obtained on an open field site. And these measurements below 30MHz had been correlated to measurements performed on an OFS.



## 4. CALIBRATION AND UNCERTAINTY

### 4.1. MEASURING INSTRUMENT CALIBRATION

The measuring equipment utilized to perform the tests documented in this report has been calibrated in accordance with the manufacturer's recommendations, and is traceable to recognize national standards.

### 4.2. MEASUREMENT UNCERTAINTY

Where relevant, the following measurement uncertainty levels have been estimated for tests performed on the apparatus:

Test Item	Uncertainty
Conduction emission	3.62dB
Radiation Emission test(include Fundamental emission) (9kHz-30MHz)	2.2dB
Radiation Emission test(include Fundamental emission) (30MHz-1GHz)	4.00dB
Radiation Emission test (1GHz to 26GHz)( include Fundamental emission)	5.78dB (1GHz-18Gz)
	5.23dB (18GHz-26Gz)
Note: This uncertainty represents an expanded uncertainty expressed at approximately the 95% confidence level using a coverage factor of k=2.	





## 5. EQUIPMENT UNDER TEST

### 5.1. DESCRIPTION OF EUT

EUT Name	Headphone		
Model	ACTV200BT		
Product Description	Operation Frequency	2402 MHz ~ 2480 MHz	
	Modulation Type	Data Rate	
	GFSK	1Mbps	
		2Mbps	
Rated Input	DC 3.7V		

### 5.2. MAXIMUM OUTPUT POWER

Bluetooth Mode	Frequency (MHz)	Channel Number	Max Output Power (dBm)	EIRP (dBm)
GFSK(1Mbps)	2402-2480	0-39[40]	-4.64	-2.23
GFSK(2Mbps)	2402-2480	0-39[40]	-4.66	-2.25



### 5.3. CHANNEL LIST

Channel	Frequency (MHz)	Channel	Frequency (MHz)	Channel	Frequency (MHz)	Channel	Frequency (MHz)
0	2402	11	2424	22	2446	33	2468
1	2404	12	2426	23	2448	34	2470
2	2406	13	2428	24	2450	35	2472
3	2408	14	2430	25	2452	36	2474
4	2410	15	2432	26	2454	37	2476
5	2412	16	2434	27	2456	38	2478
6	2414	17	2436	28	2458	39	2480
7	2416	18	2438	29	2460	/	/
8	2418	19	2440	30	2462	/	/
9	2420	20	2442	31	2464	/	/
10	2422	21	2444	32	2468	/	/

### 5.4. TEST CHANNEL CONFIGURATION

Test Mode	Test Channel	Frequency
GFSK(1Mbps)	Low, Middle, High/ CH0, CH19, CH39	2402MHz, 2440MHz, 2480MHz
GFSK(2Mbps)	Low, Middle, High/ CH0, CH19, CH39	2402MHz, 2440MHz, 2480MHz

### 5.5. THE WORSE CASE POWER SETTING PARAMETER

The Worst Case Power Setting Parameter under 2400 ~ 2483.5MHz Band				
Test Software		Blue Test3		
Modulation Type	Transmit Antenna Number	Test Software Setting value		
		CH 0	CH 19	CH 39
GFSK ( 1Mbps )	1	default	default	default
GFSK ( 2Mbps )	1	default	default	default



### 5.6. DESCRIPTION OF AVAILABLE ANTENNAS

Antenna	Frequency (MHz)	Antenna Type	MAX Antenna Gain (dBi)
1	2402-2480	Ceramic Antenna	2.41

Test Mode	Transmit and Receive Mode	Description
GFSK(1Mbps)	1TX, 1RX	Chain 1 can be used as transmitting/receiving antenna.
GFSK(2Mbps)	1TX, 1RX	Chain 1 can be used as transmitting/receiving antenna.

### 5.7. WORST-CASE CONFIGURATIONS

Bluetooth Mode	Modulation Technology	Modulation Type	Data Rate (Mbps)
BLE	DTS	GFSK(1Mbps)	1Mbit/s
		GFSK(2Mbps)	2Mbit/s

### 5.8. TEST ENVIRONMENT

Environment Parameter	Selected Values During Tests	
Relative Humidity	45 ~ 70%	
Atmospheric Pressure:	1025Pa	
Temperature	TN	22 ~ 28°C
Voltage :	VL	N/A
	VN	DC 3.7V
	VH	N/A

Note: VL= Lower Extreme Test Voltage  
 VN= Nominal Voltage  
 VH= Upper Extreme Test Voltage  
 TN= Normal Temperature

## 5.9. DESCRIPTION OF TEST SETUP

### SUPPORT EQUIPMENT

Item	Equipment	Brand Name	Model Name	Remarks
1	PC	Dell	Vostro 3902	8KNDDDB2
2	AC ADAPTER	Lenovo	ADLX45NLC3A	INPUT:100~240V~1.3A,50/60Hz OUTPUT:20Vdc,2.25A

### I/O CABLES

Cable No	Port	Connector Type	Cable Type	Cable Length(m)	Remarks
1	USB	/	/	1.0	/

### ACCESSORY

Item	Accessory	Brand Name	Model Name	Description
1	/	/	/	/

### TEST SETUP

The EUT can work in an engineer mode with a software through a Laptop.

### SETUP DIAGRAM FOR TEST

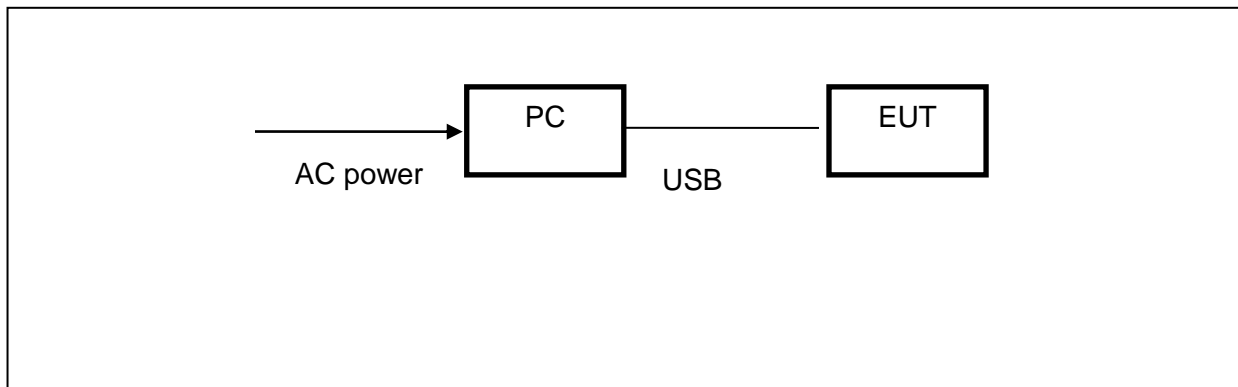



### 5.10. MEASURING INSTRUMENT AND SOFTWARE USED

Conducted Emissions						
Instrument						
Used	Equipment	Manufacturer	Model No.	Serial No.	Last Cal.	Next Cal.
<input checked="" type="checkbox"/>	EMI Test Receiver	R&S	ESR3	101961	Dec.10,2018	Dec.10,2019
<input checked="" type="checkbox"/>	Two-Line V-Network	R&S	ENV216	101983	Dec.10,2018	Dec.10,2019
<input checked="" type="checkbox"/>	Artificial Mains Networks	Schwarzbeck	NSLK 8126	8126465	Dec.10,2018	Dec.10,2019
Software						
Used	Description	Manufacturer	Name	Version		
<input checked="" type="checkbox"/>	Test Software for Conducted disturbance	Farad	EZ-EMC	Ver. UL-3A1		
Radiated Emissions						
Instrument						
Used	Equipment	Manufacturer	Model No.	Serial No.	Last Cal.	Next Cal.
<input checked="" type="checkbox"/>	MXE EMI Receiver	KESIGHT	N9038A	MY56400036	Dec.10,2018	Dec.10,2019
<input checked="" type="checkbox"/>	Hybrid Log Periodic Antenna	TDK	HLP-3003C	130960	Sep.17, 2018	Sep.17, 2021
<input checked="" type="checkbox"/>	Preamplifier	HP	8447D	2944A09099	Dec.10,2018	Dec.10,2019
<input checked="" type="checkbox"/>	EMI Measurement Receiver	R&S	ESR26	101377	Dec.10,2018	Dec.10,2019
<input checked="" type="checkbox"/>	Horn Antenna	TDK	HRN-0118	130939	Sep.17, 2018	Sep.17, 2021
<input checked="" type="checkbox"/>	High Gain Horn Antenna	Schwarzbeck	BBHA-9170	691	Aug.11, 2018	Aug.11, 2021
<input checked="" type="checkbox"/>	Preamplifier	TDK	PA-02-0118	TRS-305-00066	Dec.10,2018	Dec.10,2019
<input checked="" type="checkbox"/>	Preamplifier	TDK	PA-02-2	TRS-307-00003	Dec.10,2018	Dec.10,2019
<input checked="" type="checkbox"/>	Loop antenna	Schwarzbeck	1519B	00008	Jan. 07,2019	Jan. 07,2022
<input checked="" type="checkbox"/>	Band Reject Filter	Wainwright	WRCJV8-2350-2400-2483.5-2533.5-40SS	4	Dec.10,2018	Dec.10,2019
<input checked="" type="checkbox"/>	High Pass Filter	Wi	WHKX10-2700-3000-18000-40SS	23	Dec.10,2018	Dec.10,2019
Software						
Used	Description	Manufacturer	Name	Version		
<input checked="" type="checkbox"/>	Test Software for Radiated disturbance	Farad	EZ-EMC	Ver. UL-3A1		



Other instruments						
Used	Equipment	Manufacturer	Model No.	Serial No.	Last Cal.	Next Cal.
<input checked="" type="checkbox"/>	Spectrum Analyzer	Keysight	N9030A	MY55410512	Dec.10,2018	Dec.10,2019
<input checked="" type="checkbox"/>	Power Meter	Keysight	N1911A	MY55416024	Dec.10,2018	Dec.10,2019
<input checked="" type="checkbox"/>	Power Sensor	Keysight	U2021XA	MY5100022	Dec.10,2018	Dec.10,2019

## 6. MEASUREMENT METHODS

No.	Test Item	KDB Name	Section
1	6 dB Bandwidth	KDB 558074 D01 DTS Meas Guidance v05r02	8.2
2	Peak Output Power	KDB 558074 D01 DTS Meas Guidance v05r02	8.3.1.3
3	Power Spectral Density	KDB 558074 D01 DTS Meas Guidance v05r02	8.4
4	Out-of-band emissions in non-restricted bands	KDB 558074 D01 DTS Meas Guidance v05r02	8.5
5	Out-of-band emissions in restricted bands	KDB 558074 D01 DTS Meas Guidance v05r02	8.6
6	Band-edge	KDB 558074 D01 DTS Meas Guidance v05r02	8.7
7	Conducted Emission Test For AC Power Port	ANSI C63.10-2013	6.2
8	99% Bandwidth	ANSI C63.10-2013	6.9.3



## 7. ANTENNA PORT TEST RESULTS

### 7.1. ON TIME AND DUTY CYCLE

#### LIMITS

None; for reporting purposes only

#### PROCEDURE

KDB 558074 Zero-Span Spectrum Analyzer Method

#### TEST SETUP

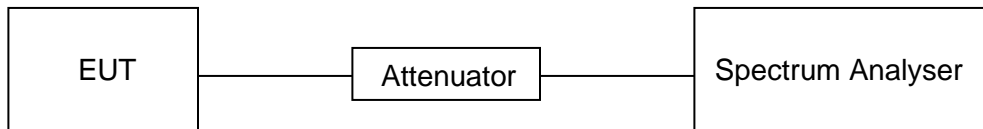

#### TEST ENVIRONMENT

Temperature	25.1°C	Relative Humidity	51%
Atmosphere Pressure	101kPa	Test Voltage	DC 3.7V

#### RESULTS

Mode	On Time (msec)	Period (msec)	Duty Cycle x (Linear)	Duty Cycle (%)	Duty Cycle Correction Factor (db)	1/T Minimum VBW (kHz)	Final setting For VBW (kHz)
GFSK(1Mbps)	0.394	0.626	0.629	62.9%	2.013	2.54	3
GFSK(2Mbps)	0.209	0.625	0.334	33.4%	4.763	4.78	5

Note:

Duty Cycle Correction Factor=10log(1/x).

Where: x is Duty Cycle(Linear)

Where: T is On Time (transmit duration)

If that calculated VBW is not available on the analyzer then the next higher value should be used.



### GFSK(1Mbps) ON TIME AND DUTY CYCLE MID CH



### GFSK(2Mbps) ON TIME AND DUTY CYCLE MID CH

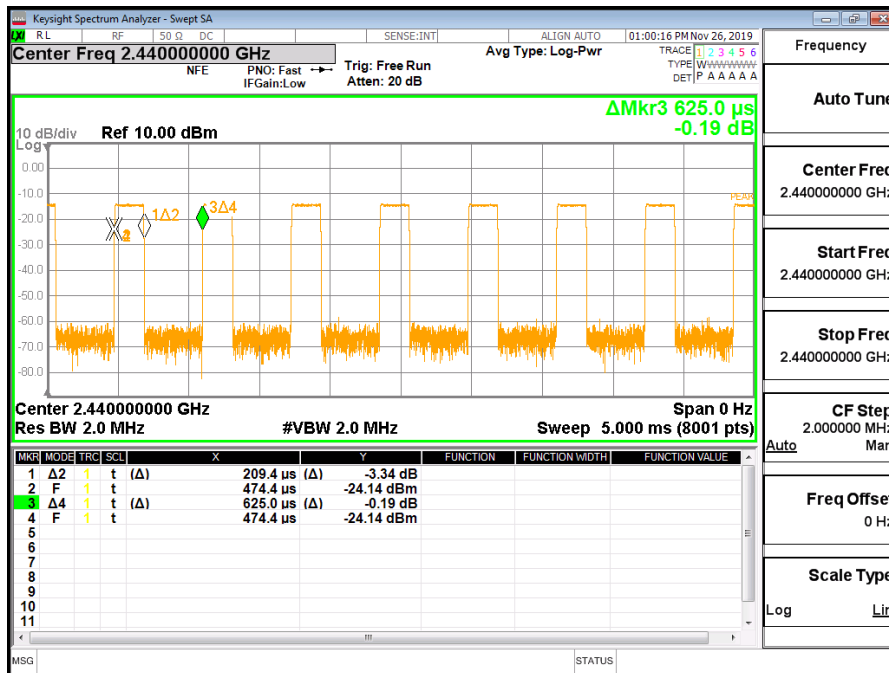



## 7.2. 6 dB DTS BANDWIDTH AND 99% BANDWIDTH

### LIMITS

CFR 47FCC Part15 (15.247) Subpart C ISED RSS-247 ISSUE 2			
Section	Test Item	Limit	Frequency Range (MHz)
CFR 47 FCC 15.247(a)(2) ISED RSS-247 5.2 (a)	6dB Bandwidth	$\geq 500\text{kHz}$	2400-2483.5
ISED RSS-Gen Clause 6.7	99% Occupied Bandwidth	For reporting purposes only.	2400-2483.5

### TEST PROCEDURE

Connect the UUT to the spectrum analyser and use the following settings:

Center Frequency	The center frequency of the channel under test
Detector	Peak
RBW	For 6 dB Bandwidth : 100KHz For 99% Occupied Bandwidth :1% to 5% of the actual occupied bandwidth
VBW	shall be approximately three times RBW
Trace	Max hold
Sweep	Auto couple

Allow the trace to stabilize and measure the maximum width of the emission that is constrained by the frequencies associated with the two outermost amplitude points (upper and lower frequencies) that are attenuated by 6 dB/99% relative to the maximum level measured in the fundamental emission.

### TEST SETUP

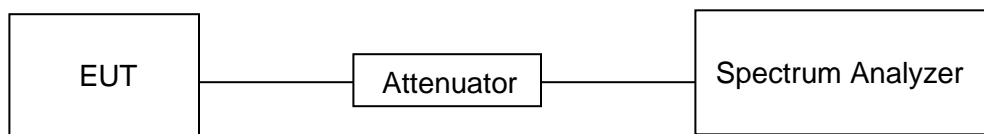



**TEST ENVIRONMENT**

Temperature	25.1°C	Relative Humidity	51%
Atmosphere Pressure	101kPa	Test Voltage	DC 3.7V

**RESULTS**

**7.2.1. GFSK(1Mbps) MODE**

Channel	6dB bandwidth (MHz)	99% bandwidth (MHz)	6dB BW Limit (kHz)	Result
Low	0.7168	1.0332	500	Pass
Middle	0.7086	1.0306	500	Pass
High	0.7120	1.0294	500	Pass

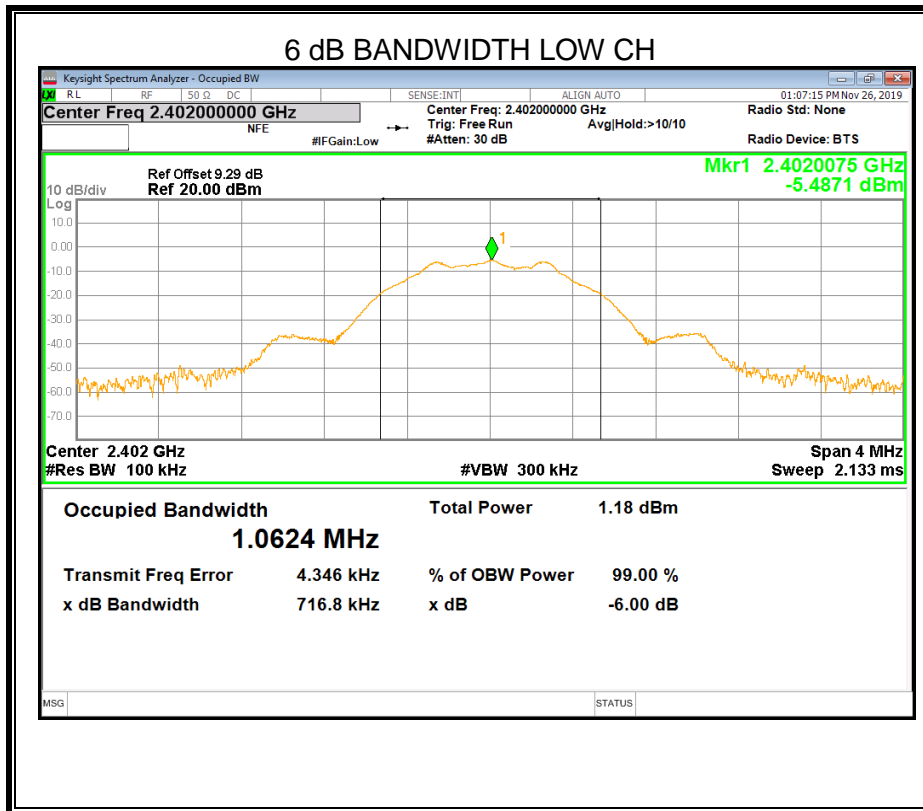

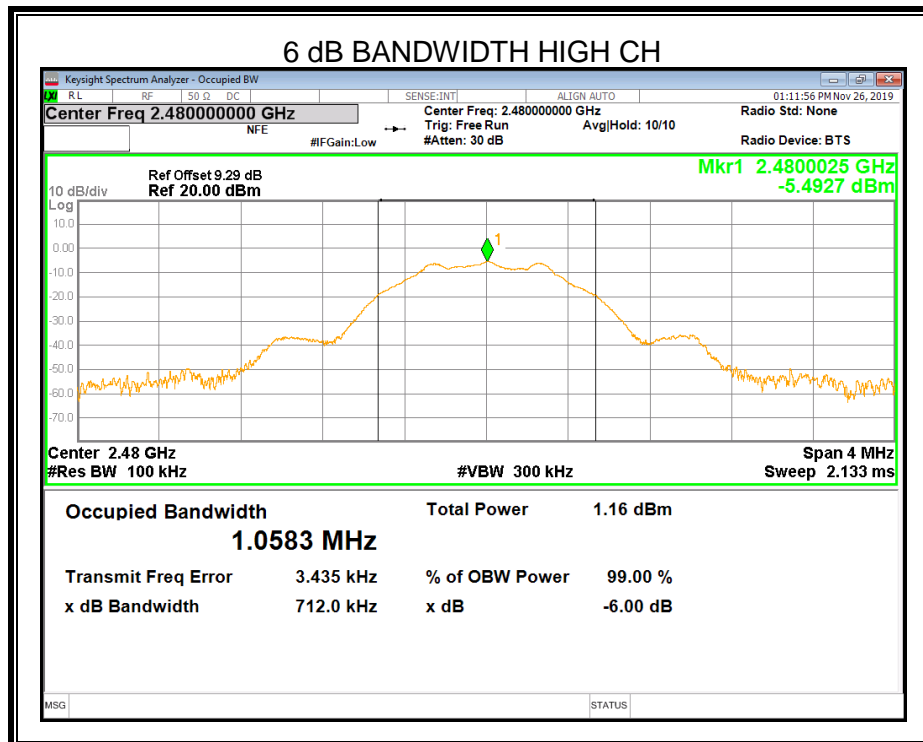
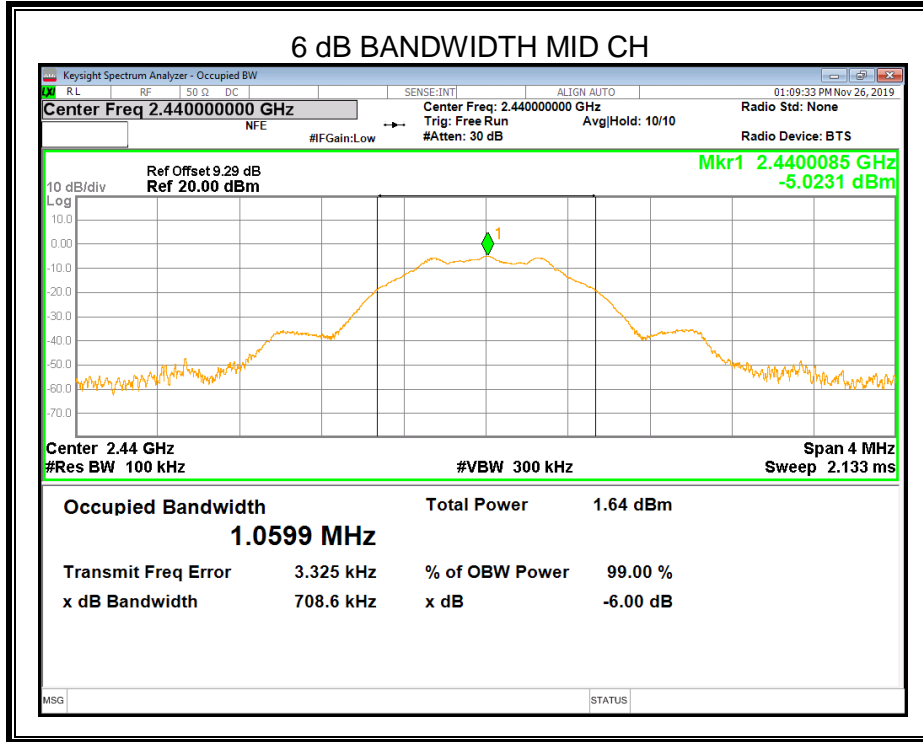

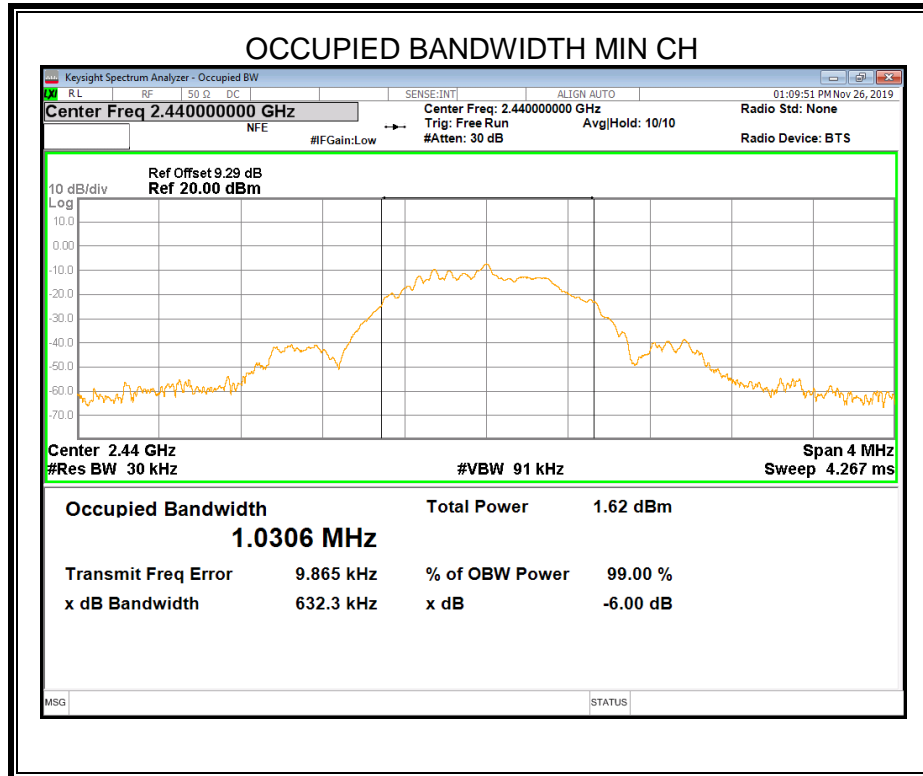
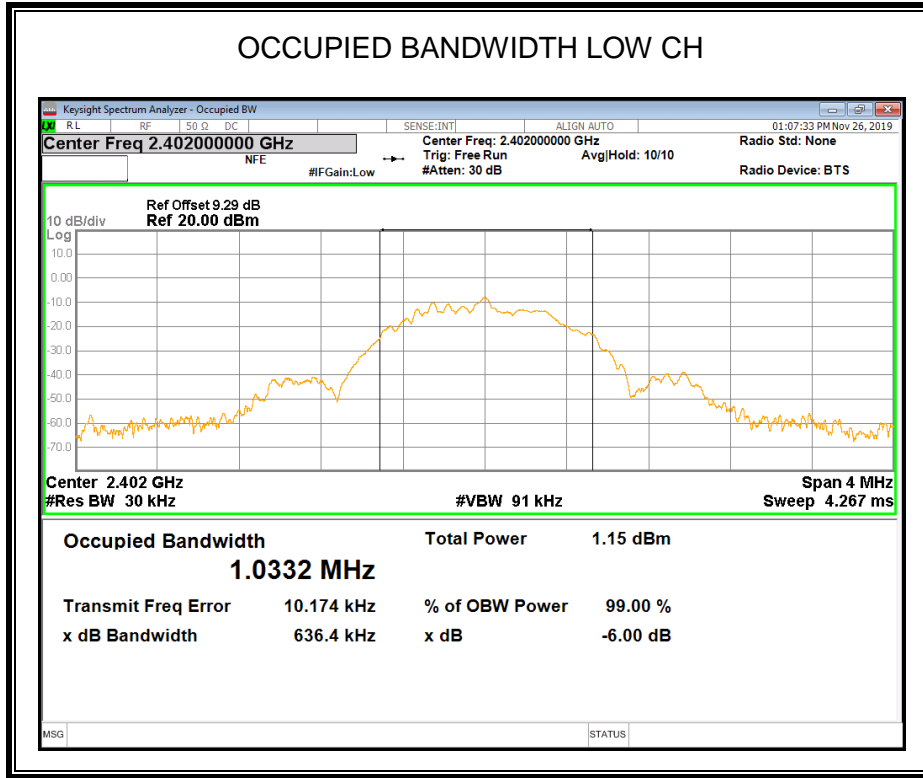

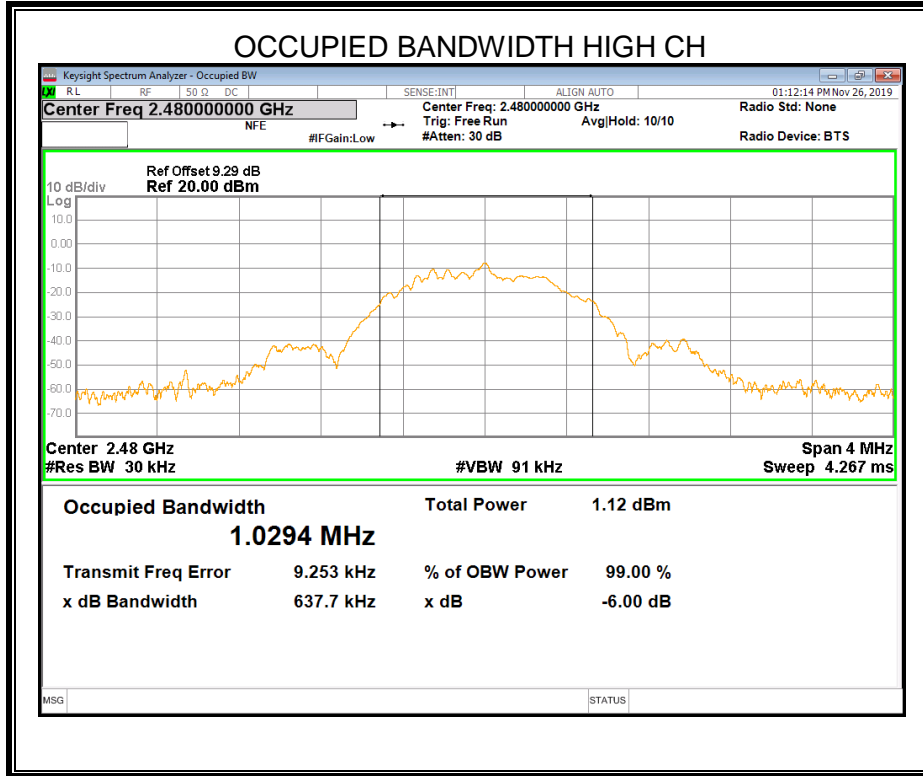

### 7.2.2. GFSK(2Mbps) MODE

Channel	6dB bandwidth (MHz)	99% bandwidth (MHz)	6dB BW Limit (kHz)	Result
Low	1.249	2.0400	500	Pass
Middle	1.245	2.0374	500	Pass
High	1.250	2.0369	500	Pass

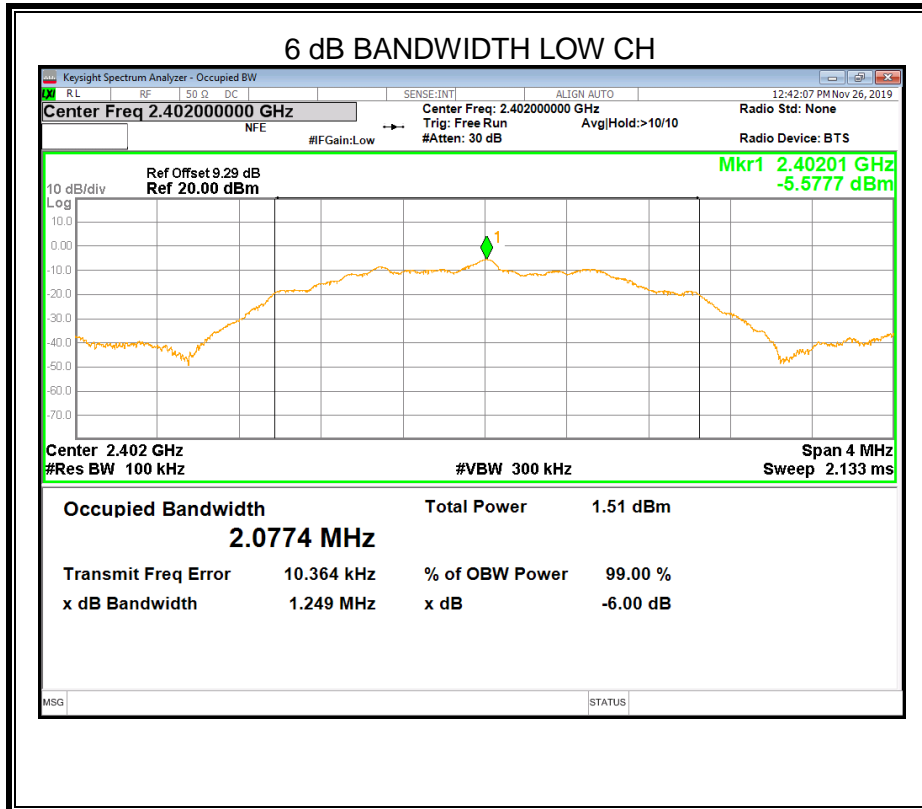

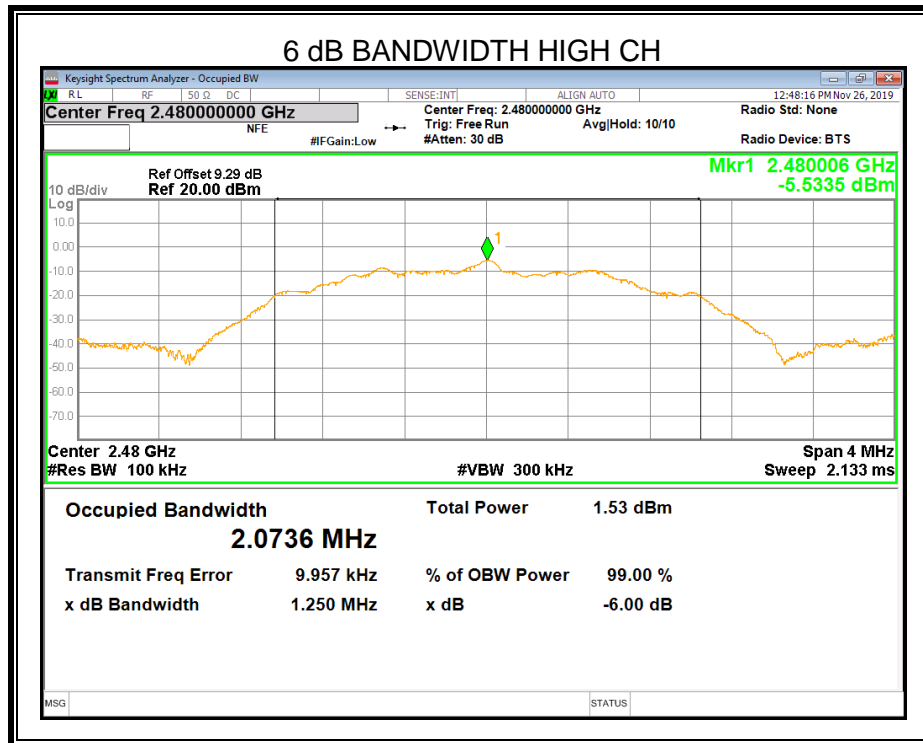
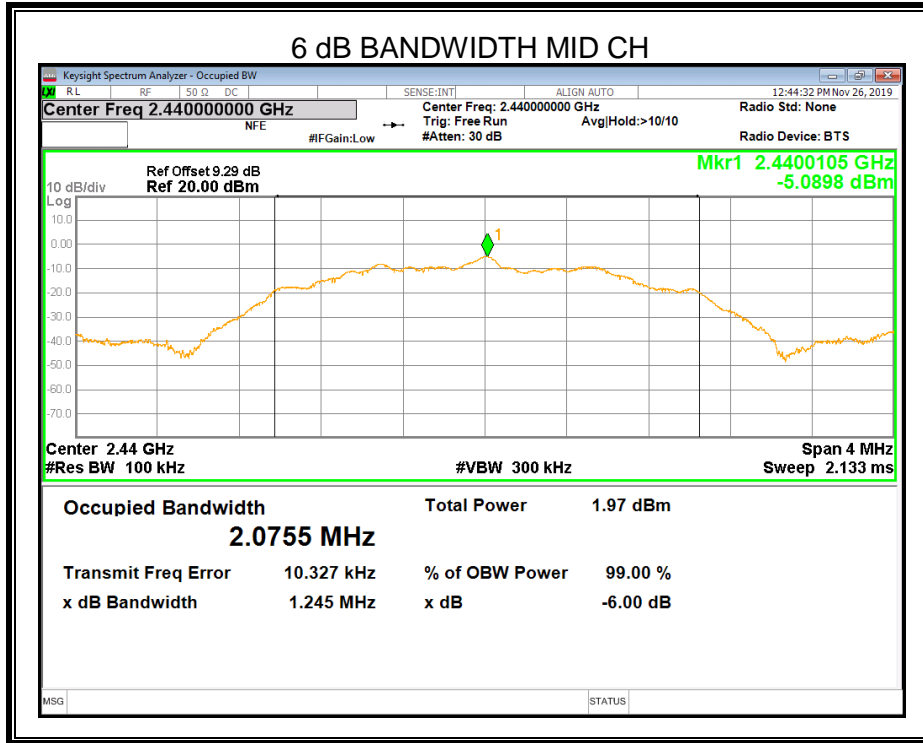

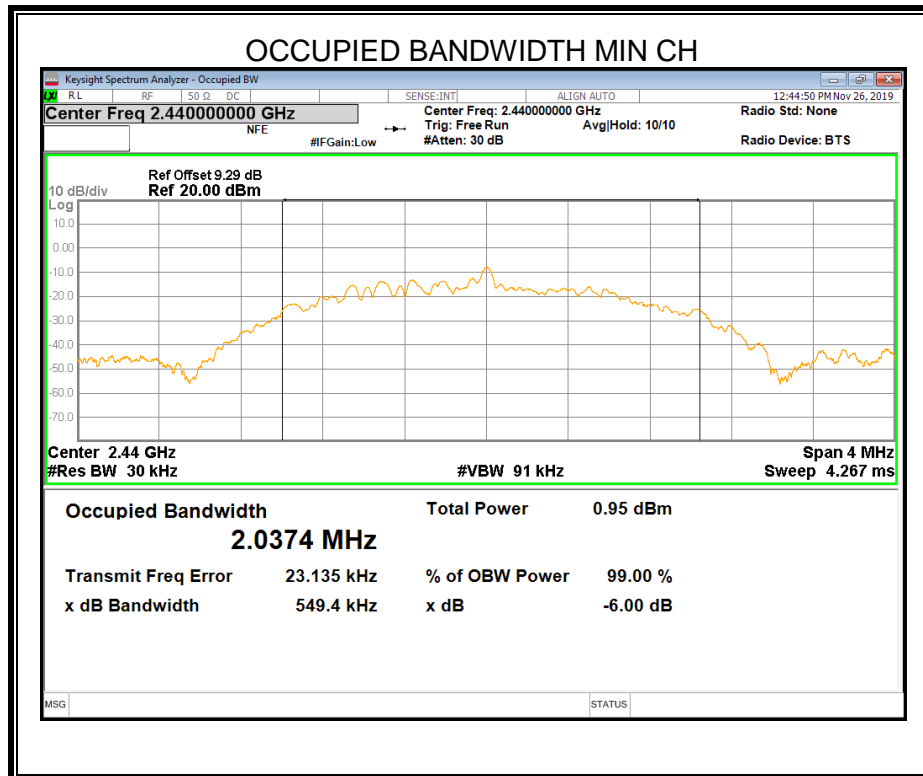
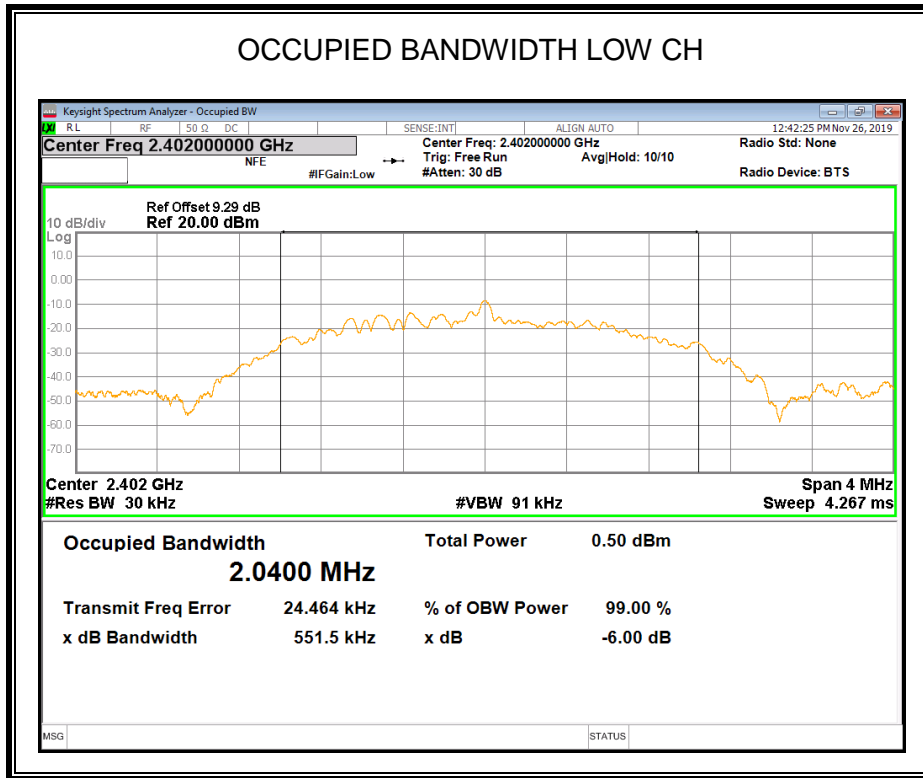



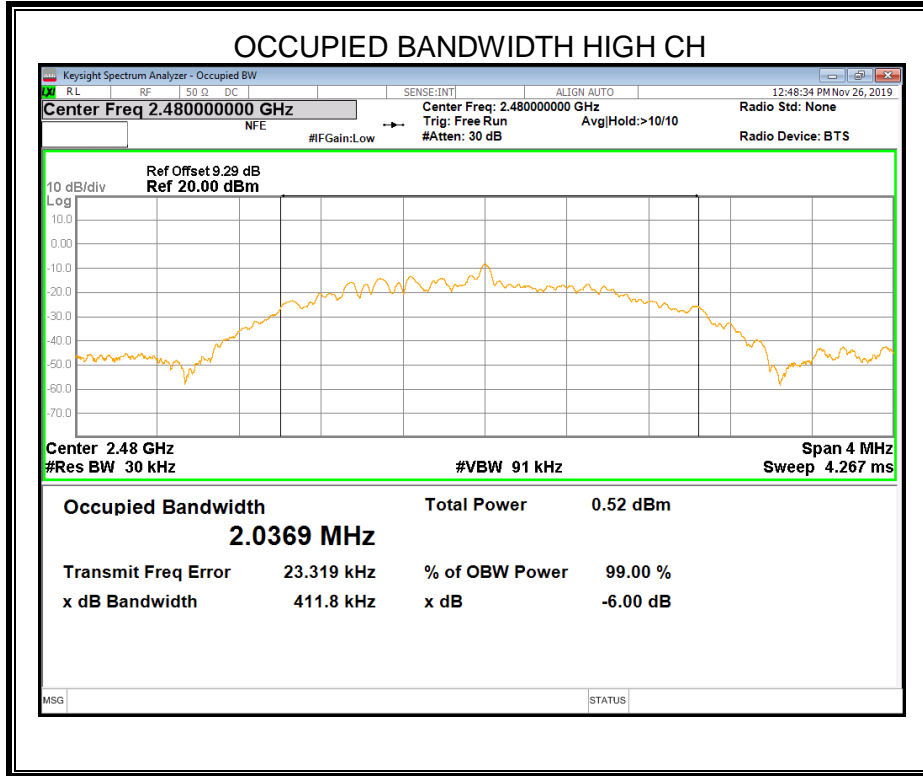



### 7.3. PEAK CONDUCTED OUTPUT POWER

#### LIMITS

CFR 47 FCC Part15 (15.247) Subpart C ISED RSS-247 ISSUE 2			
Section	Test Item	Limit	Frequency Range (MHz)
CFR 47 FCC 15.247(b)(3) ISED RSS-247 5.4 (d)	Peak Output Power	1 watt or 30dBm	2400-2483.5

#### TEST PROCEDURE

Place the EUT on the table and set it in the transmitting mode.  
Remove the antenna from the EUT and then connect a low loss RF cable from the antenna port to the Power sensor.  
Measure peak power each channel.

#### TEST SETUP

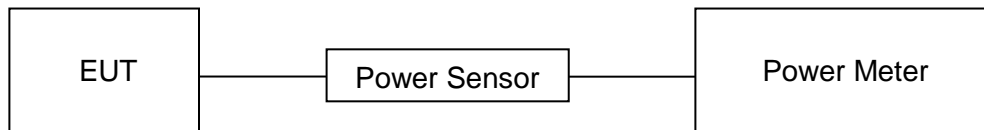

#### TEST ENVIRONMENT

Temperature	25.1°C	Relative Humidity	51%
Atmosphere Pressure	101kPa	Test Voltage	DC 3.7V



### 7.3.1. GFSK(1Mbps) MODE

Test Channel	Maximum Conducted Output Power(PK)	EIRP	LIMIT
	(dBm)	(dBm)	dBm
Low	-5.09	-2.68	30
Middle	-4.64	-2.23	30
High	-5.12	-2.71	30

### 7.3.2. GFSK(2Mbps) MODE

Test Channel	Maximum Conducted Output Power(PK)	EIRP	LIMIT
	(dBm)	(dBm)	dBm
Low	-5.15	-2.74	30
Middle	-4.66	-2.25	30
High	-5.14	-2.73	30

Note: EIRP=Maximum Conducted Output Power(PK) + Antenna Gain

## 7.4. POWER SPECTRAL DENSITY

### LIMITS

CFR 47 FCC Part15 (15.247) Subpart C ISED RSS-247 ISSUE 2			
Section	Test Item	Limit	Frequency Range (MHz)
CFR 47 FCC §15.247 (e) ISED RSS-247 5.2 (b)	Power Spectral Density	8 dBm in any 3 kHz band	2400-2483.5

### TEST PROCEDURE

Connect the UUT to the spectrum analyser and use the following settings:

Center Frequency	The center frequency of the channel under test
Detector	Peak
RBW	$3 \text{ kHz} \leq \text{RBW} \leq 100 \text{ kHz}$
VBW	$\geq 3 \times \text{RBW}$
Span	1.5 x DTS bandwidth
Trace	Max hold
Sweep time	Auto couple.

Allow trace to fully stabilize and use the peak marker function to determine the maximum amplitude level within the RBW.

If measured value exceeds limit, reduce RBW (no less than 3 kHz) and repeat.

### TEST SETUP

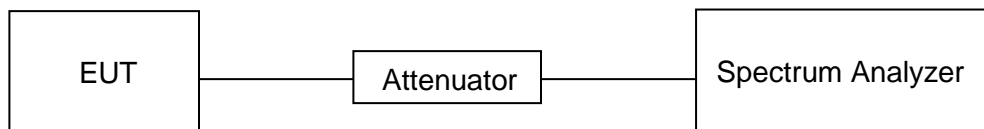



**TEST ENVIRONMENT**

Temperature	25.1°C	Relative Humidity	51%
Atmosphere Pressure	101kPa	Test Voltage	DC 3.7V

**RESULTS**

**7.4.1. GFSK(1Mbps) MODE**

Test Channel	Power Spectral Density (dBm/3kHz)	Limit (dBm/3kHz)	Result
Low	-20.226	8	PASS
Middle	-19.810	8	PASS
High	-20.294	8	PASS

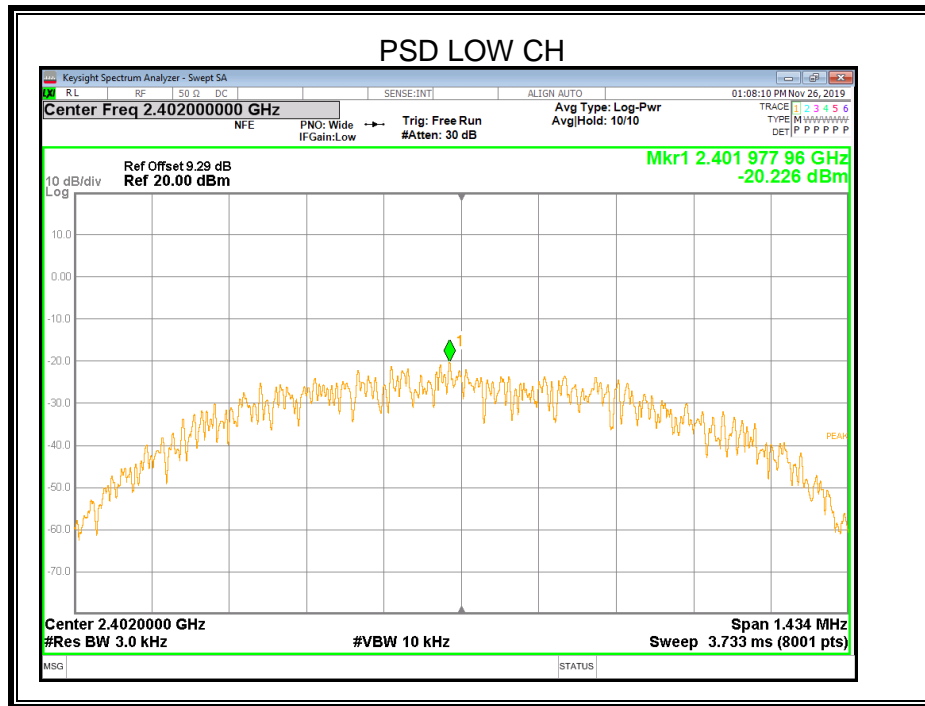

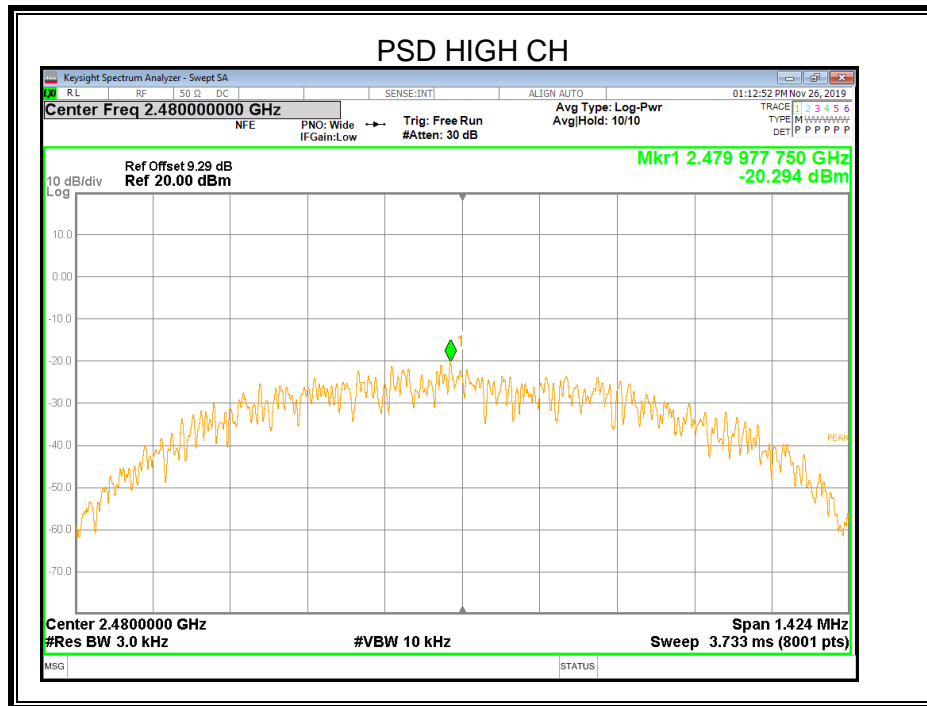
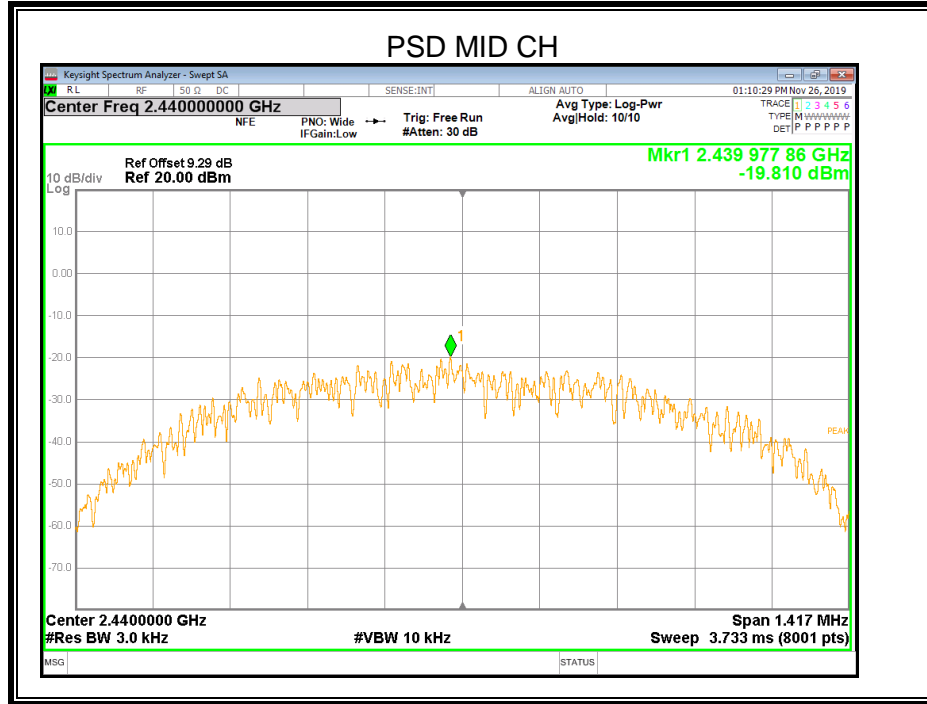



### 7.4.2. GFSK(2Mbps) MODE

Test Channel	Power Spectral Density (dBm/3kHz)	Limit (dBm/3kHz)	Result
Low	-22.987	8	PASS
Middle	-22.488	8	PASS
High	-22.863	8	PASS

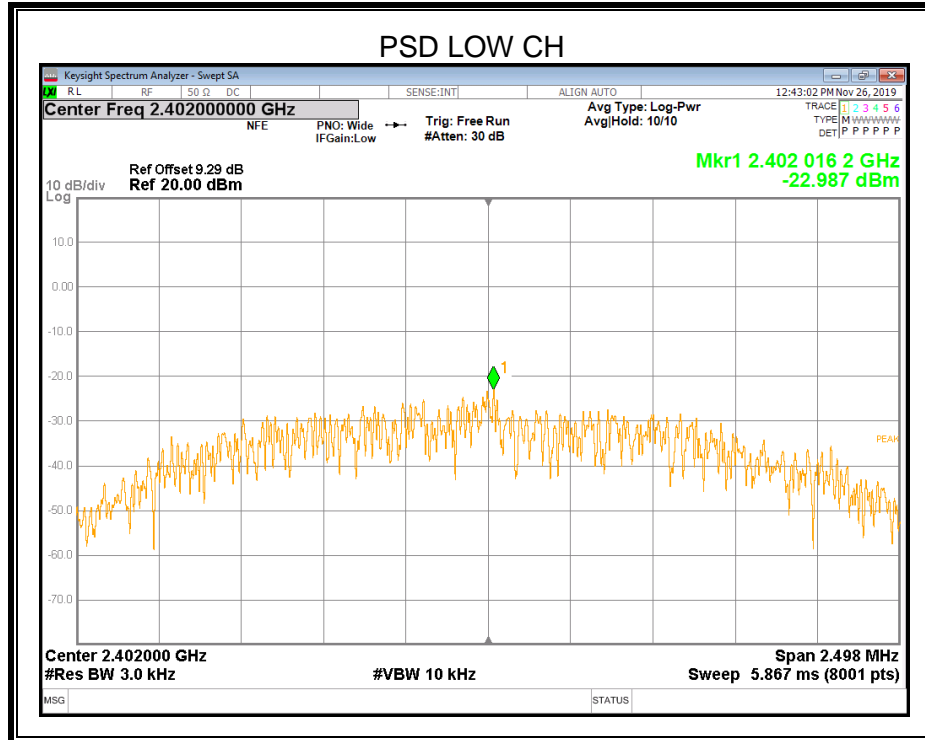

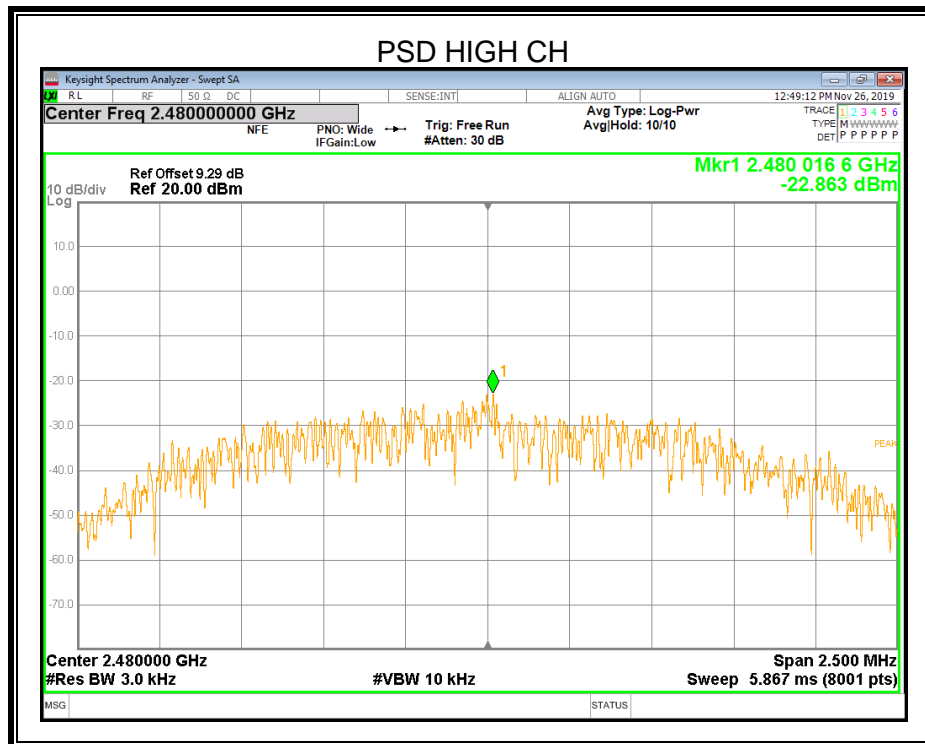
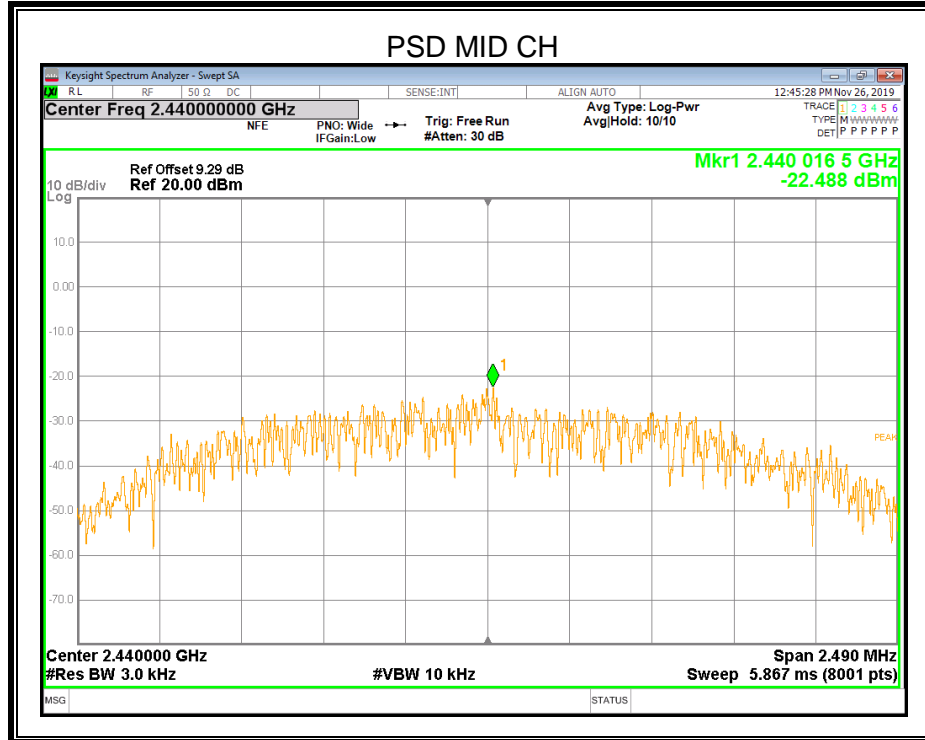





## 7.5. CONDUCTED BANDEGE AND SPURIOUS EMISSIONS

### LIMITS

CFR 47 FCC Part15 (15.247) Subpart C ISED RSS-247 ISSUE 2		
Section	Test Item	Limit
CFR 47 FCC §15.247 (d) ISED RSS-247 5.5	Conducted Bandedge and Spurious Emissions	at least 20 dB below that in the 100 kHz bandwidth within the band that contains the highest level of the desired power

### TEST PROCEDURE

Connect the UUT to the spectrum analyser and use the following settings:

Center Frequency	The center frequency of the channel under test
Detector	Peak
RBW	100kHz
VBW	$\geq 3 \times \text{RBW}$
Span	1.5 x DTS bandwidth
Trace	Max hold
Sweep time	Auto couple.

Use the peak marker function to determine the maximum PSD level.

Span	Set the center frequency and span to encompass frequency range to be measured
Detector	Peak
RBW	100kHz
VBW	$\geq 3 \times \text{RBW}$
measurement points	$\geq \text{span}/\text{RBW}$
Trace	Max hold
Sweep time	Auto couple.

Use the peak marker function to determine the maximum amplitude level.



**TEST SETUP**

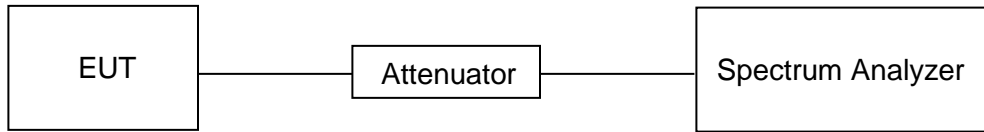

**TEST ENVIRONMENT**

Temperature	25.1°C	Relative Humidity	51%
Atmosphere Pressure	101kPa	Test Voltage	DC 3.7V

**RESULTS**

**7.5.1. GFSK(1Mbps) MODE**

**LOW CH BANDEDAGE**

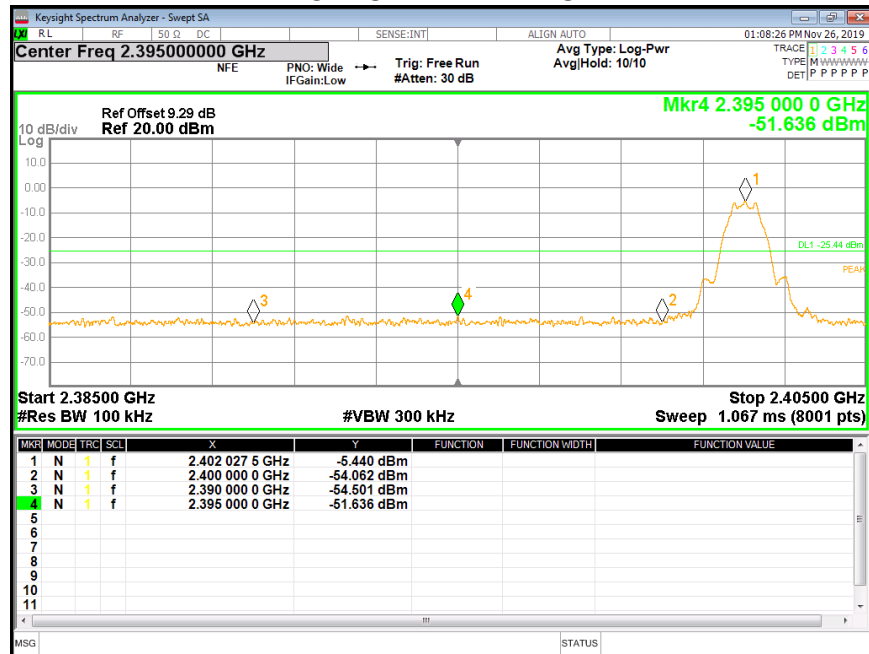



### LOW CH SPURIOUS EMISSIONS REFERENCE

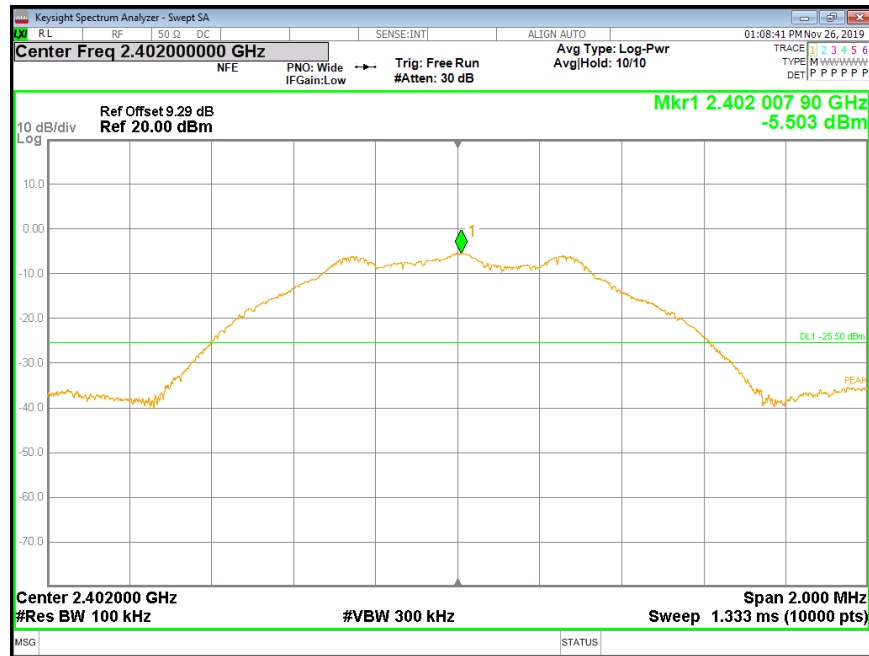

### LOW CH SPURIOUS EMISSIONS 30M-10G

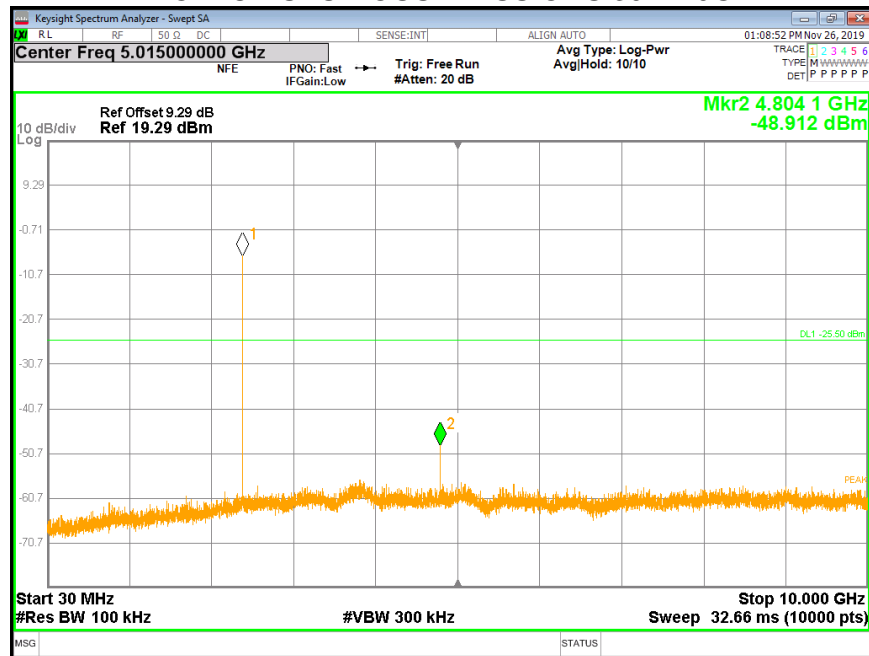



### LOW CH SPURIOUS EMISSIONS 10G-26G

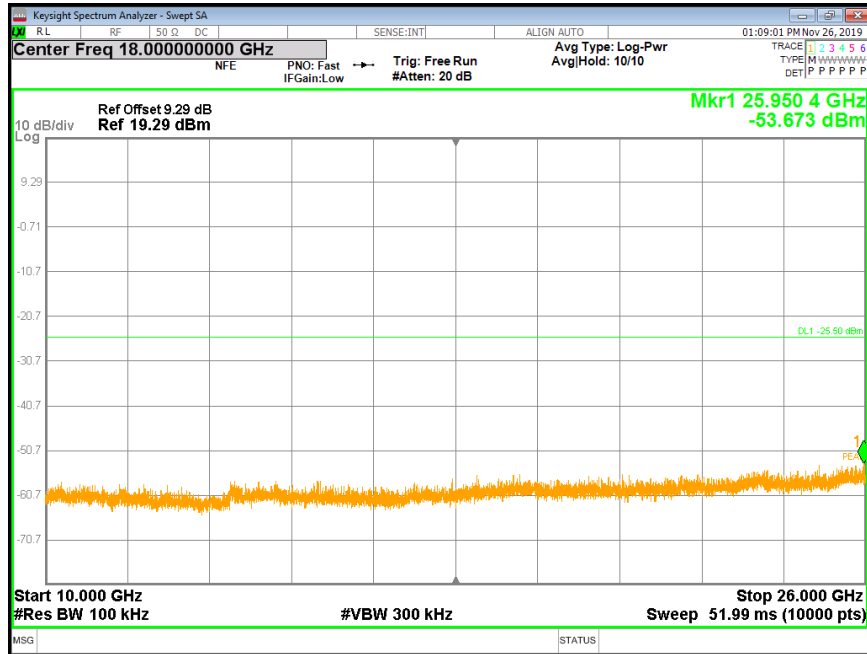

### MID CH SPURIOUS EMISSIONS REFERENCE

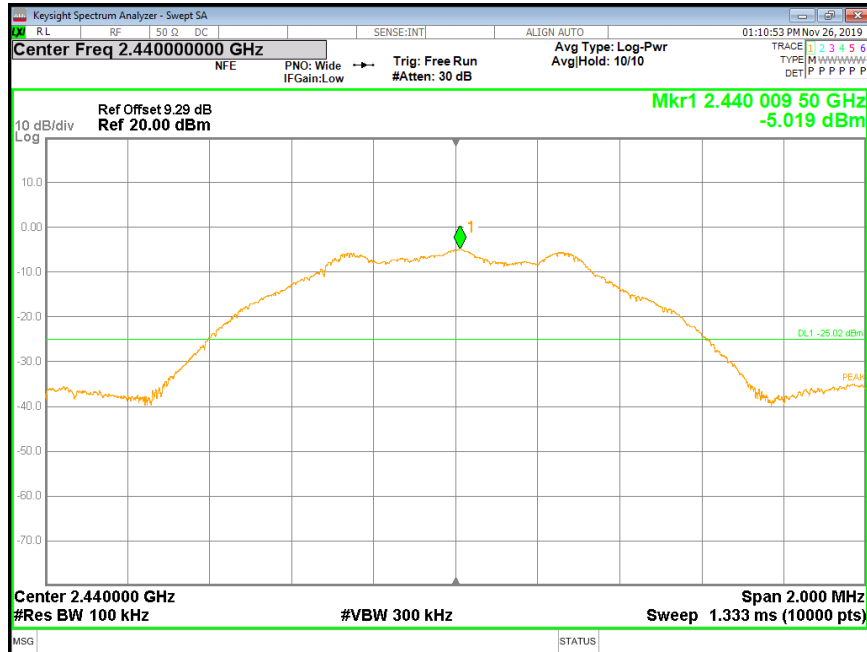



### MID CH SPURIOUS EMISSIONS 30M-10G

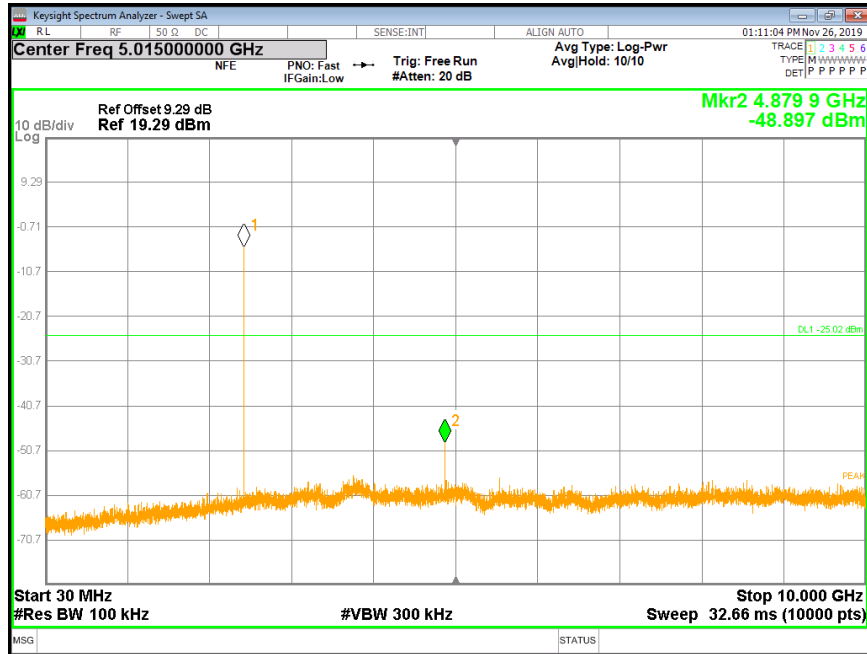

### MID CH SPURIOUS EMISSIONS 10G-26G

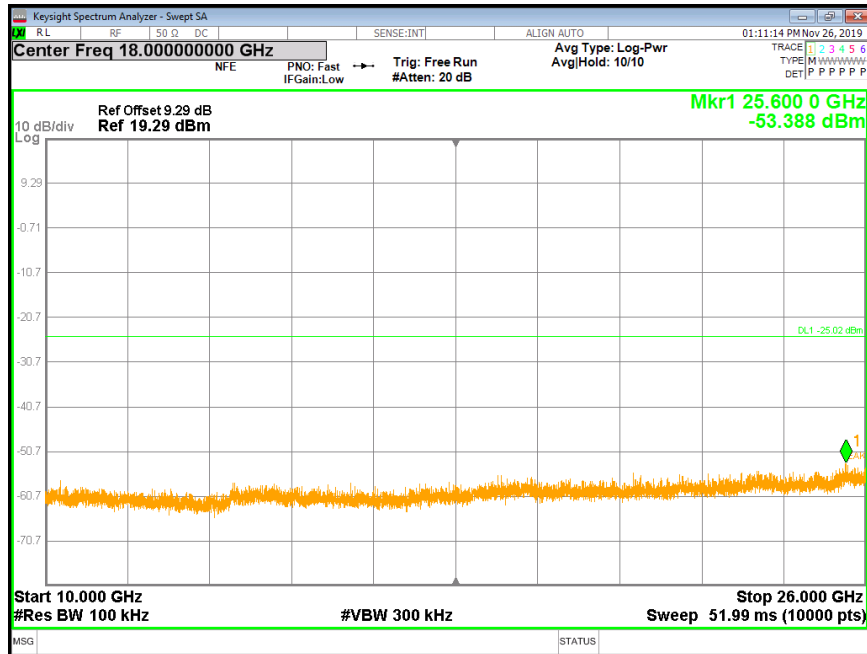



### HIGH CH BANDEDAGE

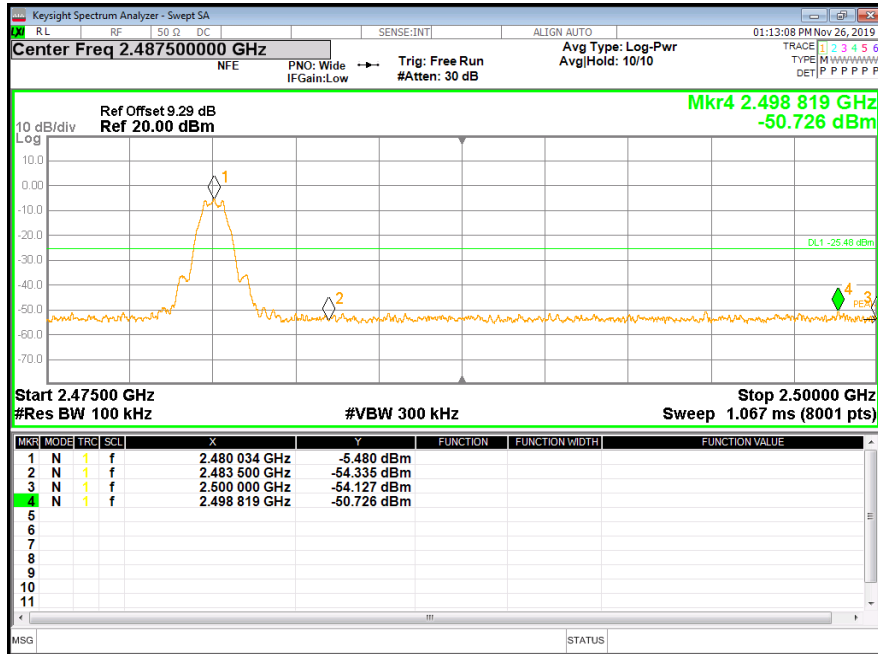

### HIGH CH SPURIOUS EMISSIONS REFERENCE

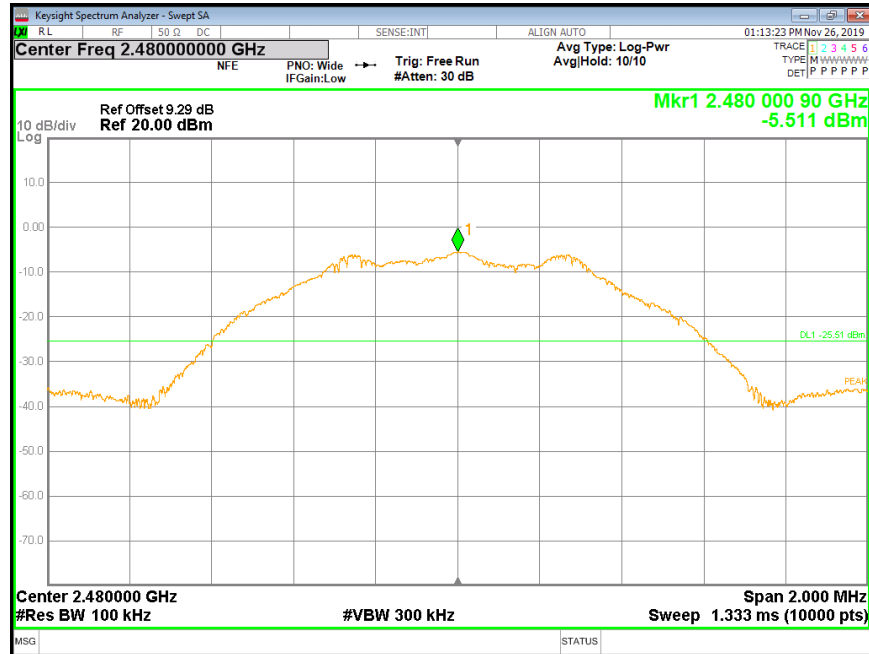



### HIGH CH SPURIOUS EMISSIONS 30M-10G

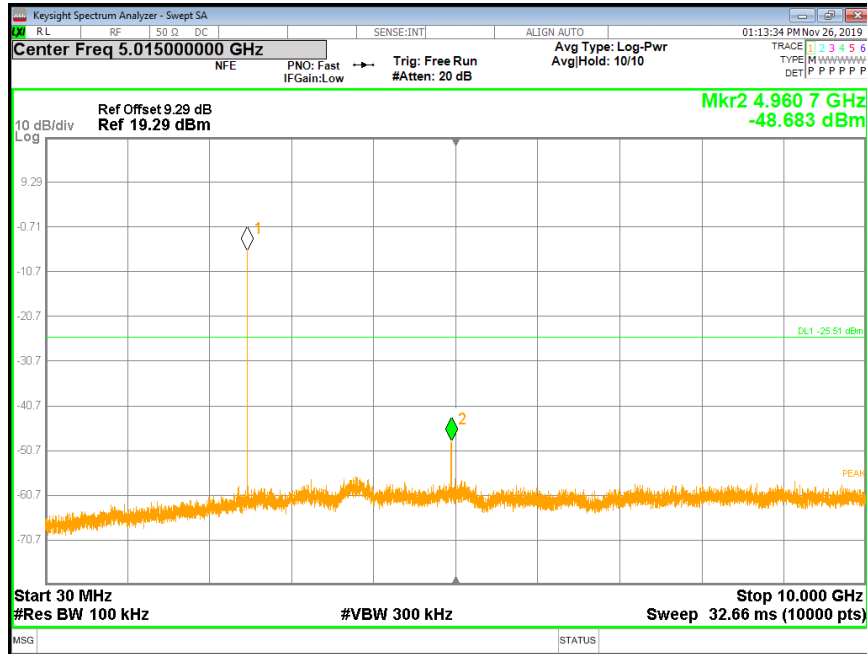

### HIGH CH SPURIOUS EMISSIONS 10G-26G

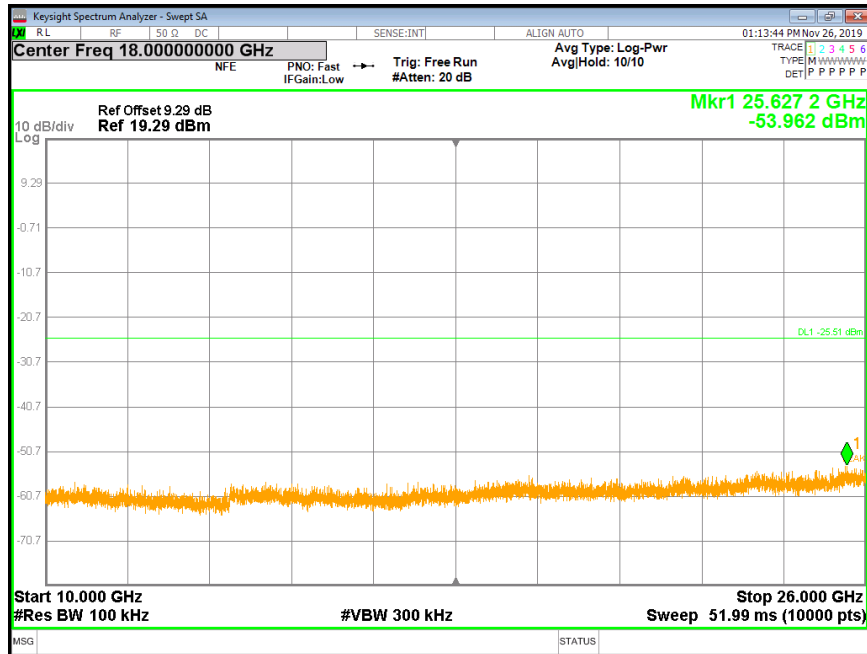



### 7.5.2. GFSK(2Mbps) MODE

#### LOW CH BANDEDGE

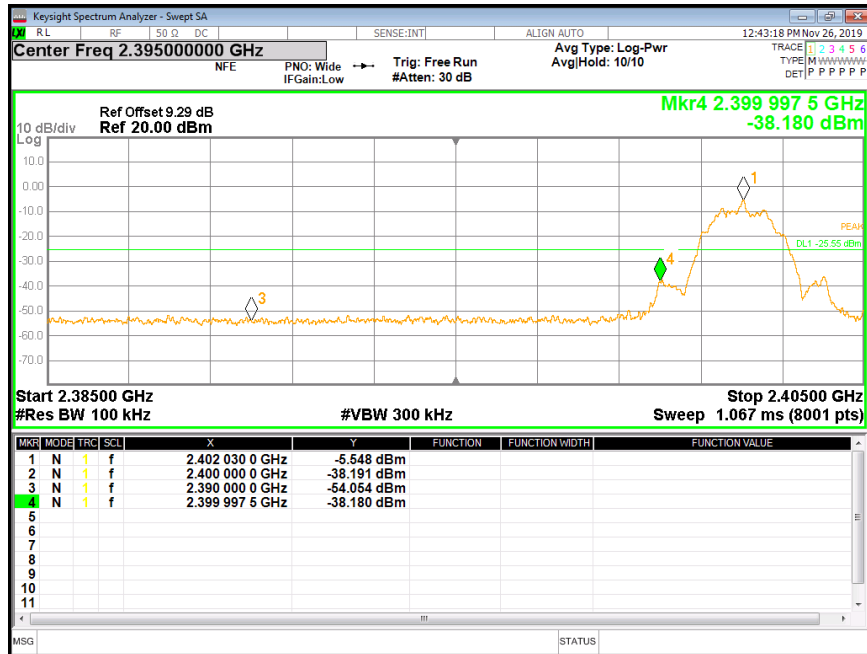

#### LOW CH SPURIOUS EMISSIONS REFERENCE

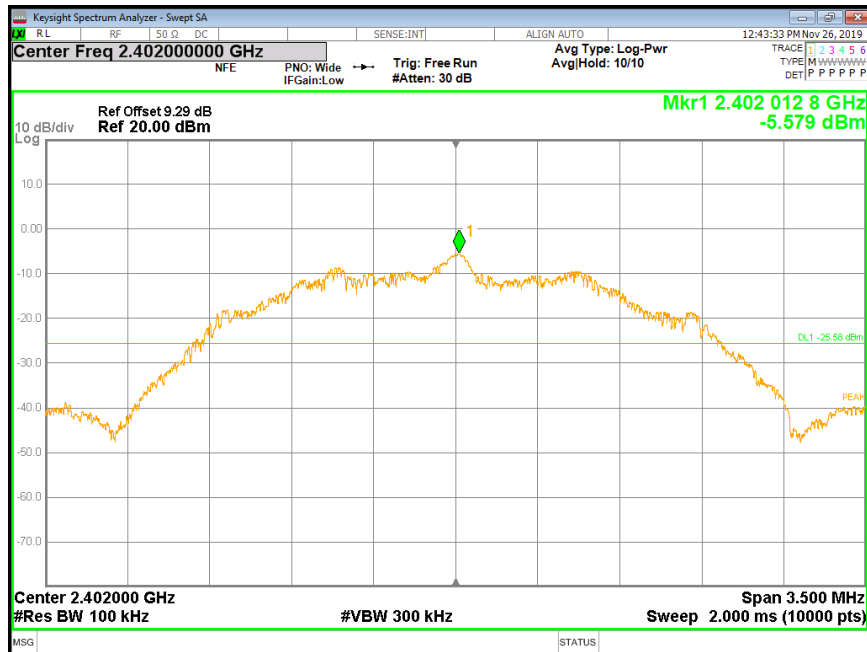





### LOW CH SPURIOUS EMISSIONS 30M-10G

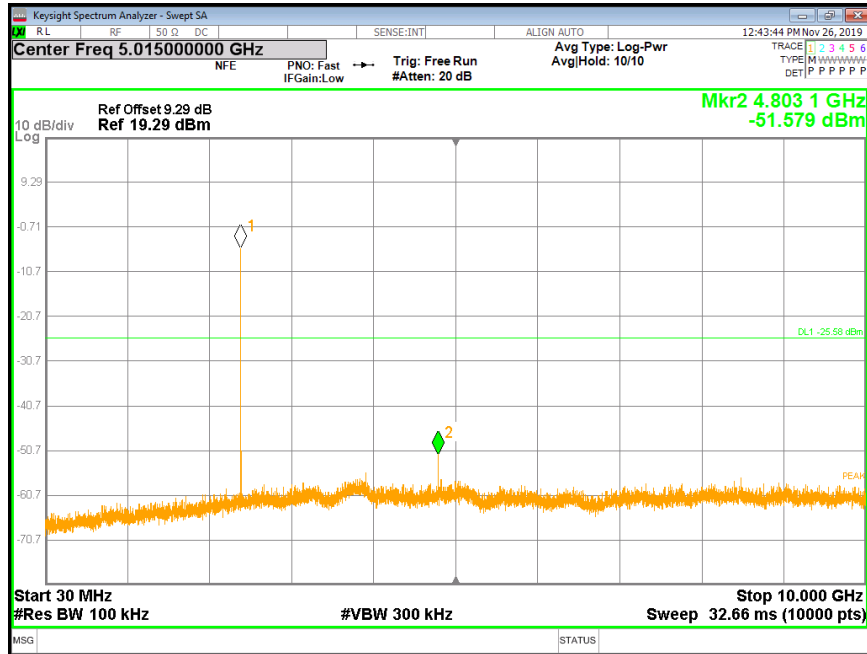

### LOW CH SPURIOUS EMISSIONS 10G-26G

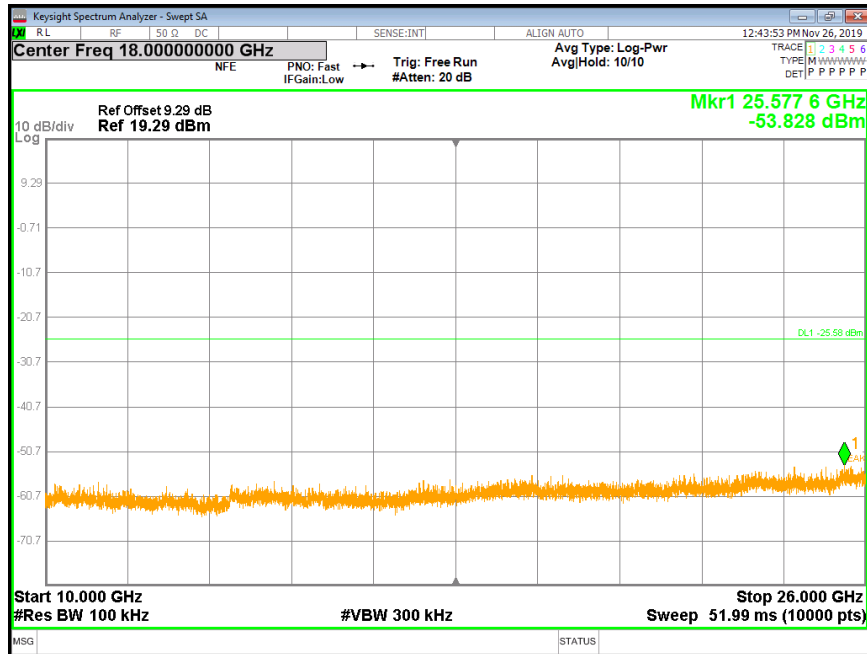



### MID CH SPURIOUS EMISSIONS REFERENCE

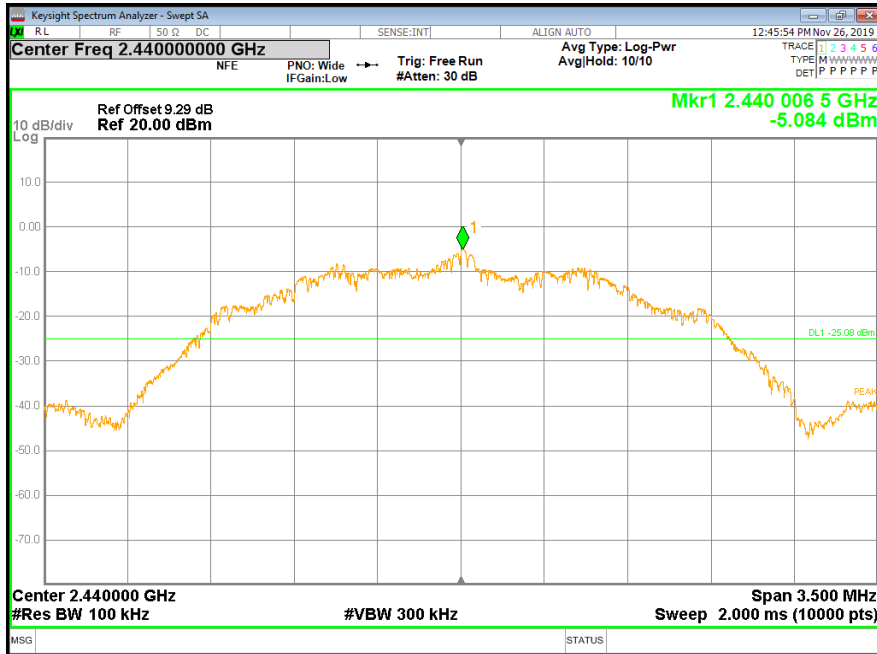

### MID CH SPURIOUS EMISSIONS 30M-10G

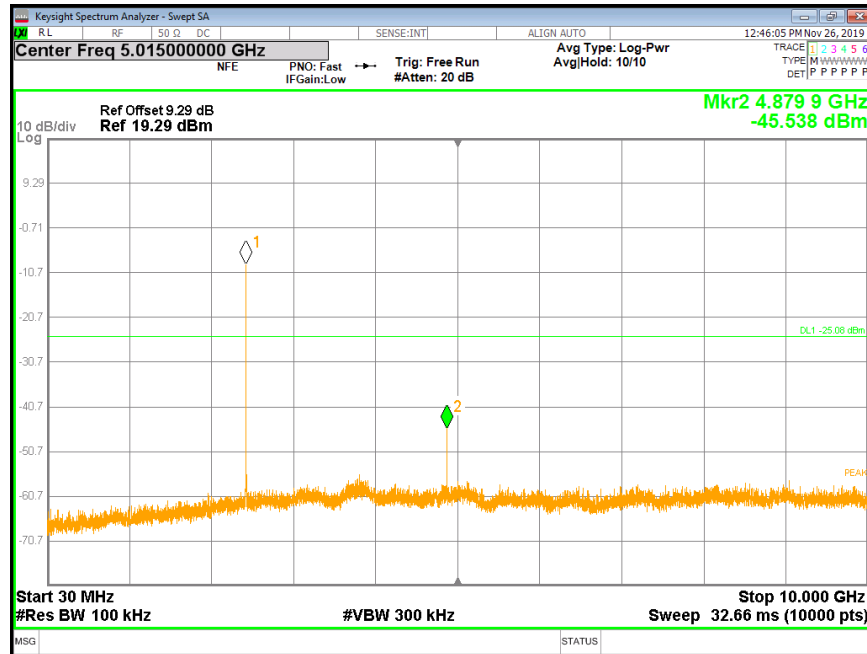



### MID CH SPURIOUS EMISSIONS 10G-26G

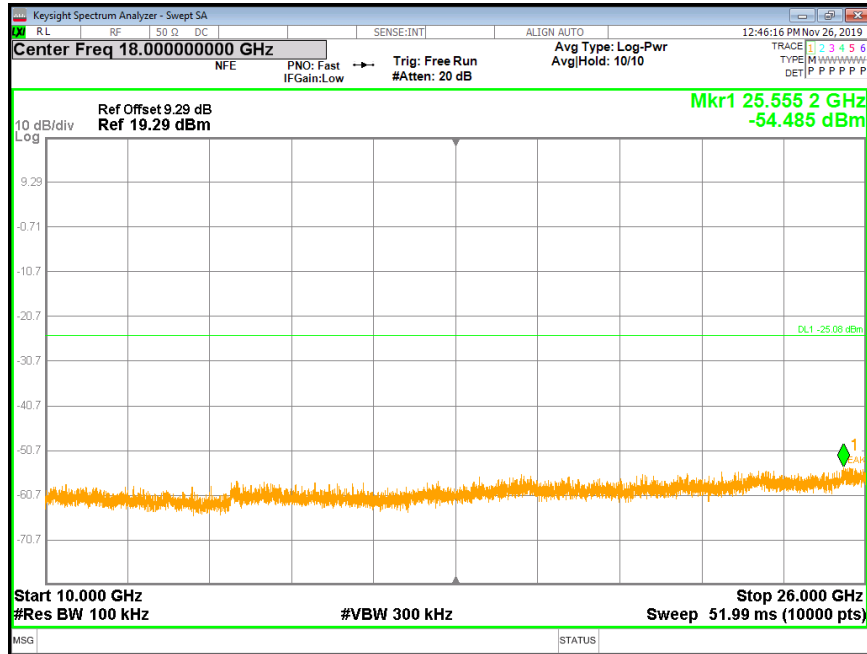

### HIGH CH BANDEDAGE

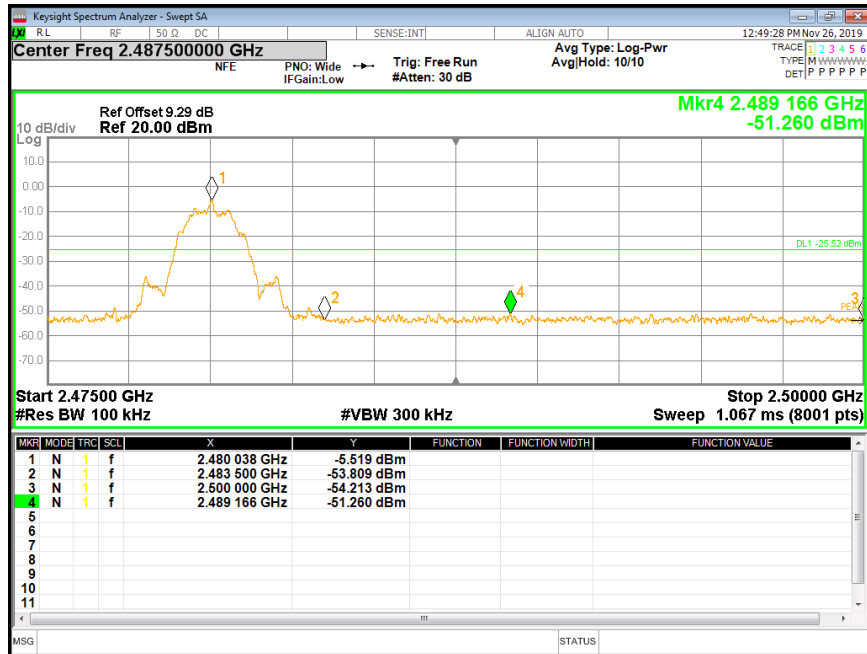



### HIGH CH SPURIOUS EMISSIONS REFERENCE

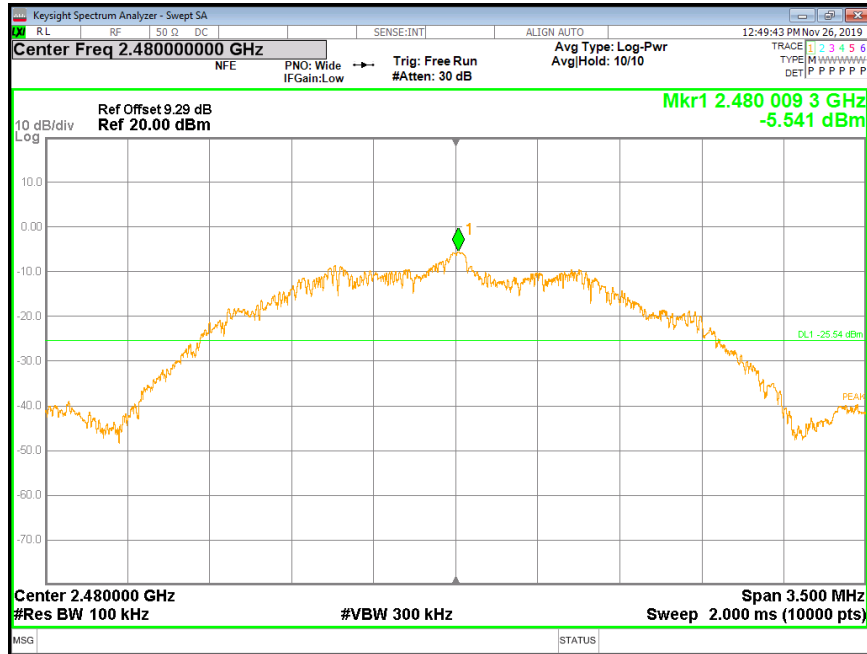

### HIGH CH SPURIOUS EMISSIONS 30M-10G

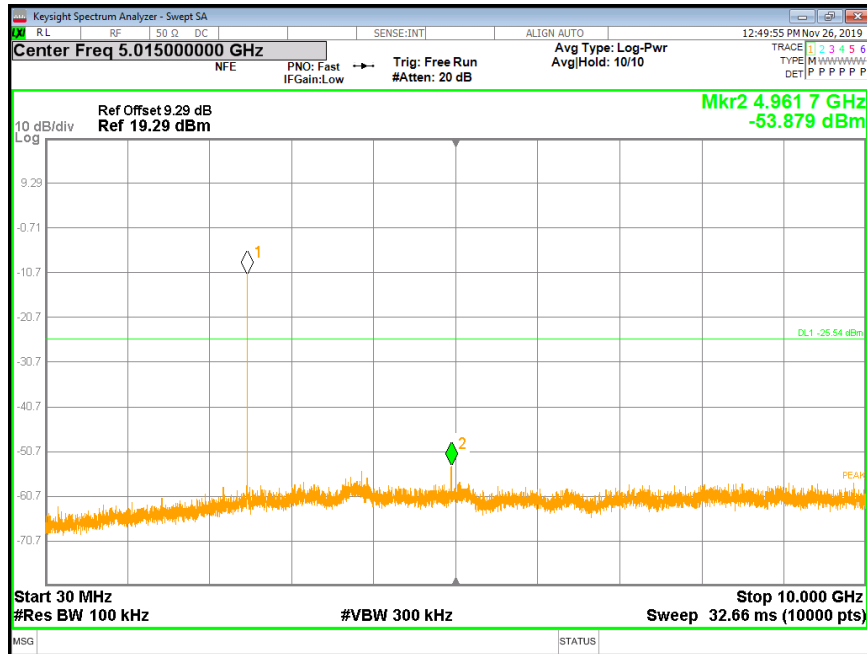



### HIGH CH SPURIOUS EMISSIONS 10G-26G

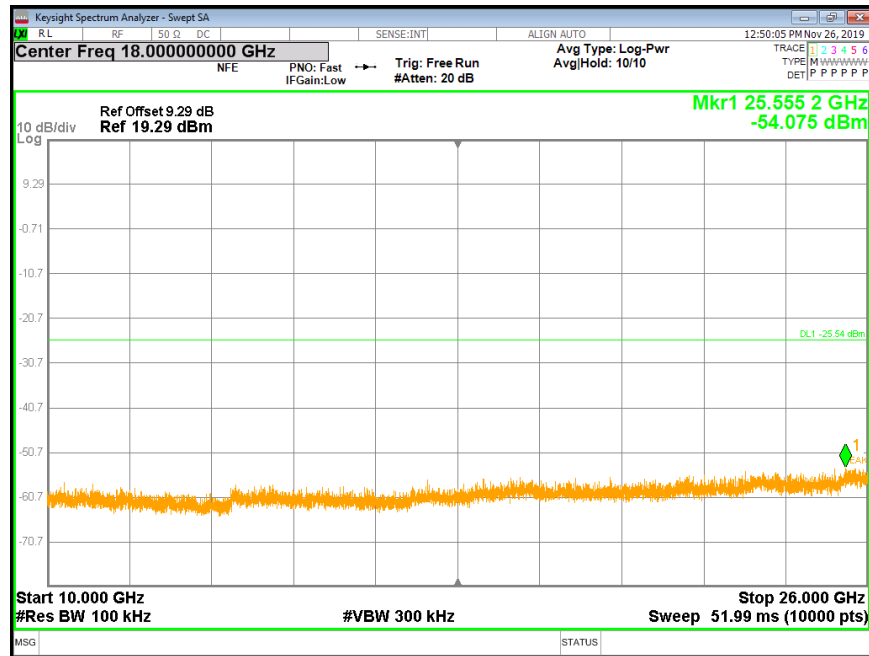



## 8. RADIATED TEST RESULTS

### LIMITS

Please refer to CFR 47 FCC §15.205 and §15.209

Please refer to ISED RSS-GEN Clause 8.9 and Clause 8.10

#### Radiation Disturbance Test Limit for FCC (Class B)(9kHz-1GHz)

Frequency (MHz)	Field Strength (microvolts/meter)	Measurement Distance (meters)
0.009~0.490	2400/F(kHz)	300
0.490~1.705	24000/F(kHz)	30
1.705~30.0	30	30
30~88	100	3
88~216	150	3
216~960	200	3
960~1000	500	3

Note: 1) At frequencies at or above 30 MHz, measurements may be performed at a distance other than what is specified provided: measurements are not made in the near field except where it can be shown that near field measurements are appropriate due to the characteristics of the device; and it can be demonstrated that the signal levels needed to be measured at the distance employed can be detected by the measurement equipment. Measurements shall not be performed at a distance greater than 30 meters unless it can be further demonstrated that measurements at a distance of 30 meters or less are impractical. When performing measurements at a distance other than that specified, the results shall be extrapolated to the specified distance using an extrapolation factor of 20 dB/decade (inverse linear-distance for field strength measurements; inverse-linear-distance-squared for power density measurements).

(2) At frequencies below 30 MHz, measurements may be performed at a distance closer than that specified in the regulations; however, an attempt should be made to avoid making measurements in the near field. Pending the development of an appropriate measurement procedure for measurements performed below 30 MHz, when performing measurements at a closer distance than specified, the results shall be extrapolated to the specified distance by either making measurements at a minimum of two distances on at least one radial to determine the proper extrapolation factor or by using the square of an inverse linear distance extrapolation factor (40 dB/decade). This paragraph (f) shall not apply to Access BPL devices operating below 30 MHz.

#### Radiation Disturbance Test Limit for FCC (Above 1G)

Frequency (MHz)	dB(uV/m) (at 3 meters)	
	Peak	Average
Above 1000	74	54

About Restricted bands of operation please refer to RSS-Gen section 8.10 and FCC §15.205 (a)

**TEST SETUP AND PROCEDURE**

Below 30MHz

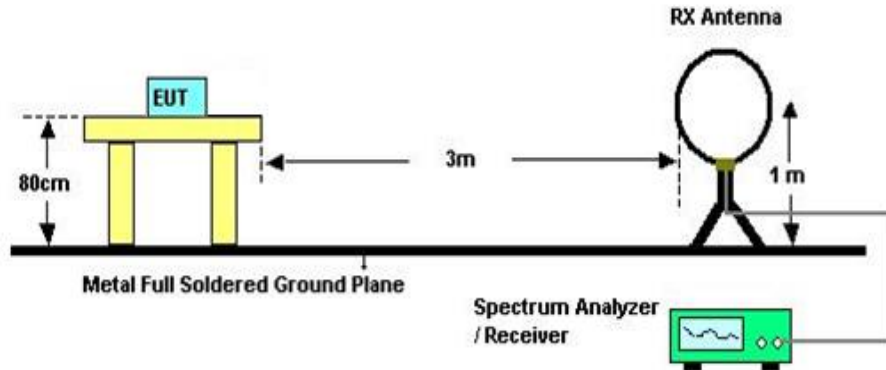

The setting of the spectrum analyser

RBW	200Hz (From 9kHz to 0.15MHz)/ 9kHz (From 0.15MHz to 30MHz)
VBW	200Hz (From 9kHz to 0.15MHz)/ 9kHz (From 0.15MHz to 30MHz)
Sweep	Auto
Detector	Peak/QP/ Average
Trace	Max hold

1. The testing follows the guidelines in ANSI C63.10-2013
2. The EUT was arranged to its worst case and then turntable (from 0 degree to 360 degrees) to find the maximum reading. A pre-amp and a high pass filter are used for the test in order to get better signal level. All 3 polarizations Horizontal, Face-on and Face-off of the antenna are set to make the measurement.
3. The EUT was placed on a turntable with 80cm above ground.
4. The EUT was set 3 meters from the interference receiving antenna, which was mounted on the top of a variable height antenna tower.
5. The radiated emission limits are based on measurements employing a CISPR quasi-peak detector except for the frequency bands 9-90 kHz, 110-490 kHz and above 1000 MHz. Radiated emission limits in these three bands are based on measurements employing an average detector.
6. For measurement below 1GHz, the initial step in collecting conducted emission data is a spectrum analyzer peak detector mode pre-scanning the measurement frequency range. Significant peaks are then marked and then Quasi Peak and average detector mode re-measured. If the emission level of the EUT measured by the peak detector is 3 dB lower than the applicable limit, the peak emission level will be reported. Otherwise, the emission measurement will be repeated using the quasi-peak and average detector and reported.
7. Although these tests were performed other than open field site, adequate comparison measurements were confirmed against 30m open are test site. Therefore sufficient tests were made to demonstrate that the alternative site produces results that correlate with the ones of tests made in an open field based on KDB 414788.

Below 1G and above 30MHz

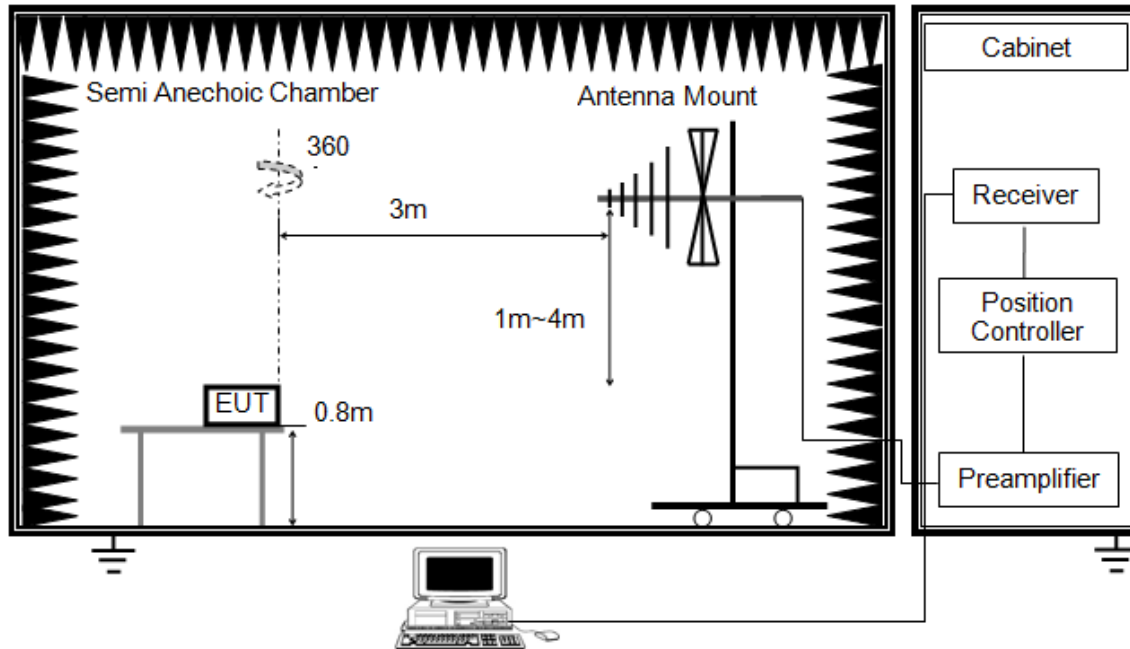

The setting of the spectrum analyser

RBW	120K
VBW	300K
Sweep	Auto
Detector	Peak/QP
Trace	Max hold

1. The testing follows the guidelines in ANSI C63.10-2013.
2. The EUT was arranged to its worst case and then tune the antenna tower (from 1 m to 4 m) and turntable (from 0 degree to 360 degrees) to find the maximum reading. A pre-amp and a high pass filter are used for the test in order to get better signal level. Both horizontal and vertical polarizations of the antenna are set to make the measurement.
3. The EUT was placed on a turntable with 80cm above ground.
4. The EUT was set 3 meters from the interference receiving antenna, which was mounted on the top of a variable height antenna tower.
5. For measurement below 1GHz, the initial step in collecting conducted emission data is a spectrum analyzer peak detector mode pre-scanning the measurement frequency range. Significant peaks are then marked and then Quasi Peak detector mode re-measured. If the emission level of the EUT measured by the peak detector is 3 dB lower than the applicable limit, the peak emission level will be reported. Otherwise, the emission measurement will be repeated using the quasi-peak detector and reported.



Above 1G

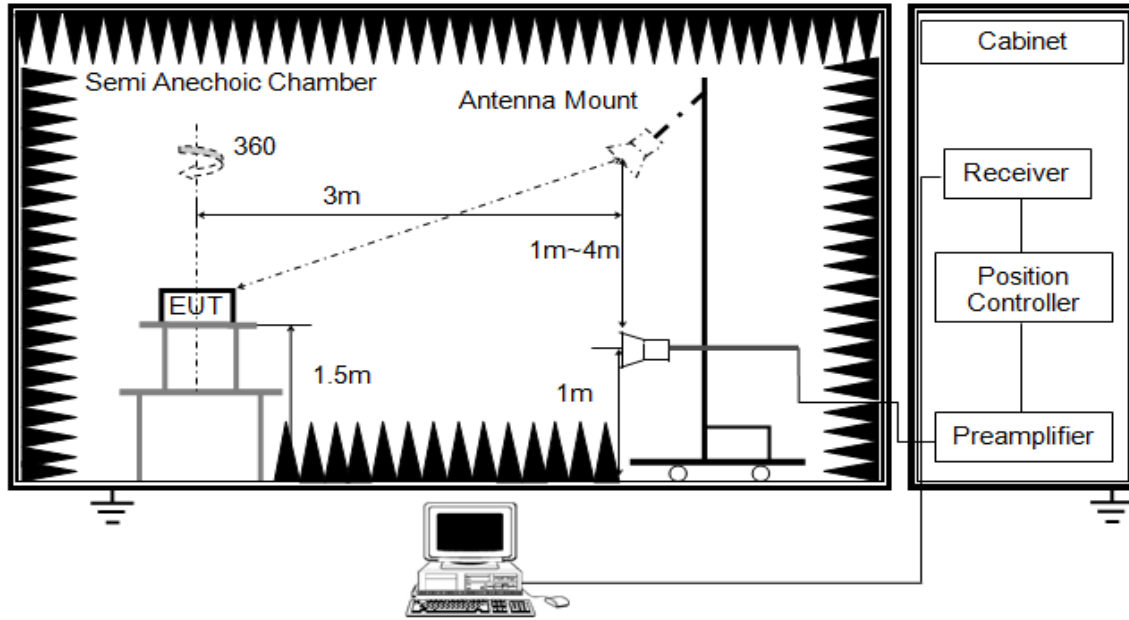

The setting of the spectrum analyser

RBW	1M
VBW	PEAK: 3M AVG: see note 6
Sweep	Auto
Detector	Peak
Trace	Max hold

1. The testing follows the guidelines in ANSI C63.10-2013.
2. The EUT was arranged to its worst case and then tune the antenna tower (1.5 m) and turntable (from 0 degree to 360 degrees) to find the maximum reading. A pre-amp and a high pass filter are used for the test in order to get better signal level. Both horizontal and vertical polarizations of the antenna are set to make the measurement.
3. The EUT was placed on a turntable with 1.5m above ground.
4. The EUT was set 3 meters from the interference receiving antenna, which was mounted on the top of a variable height antenna tower.
5. For measurement above 1GHz, the emission measurement will be measured by the peak detector. This peak level, once corrected, must comply with the limit specified in Section 15.209.
6. For measurements above 1 GHz the resolution bandwidth is set to 1 MHz, then the video bandwidth is set to 3 MHz for peak measurements and 1 MHz resolution bandwidth with 1/T video bandwidth with peak detector for average measurements. For the Duty Cycle and Correction Factor please refer to clause 7.1.ON TIME AND DUTY CYCLE.

X axis, Y axis, Z axis positions:

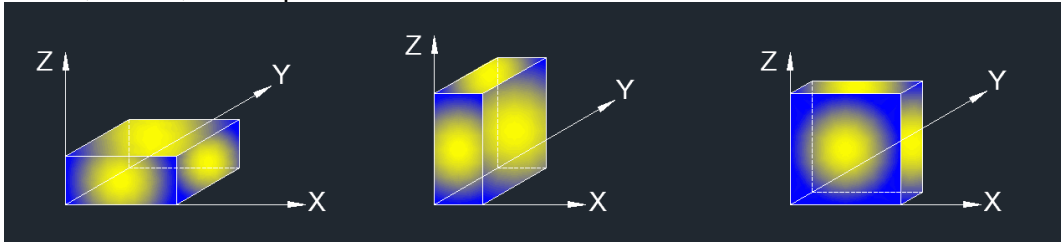

Note 1: For radiated test, EUT in each of three orthogonal axis emissions had been tested, but only the worst case (X axis) data recorded in the report.

Note 2: The EUT was fully exercised with external accessories during the test. In the case of multiple accessory external ports, an external accessory shall be connected to one of each type of port.

#### **TEST ENVIRONMENT**

Temperature	24.7°C	Relative Humidity	58%
Atmosphere Pressure	101kPa	Test Voltage	DC 3.7V

#### **RESULTS**



## 8.1. RESTRICTED BANDEGE

### 8.1.1. GFSK(1Mbps) MODE

#### RESTRICTED BANDEGE (LOW CHANNEL, HORIZONTAL)

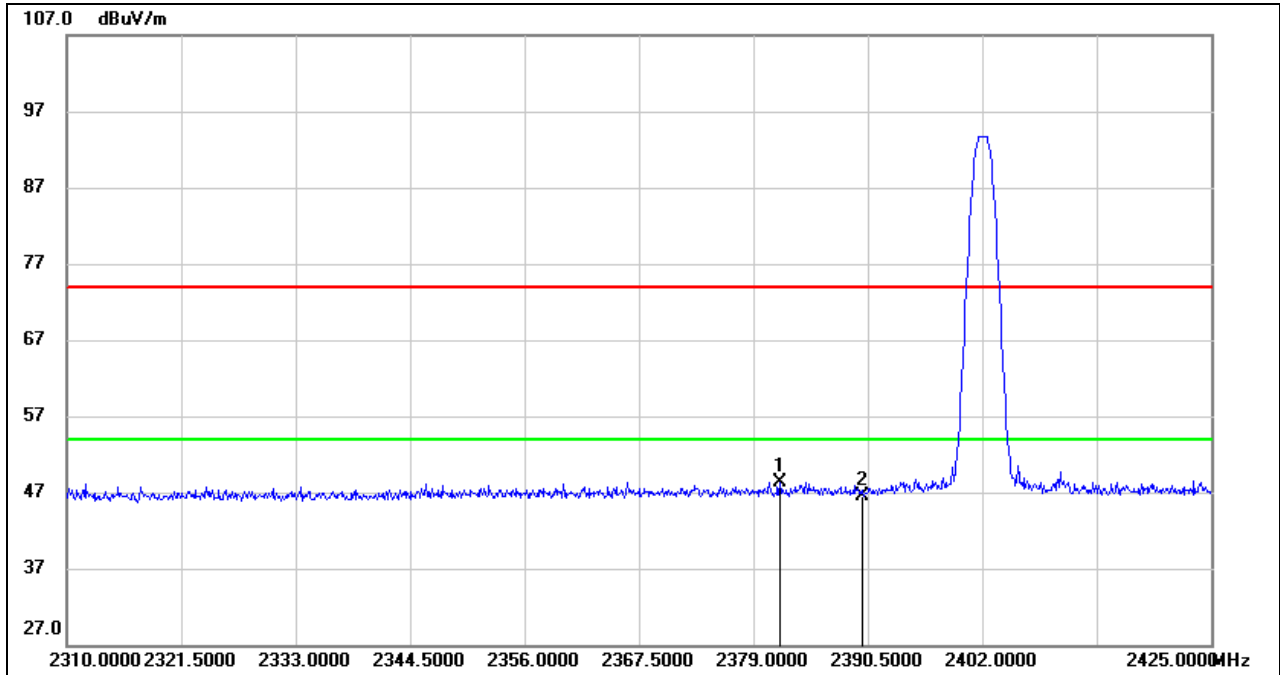

No.	Frequency (MHz)	Reading (dBuV)	Correct (dB/m)	Result (dBuV/m)	Limit (dBuV/m)	Margin (dB)	Remark
1	2381.645	15.38	32.92	48.30	74.00	-25.70	peak
2	2390.000	13.62	32.94	46.56	74.00	-27.44	peak

- Note: 1. Measurement = Reading Level + Correct Factor.  
 2. If Peak Result complies with AV limit, AV Result is deemed to comply with AV limit.  
 3. Peak: Peak detector.  
 4. Only the worst case emission will be recorder, if it complies with the limit, the other emissions deemed to comply with the limit.



**RESTRICTED BANDEDGE (LOW CHANNEL, VERTICAL)**

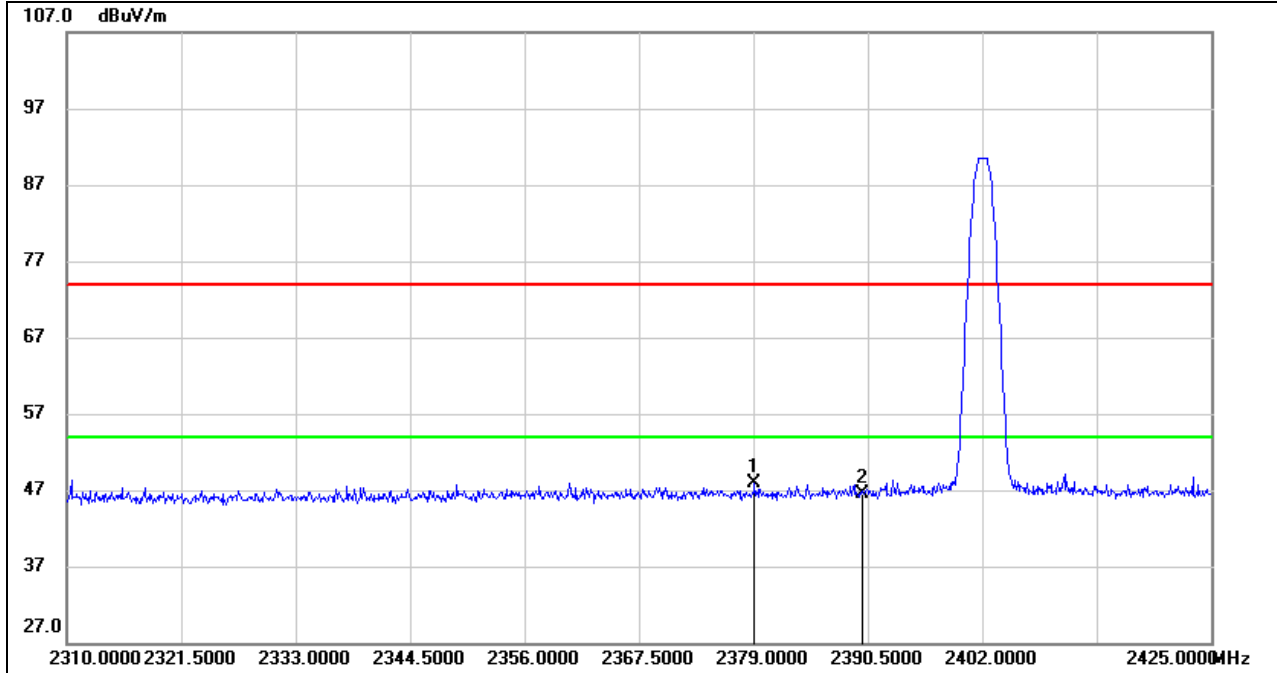

No.	Frequency (MHz)	Reading (dBuV)	Correct (dB/m)	Result (dBuV/m)	Limit (dBuV/m)	Margin (dB)	Remark
1	2379.115	14.90	32.91	47.81	74.00	-26.19	peak
2	2390.000	13.58	32.94	46.52	74.00	-27.48	peak

- Note: 1. Measurement = Reading Level + Correct Factor.  
 2. If Peak Result complies with AV limit, AV Result is deemed to comply with AV limit.  
 3. Peak: Peak detector.  
 4. Only the worst case emission will be recorder, if it complies with the limit, the other emissions deemed to comply with the limit.



**RESTRICTED BANDEDGE (HIGH CHANNEL, HORIZONTAL)**

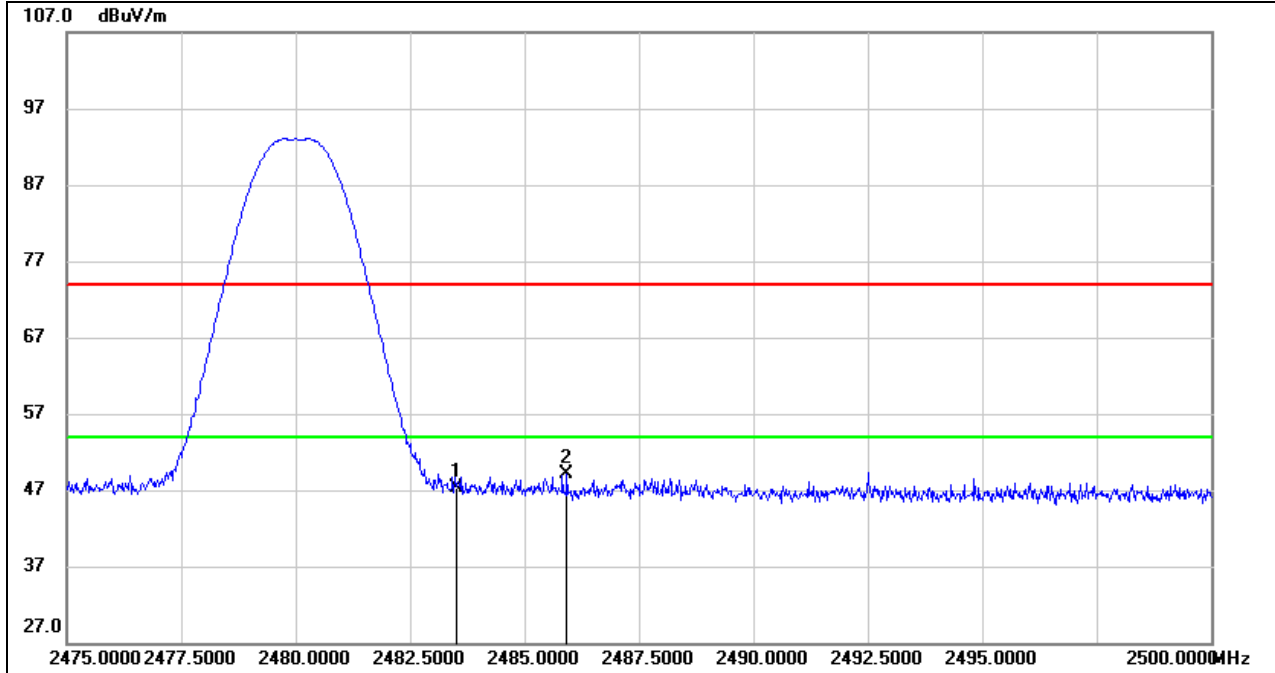

No.	Frequency (MHz)	Reading (dBuV)	Correct (dB/m)	Result (dBuV/m)	Limit (dBuV/m)	Margin (dB)	Remark
1	2483.500	13.82	33.58	47.40	74.00	-26.60	peak
2	2485.925	15.48	33.59	49.07	74.00	-24.93	peak

- Note: 1. Measurement = Reading Level + Correct Factor.  
 2. If Peak Result complies with AV limit, AV Result is deemed to comply with AV limit.  
 3. Peak: Peak detector.  
 4. Only the worst case emission will be recorder, if it complies with the limit, the other emissions deemed to comply with the limit.



**RESTRICTED BANDEGE (HIGH CHANNEL, VERTICAL)**

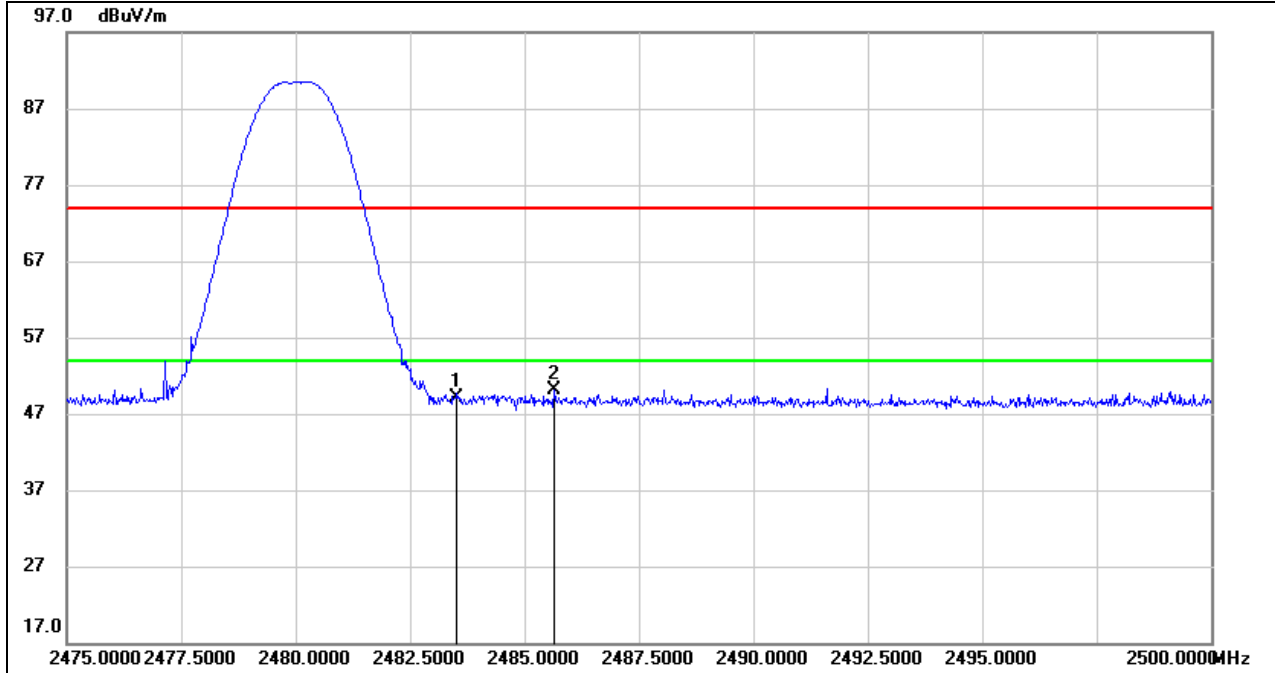

No.	Frequency (MHz)	Reading (dBuV)	Correct (dB/m)	Result (dBuV/m)	Limit (dBuV/m)	Margin (dB)	Remark
1	2483.500	15.51	33.58	49.09	74.00	-24.91	peak
2	2485.650	16.47	33.59	50.06	74.00	-23.94	peak

Note: 1. Measurement = Reading Level + Correct Factor.  
 2. If Peak Result complies with AV limit, AV Result is deemed to comply with AV limit.  
 3. Peak: Peak detector.  
 4. Only the worst case emission will be recorder, if it complies with the limit, the other emissions deemed to comply with the limit.



### 8.1.2. GFSK(2Mbps) MODE

#### RESTRICTED BANDEDGE (LOW CHANNEL, HORIZONTAL)

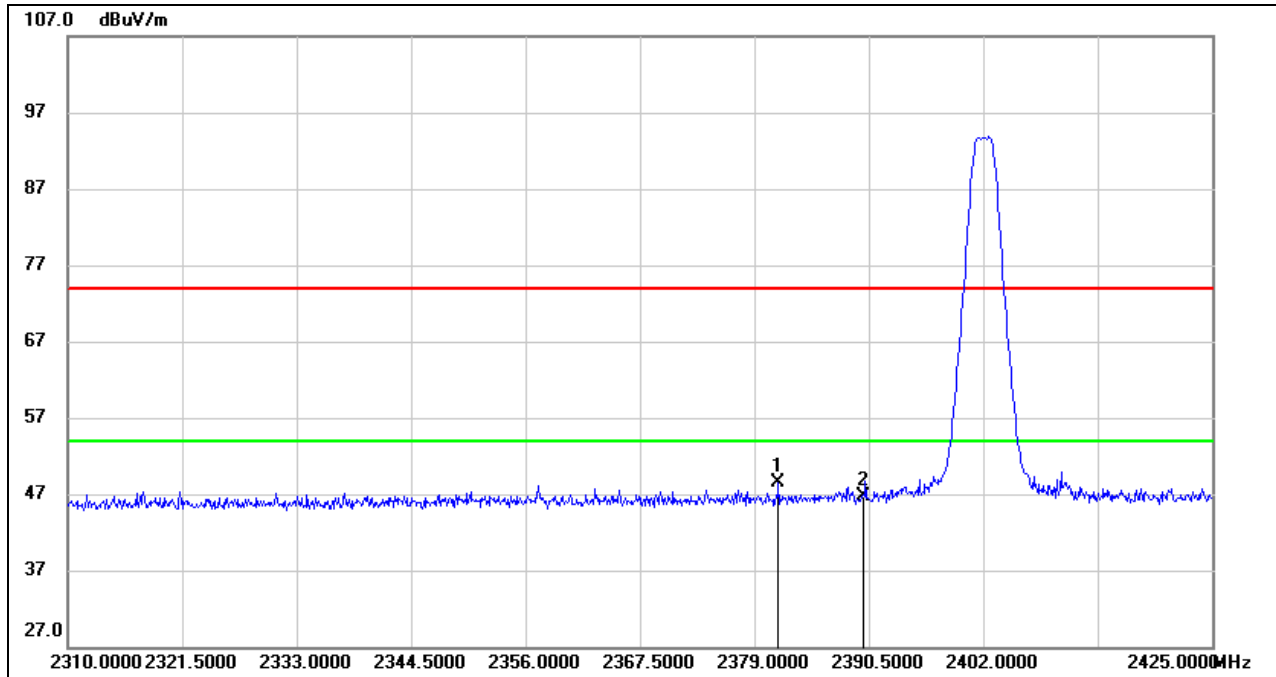

No.	Frequency (MHz)	Reading (dBuV)	Correct (dB/m)	Result (dBuV/m)	Limit (dBuV/m)	Margin (dB)	Remark
1	2381.415	15.50	32.92	48.42	74.00	-25.58	peak
2	2390.000	13.73	32.94	46.67	74.00	-27.33	peak

Note: 1. Measurement = Reading Level + Correct Factor.  
 2. If Peak Result complies with AV limit, AV Result is deemed to comply with AV limit.  
 3. Peak: Peak detector.  
 4. Only the worst case emission will be recorder, if it complies with the limit, the other emissions deemed to comply with the limit.



**RESTRICTED BANDEDGE (LOW CHANNEL, VERTICAL)**

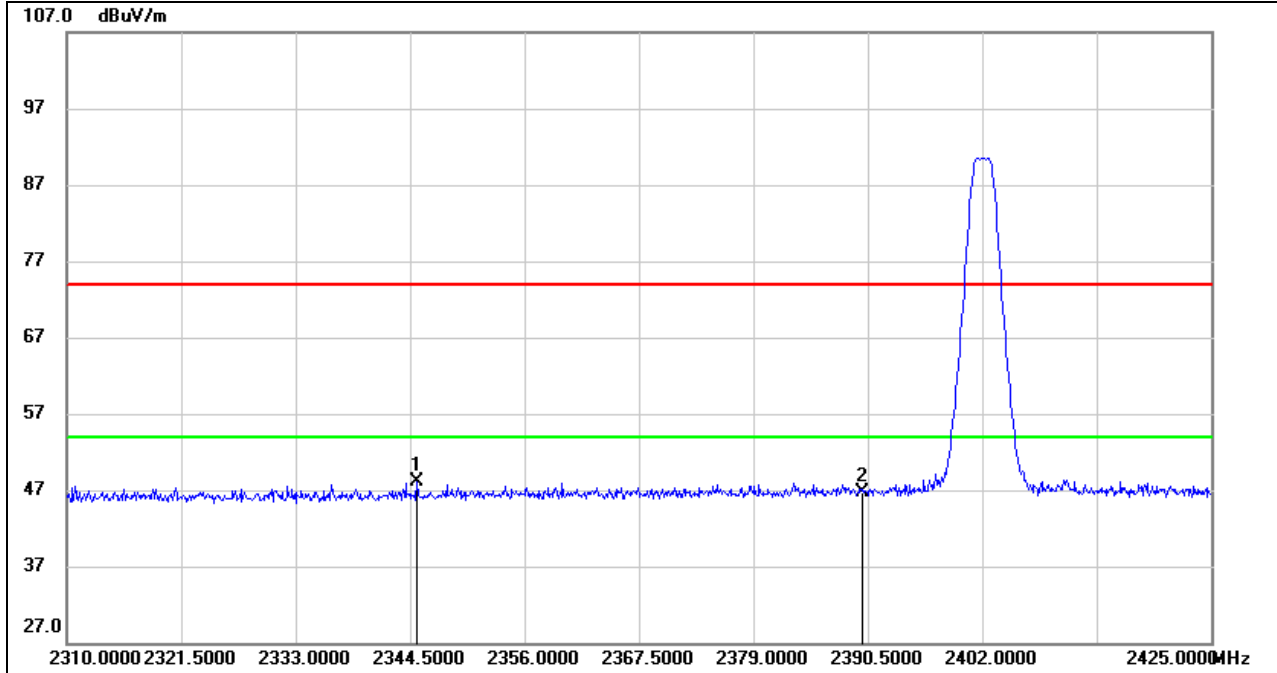

No.	Frequency (MHz)	Reading (dBuV)	Correct (dB/m)	Result (dBuV/m)	Limit (dBuV/m)	Margin (dB)	Remark
1	2345.190	15.29	32.79	48.08	74.00	-25.92	peak
2	2390.000	13.83	32.94	46.77	74.00	-27.23	peak

- Note: 1. Measurement = Reading Level + Correct Factor.  
 2. If Peak Result complies with AV limit, AV Result is deemed to comply with AV limit.  
 3. Peak: Peak detector.  
 4. Only the worst case emission will be recorder, if it complies with the limit, the other emissions deemed to comply with the limit.





**RESTRICTED BANDEDGE (HIGH CHANNEL, HORIZONTAL)**

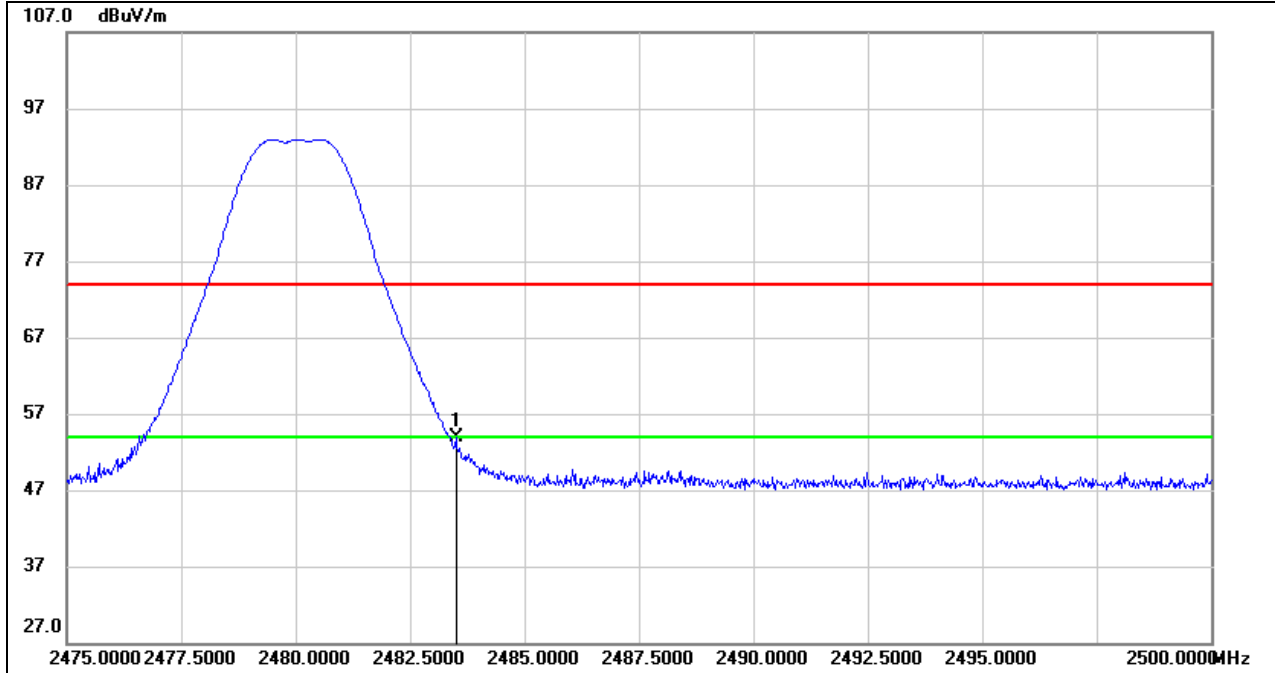

No.	Frequency (MHz)	Reading (dBuV)	Correct (dB/m)	Result (dBuV/m)	Limit (dBuV/m)	Margin (dB)	Remark
1	2483.500	20.34	33.58	53.92	74.00	-20.08	peak

- Note: 1. Measurement = Reading Level + Correct Factor.  
2. If Peak Result complies with AV limit, AV Result is deemed to comply with AV limit.  
3. Peak: Peak detector.  
4. Only the worst case emission will be recorder, if it complies with the limit, the other emissions deemed to comply with the limit.



**RESTRICTED BANDEDGE (HIGH CHANNEL, VERTICAL)**

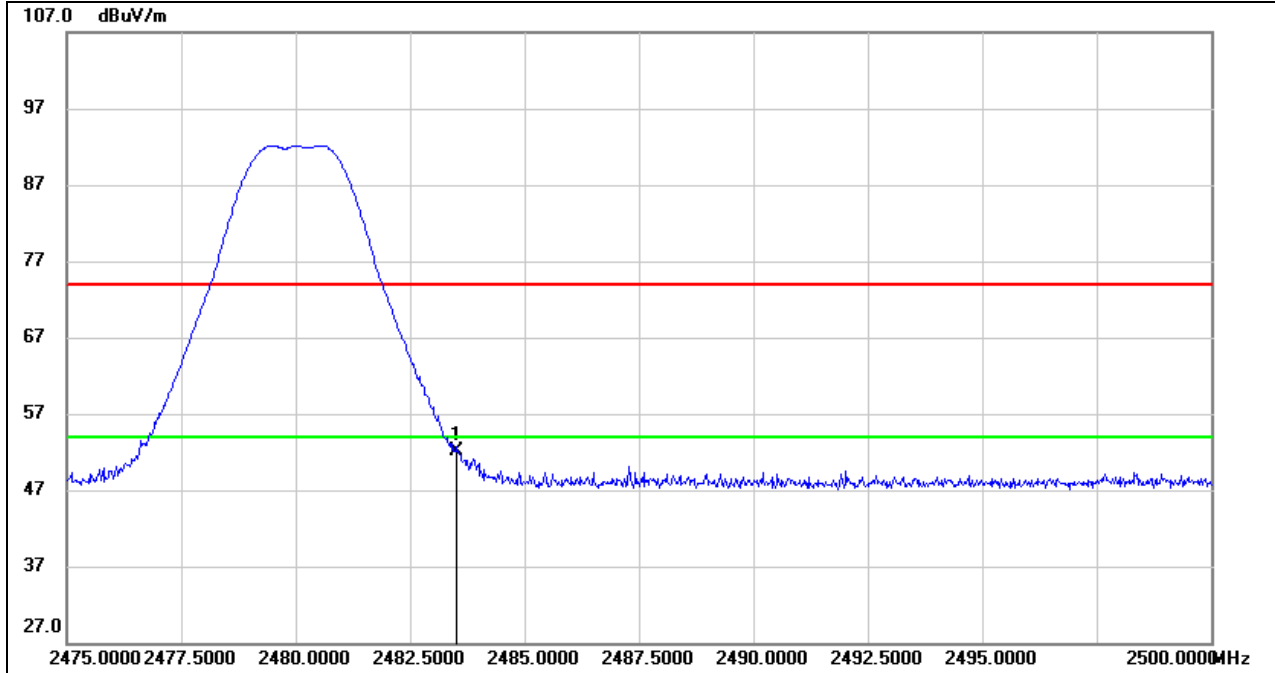

No.	Frequency (MHz)	Reading (dBuV)	Correct (dB/m)	Result (dBuV/m)	Limit (dBuV/m)	Margin (dB)	Remark
1	2483.500	18.43	33.58	52.01	74.00	-21.99	peak

- Note:
1. Measurement = Reading Level + Correct Factor.
  2. If Peak Result complies with AV limit, AV Result is deemed to comply with AV limit.
  3. Peak: Peak detector.
  4. Only the worst case emission will be recorder, if it complies with the limit, the other emissions deemed to comply with the limit.



## 8.2. SPURIOUS EMISSIONS (1~3GHz)

### 8.2.1. GFSK(1Mbps) MODE

#### HARMONICS AND SPURIOUS EMISSIONS (LOW CHANNEL, HORIZONTAL)

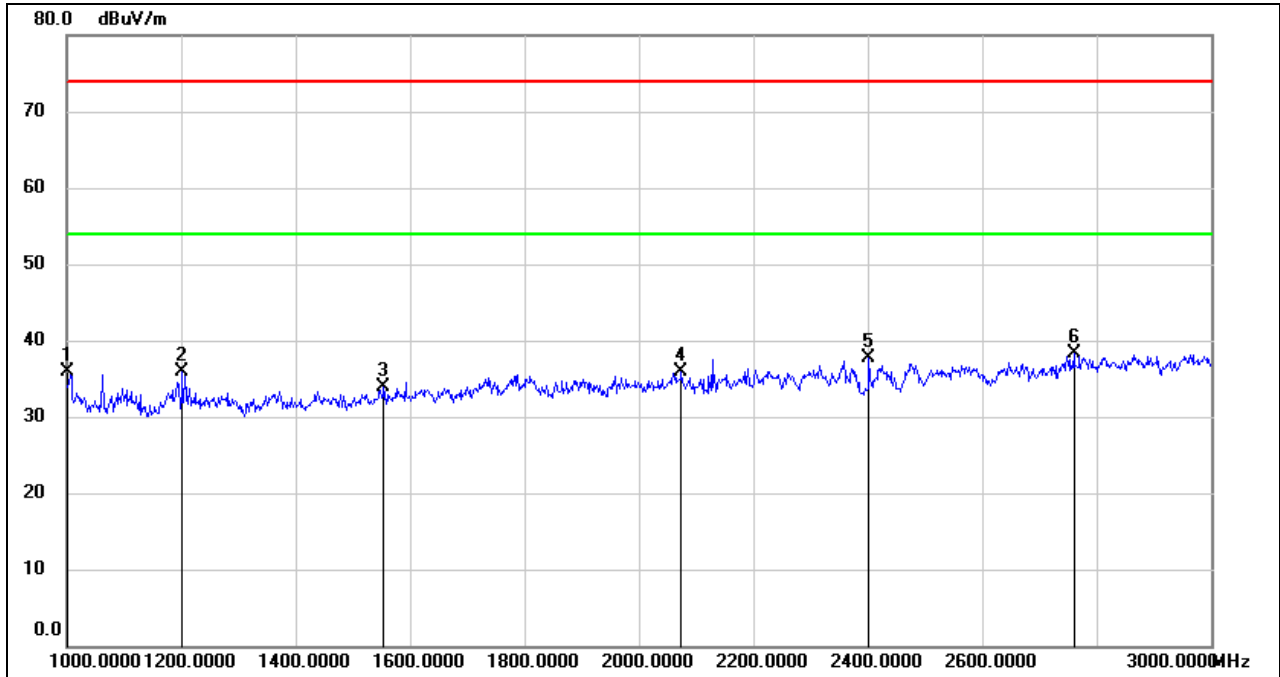

No.	Frequency (MHz)	Reading (dBuV)	Correct (dB/m)	Result (dBuV/m)	Limit (dBuV/m)	Margin (dB)	Remark
1	1000.0000	49.73	-13.85	35.88	74.00	-38.12	peak
2	1202.000	48.77	-12.92	35.85	74.00	-38.15	peak
3	1554.000	45.89	-11.99	33.90	74.00	-40.10	peak
4	2074.000	45.42	-9.50	35.92	74.00	-38.08	peak
5	2402.000	45.66	-7.95	37.71	/	/	fundamental
6	2760.000	44.78	-6.51	38.27	74.00	-35.73	peak

- Note: 1. Measurement = Reading Level + Correct Factor.  
 2. If Peak Result complies with AV limit, AV Result is deemed to comply with AV limit.  
 3. Peak: Peak detector.  
 4. Filter losses were only considered in the spurious frequency bands and the authorized band was not corrected for Band Reject Filter loss.  
 5. Proper operation of the transmitter prior to adding the filter to the measurement chain.  
 6. The testing was completed with the band reject fitter, for the fundamental emission please refer to the bandedge test result.



**HARMONICS AND SPURIOUS EMISSIONS (LOW CHANNEL, VERTICAL)**

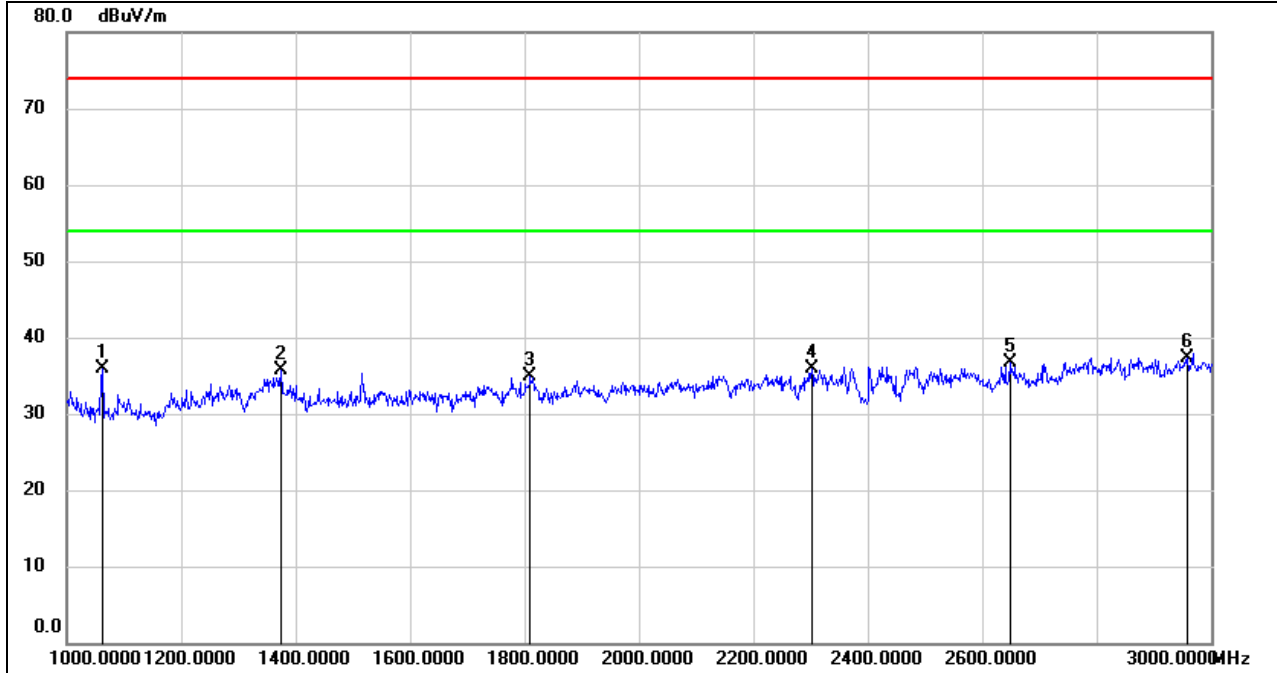

No.	Frequency (MHz)	Reading (dBuV)	Correct (dB/m)	Result (dBuV/m)	Limit (dBuV/m)	Margin (dB)	Remark
1	1062.000	49.76	-13.81	35.95	74.00	-38.05	peak
2	1374.000	48.23	-12.61	35.62	74.00	-38.38	peak
3	1810.000	44.93	-10.11	34.82	74.00	-39.18	peak
4	2302.000	44.21	-8.31	35.90	74.00	-38.10	peak
5	2648.000	44.12	-7.48	36.64	74.00	-37.36	peak
6	2958.000	42.72	-5.38	37.34	74.00	-36.66	peak

Note: 1. Measurement = Reading Level + Correct Factor.  
 2. If Peak Result complies with AV limit, AV Result is deemed to comply with AV limit.  
 3. Peak: Peak detector.  
 4. Filter losses were only considered in the spurious frequency bands and the authorized band was not corrected for Band Reject Filter loss.  
 5. Proper operation of the transmitter prior to adding the filter to the measurement chain.  
 6. The testing was completed with the band reject filter, for the fundamental emission please refer to the bandedge test result.



**HARMONICS AND SPURIOUS EMISSIONS (MID CHANNEL, HORIZONTAL)**

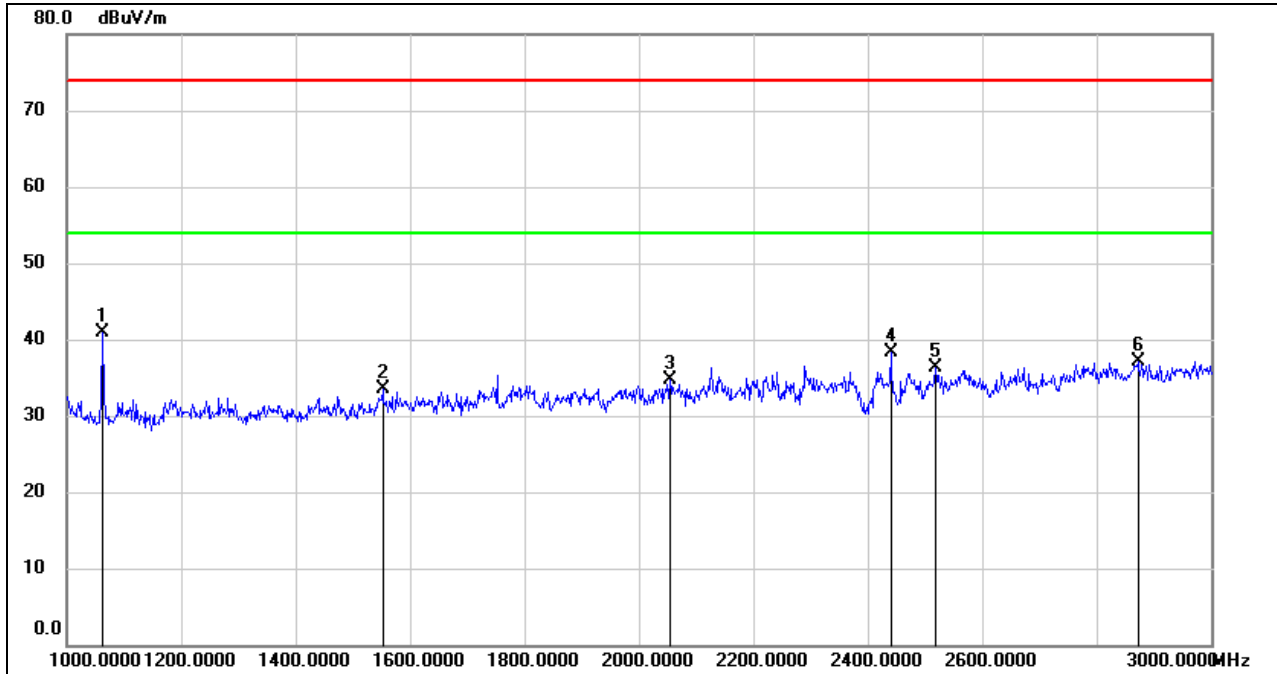

No.	Frequency (MHz)	Reading (dBuV)	Correct (dB/m)	Result (dBuV/m)	Limit (dBuV/m)	Margin (dB)	Remark
1	1062.000	54.72	-13.81	40.91	74.00	-33.09	peak
2	1552.000	45.58	-12.01	33.57	74.00	-40.43	peak
3	2054.000	44.32	-9.63	34.69	74.00	-39.31	peak
4	2440.000	45.98	-7.68	38.30	/	/	fundamental
5	2518.000	43.66	-7.34	36.32	74.00	-37.68	peak
6	2872.000	42.74	-5.67	37.07	74.00	-36.93	peak

Note: 1. Measurement = Reading Level + Correct Factor.  
 2. If Peak Result complies with AV limit, AV Result is deemed to comply with AV limit.  
 3. Peak: Peak detector.  
 4. Filter losses were only considered in the spurious frequency bands and the authorized band was not corrected for Band Reject Filter loss.  
 5. Proper operation of the transmitter prior to adding the filter to the measurement chain.  
 6. The testing was completed with the band reject filter, for the fundamental emission please refer to the bandedge test result.



**HARMONICS AND SPURIOUS EMISSIONS (MID CHANNEL, VERTICAL)**

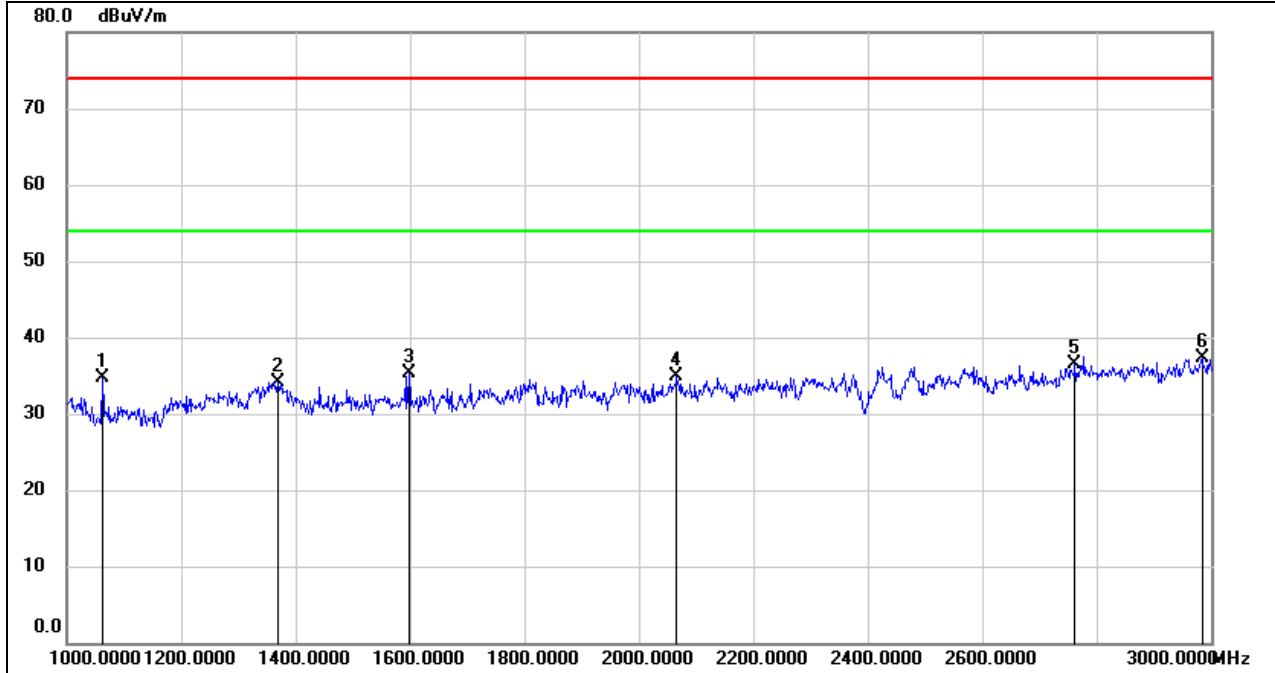

No.	Frequency (MHz)	Reading (dBuV)	Correct (dB/m)	Result (dBuV/m)	Limit (dBuV/m)	Margin (dB)	Remark
1	1062.000	48.57	-13.81	34.76	74.00	-39.24	peak
2	1368.000	46.79	-12.61	34.18	74.00	-39.82	peak
3	1598.000	46.90	-11.63	35.27	74.00	-38.73	peak
4	2066.000	44.48	-9.55	34.93	74.00	-39.07	peak
5	2762.000	42.92	-6.49	36.43	74.00	-37.57	peak
6	2984.000	42.57	-5.32	37.25	74.00	-36.75	peak

Note: 1. Measurement = Reading Level + Correct Factor.  
 2. If Peak Result complies with AV limit, AV Result is deemed to comply with AV limit.  
 3. Peak: Peak detector.  
 4. Filter losses were only considered in the spurious frequency bands and the authorized band was not corrected for Band Reject Filter loss.  
 5. Proper operation of the transmitter prior to adding the filter to the measurement chain.  
 6. The testing was completed with the band reject fitter, for the fundamental emission please refer to the bandedge test result.



**HARMONICS AND SPURIOUS EMISSIONS (HIGH CHANNEL, HORIZONTAL)**

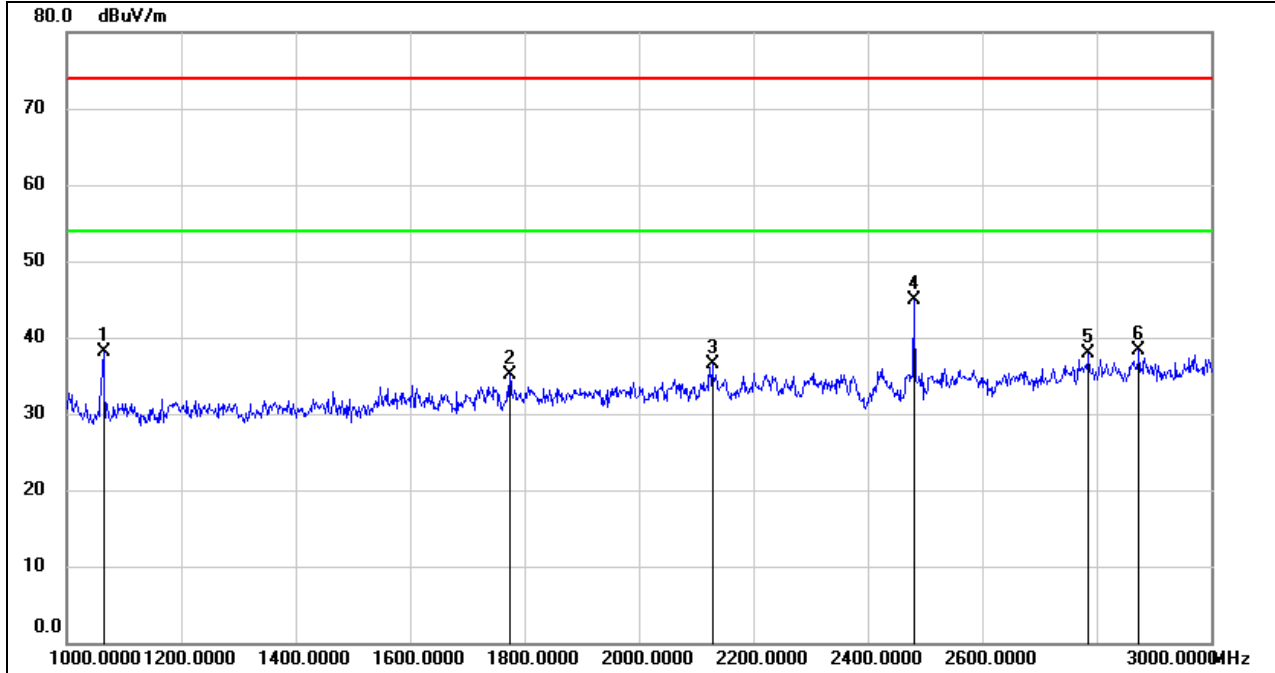

No.	Frequency (MHz)	Reading (dBuV)	Correct (dB/m)	Result (dBuV/m)	Limit (dBuV/m)	Margin (dB)	Remark
1	1064.000	51.86	-13.80	38.06	74.00	-35.94	peak
2	1774.000	45.42	-10.37	35.05	74.00	-38.95	peak
3	2128.000	45.67	-9.18	36.49	74.00	-37.51	peak
4	2480.000	52.32	-7.39	44.93	/	/	fundamental
5	2786.000	44.09	-6.23	37.86	74.00	-36.14	peak
6	2874.000	43.92	-5.66	38.26	74.00	-35.74	peak

- Note: 1. Measurement = Reading Level + Correct Factor.  
 2. If Peak Result complies with AV limit, AV Result is deemed to comply with AV limit.  
 3. Peak: Peak detector.  
 4. Filter losses were only considered in the spurious frequency bands and the authorized band was not corrected for Band Reject Filter loss.  
 5. Proper operation of the transmitter prior to adding the filter to the measurement chain.  
 6. The testing was completed with the band reject filter, for the fundamental emission please refer to the bandedged test result.



**HARMONICS AND SPURIOUS EMISSIONS (HIGH CHANNEL, VERTICAL)**

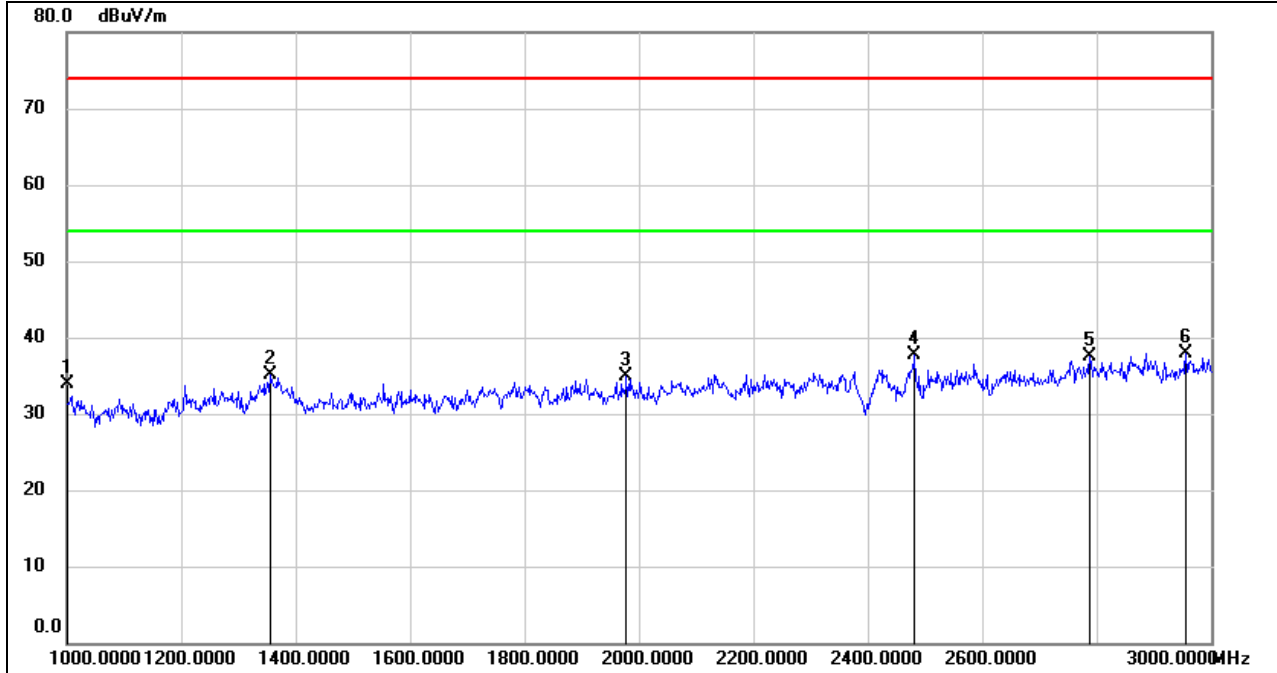

No.	Frequency (MHz)	Reading (dBuV)	Correct (dB/m)	Result (dBuV/m)	Limit (dBuV/m)	Margin (dB)	Remark
1	1000.0000	47.77	-13.85	33.92	74.00	-40.08	peak
2	1356.000	47.71	-12.60	35.11	74.00	-38.89	peak
3	1978.000	44.90	-10.03	34.87	74.00	-39.13	peak
4	2480.000	45.08	-7.37	37.71	/	/	fundamental
5	2788.000	43.68	-6.20	37.48	74.00	-36.52	peak
6	2956.000	43.39	-5.39	38.00	74.00	-36.00	peak

- Note: 1. Measurement = Reading Level + Correct Factor.  
 2. If Peak Result complies with AV limit, AV Result is deemed to comply with AV limit.  
 3. Peak: Peak detector.  
 4. Filter losses were only considered in the spurious frequency bands and the authorized band was not corrected for Band Reject Filter loss.  
 5. Proper operation of the transmitter prior to adding the filter to the measurement chain.  
 6. The testing was completed with the band reject filter, for the fundamental emission please refer to the bandedged test result.





### 8.2.2. GFSK(2Mbps) MODE

#### HARMONICS AND SPURIOUS EMISSIONS (LOW CHANNEL, HORIZONTAL)

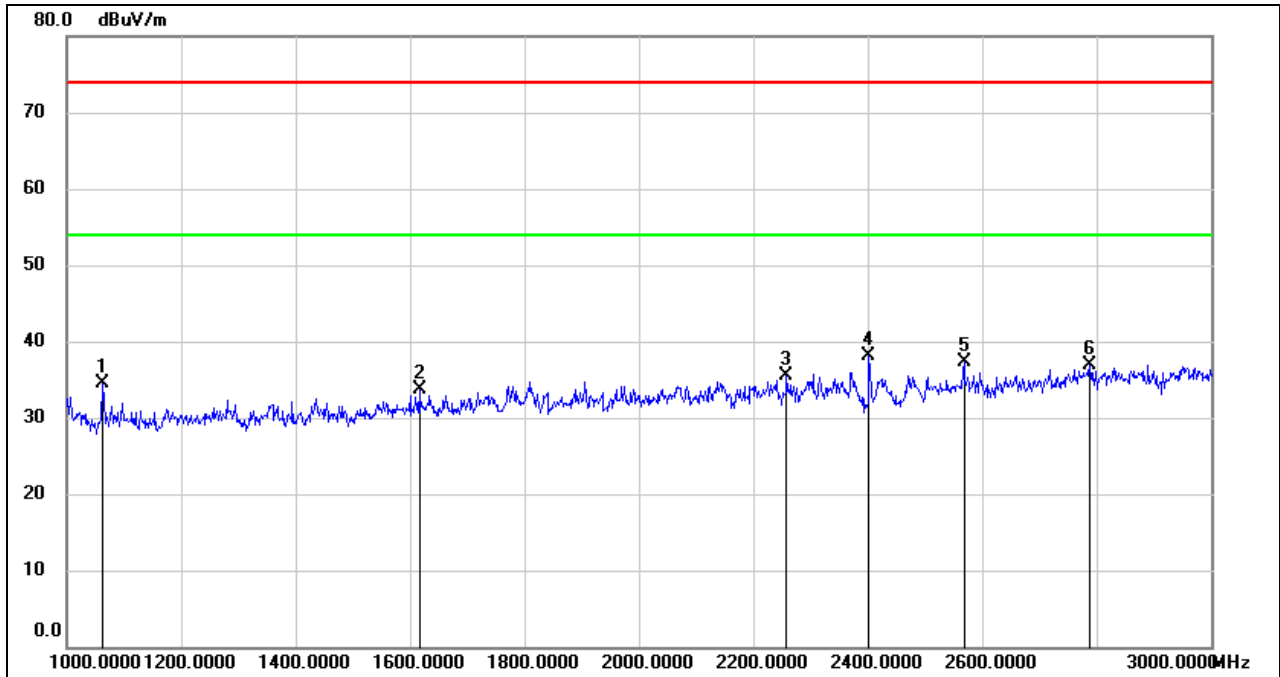

No.	Frequency (MHz)	Reading (dBuV)	Correct (dB/m)	Result (dBuV/m)	Limit (dBuV/m)	Margin (dB)	Remark
1	1062.000	48.34	-13.81	34.53	74.00	-39.47	peak
2	1616.000	45.20	-11.53	33.67	74.00	-40.33	peak
3	2258.000	44.08	-8.52	35.56	74.00	-38.44	peak
4	2402.000	46.02	-7.95	38.07	/	/	fundamental
5	2568.000	44.95	-7.61	37.34	74.00	-36.66	peak
6	2788.000	43.06	-6.20	36.86	74.00	-37.14	peak

- Note: 1. Measurement = Reading Level + Correct Factor.  
 2. If Peak Result complies with AV limit, AV Result is deemed to comply with AV limit.  
 3. Peak: Peak detector.  
 4. Filter losses were only considered in the spurious frequency bands and the authorized band was not corrected for Band Reject Filter loss.  
 5. Proper operation of the transmitter prior to adding the filter to the measurement chain.  
 6. The testing was completed with the band reject fitter, for the fundamental emission please refer to the bandedge test result.



**HARMONICS AND SPURIOUS EMISSIONS (LOW CHANNEL, VERTICAL)**

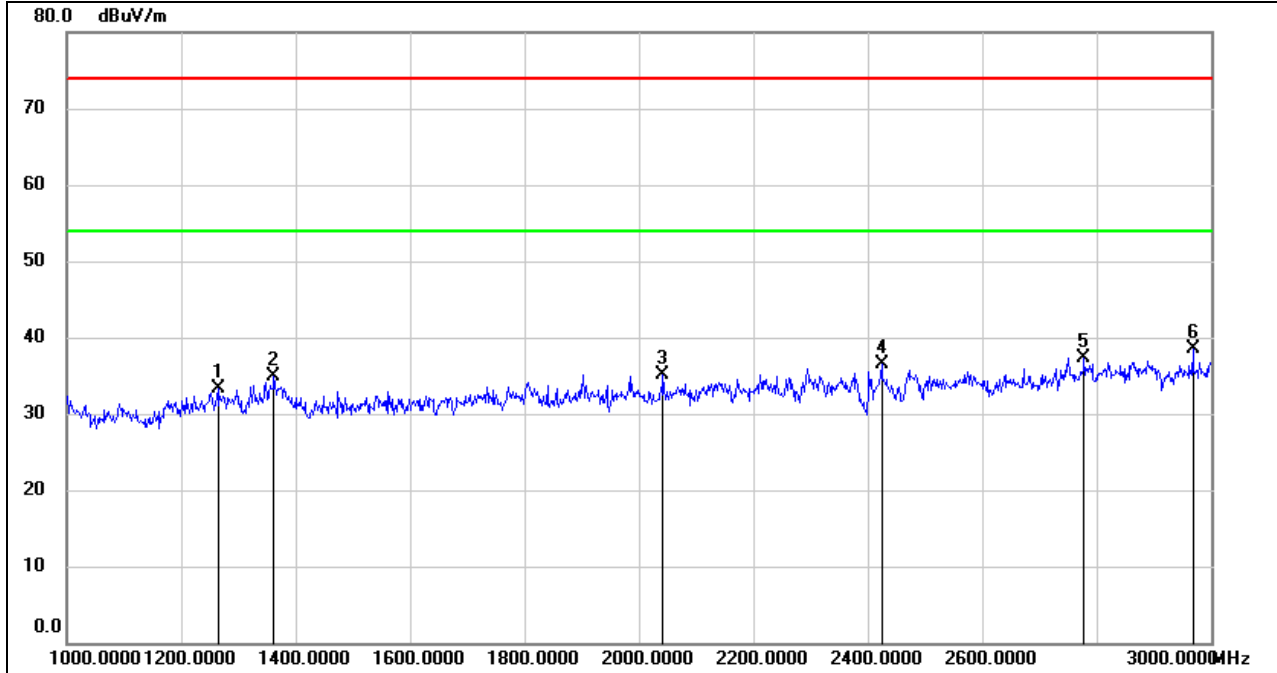

No.	Frequency (MHz)	Reading (dBuV)	Correct (dB/m)	Result (dBuV/m)	Limit (dBuV/m)	Margin (dB)	Remark
1	1264.000	46.06	-12.70	33.36	74.00	-40.64	peak
2	1362.000	47.54	-12.60	34.94	74.00	-39.06	peak
3	2042.000	44.86	-9.71	35.15	74.00	-38.85	peak
4	2424.000	44.22	-7.79	36.43	74.00	-37.57	peak
5	2778.000	43.64	-6.32	37.32	74.00	-36.68	peak
6	2968.000	43.87	-5.36	38.51	74.00	-35.49	peak

Note: 1. Measurement = Reading Level + Correct Factor.  
 2. If Peak Result complies with AV limit, AV Result is deemed to comply with AV limit.  
 3. Peak: Peak detector.  
 4. Filter losses were only considered in the spurious frequency bands and the authorized band was not corrected for Band Reject Filter loss.  
 5. Proper operation of the transmitter prior to adding the filter to the measurement chain.  
 6. The testing was completed with the band reject filter, for the fundamental emission please refer to the bandedge test result.



**HARMONICS AND SPURIOUS EMISSIONS (MID CHANNEL, HORIZONTAL)**

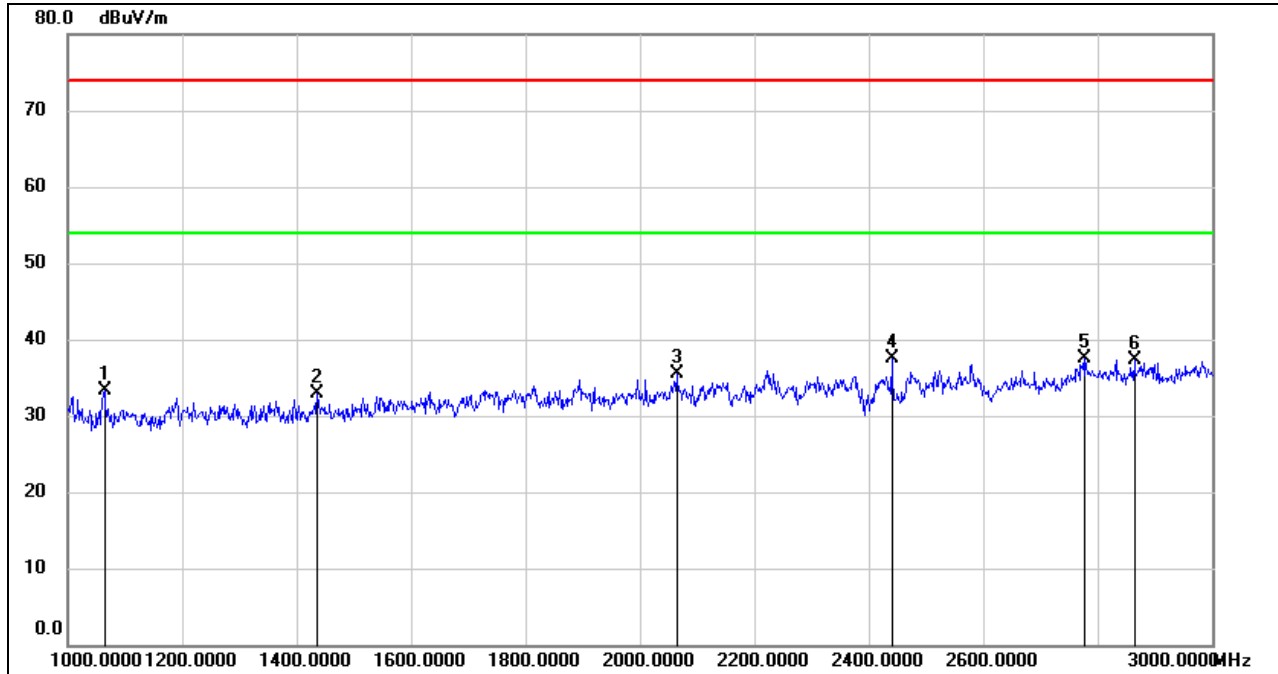

No.	Frequency (MHz)	Reading (dBuV)	Correct (dB/m)	Result (dBuV/m)	Limit (dBuV/m)	Margin (dB)	Remark
1	1064.000	47.17	-13.80	33.37	74.00	-40.63	peak
2	1436.000	45.36	-12.55	32.81	74.00	-41.19	peak
3	2064.000	45.04	-9.55	35.49	74.00	-38.51	peak
4	2440.000	45.24	-7.68	37.56	/	/	fundamental
5	2778.000	43.82	-6.32	37.50	74.00	-36.50	peak
6	2864.000	43.08	-5.72	37.36	74.00	-36.64	peak

Note: 1. Measurement = Reading Level + Correct Factor.  
 2. If Peak Result complies with AV limit, AV Result is deemed to comply with AV limit.  
 3. Peak: Peak detector.  
 4. Filter losses were only considered in the spurious frequency bands and the authorized band was not corrected for Band Reject Filter loss.  
 5. Proper operation of the transmitter prior to adding the filter to the measurement chain.  
 6. The testing was completed with the band reject filter, for the fundamental emission please refer to the bandedged test result.



**HARMONICS AND SPURIOUS EMISSIONS (MID CHANNEL, VERTICAL)**

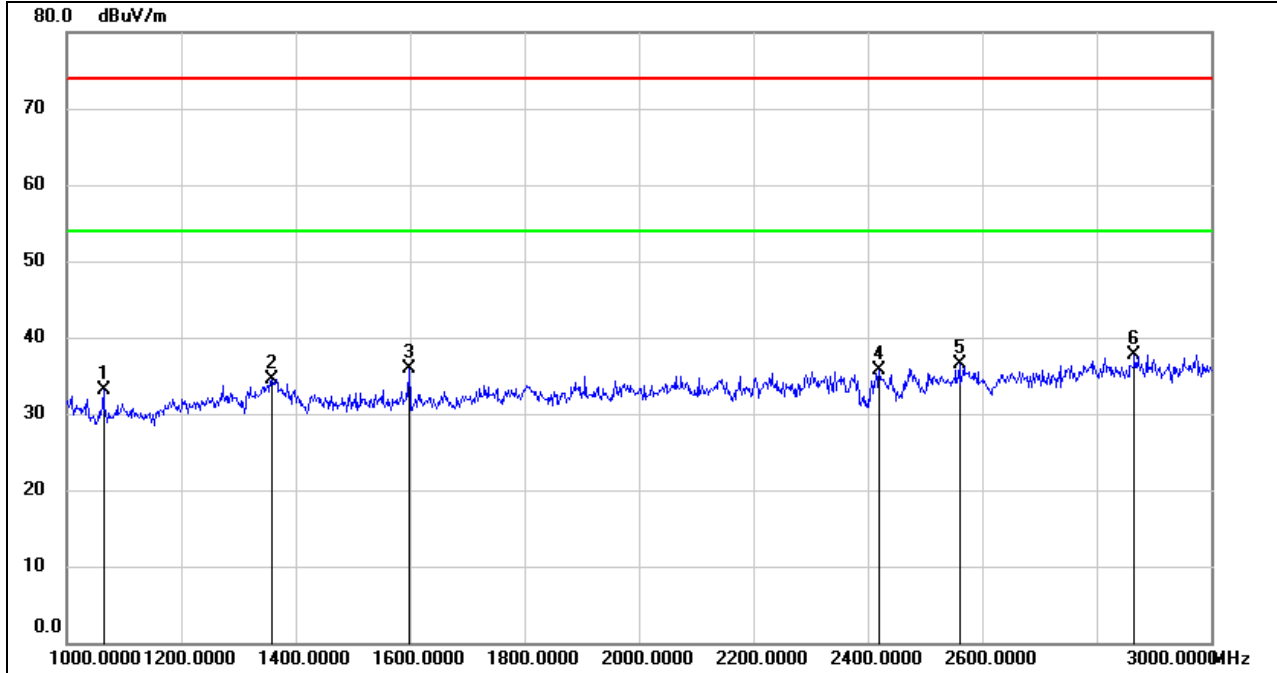

No.	Frequency (MHz)	Reading (dBuV)	Correct (dB/m)	Result (dBuV/m)	Limit (dBuV/m)	Margin (dB)	Remark
1	1064.000	46.89	-13.80	33.09	74.00	-40.91	peak
2	1358.000	47.10	-12.61	34.49	74.00	-39.51	peak
3	1598.000	47.45	-11.63	35.82	74.00	-38.18	peak
4	2420.000	43.51	-7.81	35.70	74.00	-38.30	peak
5	2560.000	44.10	-7.55	36.55	74.00	-37.45	peak
6	2866.000	43.51	-5.71	37.80	74.00	-36.20	peak

Note: 1. Measurement = Reading Level + Correct Factor.  
 2. If Peak Result complies with AV limit, AV Result is deemed to comply with AV limit.  
 3. Peak: Peak detector.  
 4. Filter losses were only considered in the spurious frequency bands and the authorized band was not corrected for Band Reject Filter loss.  
 5. Proper operation of the transmitter prior to adding the filter to the measurement chain.  
 6. The testing was completed with the band reject fitter, for the fundamental emission please refer to the bandedge test result.



**HARMONICS AND SPURIOUS EMISSIONS (HIGH CHANNEL, HORIZONTAL)**

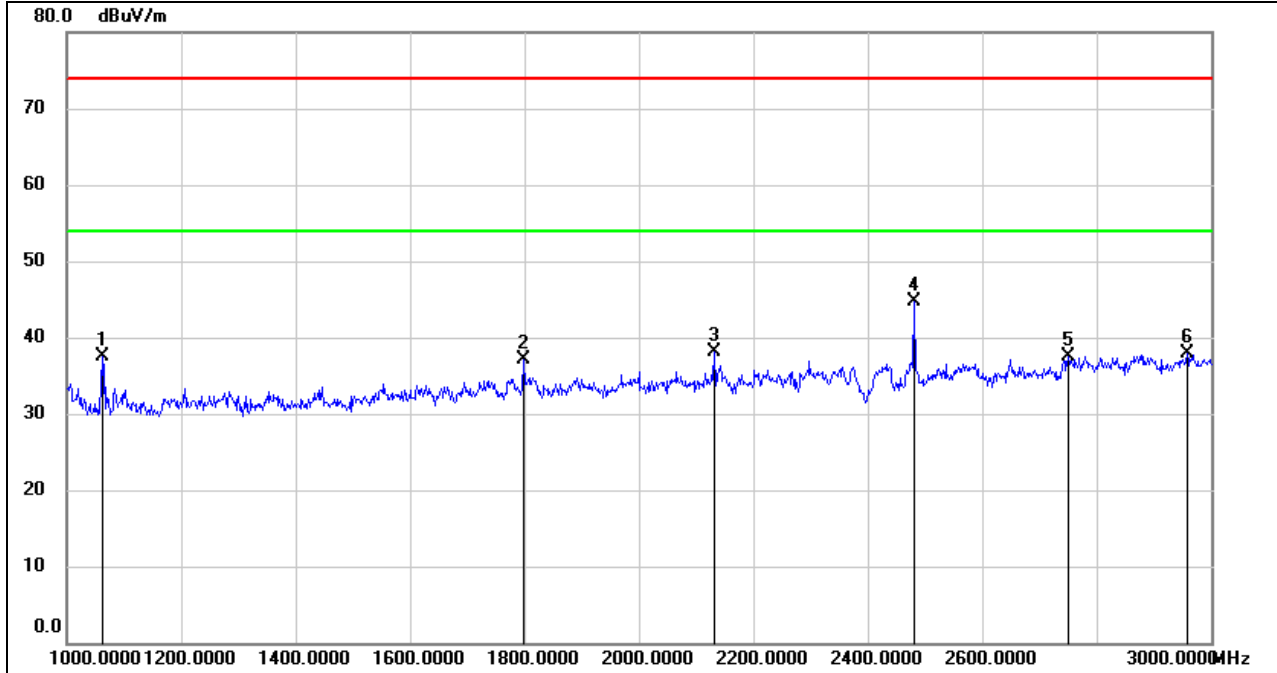

No.	Frequency (MHz)	Reading (dBuV)	Correct (dB/m)	Result (dBuV/m)	Limit (dBuV/m)	Margin (dB)	Remark
1	1062.000	51.33	-13.81	37.52	74.00	-36.48	peak
2	1798.000	47.15	-10.13	37.02	74.00	-36.98	peak
3	2132.000	47.22	-9.15	38.07	74.00	-35.93	peak
4	2480.000	52.03	-7.39	44.64	/	/	fundamental
5	2750.000	44.18	-6.62	37.56	74.00	-36.44	peak
6	2958.000	43.19	-5.38	37.81	74.00	-36.19	peak

Note: 1. Measurement = Reading Level + Correct Factor.  
 2. If Peak Result complies with AV limit, AV Result is deemed to comply with AV limit.  
 3. Peak: Peak detector.  
 4. Filter losses were only considered in the spurious frequency bands and the authorized band was not corrected for Band Reject Filter loss.  
 5. Proper operation of the transmitter prior to adding the filter to the measurement chain.  
 6. The testing was completed with the band reject filter, for the fundamental emission please refer to the bandedge test result.



**HARMONICS AND SPURIOUS EMISSIONS (HIGH CHANNEL, VERTICAL)**

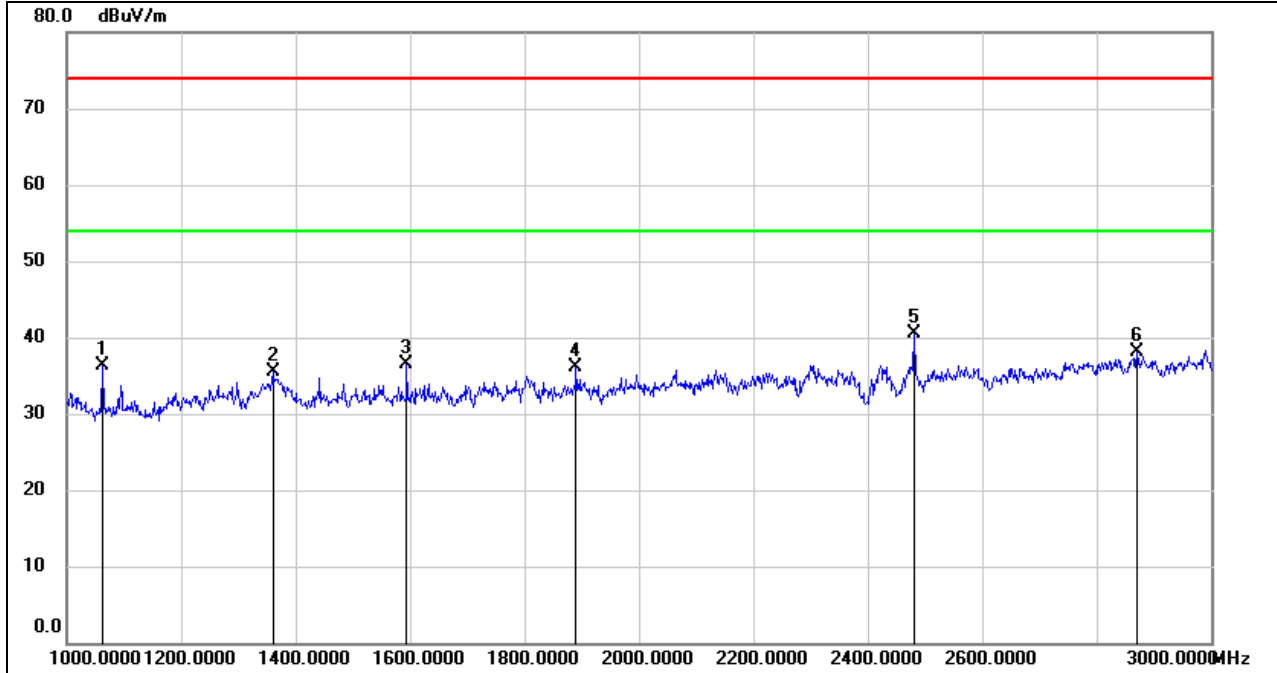

No.	Frequency (MHz)	Reading (dBuV)	Correct (dB/m)	Result (dBuV/m)	Limit (dBuV/m)	Margin (dB)	Remark
1	1062.000	50.14	-13.81	36.33	74.00	-37.67	peak
2	1360.000	48.02	-12.60	35.42	74.00	-38.58	peak
3	1594.000	48.18	-11.66	36.52	74.00	-37.48	peak
4	1890.000	46.17	-10.14	36.03	74.00	-37.97	peak
5	2480.000	47.86	-7.39	40.47	/	/	fundamental
6	2870.000	43.79	-5.69	38.10	74.00	-35.90	peak

Note: 1. Measurement = Reading Level + Correct Factor.  
 2. If Peak Result complies with AV limit, AV Result is deemed to comply with AV limit.  
 3. Peak: Peak detector.  
 4. Filter losses were only considered in the spurious frequency bands and the authorized band was not corrected for Band Reject Filter loss.  
 5. Proper operation of the transmitter prior to adding the filter to the measurement chain.  
 6. The testing was completed with the band reject fitter, for the fundamental emission please refer to the bandedge test result.



### 8.3. SPURIOUS EMISSIONS (3~18GHz)

#### 8.3.1. GFSK(1Mbps) MODE

##### HARMONICS AND SPURIOUS EMISSIONS (LOW CHANNEL, HORIZONTAL)

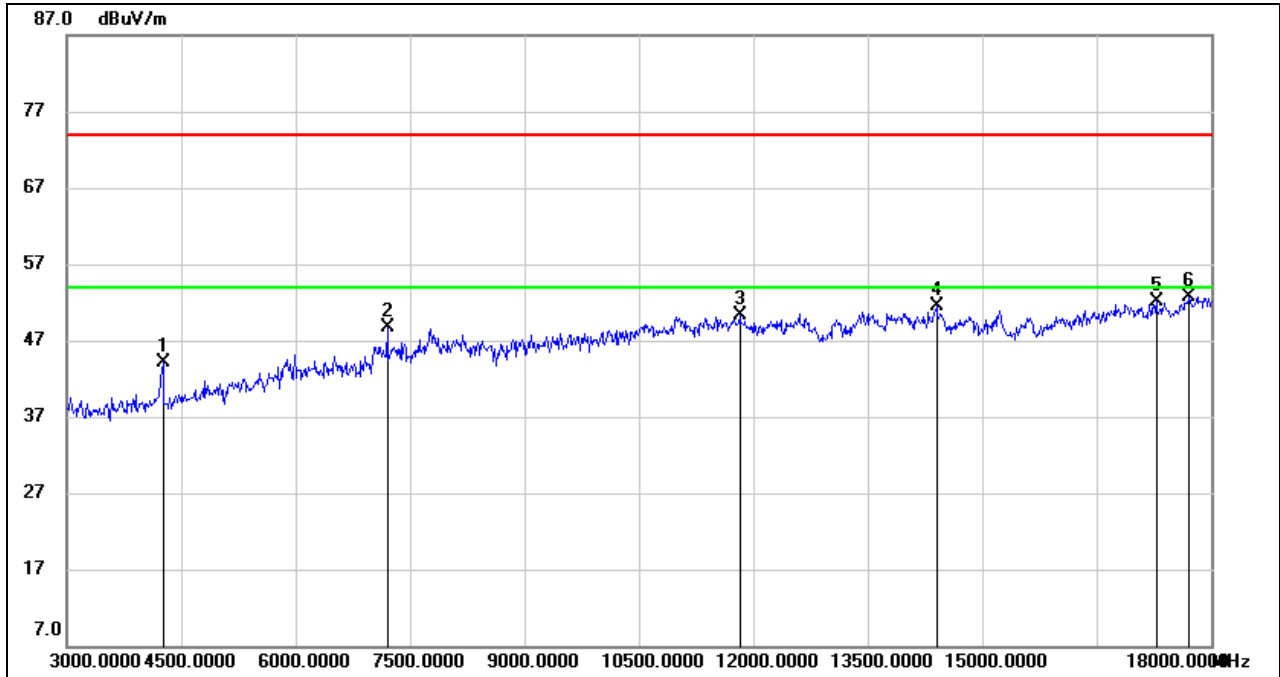

No.	Frequency (MHz)	Reading (dBuV)	Correct (dB/m)	Result (dBuV/m)	Limit (dBuV/m)	Margin (dB)	Remark
1	4260.000	45.95	-1.84	44.11	74.00	-29.89	peak
2	7200.000	41.59	7.05	48.64	74.00	-25.36	peak
3	11820.000	35.90	14.31	50.21	74.00	-23.79	peak
4	14400.000	34.89	16.68	51.57	74.00	-22.43	peak
5	17280.000	30.31	21.89	52.20	74.00	-21.80	peak
6	17715.000	30.12	22.65	52.77	74.00	-21.23	peak

- Note: 1. Peak Result = Reading Level + Correct Factor.  
 2. If Peak Result complies with AV limit, AV Result is deemed to comply with AV limit.  
 3. Peak: Peak detector.  
 4. Filter losses were only considered in the spurious frequency bands and the authorized band was not corrected for HPF losses.  
 5. Proper operation of the transmitter prior to adding the filter to the measurement chain.



**HARMONICS AND SPURIOUS EMISSIONS (LOW CHANNEL, VERTICAL)**

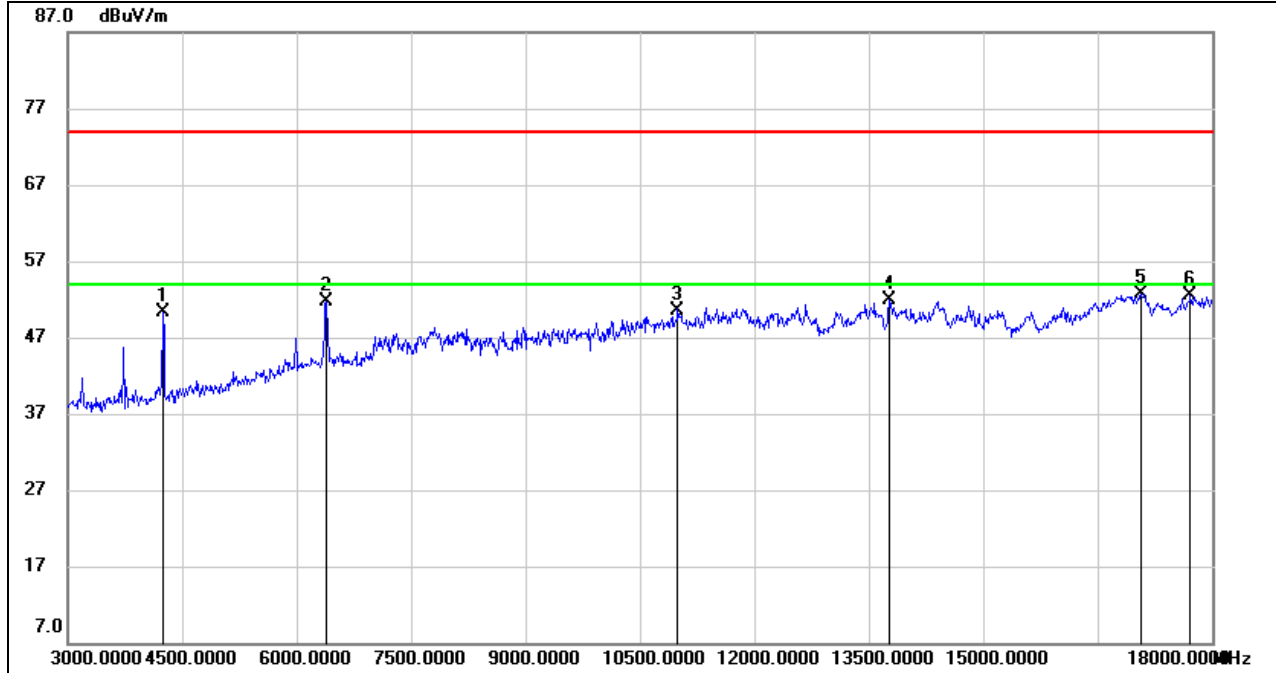

No.	Frequency (MHz)	Reading (dBuV)	Correct (dB/m)	Result (dBuV/m)	Limit (dBuV/m)	Margin (dB)	Remark
1	4245.000	51.93	-1.71	50.22	74.00	-23.78	peak
2	6390.000	46.46	5.15	51.61	74.00	-22.39	peak
3	10995.000	36.98	13.62	50.60	74.00	-23.40	peak
4	13770.000	34.76	17.20	51.96	74.00	-22.04	peak
5	17070.000	31.68	20.99	52.67	74.00	-21.33	peak
6	17715.000	29.90	22.65	52.55	74.00	-21.45	peak

- Note: 1. Peak Result = Reading Level + Correct Factor.  
 2. If Peak Result complies with AV limit, AV Result is deemed to comply with AV limit.  
 3. Peak: Peak detector.  
 4. Filter losses were only considered in the spurious frequency bands and the authorized band was not corrected for HPF losses.  
 5. Proper operation of the transmitter prior to adding the filter to the measurement chain.





**HARMONICS AND SPURIOUS EMISSIONS (MID CHANNEL, HORIZONTAL)**

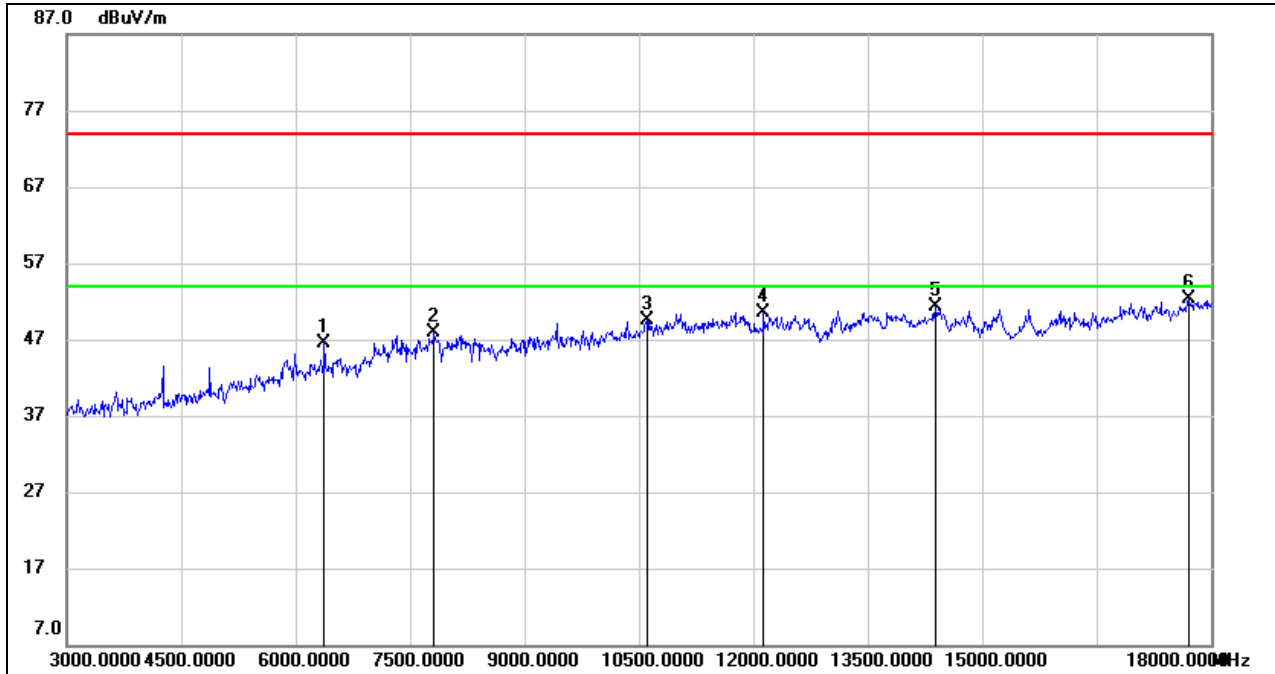

No.	Frequency (MHz)	Reading (dBuV)	Correct (dB/m)	Result (dBuV/m)	Limit (dBuV/m)	Margin (dB)	Remark
1	6375.000	41.52	5.08	46.60	74.00	-27.40	peak
2	7815.000	38.54	9.31	47.85	74.00	-26.15	peak
3	10605.000	36.71	12.88	49.59	74.00	-24.41	peak
4	12135.000	35.68	14.82	50.50	74.00	-23.50	peak
5	14385.000	34.65	16.67	51.32	74.00	-22.68	peak
6	17715.000	29.70	22.65	52.35	74.00	-21.65	peak

- Note: 1. Peak Result = Reading Level + Correct Factor.  
 2. If Peak Result complies with AV limit, AV Result is deemed to comply with AV limit.  
 3. Peak: Peak detector.  
 4. Filter losses were only considered in the spurious frequency bands and the authorized band was not corrected for HPF losses.  
 5. Proper operation of the transmitter prior to adding the filter to the measurement chain.



**HARMONICS AND SPURIOUS EMISSIONS (MID CHANNEL, VERTICAL)**

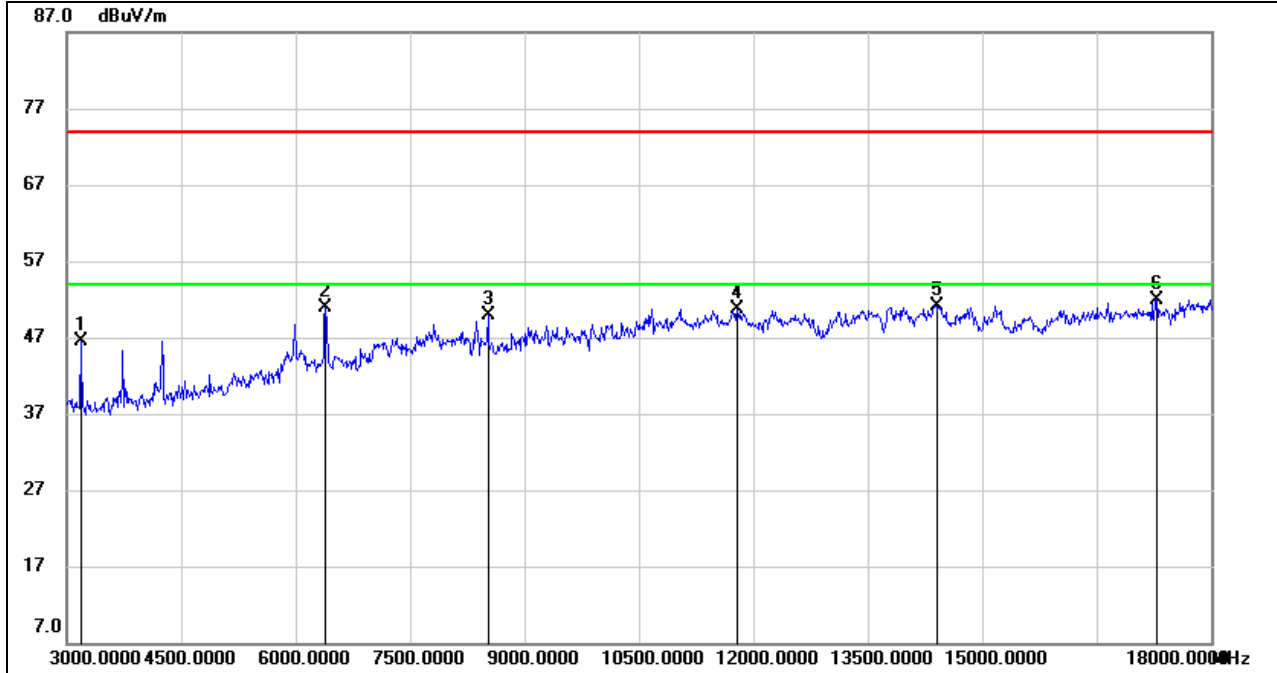

No.	Frequency (MHz)	Reading (dBuV)	Correct (dB/m)	Result (dBuV/m)	Limit (dBuV/m)	Margin (dB)	Remark
1	3180.000	50.77	-4.30	46.47	74.00	-27.53	peak
2	6390.000	45.72	5.15	50.87	74.00	-23.13	peak
3	8520.000	41.09	8.76	49.85	74.00	-24.15	peak
4	11790.000	36.45	14.28	50.73	74.00	-23.27	peak
5	14400.000	34.47	16.68	51.15	74.00	-22.85	peak
6	17295.000	29.94	22.01	51.95	74.00	-22.05	peak

- Note: 1. Peak Result = Reading Level + Correct Factor.  
 2. If Peak Result complies with AV limit, AV Result is deemed to comply with AV limit.  
 3. Peak: Peak detector.  
 4. Filter losses were only considered in the spurious frequency bands and the authorized band was not corrected for HPF losses.  
 5. Proper operation of the transmitter prior to adding the filter to the measurement chain.



**HARMONICS AND SPURIOUS EMISSIONS (HIGH CHANNEL, HORIZONTAL)**

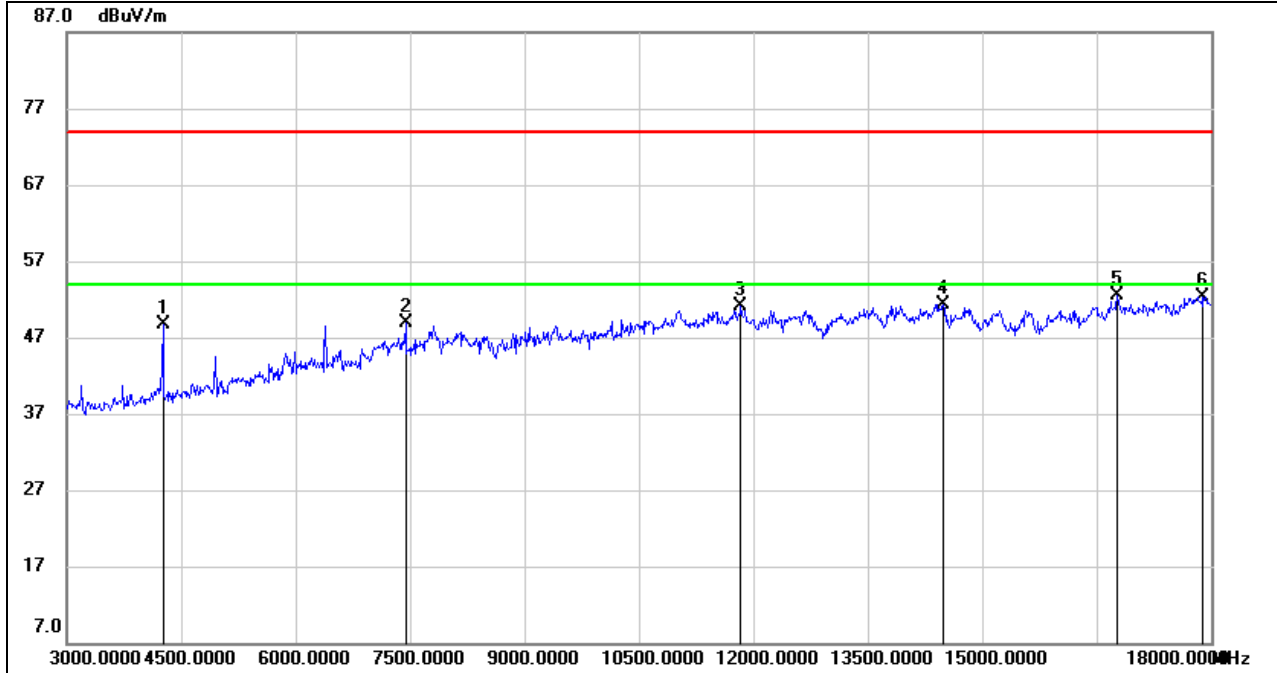

No.	Frequency (MHz)	Reading (dBuV)	Correct (dB/m)	Result (dBuV/m)	Limit (dBuV/m)	Margin (dB)	Remark
1	4260.000	50.53	-1.84	48.69	74.00	-25.31	peak
2	7440.000	41.17	7.65	48.82	74.00	-25.18	peak
3	11835.000	36.82	14.33	51.15	74.00	-22.85	peak
4	14490.000	34.67	16.64	51.31	74.00	-22.69	peak
5	16770.000	32.24	20.28	52.52	74.00	-21.48	peak
6	17895.000	29.03	23.33	52.36	74.00	-21.64	peak

- Note: 1. Peak Result = Reading Level + Correct Factor.  
 2. If Peak Result complies with AV limit, AV Result is deemed to comply with AV limit.  
 3. Peak: Peak detector.  
 4. Filter losses were only considered in the spurious frequency bands and the authorized band was not corrected for HPF losses.  
 5. Proper operation of the transmitter prior to adding the filter to the measurement chain.



**HARMONICS AND SPURIOUS EMISSIONS (HIGH CHANNEL, VERTICAL)**

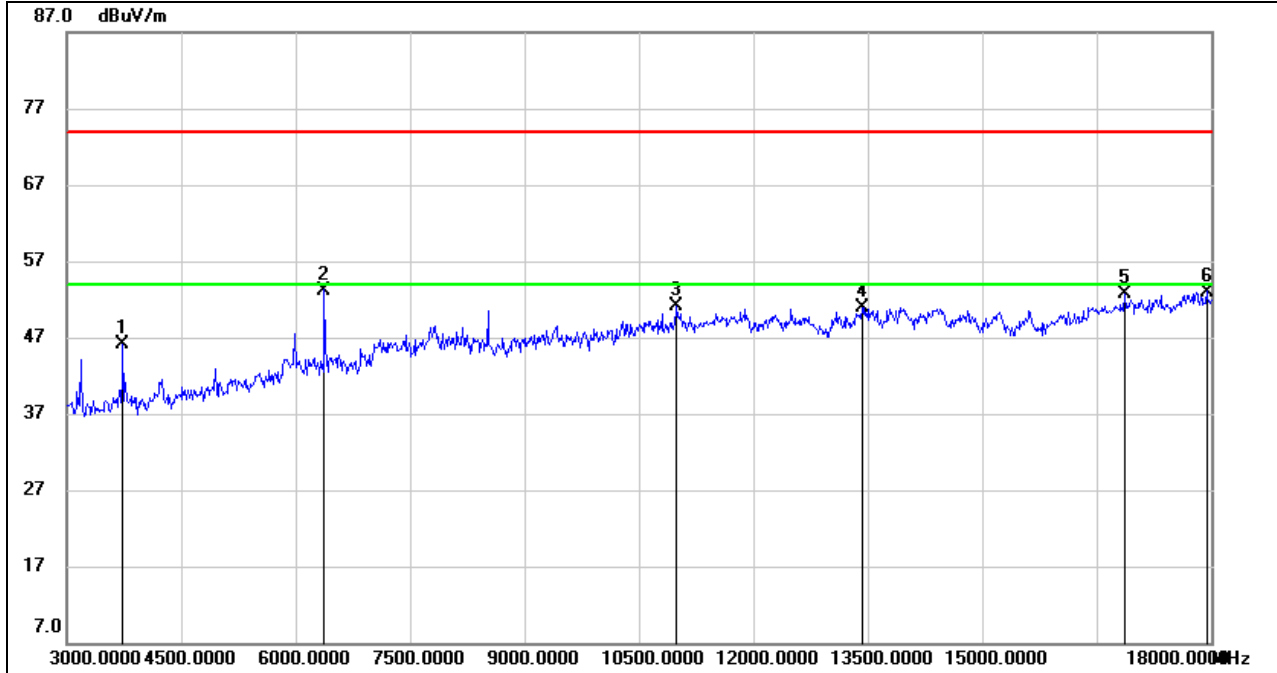

No.	Frequency (MHz)	Reading (dBuV)	Correct (dB/m)	Result (dBuV/m)	Limit (dBuV/m)	Margin (dB)	Remark
1	3735.000	48.77	-2.67	46.10	74.00	-27.90	peak
2	6375.000	48.12	5.08	53.20	74.00	-20.80	peak
3	10995.000	37.41	13.62	51.03	74.00	-22.97	peak
4	13425.000	34.61	16.31	50.92	74.00	-23.08	peak
5	16860.000	32.29	20.33	52.62	74.00	-21.38	peak
6	17940.000	29.63	23.37	53.00	74.00	-21.00	peak

- Note: 1. Peak Result = Reading Level + Correct Factor.  
 2. If Peak Result complies with AV limit, AV Result is deemed to comply with AV limit.  
 3. Peak: Peak detector.  
 4. Filter losses were only considered in the spurious frequency bands and the authorized band was not corrected for HPF losses.  
 5. Proper operation of the transmitter prior to adding the filter to the measurement chain.



### 8.3.2. GFSK(2Mbps) MODE

#### HARMONICS AND SPURIOUS EMISSIONS (LOW CHANNEL, HORIZONTAL)

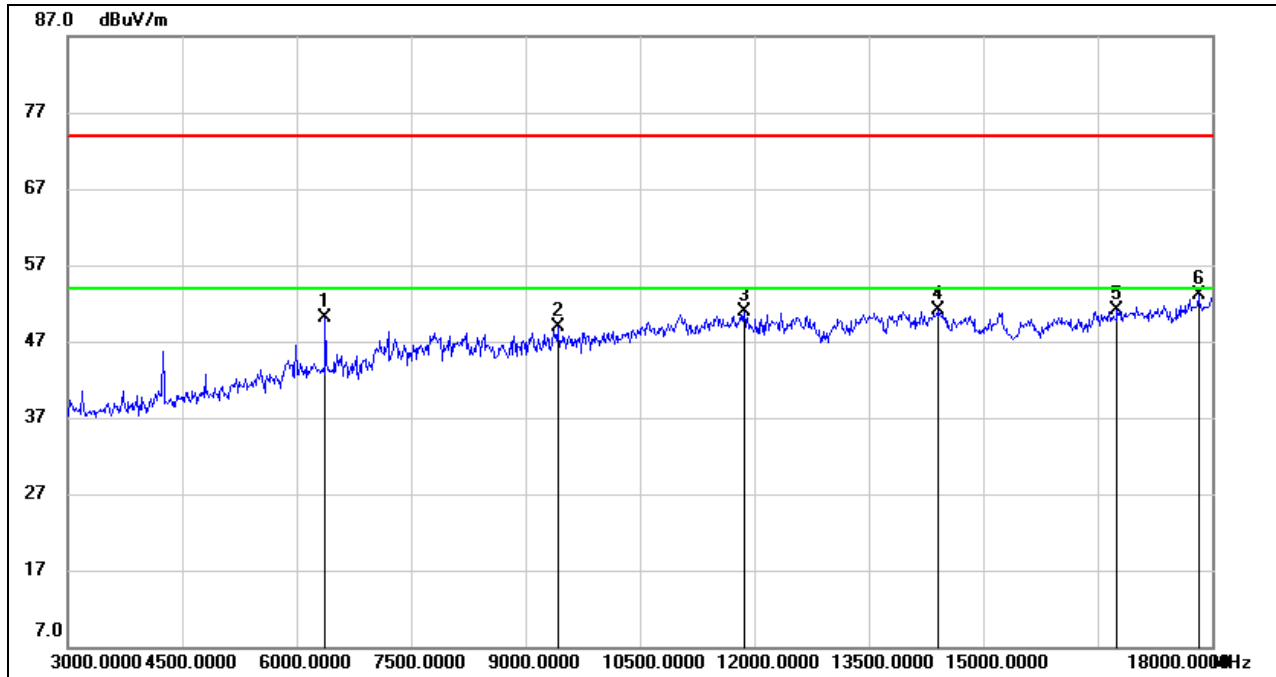

No.	Frequency (MHz)	Reading (dBuV)	Correct (dB/m)	Result (dBuV/m)	Limit (dBuV/m)	Margin (dB)	Remark
1	6375.000	45.09	5.08	50.17	74.00	-23.83	peak
2	9420.000	38.30	10.61	48.91	74.00	-25.09	peak
3	11865.000	36.50	14.33	50.83	74.00	-23.17	peak
4	14400.000	34.48	16.68	51.16	74.00	-22.84	peak
5	16755.000	30.89	20.26	51.15	74.00	-22.85	peak
6	17820.000	29.68	23.34	53.02	74.00	-20.98	peak

- Note: 1. Peak Result = Reading Level + Correct Factor.  
 2. If Peak Result complies with AV limit, AV Result is deemed to comply with AV limit.  
 3. Peak: Peak detector.  
 4. Filter losses were only considered in the spurious frequency bands and the authorized band was not corrected for HPF losses.  
 5. Proper operation of the transmitter prior to adding the filter to the measurement chain.



**HARMONICS AND SPURIOUS EMISSIONS (LOW CHANNEL, VERTICAL)**

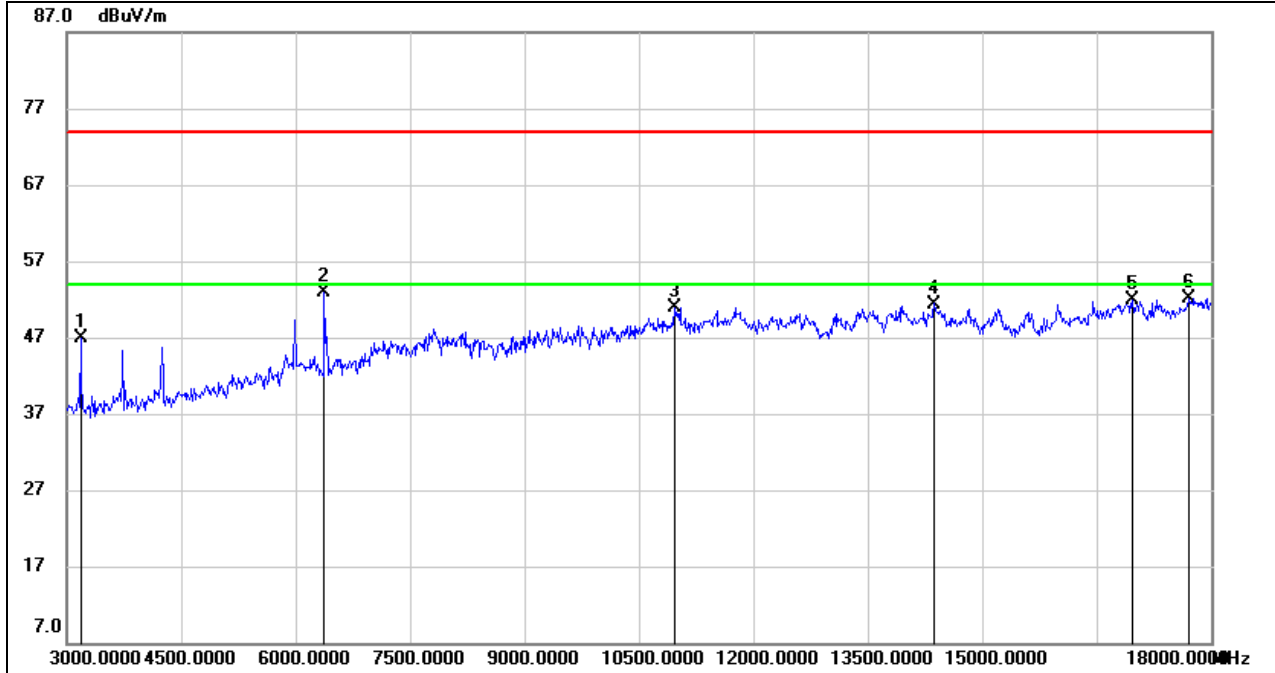

No.	Frequency (MHz)	Reading (dBuV)	Correct (dB/m)	Result (dBuV/m)	Limit (dBuV/m)	Margin (dB)	Remark
1	3180.000	51.12	-4.30	46.82	74.00	-27.18	peak
2	6375.000	47.81	5.08	52.89	74.00	-21.11	peak
3	10965.000	37.54	13.33	50.87	74.00	-23.13	peak
4	14370.000	34.74	16.66	51.40	74.00	-22.60	peak
5	16965.000	31.15	20.68	51.83	74.00	-22.17	peak
6	17715.000	29.55	22.65	52.20	74.00	-21.80	peak

- Note: 1. Peak Result = Reading Level + Correct Factor.  
 2. If Peak Result complies with AV limit, AV Result is deemed to comply with AV limit.  
 3. Peak: Peak detector.  
 4. Filter losses were only considered in the spurious frequency bands and the authorized band was not corrected for HPF losses.  
 5. Proper operation of the transmitter prior to adding the filter to the measurement chain.



**HARMONICS AND SPURIOUS EMISSIONS (MID CHANNEL, HORIZONTAL)**

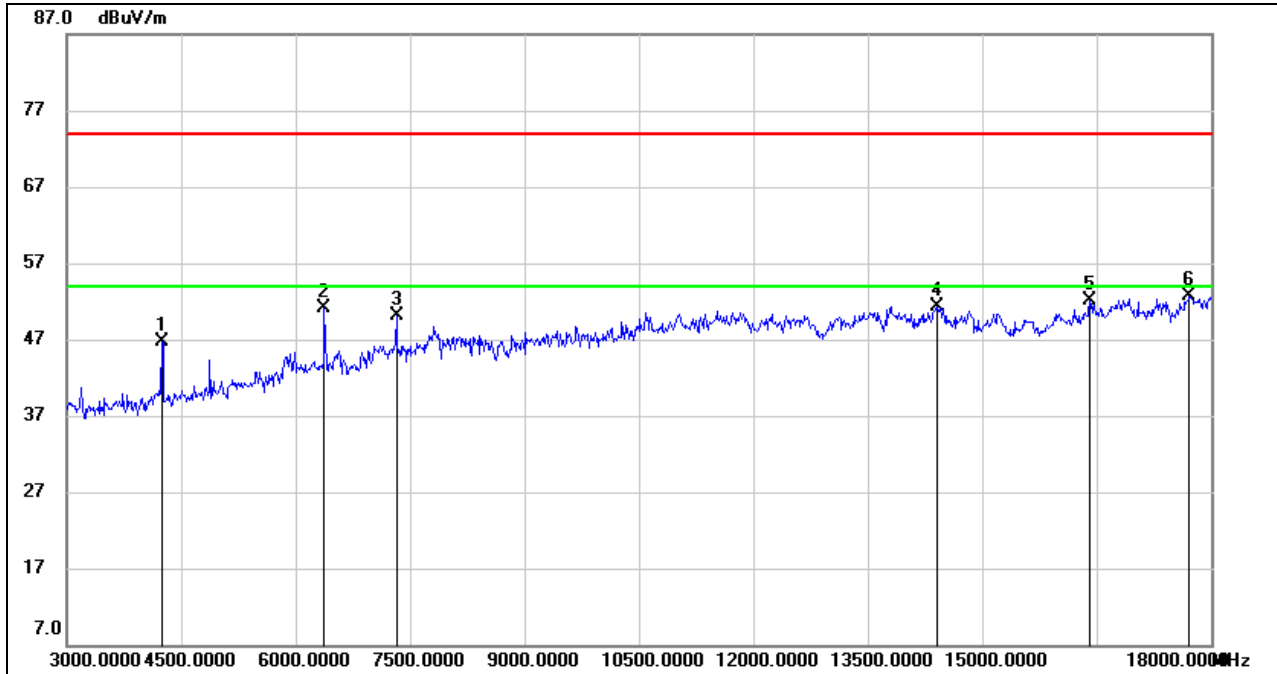

No.	Frequency (MHz)	Reading (dBuV)	Correct (dB/m)	Result (dBuV/m)	Limit (dBuV/m)	Margin (dB)	Remark
1	4245.000	48.42	-1.71	46.71	74.00	-27.29	peak
2	6375.000	46.01	5.08	51.09	74.00	-22.91	peak
3	7320.000	42.71	7.42	50.13	74.00	-23.87	peak
4	14400.000	34.56	16.68	51.24	74.00	-22.76	peak
5	16410.000	33.06	18.96	52.02	74.00	-21.98	peak
6	17715.000	30.09	22.65	52.74	74.00	-21.26	peak

- Note: 1. Peak Result = Reading Level + Correct Factor.  
 2. If Peak Result complies with AV limit, AV Result is deemed to comply with AV limit.  
 3. Peak: Peak detector.  
 4. Filter losses were only considered in the spurious frequency bands and the authorized band was not corrected for HPF losses.  
 5. Proper operation of the transmitter prior to adding the filter to the measurement chain.



**HARMONICS AND SPURIOUS EMISSIONS (MID CHANNEL, VERTICAL)**

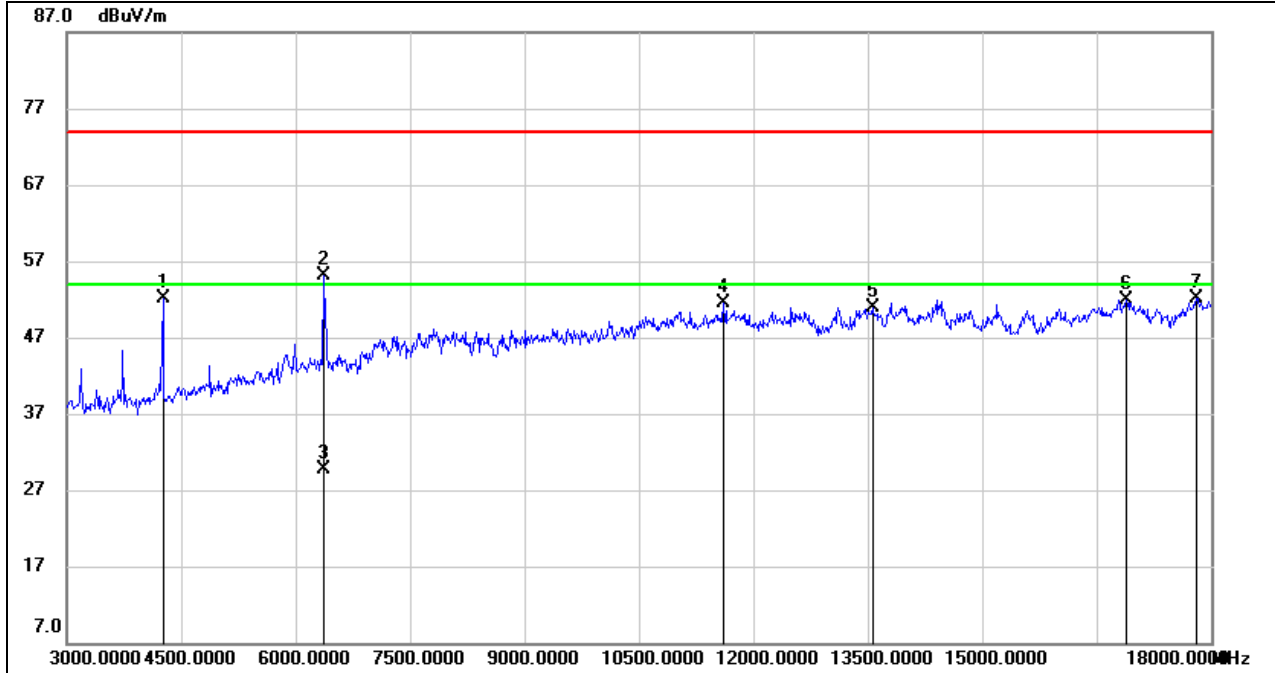

No.	Frequency (MHz)	Reading (dBuV)	Correct (dB/m)	Result (dBuV/m)	Limit (dBuV/m)	Margin (dB)	Remark
1	4260.000	53.90	-1.84	52.06	74.00	-21.94	peak
2	6360.000	50.00	5.03	55.03	74.00	-18.97	peak
3	6360.000	24.60	5.03	29.63	54.00	-24.37	AVG
4	11610.000	37.24	14.24	51.48	74.00	-22.52	peak
5	13560.000	34.58	16.29	50.87	74.00	-23.13	peak
6	16890.000	31.49	20.36	51.85	74.00	-22.15	peak
7	17805.000	28.75	23.34	52.09	74.00	-21.91	peak

- Note: 1. Peak Result = Reading Level + Correct Factor.  
 2. If Peak Result complies with AV limit, AV Result is deemed to comply with AV limit.  
 3. Peak: Peak detector.  
 4. AVG:  $VBW=1/T_{on}$  where:  $t_{on}$  is transmit duration.  
 5. For transmit duration, please refer to clause 6.1.  
 6. Filter losses were only considered in the spurious frequency bands and the authorized band was not corrected for HPF losses.  
 7. Proper operation of the transmitter prior to adding the filter to the measurement chain.





**HARMONICS AND SPURIOUS EMISSIONS (HIGH CHANNEL, HORIZONTAL)**

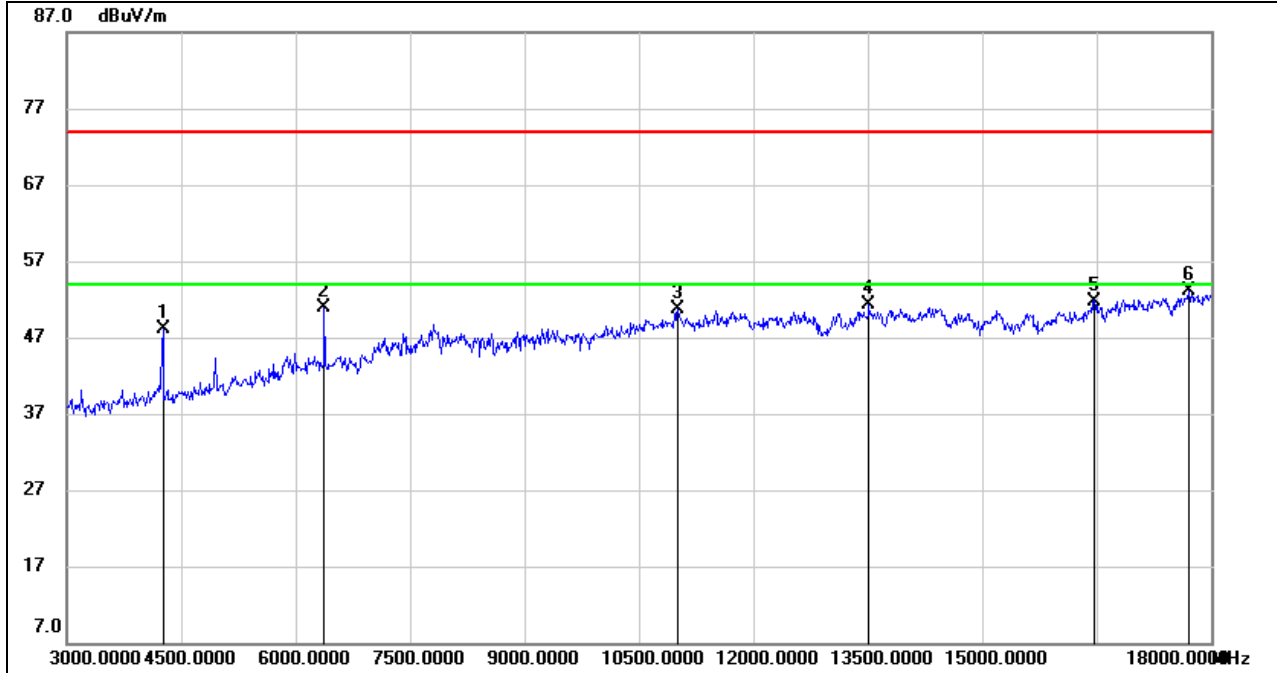

No.	Frequency (MHz)	Reading (dBuV)	Correct (dB/m)	Result (dBuV/m)	Limit (dBuV/m)	Margin (dB)	Remark
1	4260.000	49.91	-1.84	48.07	74.00	-25.93	peak
2	6375.000	45.87	5.08	50.95	74.00	-23.05	peak
3	11010.000	37.13	13.65	50.78	74.00	-23.22	peak
4	13515.000	35.15	16.14	51.29	74.00	-22.71	peak
5	16470.000	32.57	19.23	51.80	74.00	-22.20	peak
6	17715.000	30.50	22.65	53.15	74.00	-20.85	peak

- Note: 1. Peak Result = Reading Level + Correct Factor.  
 2. If Peak Result complies with AV limit, AV Result is deemed to comply with AV limit.  
 3. Peak: Peak detector.  
 4. Filter losses were only considered in the spurious frequency bands and the authorized band was not corrected for HPF losses.  
 5. Proper operation of the transmitter prior to adding the filter to the measurement chain.



**HARMONICS AND SPURIOUS EMISSIONS (HIGH CHANNEL, VERTICAL)**

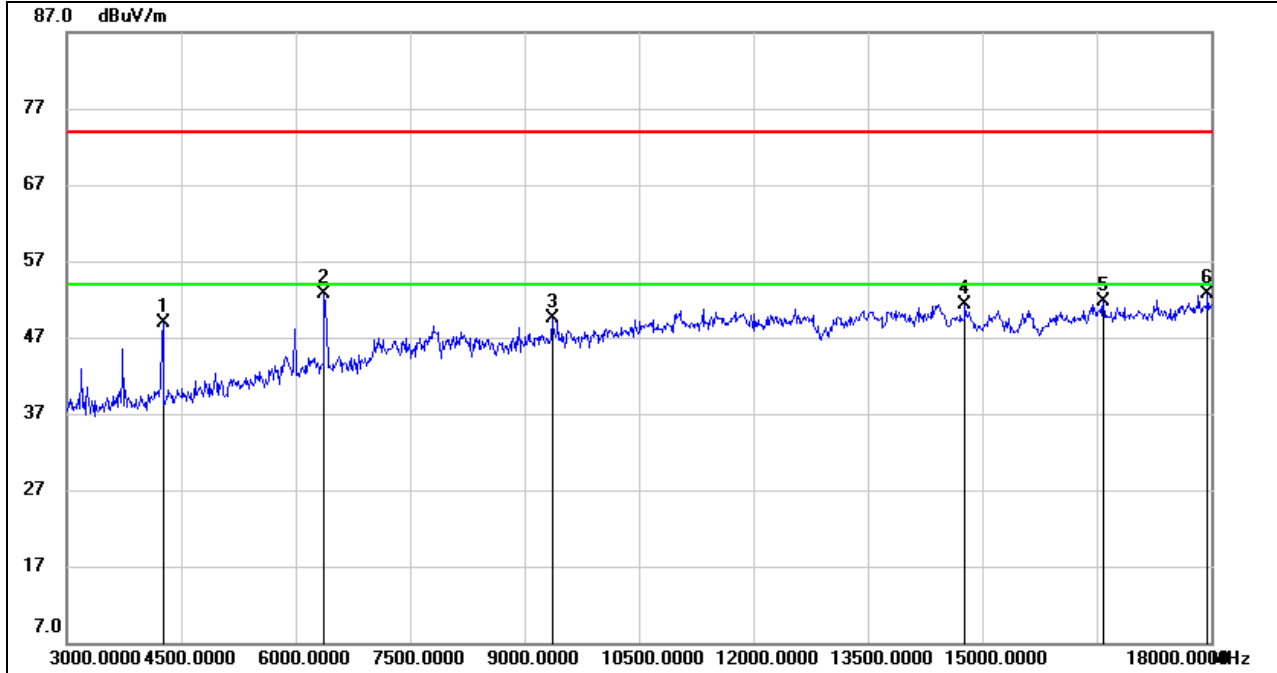

No.	Frequency (MHz)	Reading (dBuV)	Correct (dB/m)	Result (dBuV/m)	Limit (dBuV/m)	Margin (dB)	Remark
1	4260.000	50.69	-1.84	48.85	74.00	-25.15	peak
2	6375.000	47.66	5.08	52.74	74.00	-21.26	peak
3	9360.000	39.07	10.40	49.47	74.00	-24.53	peak
4	14775.000	35.35	16.03	51.38	74.00	-22.62	peak
5	16590.000	31.94	19.67	51.61	74.00	-22.39	peak
6	17955.000	29.24	23.38	52.62	74.00	-21.38	peak

- Note: 1. Peak Result = Reading Level + Correct Factor.  
 2. If Peak Result complies with AV limit, AV Result is deemed to comply with AV limit.  
 3. Peak: Peak detector.  
 4. Filter losses were only considered in the spurious frequency bands and the authorized band was not corrected for HPF losses.  
 5. Proper operation of the transmitter prior to adding the filter to the measurement chain.



## 8.4. SPURIOUS EMISSIONS 18G ~ 26GHz

### 8.4.1. GFSK(2Mbps) MODE

#### SPURIOUS EMISSIONS (MID CHANNEL, WORST-CASE CONFIGURATION, HORIZONTAL)

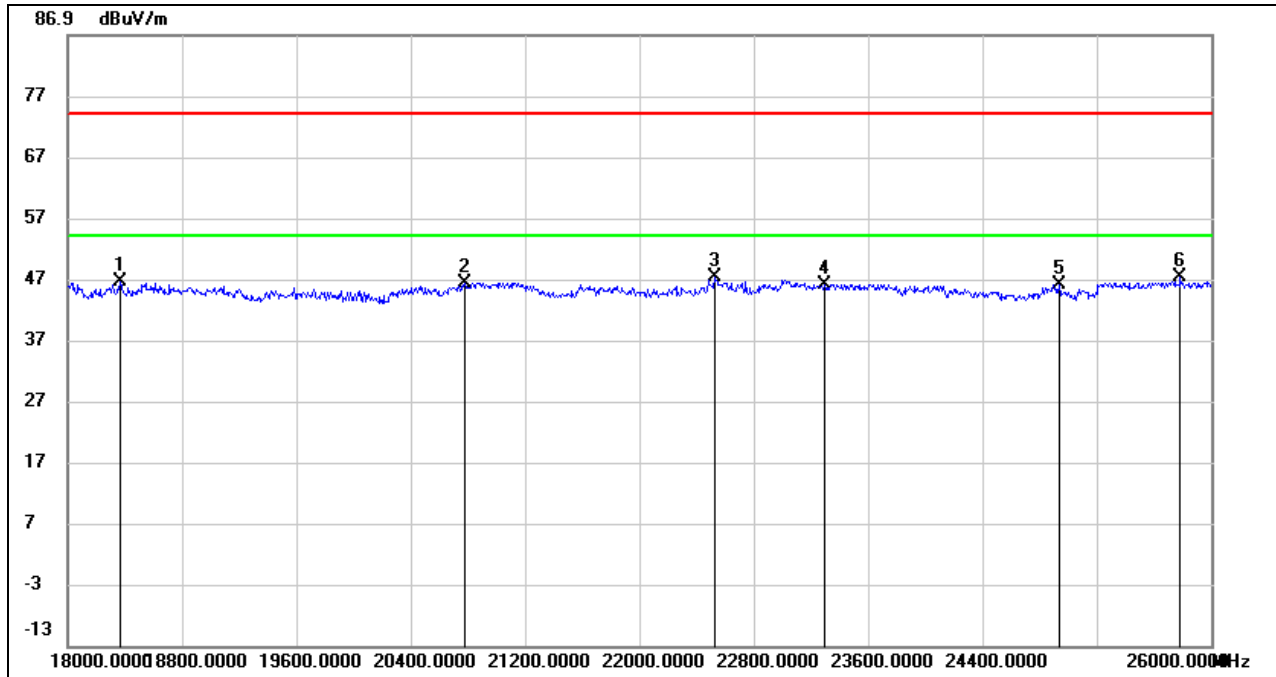

No.	Frequency (MHz)	Reading (dBuV)	Correct (dB/m)	Result (dBuV/m)	Limit (dBuV/m)	Margin (dB)	Remark
1	18368.000	51.01	-4.38	46.63	74.00	-27.37	peak
2	20776.000	51.53	-5.14	46.39	74.00	-27.61	peak
3	22528.000	53.16	-5.79	47.37	74.00	-26.63	peak
4	23296.000	51.30	-5.16	46.14	74.00	-27.86	peak
5	24936.000	47.37	-1.30	46.07	74.00	-27.93	peak
6	25784.000	48.73	-1.49	47.24	74.00	-26.76	peak

- Note: 1. Peak Result = Reading Level + Correct Factor.  
 2. If Peak Result complies with AV limit, AV Result is deemed to comply with AV limit.  
 3. Peak: Peak detector.



**SPURIOUS EMISSIONS (MID CHANNEL, WORST-CASE CONFIGURATION, VERTICAL)**

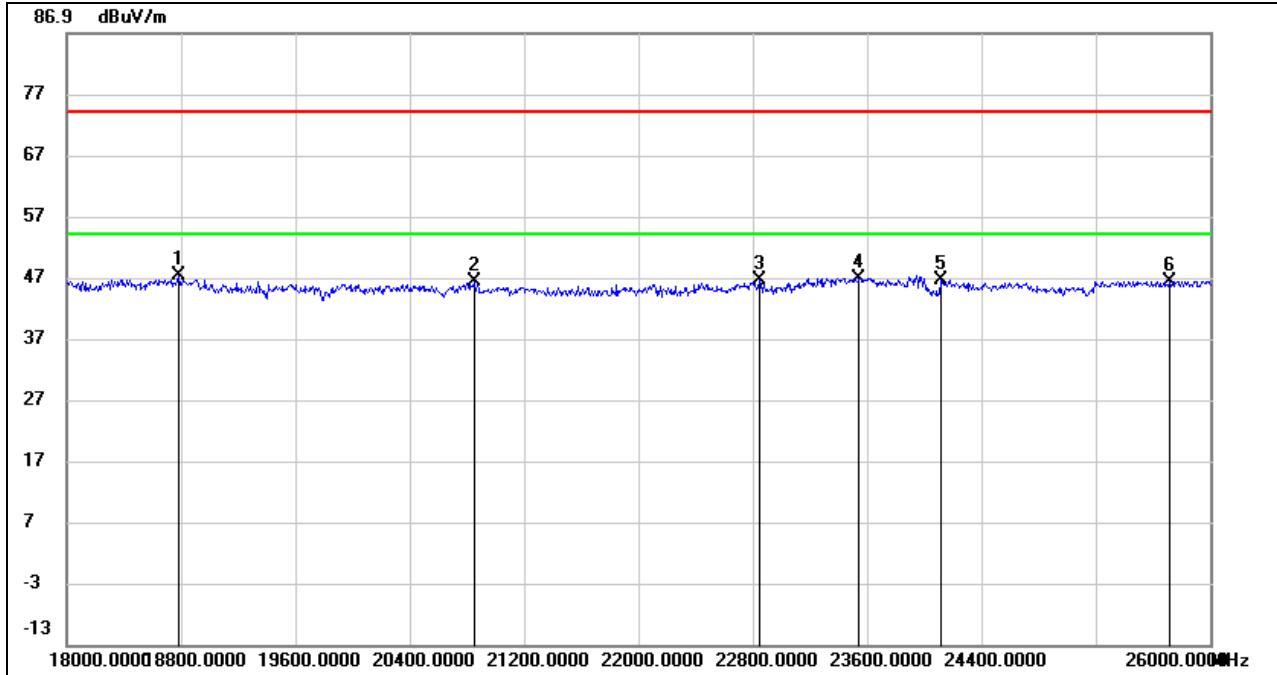

No.	Frequency (MHz)	Reading (dBuV)	Correct (dB/m)	Result (dBuV/m)	Limit (dBuV/m)	Margin (dB)	Remark
1	18784.000	52.05	-4.84	47.21	74.00	-26.79	peak
2	20848.000	51.54	-5.19	46.35	74.00	-27.65	peak
3	22848.000	52.10	-5.69	46.41	74.00	-27.59	peak
4	23544.000	51.63	-4.73	46.90	74.00	-27.10	peak
5	24120.000	50.28	-3.81	46.47	74.00	-27.53	peak
6	25720.000	47.78	-1.39	46.39	74.00	-27.61	peak

- Note: 1. Peak Result = Reading Level + Correct Factor.  
 2. If Peak Result complies with AV limit, AV Result is deemed to comply with AV limit.  
 3. Peak: Peak detector.

Note: All test mode has been tested, only the worst data record in the report.



## 8.4. SPURIOUS EMISSIONS 30M ~ 1 GHz

### 8.4.1. GFSK(2Mbps) MODE

#### SPURIOUS EMISSIONS (MID CHANNEL, WORST-CASE CONFIGURATION, HORIZONTAL)

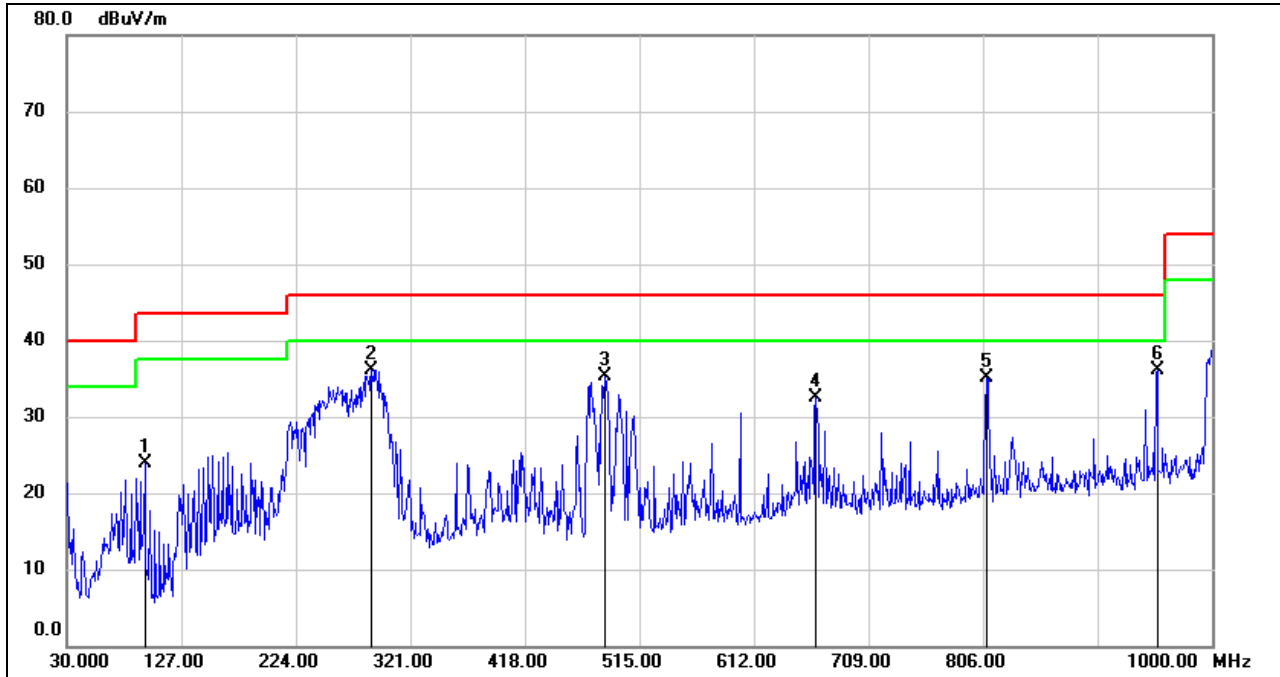

No.	Frequency (MHz)	Reading (dBuV)	Correct (dB/m)	Result (dBuV/m)	Limit (dBuV/m)	Margin (dB)	Remark
1	95.9600	45.37	-21.51	23.86	43.50	-19.64	QP
2	288.0200	50.69	-14.50	36.19	46.00	-9.81	QP
3	485.9000	46.06	-10.72	35.34	46.00	-10.66	QP
4	664.3800	39.85	-7.26	32.59	46.00	-13.41	QP
5	808.9099	40.35	-5.27	35.08	46.00	-10.92	QP
6	953.4400	39.50	-3.37	36.13	46.00	-9.87	QP

- Note: 1. Result Level = Read Level + Correct Factor.  
 2. If Peak Result complies with QP limit, QP Result is deemed to comply with QP limit.  
 3. Test setup: RBW: 120 kHz, VBW: 300 kHz, Sweep time: auto.



**SPURIOUS EMISSIONS (MID CHANNEL, WORST-CASE CONFIGURATION, VERTICAL)**

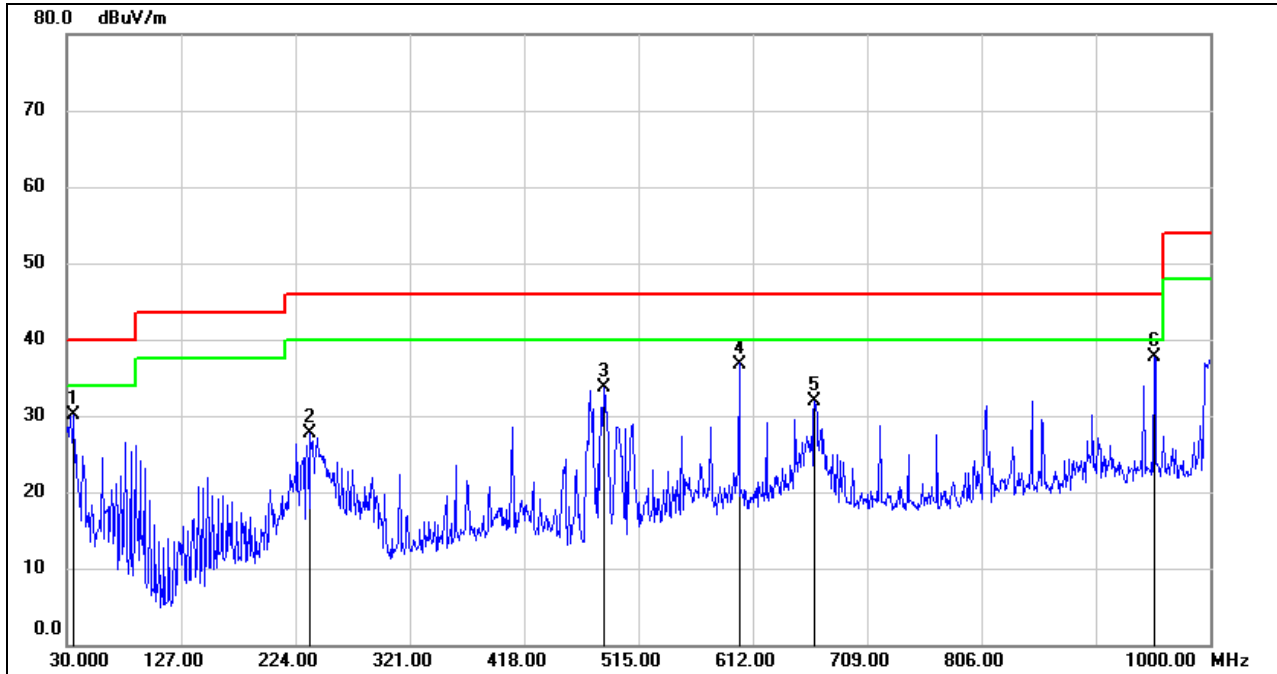

No.	Frequency (MHz)	Reading (dBuV)	Correct (dB/m)	Result (dBuV/m)	Limit (dBuV/m)	Margin (dB)	Remark
1	35.8200	47.74	-17.63	30.11	40.00	-9.89	QP
2	236.6100	45.17	-17.47	27.70	46.00	-18.30	QP
3	485.9000	44.47	-10.72	33.75	46.00	-12.25	QP
4	600.3600	45.22	-8.42	36.80	46.00	-9.20	QP
5	664.3800	39.24	-7.26	31.98	46.00	-14.02	QP
6	952.4700	41.08	-3.36	37.72	46.00	-8.28	QP

- Note: 1. Result Level = Read Level + Correct Factor.  
 2. If Peak Result complies with QP limit, QP Result is deemed to comply with QP limit.  
 3. Test setup: RBW: 120 kHz, VBW: 300 kHz, Sweep time: auto

Note: All test mode has been tested, only the worst data record in the report.

## 8.5. SPURIOUS EMISSIONS BELOW 30M

### 8.5.1. GFSK(2Mbps) MODE

#### SPURIOUS EMISSIONS (MID CHANNEL, LOOP ANTENNA FACE ON TO THE EUT, WORST-CASE CONFIGURATION)

9kHz~ 150kHz

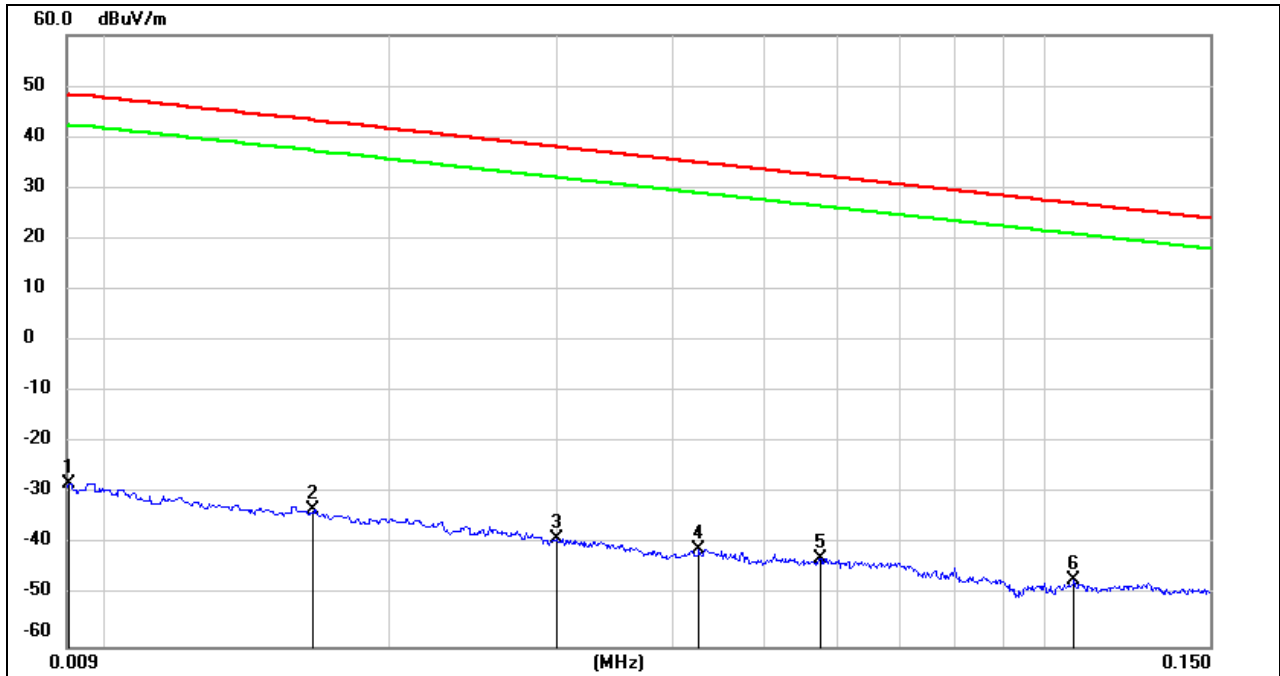

No.	Frequency (MHz)	Reading (dBuV)	Correct (dB/m)	Result (dBuV/m)	Limit (dBuV/m)	Margin (dB)	Remark
1	0.0091	73.29	-101.33	-28.04	48.28	-76.32	peak
2	0.0165	68.34	-101.37	-33.03	43.25	-76.28	peak
3	0.0300	62.68	-101.39	-38.71	38.06	-76.77	peak
4	0.0427	60.64	-101.45	-40.81	34.99	-75.80	peak
5	0.0575	58.91	-101.51	-42.60	32.41	-75.01	peak
6	0.1073	54.80	-101.77	-46.97	26.99	-73.96	peak

Note: 1. Measurement = Reading Level + Correct Factor.

2. If Peak Result complies with AV and QP limit, AV and QP Result are deemed to comply with AV limit.

3. All 3 polarizations(Horizontal, Face-on and Face-off) of the loop antenna had been tested, but only the worst data recorded in the report.



**150kHz ~ 490kHz**

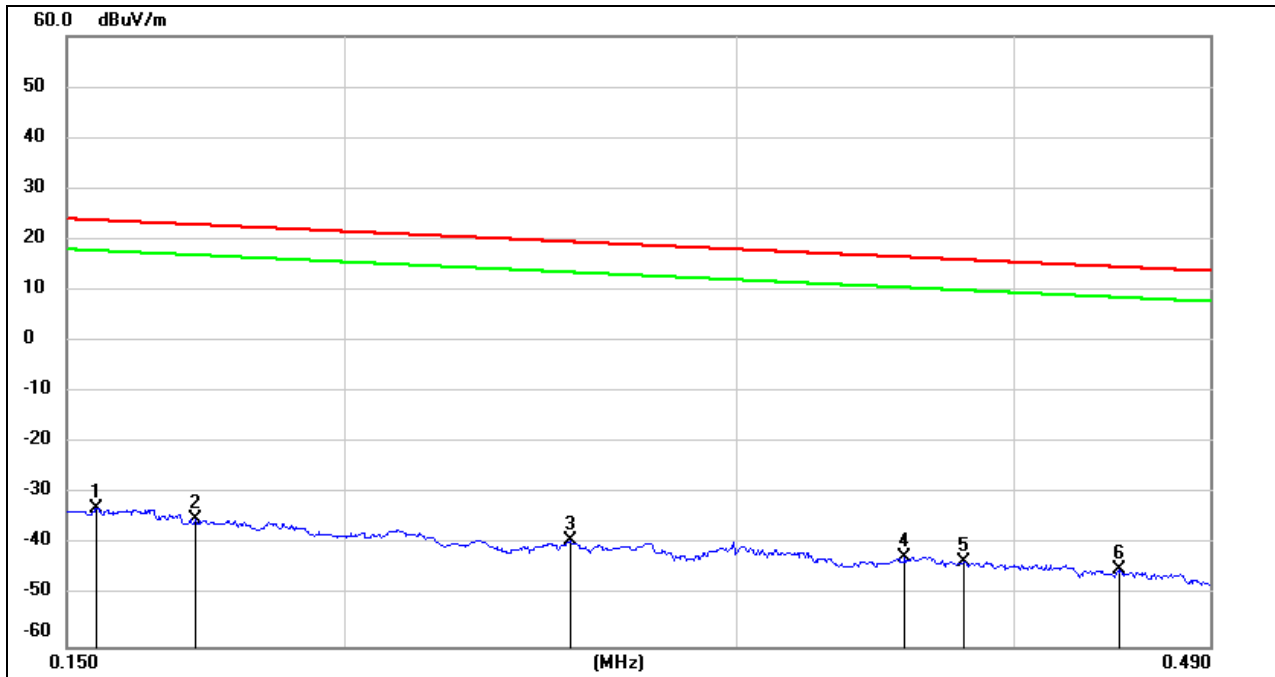

No.	Frequency (MHz)	Reading (dBuV)	Correct (dB/m)	Result (dBuV/m)	Limit (dBuV/m)	Margin (dB)	Remark
1	0.1547	68.81	-101.65	-32.84	23.81	-56.65	peak
2	0.1713	66.66	-101.67	-35.01	22.93	-57.94	peak
3	0.2530	62.59	-101.80	-39.21	19.54	-58.75	peak
4	0.3573	59.58	-101.91	-42.33	16.54	-58.87	peak
5	0.3800	58.52	-101.94	-43.42	16.01	-59.43	peak
6	0.4460	57.08	-102.01	-44.93	14.62	-59.55	peak

Note: 1. Measurement = Reading Level + Correct Factor.  
 2. If Peak Result complies with AV and QP limit, AV and QP Result are deemed to comply with AV limit.  
 3. All 3 polarizations(Horizontal, Face-on and Face-off) of the loop antenna had been tested, but only the worst data recorded in the report.





**490kHz ~ 30MHz**

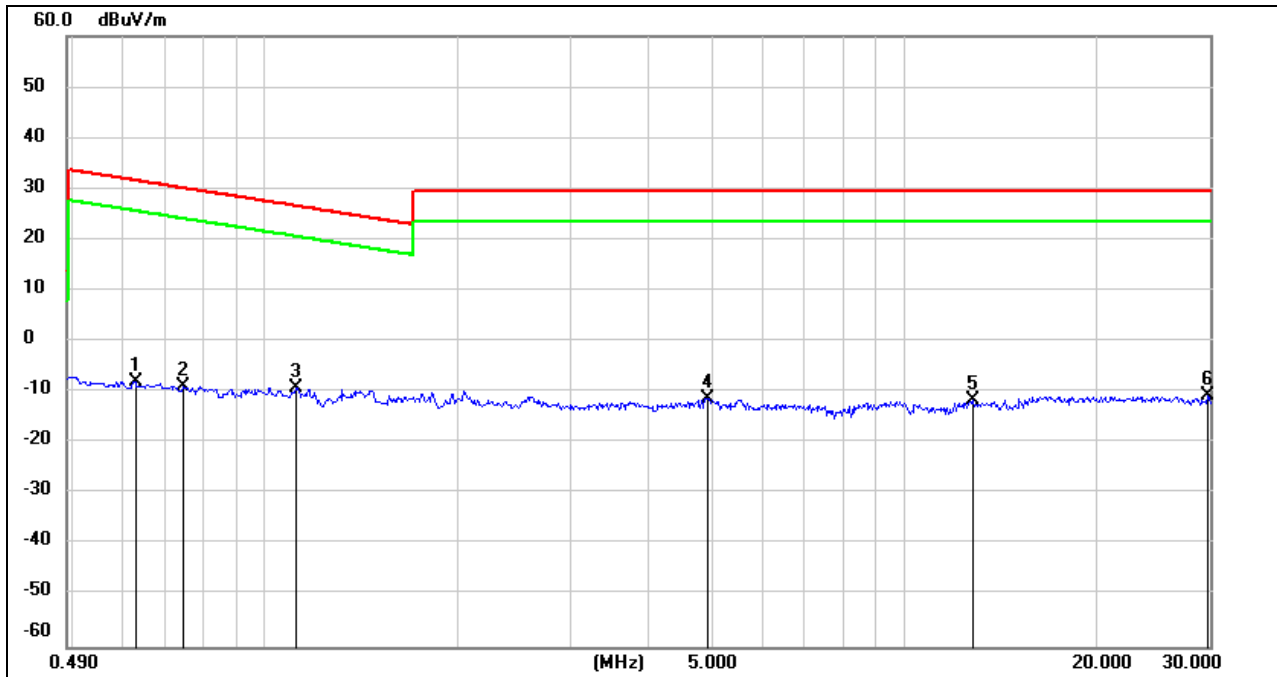

No.	Frequency (MHz)	Reading (dBuV)	Correct (dB/m)	Result (dBuV/m)	Limit (dBuV/m)	Margin (dB)	Remark
1	0.6270	54.15	-62.09	-7.94	31.66	-39.60	peak
2	0.7455	53.16	-62.11	-8.95	30.15	-39.10	peak
3	1.1152	53.22	-62.22	-9.00	26.66	-35.66	peak
4	4.9165	50.38	-61.48	-11.10	29.54	-40.64	peak
5	12.7660	49.40	-60.92	-11.52	29.54	-41.06	peak
6	29.7637	49.25	-59.99	-10.74	29.54	-40.28	peak

Note: 1. Measurement = Reading Level + Correct Factor.

2. If Peak Result complies with AV and QP limit, AV and QP Result are deemed to comply with AV limit.

3. All 3 polarizations(Horizontal, Face-on and Face-off) of the loop antenna had been tested, but only the worst data recorded in the report.

Note: All test mode has been tested, only the worst data record in the report.

## 9. AC POWER LINE CONDUCTED EMISSIONS

### LIMITS

Please refer to CFR 47 FCC §15.207 (a) and ISED RSS-Gen Clause 8.8

FREQUENCY (MHz)	Quasi-peak	Average
0.15 -0.5	66 - 56 *	56 - 46 *
0.50 -5.0	56.00	46.00
5.0 -30.0	60.00	50.00

### TEST SETUP AND PROCEDURE

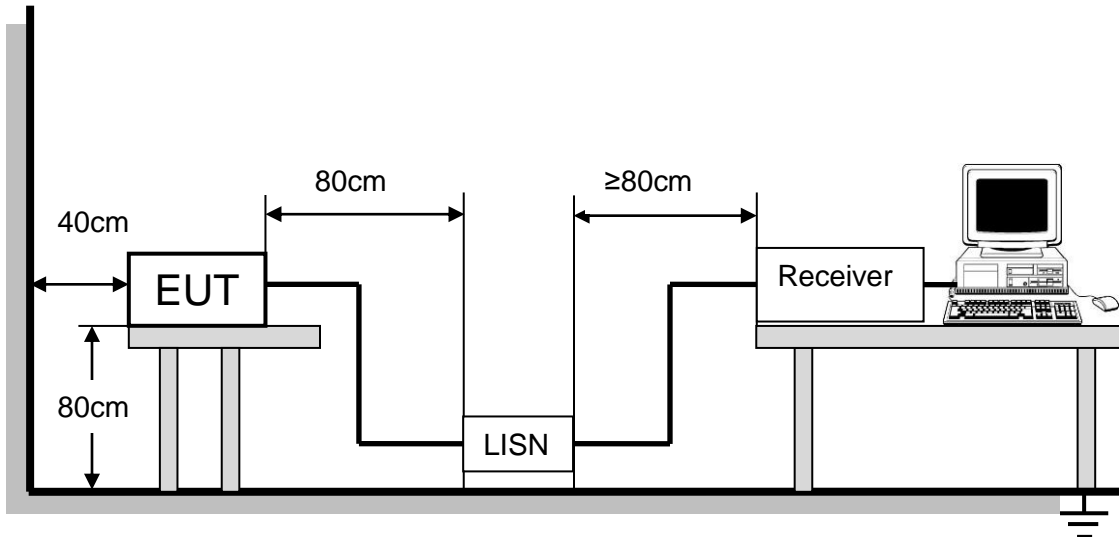

The EUT is put on a table of non-conducting material that is 80cm high. The vertical conducting wall of shielding is located 40cm to the rear of the EUT. The power line of the EUT is connected to the AC mains through a Artificial Mains Network (A.M.N.). A EMI Measurement Receiver (R&S Test Receiver ESR3) is used to test the emissions from both sides of AC line. According to the requirements in Section 6.2 of ANSI C63.10-2013. Conducted emissions from the EUT measured in the frequency range between 0.15 MHz and 30MHz using CISPR Quasi-Peak and average detector mode. The bandwidth of EMI test receiver is set at 9kHz. The arrangement of the equipment is installed to meet the standards and operating in a manner, which tends to maximize its emission characteristics in a normal application.



### 9.1.1. GFSK(2Mbps) MODE

#### LINE L RESULTS (MID CHANNEL, WORST-CASE CONFIGURATION)

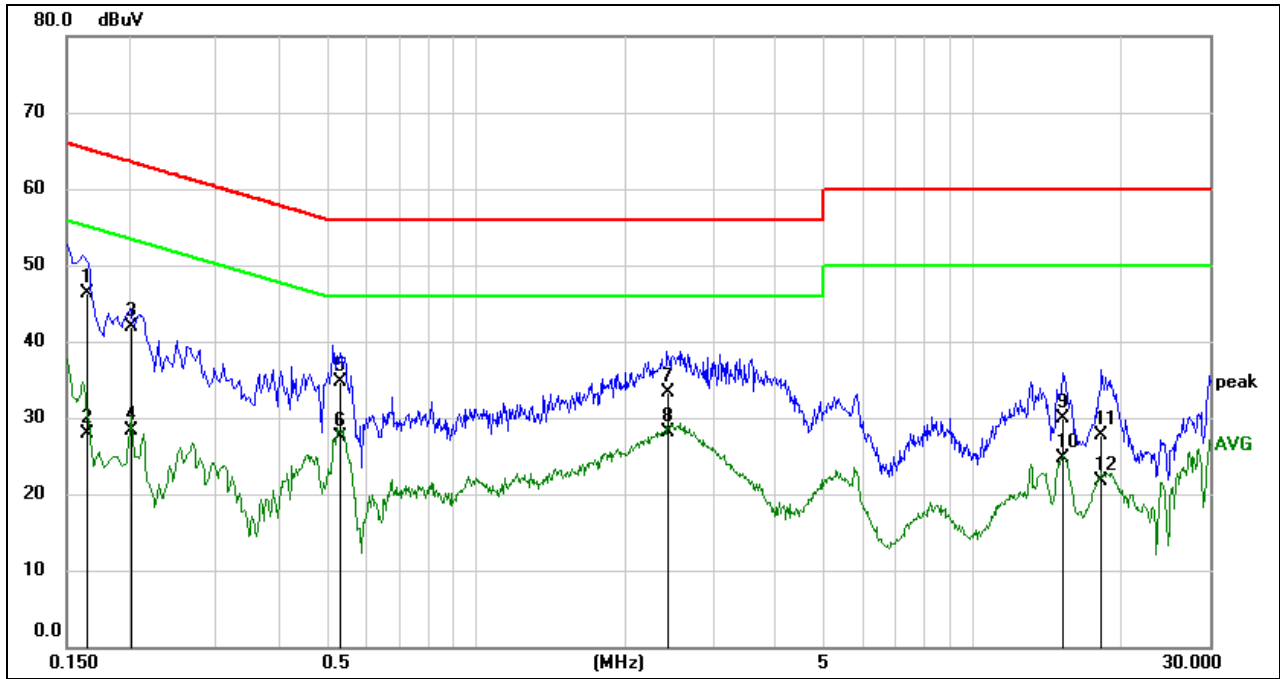

No.	Frequency (MHz)	Reading (dBuV)	Correct (dB)	Result (dBuV)	Limit (dBuV)	Margin (dB)	Remark
1	0.1655	36.78	9.61	46.39	65.18	-18.79	QP
2	0.1655	18.30	9.61	27.91	55.18	-27.27	AVG
3	0.2019	32.31	9.60	41.91	63.53	-21.62	QP
4	0.2019	18.73	9.60	28.33	53.53	-25.20	AVG
5	0.5313	25.12	9.60	34.72	56.00	-21.28	QP
6	0.5313	17.99	9.60	27.59	46.00	-18.41	AVG
7	2.4537	23.70	9.63	33.33	56.00	-22.67	QP
8	2.4537	18.41	9.63	28.04	46.00	-17.96	AVG
9	15.2406	20.10	9.86	29.96	60.00	-30.04	QP
10	15.2406	14.77	9.86	24.63	50.00	-25.37	AVG
11	18.1673	17.60	10.02	27.62	60.00	-32.38	QP
12	18.1673	11.59	10.02	21.61	50.00	-28.39	AVG

- Note: 1. Result = Reading +Correct Factor.  
 2. If QP Result complies with AV limit, AV Result is deemed to comply with AV limit.  
 3. Test setup: RBW: 200 Hz (9 kHz—150 kHz), 9 kHz (150 kHz—30 MHz).  
 4. Step size: 80Hz (0.009MHz-0.15MHz), 4 kHz (0.15MHz-30MHz), Scan time: auto.



**LINE N RESULTS (MID CHANNEL, WORST-CASE CONFIGURATION)**

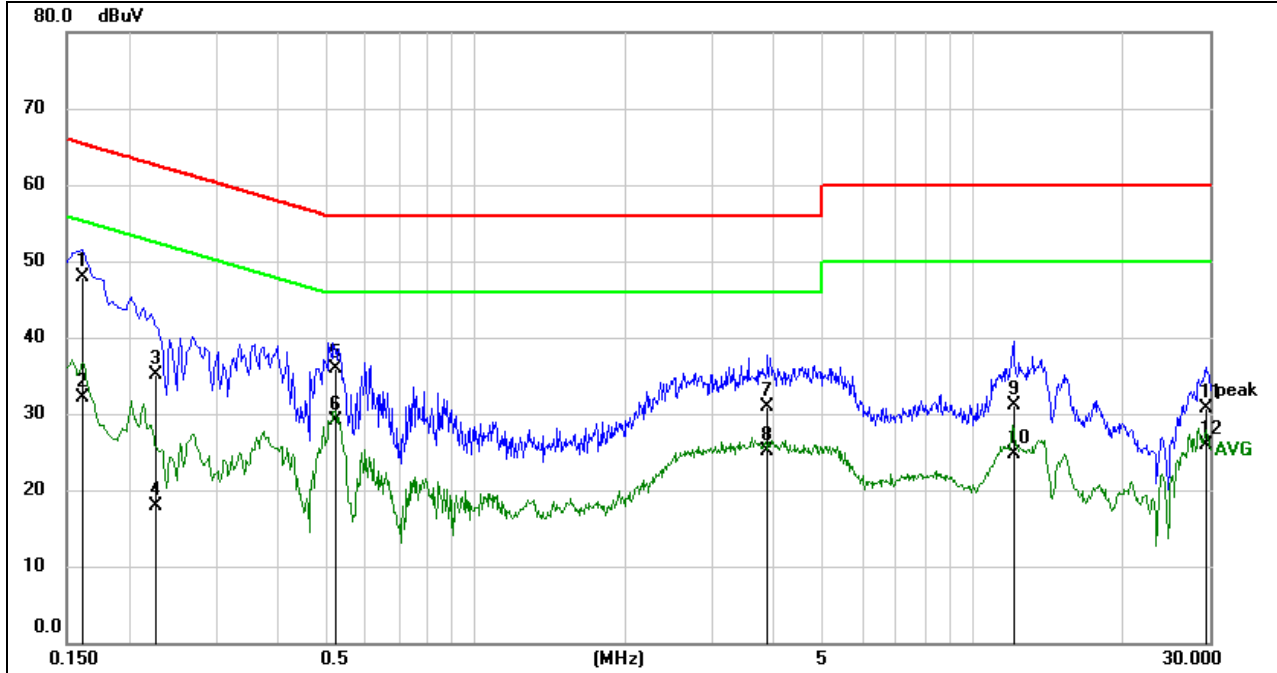

No.	Frequency (MHz)	Reading (dBuV)	Correct (dB)	Result (dBuV)	Limit (dBuV)	Margin (dB)	Remark
1	0.1621	38.39	9.60	47.99	65.36	-17.37	QP
2	0.1621	22.46	9.60	32.06	55.36	-23.30	AVG
3	0.2274	25.46	9.60	35.06	62.54	-27.48	QP
4	0.2274	8.32	9.60	17.92	52.54	-34.62	AVG
5	0.5228	26.37	9.60	35.97	56.00	-20.03	QP
6	0.5228	19.46	9.60	29.06	46.00	-16.94	AVG
7	3.8389	21.15	9.66	30.81	56.00	-25.19	QP
8	3.8389	15.52	9.66	25.18	46.00	-20.82	AVG
9	12.0479	21.27	9.81	31.08	60.00	-28.92	QP
10	12.0479	14.91	9.81	24.72	50.00	-25.28	AVG
11	29.5999	20.89	9.89	30.78	60.00	-29.22	QP
12	29.5999	15.94	9.89	25.83	50.00	-24.17	AVG

- Note: 1. Result = Reading +Correct Factor.  
 2. If QP Result complies with AV limit, AV Result is deemed to comply with AV limit.  
 3. Test setup: RBW: 200 Hz (9 kHz—150 kHz), 9 kHz (150 kHz—30 MHz).  
 4. Step size: 80Hz (0.009MHz-0.15MHz), 4 kHz (0.15MHz-30MHz), Scan time: auto.

Note: All test mode has been tested, only the worst data record in the report.



## 10. ANTENNA REQUIREMENTS

### Applicable requirements

Please refer to FCC §15.203

An intentional radiator shall be designed to ensure that no antenna other than that furnished by the responsible party shall be used with the device. The use of a permanently attached antenna or of an antenna that uses a unique coupling to the intentional radiator shall be considered sufficient to comply with the provisions of this section. The manufacturer may design the unit so that a broken antenna can be replaced by the user, but the use of a standard antenna jack or electrical connector is prohibited.

Please refer to FCC §15.247(b)(4)

The conducted output power limit specified in paragraph (b) of this section is based on the use of antennas with directional gains that do not exceed 6 dBi. Except as shown in paragraph (c) of this section, if transmitting antennas of directional gain greater than 6 dBi are used, the conducted output power from the intentional radiator shall be reduced below the stated values in paragraphs (b)(1), (b)(2), and (b)(3) of this section, as appropriate, by the amount in dB that the directional gain of the antenna exceeds 6 dBi.

### RESULTS

Complies

END OF REPORT