

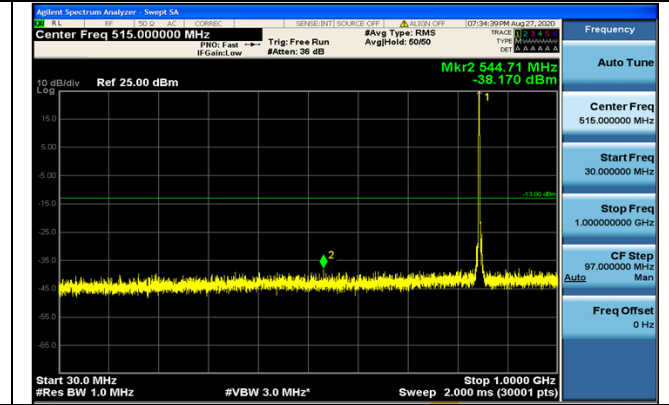

LTE FDD Band 5-3MHz Channel Bandwidth High Channel

QPSK

16QAM

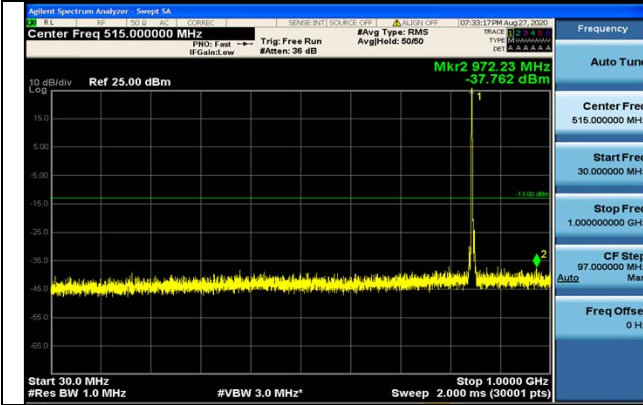

30MHz~1GHz

30MHz~1GHz



1GHz ~5GHz

1GHz ~5GHz

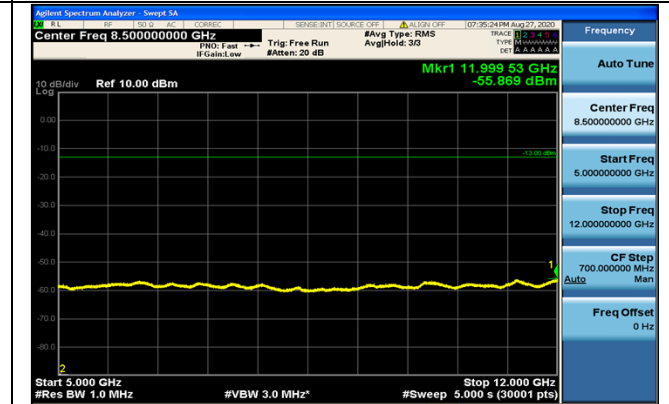

5GHz ~12GHz

5GHz ~12GHz

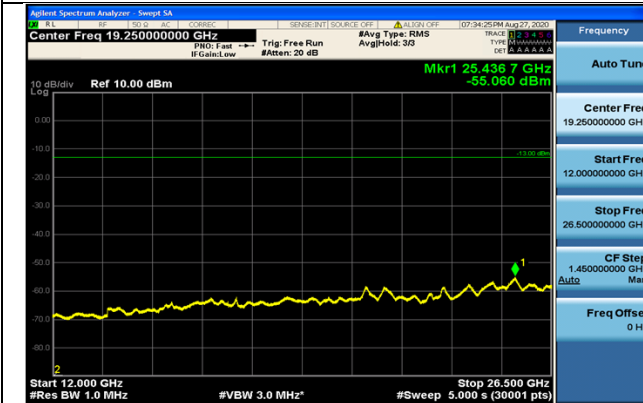

12GHz ~26.5GHz

12GHz ~26.5GHz

1RB#0

1RB#0



LTE FDD Band 5-5 MHz Channel Bandwidth
Low Channel

QPSK

16QAM

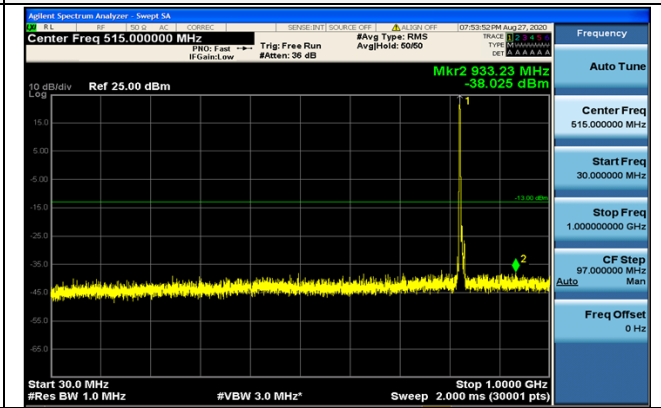
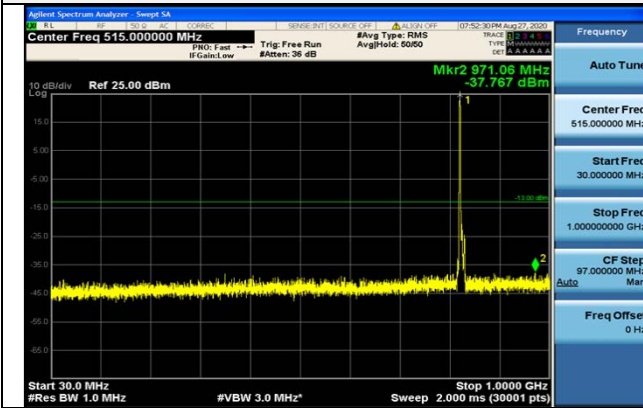

30MHz~1GHz

30MHz~1GHz



1GHz ~5GHz

1GHz ~5GHz

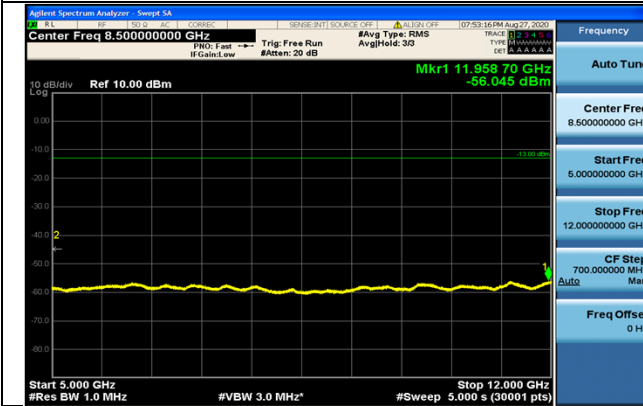

5GHz ~12GHz

5GHz ~12GHz

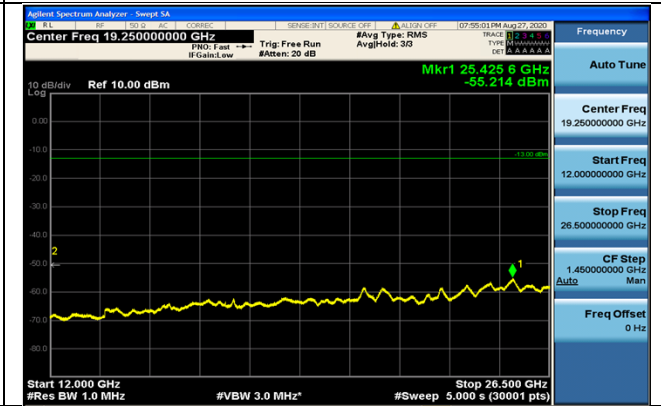

12GHz ~26.5GHz

12GHz ~26.5GHz

1RB#0

1RB#0



LTE FDD Band 5-5 MHz Channel Bandwidth
Middle Channel

QPSK

16QAM

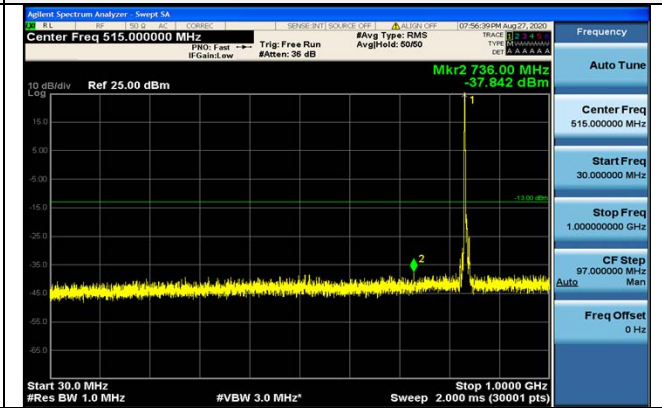
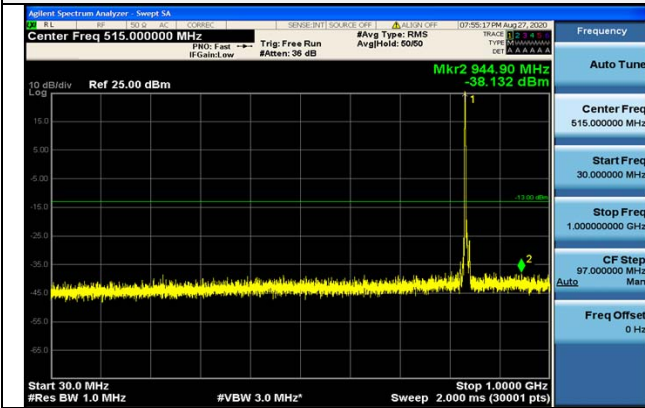

30MHz~1GHz

30MHz~1GHz

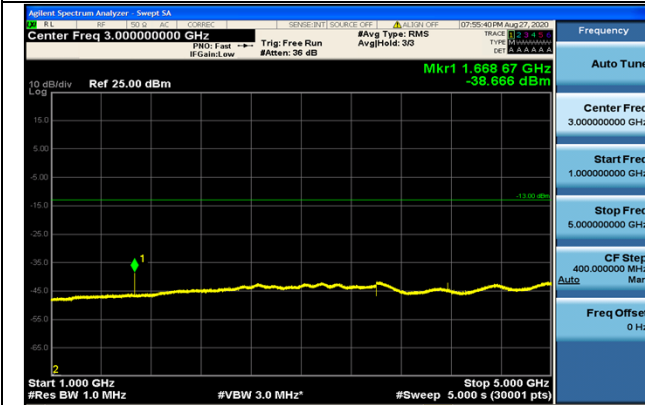

1GHz ~5GHz

1GHz ~5GHz



5GHz ~12GHz

5GHz ~12GHz

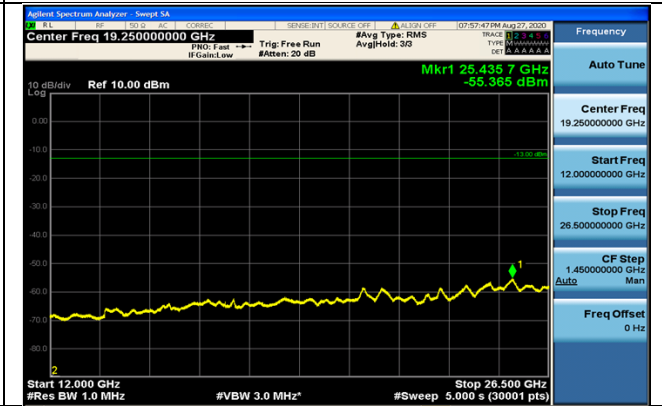

12GHz ~26.5GHz

12GHz ~26.5GHz

1RB#0

1RB#0



LTE FDD Band 5-5 MHz Channel Bandwidth High Channel

QPSK

16QAM

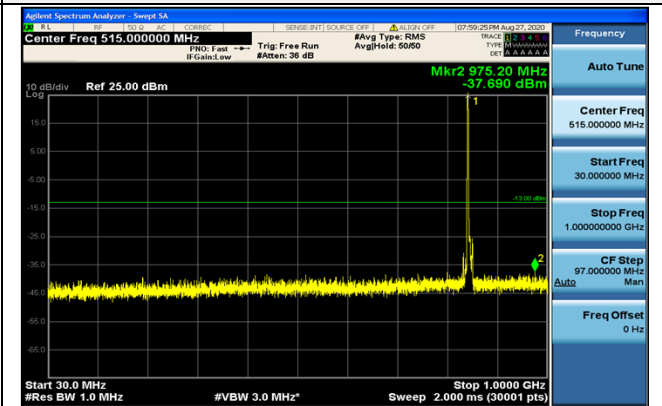
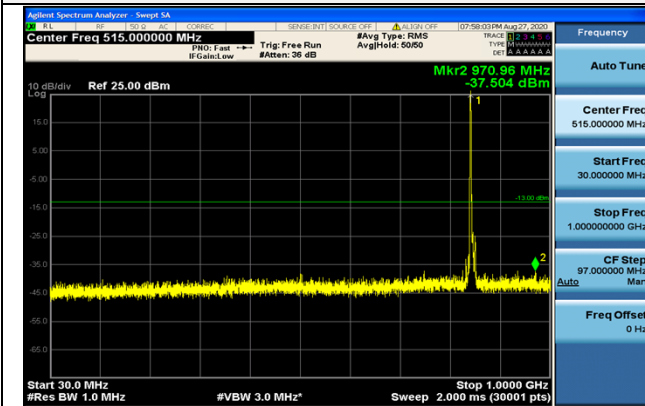

30MHz~1GHz

30MHz~1GHz



1GHz ~5GHz

1GHz ~5GHz

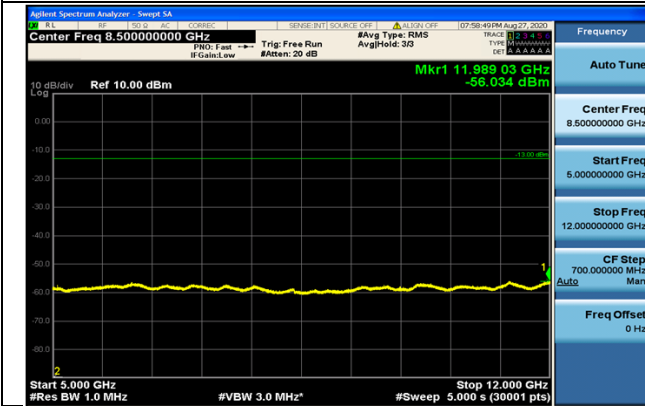

5GHz ~12GHz

5GHz ~12GHz



12GHz ~26.5GHz

12GHz ~26.5GHz

1RB#0

1RB#0



LTE FDD Band 5-10 MHz Channel Bandwidth Low Channel

QPSK

16QAM

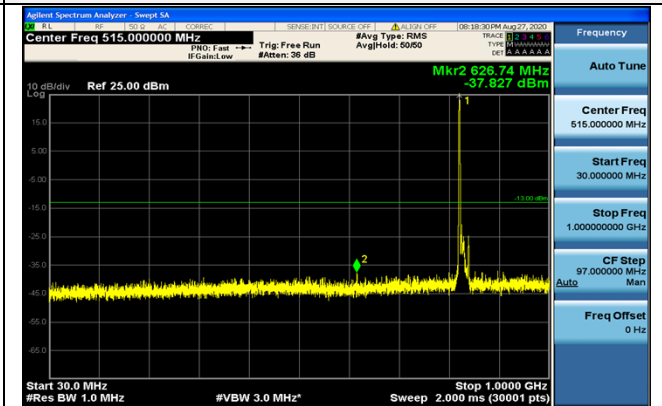
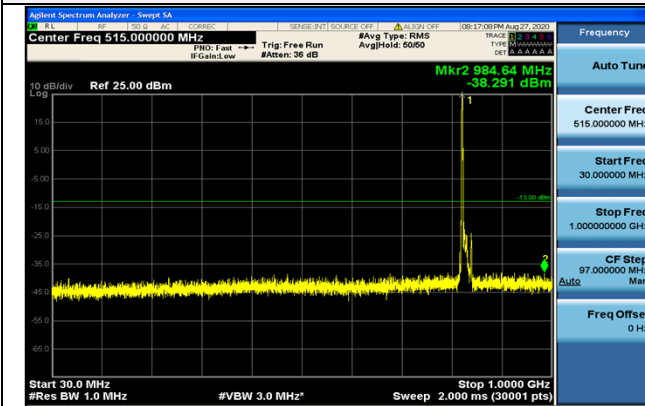

30MHz~1GHz

30MHz~1GHz

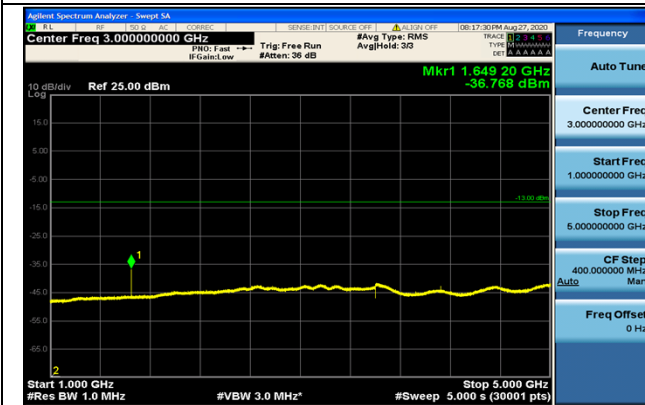

1GHz ~5GHz

1GHz ~5GHz

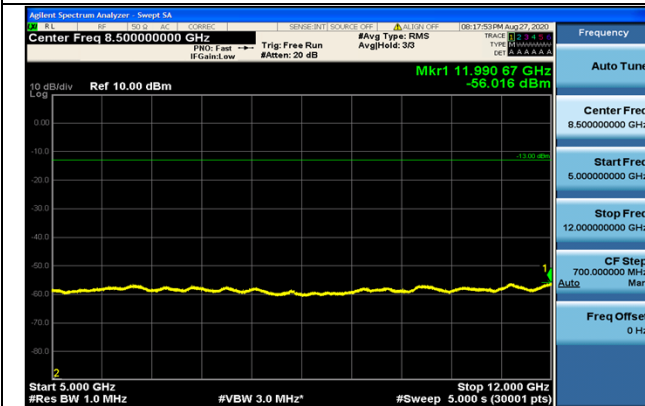

5GHz ~12GHz

5GHz ~12GHz

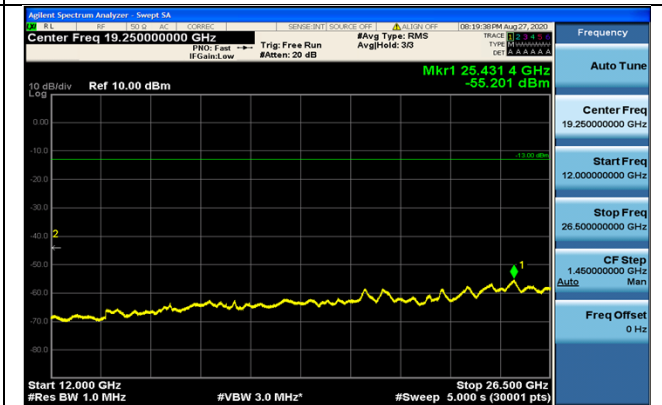

12GHz ~26.5GHz

12GHz ~26.5GHz

1RB#0

1RB#0



LTE FDD Band 5-10 MHz Channel Bandwidth
Middle Channel

QPSK

16QAM

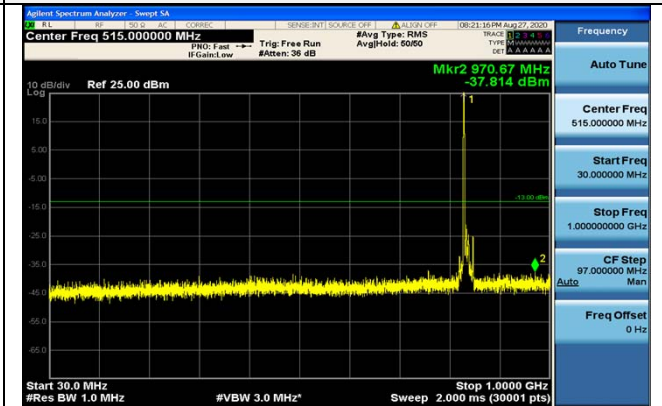
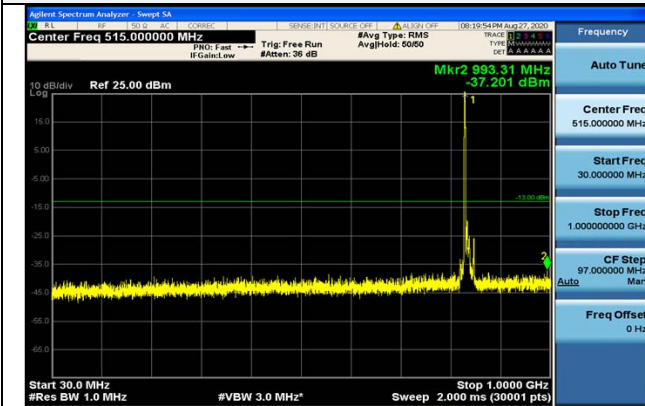

30MHz~1GHz

30MHz~1GHz



1GHz ~5GHz

1GHz ~5GHz



5GHz ~12GHz

5GHz ~12GHz

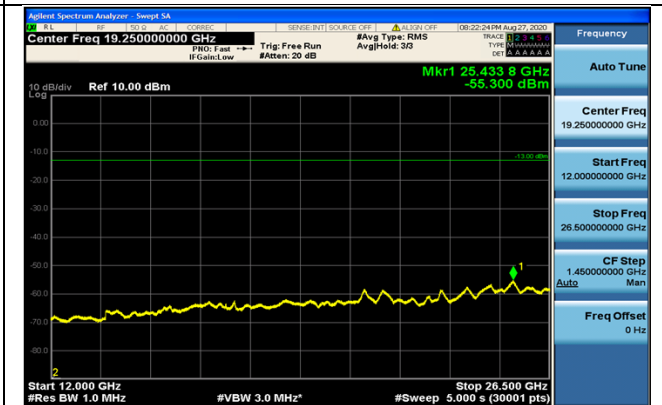
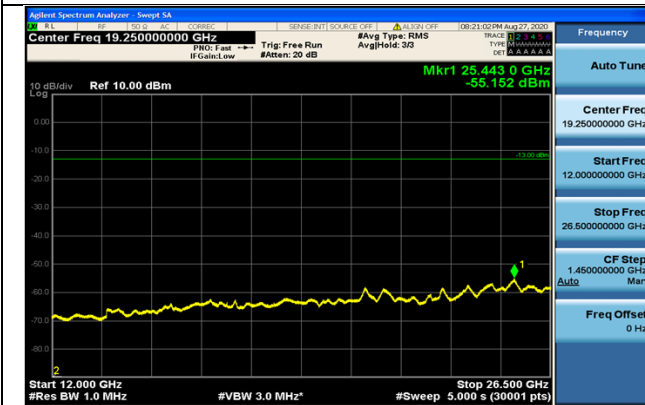

12GHz ~26.5GHz

12GHz ~26.5GHz

1RB#0

1RB#0



LTE FDD Band 5-10 MHz Channel Bandwidth High Channel

QPSK

16QAM

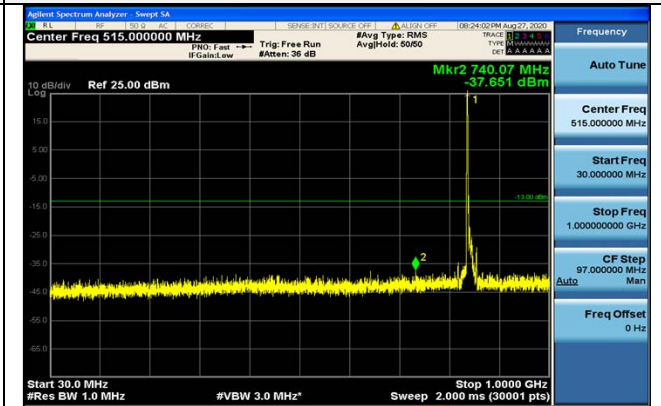
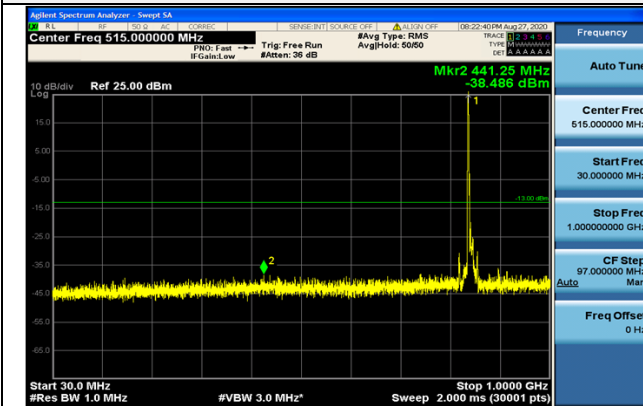

30MHz~1GHz

30MHz~1GHz



1GHz ~5GHz

1GHz ~5GHz



5GHz ~12GHz

5GHz ~12GHz

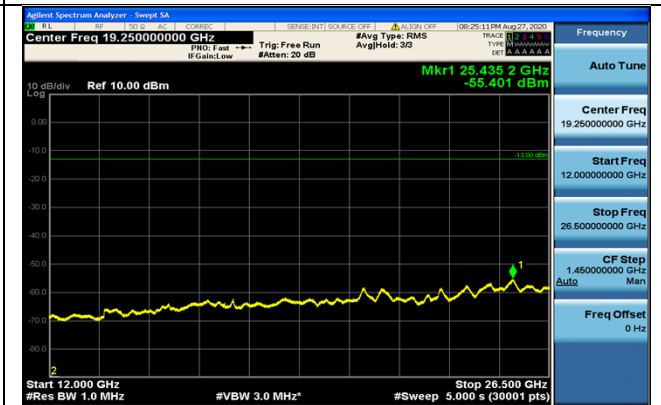

12GHz ~26.5GHz

12GHz ~26.5GHz

1RB#0

1RB#0

4.6 Radiated Spurious Emission

TEST APPLICABLE

Per FCC §24.238, the power of any emission outside of the authorized operating frequency ranges must be attenuated below the transmitting power (P) by a factor of at least $43 + 10\log(P)$ dB.

TEST CONFIGURATION

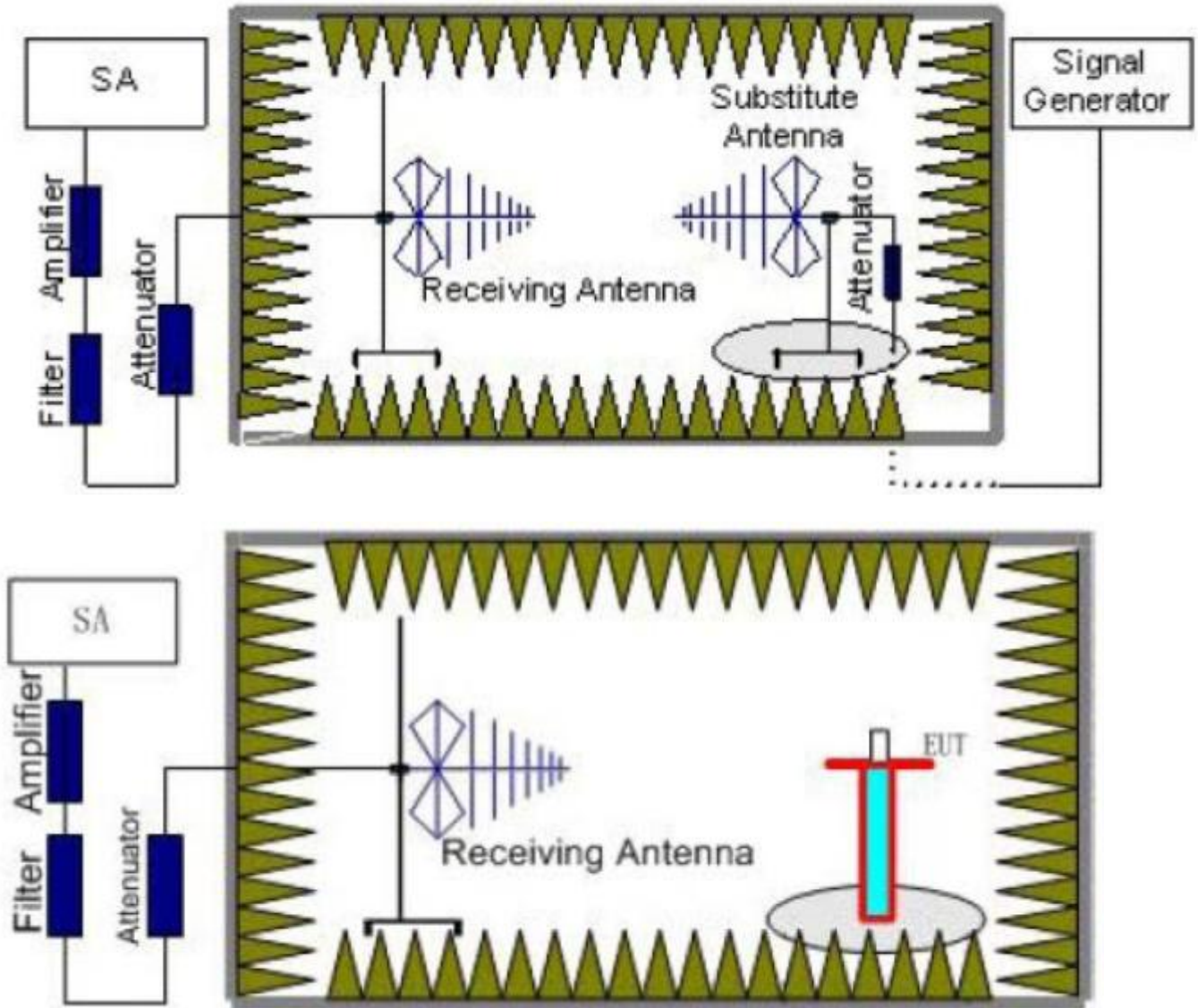

TEST PROCEDURE

1. EUT was placed on a 0.1 meter high non-conductive stand at a 3 meter test distance from the receive antenna. A receiving antenna was placed on the antenna mast 3 meters from the EUT for emission measurements. The height of receiving antenna is 0.1m. Detected emissions were maximized at each frequency by rotating the EUT through 360° and adjusting the receiving antenna polarization. The radiated emission measurements of all transmit frequencies in three channels (High, Middle, Low) were measured with peak detector.
2. A log-periodic antenna or double-ridged waveguide horn antenna shall be substituted in place of the EUT. The log-periodic antenna will be driven by a signal generator and the level will be adjusted till the same power value on the spectrum analyzer or receiver. The level of the spurious emissions can be calculated through the level of the signal generator, cable loss, the gain of the substitution antenna and the reading of the spectrum analyzer or receiver.



3. The EUT is then put into continuously transmitting mode at its maximum power level during the test. Set Test Receiver or Spectrum RBW=1MHz, VBW=3MHz, And the maximum value of the receiver should be recorded as (P_r).
4. The EUT shall be replaced by a substitution antenna. In the chamber, an substitution antenna for the frequency band of interest is placed at the reference point of the chamber. An RF Signal source for the frequency band of interest is connected to the substitution antenna with a cable that has been constructed to not interfere with the radiation pattern of the antenna. A power (P_{Mea}) is applied to the input of the substitution antenna, and adjust the level of the signal generator output until the value of the receiver reach the previously recorded (P_r). The power of signal source (P_{Mea}) is recorded. The test should be performed by rotating the test item and adjusting the receiving antenna polarization.
5. A amplifier should be connected to the Signal Source output port. And the cable should be connect between the Amplifier and the Substitution Antenna. The cable loss (P_{cl}), the Substitution Antenna Gain (G_a) and the Amplifier Gain (P_{Ag}) should be recorded after test. The measurement results are obtained as described below:
Power(EIRP)= $P_{Mea} - P_{Ag} - P_{cl} + G_a$
6. This value is EIRP since the measurement is calibrated using an antenna of known gain (2.15 dBi) and known input power.
7. ERP can be calculated from EIRP by subtracting the gain of the dipole, ERP = EIRP -2.15dBi.
8. In order to make sure test results more clearly, we set frequency range and sweep time for difference frequency range as follows table:

Working Frequency	Subrange (GHz)	RBW	VBW	Sweep time (s)
LTE BAND 5	0.03~1	100KHz	300KHz	10
	1~20	1 MHz	3 MHz	2

TEST LIMITS

According to 24.238 specify that the power of any emission outside of the authorized operating frequency ranges must be attenuated below the transmitting power (P) by a factor of at least $43 + 10 \log(P)$ dB. The specification that emissions shall be attenuated below the transmitter power (P) by at least $43 + 10 \log(P)$ dB, translates in the relevant power range (1 to 0.001 W) to -13 dBm. At 1 W the specified minimum attenuation becomes 43 dB and relative to a 30 dBm (1 W) carrier becomes a limit of -13 dBm. At 0.001 W (0 dBm) the minimum attenuation is 13 dB, which again yields a limit of -13 dBm. In this way a translation of the specification from relative to absolute terms is carried out.

Frequency	Channel	Frequency Range	Verdict
LTE BAND 5	Low	30MHz -20GHz	PASS
	Middle	30MHz -20GHz	PASS
	High	30MHz -20GHz	PASS

Radiated Measurement:

Remark:

1. We measured all RB Configuration refer 3GPP TS136 521 for each Channel Bandwidth of LTE BAND 5; recorded worst case for each Channel Bandwidth of LTE BAND 5.
2. $EIRP = P_{Mea}(dBm) - P_{cl}(dB) + G_a(dBi)$
3. Not recorded other points as values lower than limits.
4. Margin = Limit – EIRP

Remark:

1. We measured all RB Configuration refer 3GPP TS136 521 for each Channel Bandwidth of LTE FDD Band 5; recorded worst case for each Channel Bandwidth of LTE FDD Band 5.
2. $EIRP = P_{Mea}(dBm) - P_{cl}(dB) + G_a(dBi)$
3. Not recorded other points as values lower than limits.
4. Margin = Limit – EIRP

*LTE FDD Band 5_Channel Bandwidth 1.4MHz_QPSK_Low Channel*

Frequency (MHz)	P _{Mea} (dBm)	P _{cl} (dB)	Diatance	G _a Antenna Gain(dB)	Peak EIRP (dBm)	Limit (dBm)	Margin (dB)	Polarization
1649.4	-31.4	3.00	3.00	9.58	-24.82	-13	11.82	H
2474.1	-32.65	3.03	3.00	10.72	-24.96	-13	11.96	H
1649.4	-33.27	3.00	3.00	9.68	-26.59	-13	13.59	V
2474.1	-32.01	3.03	3.00	10.72	-24.32	-13	11.32	V

LTE FDD Band 5_Channel Bandwidth 1.4MHz_QPSK_Middle Channel

Frequency (MHz)	P _{Mea} (dBm)	P _{cl} (dB)	Diatance	G _a Antenna Gain(dB)	Peak EIRP (dBm)	Limit (dBm)	Margin (dB)	Polarization
1673.0	-31.73	3.00	3.00	9.58	-25.15	-13	12.15	H
2509.5	-32.15	3.03	3.00	10.72	-24.46	-13	11.46	H
1673.0	-34.02	3.00	3.00	9.68	-27.34	-13	14.34	V
2509.5	-32.58	3.03	3.00	10.72	-24.89	-13	11.89	V

LTE FDD Band 5_Channel Bandwidth 1.4MHz_QPSK_High Channel

Frequency (MHz)	P _{Mea} (dBm)	P _{cl} (dB)	Diatance	G _a Antenna Gain(dB)	Peak EIRP (dBm)	Limit (dBm)	Margin (dB)	Polarization
1696.6	-30.94	3.00	3.00	9.58	-24.36	-13	11.36	H
2544.9	-33.05	3.03	3.00	10.72	-25.36	-13	12.36	H
1696.6	-33.06	3.00	3.00	9.68	-26.38	-13	13.38	V
2544.9	-32.58	3.03	3.00	10.72	-24.89	-13	11.89	V

LTE FDD Band 5_Channel Bandwidth 3MHz_QPSK_Low Channel

Frequency (MHz)	P _{Mea} (dBm)	P _{cl} (dB)	Diatance	G _a Antenna Gain(dB)	Peak EIRP (dBm)	Limit (dBm)	Margin (dB)	Polarization
1651.0	-31.13	3.00	3.00	9.58	-24.55	-13	11.55	H
2476.5	-32.4	3.03	3.00	10.72	-24.71	-13	11.71	H
1651.0	-33.66	3.00	3.00	9.68	-26.98	-13	13.98	V
2476.5	-33.21	3.03	3.00	10.72	-25.52	-13	12.52	V

LTE FDD Band 5_Channel Bandwidth 3MHz_QPSK_Middle Channel

Frequency (MHz)	P _{Mea} (dBm)	P _{cl} (dB)	Diatance	G _a Antenna Gain(dB)	Peak EIRP (dBm)	Limit (dBm)	Margin (dB)	Polarization
1673.0	-30.42	3.00	3.00	9.58	-23.84	-13	10.84	H
2509.5	-33.36	3.03	3.00	10.72	-25.67	-13	12.67	H
1673.0	-33.84	3.00	3.00	9.68	-27.16	-13	14.16	V
2509.5	-32.32	3.03	3.00	10.72	-24.63	-13	11.63	V

LTE FDD Band 5_Channel Bandwidth 3MHz_QPSK_High Channel

Frequency (MHz)	P _{Mea} (dBm)	P _{cl} (dB)	Diatance	G _a Antenna Gain(dB)	Peak EIRP (dBm)	Limit (dBm)	Margin (dB)	Polarization
1695.0	-31.28	3.00	3.00	9.58	-24.7	-13	11.7	H
2542.5	-33.31	3.03	3.00	10.72	-25.62	-13	12.62	H
1695.0	-33.61	3.00	3.00	9.68	-26.93	-13	13.93	V
2542.5	-32.33	3.03	3.00	10.72	-24.64	-13	11.64	V

LTE FDD Band 5_Channel Bandwidth 5MHz_QPSK_Low Channel

Frequency (MHz)	P _{Mea} (dBm)	P _{cl} (dB)	Diatance	G _a Antenna Gain(dB)	Peak EIRP (dBm)	Limit (dBm)	Margin (dB)	Polarization
1653.0	-31.3	3.00	3.00	9.58	-24.72	-13	11.72	H
2479.5	-32.69	3.03	3.00	10.72	-25	-13	12	H
1653.0	-33.9	3.00	3.00	9.68	-27.22	-13	14.22	V
2479.5	-32.81	3.03	3.00	10.72	-25.12	-13	12.12	V

*LTE FDD Band 5_Channel Bandwidth 5MHz_QPSK_Middle Channel*

Frequency (MHz)	P _{Mea} (dBm)	P _{cl} (dB)	Diatance	G _a Antenna Gain(dB)	Peak EIRP (dBm)	Limit (dBm)	Margin (dB)	Polarization
1673.0	-31.14	3.00	3.00	9.58	-24.56	-13	11.56	H
2509.5	-32.57	3.03	3.00	10.72	-24.88	-13	11.88	H
1673.0	-33.46	3.00	3.00	9.68	-26.78	-13	13.78	V
2509.5	-32.04	3.03	3.00	10.72	-24.35	-13	11.35	V

LTE FDD Band 5_Channel Bandwidth 5MHz_QPSK_High Channel

Frequency (MHz)	P _{Mea} (dBm)	P _{cl} (dB)	Diatance	G _a Antenna Gain(dB)	Peak EIRP (dBm)	Limit (dBm)	Margin (dB)	Polarization
1693.0	-30.71	3.00	3.00	9.58	-24.13	-13	-30.71	H
2539.5	-35.75	3.03	3.00	10.72	-28.06	-13	-35.75	H
1693.0	-32.91	3.00	3.00	9.68	-26.23	-13	-32.91	V
2539.5	-33.63	3.03	3.00	10.72	-25.94	-13	-33.63	V

LTE FDD Band 5_Channel Bandwidth 10MHz_QPSK_Low Channel

Frequency (MHz)	P _{Mea} (dBm)	P _{cl} (dB)	Diatance	G _a Antenna Gain(dB)	Peak EIRP (dBm)	Limit (dBm)	Margin (dB)	Polarization
1658.0	-31.45	3.00	3.00	9.58	-24.87	-13	11.87	H
2487.0	-32	3.03	3.00	10.72	-24.31	-13	11.31	H
1658.0	-32.14	3.00	3.00	9.68	-25.46	-13	12.46	V
2487.0	-31.12	3.03	3.00	10.72	-23.43	-13	10.43	V

LTE FDD Band 5_Channel Bandwidth 10MHz_QPSK_Middle Channel

Frequency (MHz)	P _{Mea} (dBm)	P _{cl} (dB)	Diatance	G _a Antenna Gain(dB)	Peak EIRP (dBm)	Limit (dBm)	Margin (dB)	Polarization
1673.0	-32	3.00	3.00	9.58	-25.42	-13	12.42	H
2509.5	-31.68	3.03	3.00	10.72	-23.99	-13	10.99	H
1673.0	-32.26	3.00	3.00	9.68	-25.58	-13	12.58	V
2509.5	-30.52	3.03	3.00	10.72	-22.83	-13	9.83	V

LTE FDD Band 5_Channel Bandwidth 10MHz_QPSK_High Channel

Frequency (MHz)	P _{Mea} (dBm)	P _{cl} (dB)	Diatance	G _a Antenna Gain(dB)	Peak EIRP (dBm)	Limit (dBm)	Margin (dB)	Polarization
1688.0	-32.7	3.00	3.00	9.58	-26.12	-13	13.12	H
2532.0	-31.95	3.03	3.00	10.72	-24.26	-13	11.26	H
1688.0	-31.33	3.00	3.00	9.68	-24.65	-13	11.65	V
2532.0	-31.17	3.03	3.00	10.72	-23.48	-13	10.48	V

LTE FDD Band 5_Channel Bandwidth 1.4MHz_16QAM_Low Channel

Frequency (MHz)	P _{Mea} (dBm)	P _{cl} (dB)	Diatance	G _a Antenna Gain(dB)	Peak EIRP (dBm)	Limit (dBm)	Margin (dB)	Polarization
1649.4	-34.46	3.00	3.00	9.58	-27.88	-13	14.88	H
2474.1	-31.55	3.03	3.00	10.72	-23.86	-13	10.86	H
1649.4	-35.36	3.00	3.00	9.68	-28.68	-13	15.68	V
2474.1	-33.82	3.03	3.00	10.72	-26.13	-13	13.13	V

LTE FDD Band 5_Channel Bandwidth 1.4MHz_16QAM_Middle Channel

Frequency (MHz)	P _{Mea} (dBm)	P _{cl} (dB)	Diatance	G _a Antenna Gain(dB)	Peak EIRP (dBm)	Limit (dBm)	Margin (dB)	Polarization
1673.0	-34.83	3.00	3.00	9.58	-28.25	-13	15.25	H
2509.5	-31.84	3.03	3.00	10.72	-24.15	-13	11.15	H
1673.0	-35	3.00	3.00	9.68	-28.32	-13	15.32	V
2509.5	-33.23	3.03	3.00	10.72	-25.54	-13	12.54	V

*LTE FDD Band 5_Channel Bandwidth 1.4MHz_16QAM_High Channel*

Frequency (MHz)	P _{Mea} (dBm)	P _{cl} (dB)	Diatance	G _a Antenna Gain(dB)	Peak EIRP (dBm)	Limit (dBm)	Margin (dB)	Polarization
1696.6	-34.41	3.00	3.00	9.58	-27.83	-13	14.83	H
2544.9	-31.72	3.03	3.00	10.72	-24.03	-13	11.03	H
1696.6	-35.33	3.00	3.00	9.68	-28.65	-13	15.65	V
2544.9	-34.19	3.03	3.00	10.72	-26.5	-13	13.5	V

LTE FDD Band 5_Channel Bandwidth 3MHz_16QAM_Low Channel

Frequency (MHz)	P _{Mea} (dBm)	P _{cl} (dB)	Diatance	G _a Antenna Gain(dB)	Peak EIRP (dBm)	Limit (dBm)	Margin (dB)	Polarization
1651.0	-33.29	3.00	3.00	9.58	-26.71	-13	13.71	H
2476.5	-31.42	3.03	3.00	10.72	-23.73	-13	10.73	H
1651.0	-33.76	3.00	3.00	9.68	-27.08	-13	14.08	V
2476.5	-32.88	3.03	3.00	10.72	-25.19	-13	12.19	V

LTE FDD Band 5_Channel Bandwidth 3MHz_16QAM_Middle Channel

Frequency (MHz)	P _{Mea} (dBm)	P _{cl} (dB)	Diatance	G _a Antenna Gain(dB)	Peak EIRP (dBm)	Limit (dBm)	Margin (dB)	Polarization
1673.0	-33.67	3.00	3.00	9.58	-27.09	-13	14.09	H
2509.5	-32.5	3.03	3.00	10.72	-24.81	-13	11.81	H
1673.0	-33.98	3.00	3.00	9.68	-27.3	-13	14.3	V
2509.5	-33.75	3.03	3.00	10.72	-26.06	-13	13.06	V

LTE FDD Band 5_Channel Bandwidth 3MHz_16QAM_High Channel

Frequency (MHz)	P _{Mea} (dBm)	P _{cl} (dB)	Diatance	G _a Antenna Gain(dB)	Peak EIRP (dBm)	Limit (dBm)	Margin (dB)	Polarization
1695.0	-33.71	3.00	3.00	9.58	-27.13	-13	14.13	H
2542.5	-31.72	3.03	3.00	10.72	-24.03	-13	11.03	H
1695.0	-34.01	3.00	3.00	9.68	-27.33	-13	14.33	V
2542.5	-34.04	3.03	3.00	10.72	-26.35	-13	13.35	V

LTE FDD Band 5_Channel Bandwidth 5MHz_16QAM_Low Channel

Frequency (MHz)	P _{Mea} (dBm)	P _{cl} (dB)	Diatance	G _a Antenna Gain(dB)	Peak EIRP (dBm)	Limit (dBm)	Margin (dB)	Polarization
1653.0	-32.74	3.00	3.00	9.58	-26.16	-13	13.16	H
2479.5	-31.32	3.03	3.00	10.72	-23.63	-13	10.63	H
1653.0	-33.58	3.00	3.00	9.68	-26.9	-13	13.9	V
2479.5	-32.34	3.03	3.00	10.72	-24.65	-13	11.65	V

LTE FDD Band 5_Channel Bandwidth 5MHz_16QAM_Middle Channel

Frequency (MHz)	P _{Mea} (dBm)	P _{cl} (dB)	Diatance	G _a Antenna Gain(dB)	Peak EIRP (dBm)	Limit (dBm)	Margin (dB)	Polarization
1673.0	-33.02	3.00	3.00	9.58	-26.44	-13	13.44	H
2509.5	-31.78	3.03	3.00	10.72	-24.09	-13	11.09	H
1673.0	-32.99	3.00	3.00	9.68	-26.31	-13	13.31	V
2509.5	-33.07	3.03	3.00	10.72	-25.38	-13	12.38	V

LTE FDD Band 5_Channel Bandwidth 5MHz_16QAM_High Channel

Frequency (MHz)	P _{Mea} (dBm)	P _{cl} (dB)	Diatance	G _a Antenna Gain(dB)	Peak EIRP (dBm)	Limit (dBm)	Margin (dB)	Polarization
1693.0	-32.92	3.00	3.00	9.58	-26.34	-13	13.34	H
2539.5	-32.05	3.03	3.00	10.72	-24.36	-13	11.36	H
1693.0	-33.36	3.00	3.00	9.68	-26.68	-13	13.68	V
2539.5	-32.34	3.03	3.00	10.72	-24.65	-13	11.65	V

*LTE FDD Band 5_Channel Bandwidth 10MHz_16QAM_Low Channel*

Frequency (MHz)	P _{Mea} (dBm)	P _{cl} (dB)	Distance	G _a Antenna Gain(dB)	Peak EIRP (dBm)	Limit (dBm)	Margin (dB)	Polarization
1658.0	-30.25	3.00	3.00	9.58	-23.67	-13	10.67	H
2487.0	-31.15	3.03	3.00	10.72	-23.46	-13	10.46	H
1658.0	-32.53	3.00	3.00	9.68	-25.85	-13	12.85	V
2487.0	-30.26	3.03	3.00	10.72	-22.57	-13	9.57	V

LTE FDD Band 5_Channel Bandwidth 10MHz_16QAM_Middle Channel

Frequency (MHz)	P _{Mea} (dBm)	P _{cl} (dB)	Distance	G _a Antenna Gain(dB)	Peak EIRP (dBm)	Limit (dBm)	Margin (dB)	Polarization
1673.0	-31.01	3.00	3.00	9.58	-24.43	-13	11.43	H
2509.5	-31.86	3.03	3.00	10.72	-24.17	-13	11.17	H
1673.0	-32.05	3.00	3.00	9.68	-25.37	-13	12.37	V
2509.5	-30.57	3.03	3.00	10.72	-22.88	-13	9.88	V

LTE FDD Band 5_Channel Bandwidth 10MHz_16QAM_High Channel

Frequency (MHz)	P _{Mea} (dBm)	P _{cl} (dB)	Distance	G _a Antenna Gain(dB)	Peak EIRP (dBm)	Limit (dBm)	Margin (dB)	Polarization
1688.0	-30.58	3.00	3.00	9.58	-24	-13	11	H
2532.0	-31.68	3.03	3.00	10.72	-23.99	-13	10.99	H
1688.0	-32.1	3.00	3.00	9.68	-25.42	-13	12.42	V
2532.0	-30.31	3.03	3.00	10.72	-22.62	-13	9.62	V



4.7 Frequency Stability

LIMIT

According to §24.235, §2.1055 requirement, the frequency stability shall be sufficient to ensure that the fundamental emissions stay within the authorized bands of operation and should not exceed 2.5ppm.

TEST CONFIGURATION

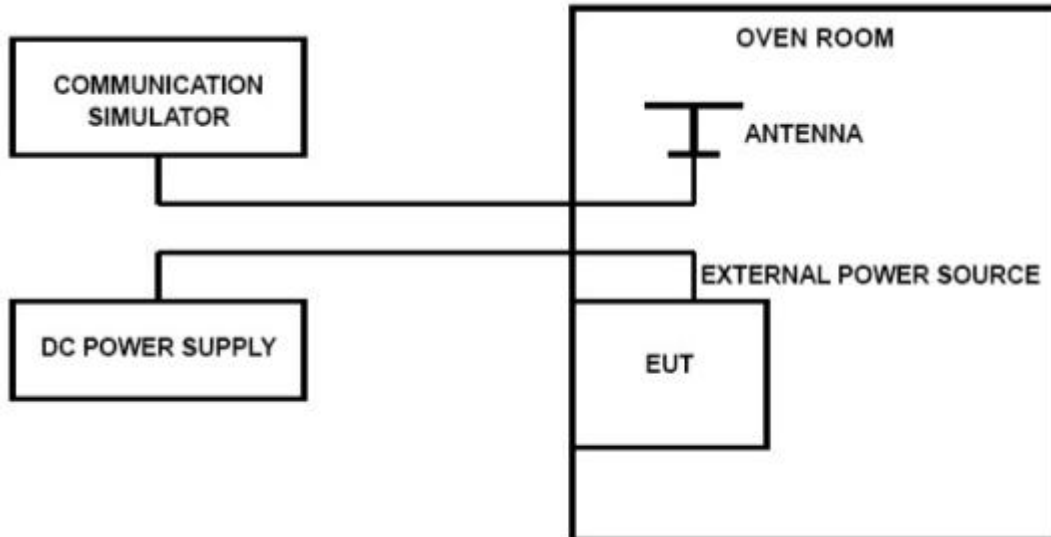

TEST PROCEDURE

The EUT was setup according to EIA/TIA 603D

Frequency Stability Under Temperature Variations:

In order to measure the carrier frequency under the condition of AFC lock, it is necessary to make measurements with the EUT in a “call mode”. This is accomplished with the use of R&S CMW500 DIGITAL RADIO COMMUNICATION TESTER.

1. Measure the carrier frequency at room temperature.
2. Subject the EUT to overnight soak at -30°C.
3. With the EUT, powered via nominal voltage, connected to the CMW500 and in a simulated call on middle channel for LTE Band 5, measure the carrier frequency. These measurements should be made within 2 minutes of Powering up the EUT, to prevent significant self-warming.
4. Repeat the above measurements at 10°C increments from -30°C to +50°C. Allow at least 1.5 hours at each temperature, unpowered, before making measurements.
5. Re-measure carrier frequency at room temperature with nominal voltage. Vary supply voltage from minimum voltage to maximum voltage, in 0.1Volt increments re-measuring carrier frequency at each voltage. Pause at nominal voltage for 1.5 hours unpowered, to allow any self-heating to stabilize, before continuing.
6. Subject the EUT to overnight soak at +50°C.
7. With the EUT, powered via nominal voltage, connected to the CMW500 and in a simulated call on the centre channel, measure the carrier frequency. These measurements should be made within 2 minutes of Powering up the EUT, to prevent significant self-warming.
8. Repeat the above measurements at 10 °C increments from +50°C to -30°C. Allow at least 1.5 hours at each temperature, unpowered, before making measurements
9. At all temperature levels hold the temperature to +/- 0.5°C during the measurement procedure.

Frequency Stability Under Voltage Variations:

Set chamber temperature to 20°C. Use a variable AC power supply / DC power source to power the EUT and set the voltage to rated voltage. Set the spectrum analyzer RBW low enough to obtain the desired frequency resolution and recorded the frequency.

Reduce the input voltage to specify extreme voltage variation (±15%) and endpoint, record the maximum frequency change.

TEST RESULTS

Remark:



1. We tested all RB Configuration refer 3GPP TS136 521 for each Channel Bandwidth of LTE FDD Band 5; recorded worst case.

LTE Band 5, 1.4MHz bandwidth , QPSK (worst case of all bandwidths)

LTE FDD Band 5					
DC Power	Temperature (°C)	Frequency error(Hz)	Frequency error(ppm)	Limit (ppm)	Verdict
3.27V	20	-8.33	-0.010101	2.50	PASS
3.85V	20	-7.78	-0.009434	2.50	PASS
4.43V	20	-7.40	-0.008973	2.50	PASS
3.85V	-30	-7.28	-0.008827	2.50	PASS
3.85V	-20	-8.77	-0.010634	2.50	PASS
3.85V	-10	-8.83	-0.010556	2.50	PASS
3.85V	0	-10.33	-0.012349	2.50	PASS
3.85V	10	-6.54	-0.007818	2.50	PASS
3.85V	20	-6.17	-0.007376	2.50	PASS
3.85V	30	-12.86	-0.015374	2.50	PASS
3.85V	40	-11.69	-0.013781	2.50	PASS
3.85V	50	-8.27	-0.009749	2.50	PASS



LTE Band 5, 1.4MHz bandwidth , 16QAM (worst case of all bandwidths)

<i>LTE FDD Band 5</i>					
DC Power	Temperature (°C)	Frequency error(Hz)	Frequency error(ppm)	Limit (ppm)	Verdict
3.27V	20	-11.93	-0.014466	2.50	PASS
3.85V	20	-17.92	-0.021729	2.50	PASS
4.43V	20	-13.45	-0.016309	2.50	PASS
3.85V	-30	-10.59	-0.012841	2.50	PASS
3.85V	-20	-9.88	-0.011980	2.50	PASS
3.85V	-10	-6.88	-0.008225	2.50	PASS
3.85V	0	-9.16	-0.010950	2.50	PASS
3.85V	10	-12.85	-0.015362	2.50	PASS
3.85V	20	-10.04	-0.012002	2.50	PASS
3.85V	30	-8.11	-0.009695	2.50	PASS
3.85V	40	-14.92	-0.017588	2.50	PASS
3.85V	50	-14.88	-0.017541	2.50	PASS

5 Test Setup Photos of the EUT

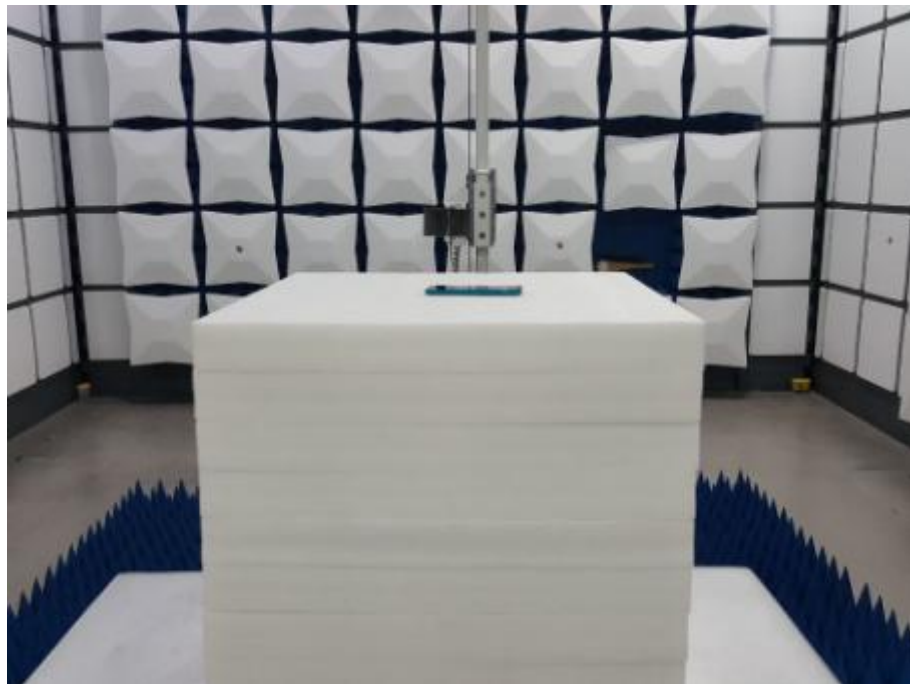
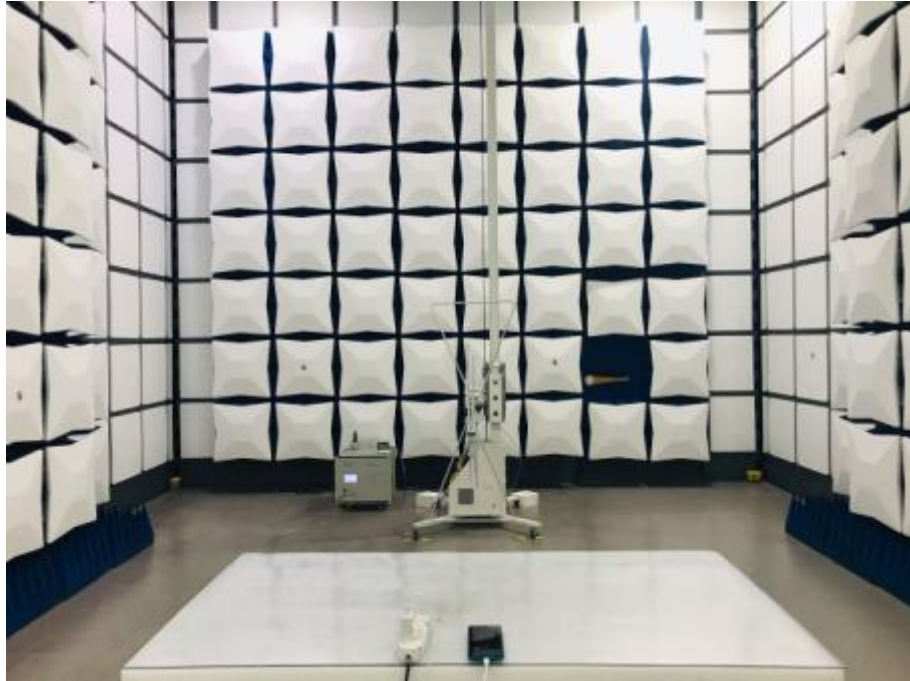

*****End of Report*****