



**FCC PART 22/24 TEST REPORT**  
**FCC Part 22 /Part 24**

Report Reference No.: HK2008282384-6E  
FCC ID: **2ARTXLE000Z93P**  
Compiled by  
( position+printed name+signature)..: File administrators Gary Qian

Supervised by  
( position+printed name+signature)..: Technique principal Eden Hu

Approved by  
( position+printed name+signature)..: Manager Jason Zhou

Date of issue.....: Sep. 02, 2020

**Testing Laboratory Name** .....: **Shenzhen HUAKE Testing Technology Co., Ltd.**  
Address.....: 1F, B2 Building, Junfeng Zhongcheng Zhizao Innovation Park,  
Heping Community, Fuhai Street, Bao'an District, Shenzhen, China

**Applicant's name** .....: **LAVA International Limited**  
Address.....: A-56, Sector 64, Noida 201301, U.P., India

**Test specification** .....:  
Standard .....: **FCC Part 22: PUBLIC MOBILE SERVICES**  
**FCC Part 24: PERSONAL COMMUNICATIONS SERVICES**

**Shenzhen HUAKE Testing Technology Co., Ltd. All rights reserved.**

This publication may be reproduced in whole or in part for non-commercial purposes as long as the Shenzhen HUAKE Testing Technology Co., Ltd. is acknowledged as copyright owner and source of the material. Shenzhen HUAKE Testing Technology Co., Ltd. takes no responsibility for and will not assume liability for damages resulting from the reader's interpretation of the reproduced material due to its placement and context.

**Test item description** .....: Mobile Phone  
Trade Mark .....: LAVA  
Model/Type reference.....: LE000Z93P  
Listed Models .....: N/A  
Ratings.....: DC 3.85V from battery or DC 5V from adapter  
Modulation .....: GMSK/8PSK  
GPRS.....: Supported  
Hardware version .....: V2.0  
Software version .....: V2.0  
Frequency.....: GSM 850MHz; PCS 1900MHz;  
Result.....: **PASS**

**TEST REPORT**

<b>Test Report No. :</b>	<b>HK2008282384-6E</b>	Sep. 02, 2020
		Date of issue

Equipment under Test : Mobile Phone

Model /Type : LE000Z93P

Listed Models : N/A

**Applicant** : LAVA International Limited

Address : A-56, Sector 64, Noida 201301, U.P., India

**Manufacturer** : LAVA International Limited

Address : A-56, Sector 64, Noida 201301, U.P., India

<b>Test Result:</b>	<b>PASS</b>
---------------------	-------------

The test report merely corresponds to the test sample.  
It is not permitted to copy extracts of these test result without the written permission of the test laboratory.



## Revision History

Revision	Issue Date	Revisions	Revised By
V1.0	Sep. 02, 2020	Initial Issue	Jason Zhou



## Contents

<b><u>1</u></b>	<b><u>TEST STANDARDS.....</u></b>	<b><u>5</u></b>
<b><u>2</u></b>	<b><u>SUMMARY .....</u></b>	<b><u>6</u></b>
2.1	General Remarks	6
2.2	Product Description	6
2.3	Equipment under Test	6
2.4	Short description of the Equipment under Test (EUT)	7
2.5	EUT configuration	7
2.6	Related Submittal(s) / Grant (s)	7
2.7	Modifications	7
2.8	General Test Conditions/Configurations	7
2.9	Modifications	7
<b><u>3</u></b>	<b><u>TEST ENVIRONMENT.....</u></b>	<b><u>8</u></b>
3.1	Address of the test laboratory	8
3.2	Environmental conditions	8
3.3	Test Description	8
3.4	Equipments Used during the Test	10
<b><u>4</u></b>	<b><u>TEST CONDITIONS AND RESULTS.....</u></b>	<b><u>11</u></b>
4.1	Output Power	11
4.2	Radiated Spurious Emission	16
4.3	Occupied Bandwidth and Emission Bandwidth	21
4.4	Band Edge Compliance	26
4.5	Spurious Emission on Antenna Port	31
4.6	Frequency Stability Test	40
4.7	Peak-to-Average Ratio (PAR)	44
<b><u>5</u></b>	<b><u>TEST SETUP PHOTOS OF THE EUT .....</u></b>	<b><u>46</u></b>



## **1 TEST STANDARDS**

The tests were performed according to following standards:

[FCC Part 2](#): FREQUENCY ALLOCATIONS AND RADIO TREATY MATTERS; GENERAL RULES AND REGULATIONS

[FCC Part 22 Subpart H](#): PRIVATE LAND MOBILE RADIO SERVICES.

[FCC Part 24 Subpart E](#): PUBLIC MOBILE SERVICES

[ANSI/TIA-603-E-2016](#): Land Mobile FM or PM Communications Equipment Measurement and Performance Standards.

[ANSI C63.26-2015](#): IEEE/ANSI Standard for Compliance Testing of Transmitters Used in Licensed Radio Services

[FCC KDB 971168D01 v03r01](#) Power Meas License Digital Systems



## 2 SUMMARY

### 2.1 General Remarks

Date of receipt of test sample	:	Aug. 27, 2020
Testing commenced on	:	Aug. 27, 2020
Testing concluded on	:	Sep. 02, 2020

### 2.2 Product Description

Product Name:	Mobile Phone
Model/Type reference:	LE000Z93P
List Model:	N/A
Power supply:	DC 3.85V from battery or DC 5V from adapter
Adapter Information	Input: 100-240V, 50/60Hz, 0.35A; Output:5V, 2000mA
Modulation Type	GMSK/8PSK
Antenna Type	Internal antenna
GSM/EDGE/GPRS	Supported EGPRS/GPRS/GSM
GSM/GPRS Power Class	GSM850:Power Class 4/ PCS1900:Power Class 1
GSM/GPRS Operation Frequency	GSM850 :824.2MHz-848.8MHz/PCS1900:1850.2MHz-1909.8MHz
GPRS Operation Frequency Band	GPRS850/GPRS1900
GPRS/EDGE Multislot Class	EGPRS/GPRS: Multi-slot Class 12
EGPRS Multislot Class	/
Extreme temp. Tolerance	-30°C to +50°C
GPRS operation mode	Class B

### 2.3 Equipment under Test

#### Power supply system utilised

Power supply voltage	:	<input type="radio"/> 120V / 60 Hz	<input type="radio"/> 230V / 50Hz
		<input type="radio"/> 12 V DC	<input type="radio"/> 24 V DC
		<input checked="" type="radio"/> Other (specified in blank below)	

DC 3.85V from battery or DC 5V from adapter

#### Test frequency list

Test Mode	TX/RX	RF Channel		
		Low(L)	Middle (M)	High (H)
GSM850	TX	Channel 128	Channel 190	Channel 251
		824.2 MHz	836.6 MHz	848.8 MHz
	RX	Channel 128	Channel 190	Channel 251
		869.2 MHz	881.6 MHz	893.8 MHz
Test Mode	TX/RX	RF Channel		
		Low(L)	Middle (M)	High (H)
GSM1900	TX	Channel 512	Channel 661	Channel 810
		1850.2 MHz	1880.0 MHz	1909.8 MHz
	RX	Channel 512	Channel 661	Channel 810
		1930.2 MHz	1960.0 MHz	1989.8 MHz



## 2.4 Short description of the Equipment under Test (EUT)

This is a Mobile Phone.

For more details, refer to the user's manual of the EUT.

## 2.5 EUT configuration

The following peripheral devices and interface cables were connected during the measurement:

- supplied by the manufacturer
- supplied by the lab

<input type="radio"/>	/	M/N :	/
		Manufacturer:	/

## 2.6 Related Submittal(s) / Grant (s)

This submittal(s) (test report) is intended for **FCC ID: 2ARTXLE000Z93P** filing to comply with FCC Part 22 and Part 24 Rules

## 2.7 Modifications

No modifications were implemented to meet testing criteria.

## 2.8 General Test Conditions/Configurations

### 2.8.1 Test Modes

NOTE: The test mode(s) are selected according to relevant radio technology specifications.

Test Mode 1	GPRS
Test Mode 2	GSM
Test Mode 3	EGPRS

### 2.8.2 Test Environment

Environment Parameter	Selected Values During Tests	
Relative Humidity	Ambient	
Temperature	TN	Ambient
Voltage	VL	3.27V
	VN	3.85V
	VH	4.43V

NOTE: VL=lower extreme test voltage VN=nominal voltage  
VH=upper extreme test voltage TN=normal temperature

## 2.9 Modifications

No modifications were implemented to meet testing criteria.



### 3 TEST ENVIRONMENT

#### 3.1 Address of the test laboratory

Shenzhen HUAKE Testing Technology Co., Ltd.  
Add.:1F, B2 Building, Junfeng Zhongcheng Zhizao Innovation Park,Heping Community, Fuhai Street,  
Bao'an District, Shenzhen, China

#### 3.2 Environmental conditions

During the measurement the environmental conditions were within the listed ranges:

Temperature:	15-35 ° C
Humidity:	30-60 %
Atmospheric pressure:	950-1050mbar

#### 3.3 Test Description

##### 3.3.1 Cellular Band (824-849MHz paired with 869-894MHz)

Test Item	FCC Rule No.	Requirements	Verdict
Effective(Isotropic) Radiated Output Power	§2.1046, §22.913	FCC: ERP ≤ 7W.	Pass
Modulation Characteristics	§2.1047	Digital modulation	N/A
Bandwidth	§2.1049	OBW: No limit. EBW: No limit.	Pass
Band Edges Compliance	§2.1051, §22.917	≤-13dBm/1%*EBW, in 1MHz bands immediately outside and adjacent to The frequency block.	Pass
Spurious Emission at Antenna Terminals	§2.1051, §22.917	FCC: ≤ -13dBm/100kHz, from 9kHz to 10th harmonics but outside authorized operating frequency ranges.	Pass
Field Strength of Spurious Radiation	§2.1053, §22.917	FCC: ≤ -13dBm/100kHz.	Pass
Frequency Stability	§2.1055, §22.355	≤ ±2.5ppm.	Pass

NOTE 1: For the verdict, the "N/A" denotes "not applicable", the "N/T" de notes "not tested".



**3.3.2 PCS Band (1850-1915MHz paired with 1930-1995MHz)**

Test Item	FCC Rule No.	Requirements	Verdict
Effective(Isotropic) Radiated Output Power	§2.1046, §24.232	EIRP $\leq$ 2W	Pass
Peak-Average Ratio	§2.1046, §24.232	FCC:Limit $\leq$ 13dB	Pass
Modulation Characteristics	§2.1047	Digital modulation	Pass
Bandwidth	§2.1049	OBW: No limit. EBW: No limit.	Pass
Band Edges Compliance	§2.1051, §24.238	$\leq$ -13dBm/1%*EBW, In 1MHz bands immediately outside and adjacent to The frequency block.	Pass
Spurious Emission at Antenna Terminals	§2.1051, §24.238	$\leq$ -13dBm/1MHz, from 9kHz to10th harmonics but outside authorized Operating frequency ranges.	Pass
Field Strength of Spurious Radiation	§2.1053, §24.238	$\leq$ -13dBm/1MHz.	Pass
Frequency Stability	§2.1055, §24.235	FCC: within authorized frequency block.	Pass

NOTE 1: For the verdict, the "N/A" denotes "not applicable", the "N/T" de notes "not tested".

## Remark:

1. The measurement uncertainty is not included in the test result.



### 3.4 Equipments Used during the Test

Test Equipment	Manufacturer	Model No.	Serial No.	Calibration Date	Calibration Due Date
LISN	R&S	ENV216	HKE-059	2019/12/26	2020/12/25
LISN	R&S	ENV216	HKE-002	2019/12/26	2020/12/25
Receiver	R&S	ESCI 7	HKE-010	2019/12/26	2020/12/25
Spectrum analyzer	R&S	FSP40	HKE-025	2019/12/26	2020/12/25
Spectrum analyzer	Agilent	N9020A	HKE-048	2019/12/26	2020/12/25
RF automatic control unit	Tonscend	JS0806-1	HKE-060	2019/12/26	2020/12/25
Loop antenna	Schwarzbeck	FMZB 1519 B	HKE-014	2019/12/26	2020/12/25
Bilog Broadband Antenna	Schwarzbeck	VULB9163	HKE-012	2019/12/26	2020/12/25
Horn antenna	Schwarzbeck	9120D	HKE-013	2019/12/26	2020/12/25
High gain antenna	Schwarzbeck	LB-180400KF	HKE-054	2019/12/26	2020/12/25
Preamplifier	EMCI	EMC051845SE	HKE-015	2019/12/26	2020/12/25
Preamplifier	Agilent	83051A	HKE-016	2019/12/26	2020/12/25
Preamplifier	Schwarzbeck	BBV 9743	HKE-006	2019/12/26	2020/12/25
Temperature and humidity meter	Boyang	HTC-1	HKE-075	2019/12/26	2020/12/25
High-low temperature chamber	Guangke	HT-80L	HKE-118	2019/12/26	2020/12/25
High pass filter unit	Tonscend	JS0806-F	HKE-055	2019/12/26	2020/12/25
RF Cable(below1GHz)	Times	9kHz-1GHz	HKE-117	2019/12/26	2020/12/25
RF Cable(above 1GHz)	Times	1-40G	HKE-034	2019/12/26	2020/12/25
Power meter	Agilent	E4419B	HKE-085	2019/12/26	2020/12/25
Power Sensor	Agilent	E9300A	HKE-086	2019/12/26	2020/12/25
Conducted test software	Tonscend	TS+ Rev 2.5.0.0	HKE-081	N/A	N/A
Radiated test software	Tonscend	TS+ Rev 2.5.0.0	HKE-082	N/A	N/A
RF test software	Tonscend	JS1120-B Version 2.6	HKE-083	N/A	N/A
RF test software	Tonscend	JS1120-4	HKE-113	N/A	N/A
RF test software	Tonscend	JS1120-3	HKE-114	N/A	N/A
RF test software	Tonscend	JS1120-1	HKE-115	N/A	N/A
Wireless Communication Test Set	R&S	CMW500	HKE-026	2019/12/26	2020/12/25
Wireless Communication Test Set	R&S	CMU200	HKE-029	2019/12/26	2020/12/25

## 4 TEST CONDITIONS AND RESULTS

### 4.1 Output Power

#### TEST APPLICABLE

During the process of testing, the EUT was controlled via R&S Digital Radio Communication tester (CMW500) to ensure max power transmission and proper modulation. This result contains output power and EIRP measurements for the EUT. In all cases, output power is within the specified limits.

#### 4.1.1 Conducted Output Power

##### TEST CONFIGURATION

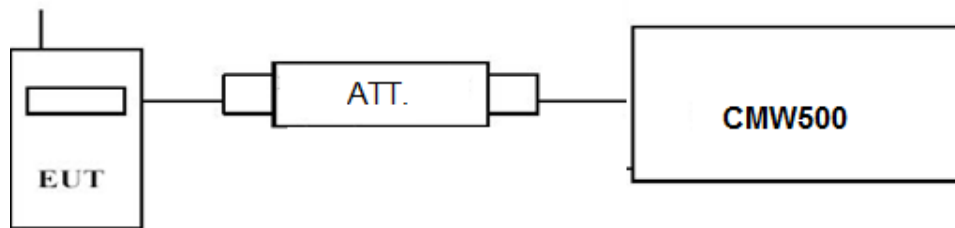

##### TEST PROCEDURE

###### Conducted Power Measurement:

- Place the EUT on a bench and set it in transmitting mode.
- Connect a low loss RF cable from the antenna port to a CMW500 by an Att.
- EUT Communicate with CMW500 then selects a channel for testing.
- Add a correction factor to the display CMW500, and then test.

GSM850				
Function	Power step	Nominal output power (dBm)	Power & Multislot class	Operation class
GSM	5	33dBm(2W)	4	/
GPRS	3	33dBm(2W)	12	B
EDGE	8	27dBm(0.5W)	12	B

PCS1900				
Function	Power step	Nominal output power (dBm)	Power & Multislot class	Operation class
GSM	0	30dBm(1W)	1	/
GPRS	3	30dBm(1W)	12	B
EDGE	5	27dBm(0.5W)	12	B



**TEST RESULTS**

<b>GSM 850</b>		<b>Burst Average Conducted power (dBm)</b>		
		<b>Channel/Frequency(MHz)</b>		
		<b>128/824.2</b>	<b>190/836.6</b>	<b>251/848.8</b>
GSM		30.42	30.45	30.32
GPRS (GMSK)	1TX slot	30.62	30.60	30.44
	2TX slot	29.83	29.81	29.61
	3TX slot	28.03	27.99	27.8
	4TX slot	26.87	26.86	26.65
EGPRS (8PSK)	1TX slot	28.41	28.09	27.82
	2TX slot	26.81	26.54	26.37
	3TX slot	24.40	24.20	23.93
	4TX slot	23.10	22.99	22.56
<b>GSM 1900</b>		<b>Burst Average Conducted power (dBm)</b>		
		<b>Channel/Frequency(MHz)</b>		
		<b>512/1850.2</b>	<b>661/1880.0</b>	<b>810/1909.8</b>
GSM		32.04	31.95	31.88
GPRS (GMSK)	1TX slot	32.24	32.05	31.44
	2TX slot	30.10	29.99	30.30
	3TX slot	28.98	28.86	28.97
	4TX slot	27.84	27.77	27.86
EGPRS (8PSK)	1TX slot	31.03	30.69	30.48
	2TX slot	29.92	29.59	29.63
	3TX slot	27.95	27.77	27.71
	4TX slot	26.87	26.53	26.65

## 4.1.2 Radiated Output Power

### TEST DESCRIPTION

This is the test for the maximum radiated power from the EUT.

Rule Part 24.232(c) specifies, "Mobile/portable stations are limited to 2 watts e.i.r.p. Peak power" and 24.232(e) specifies that "Peak transmit power must be measured over any interval of continuous transmission using instrumentation calibrated in terms of an rms-equivalent voltage." Rule Part 22.913(a) specifies "The ERP of mobile transmitters and auxiliary test transmitters must not exceed 7 Watts."

### TEST CONFIGURATION

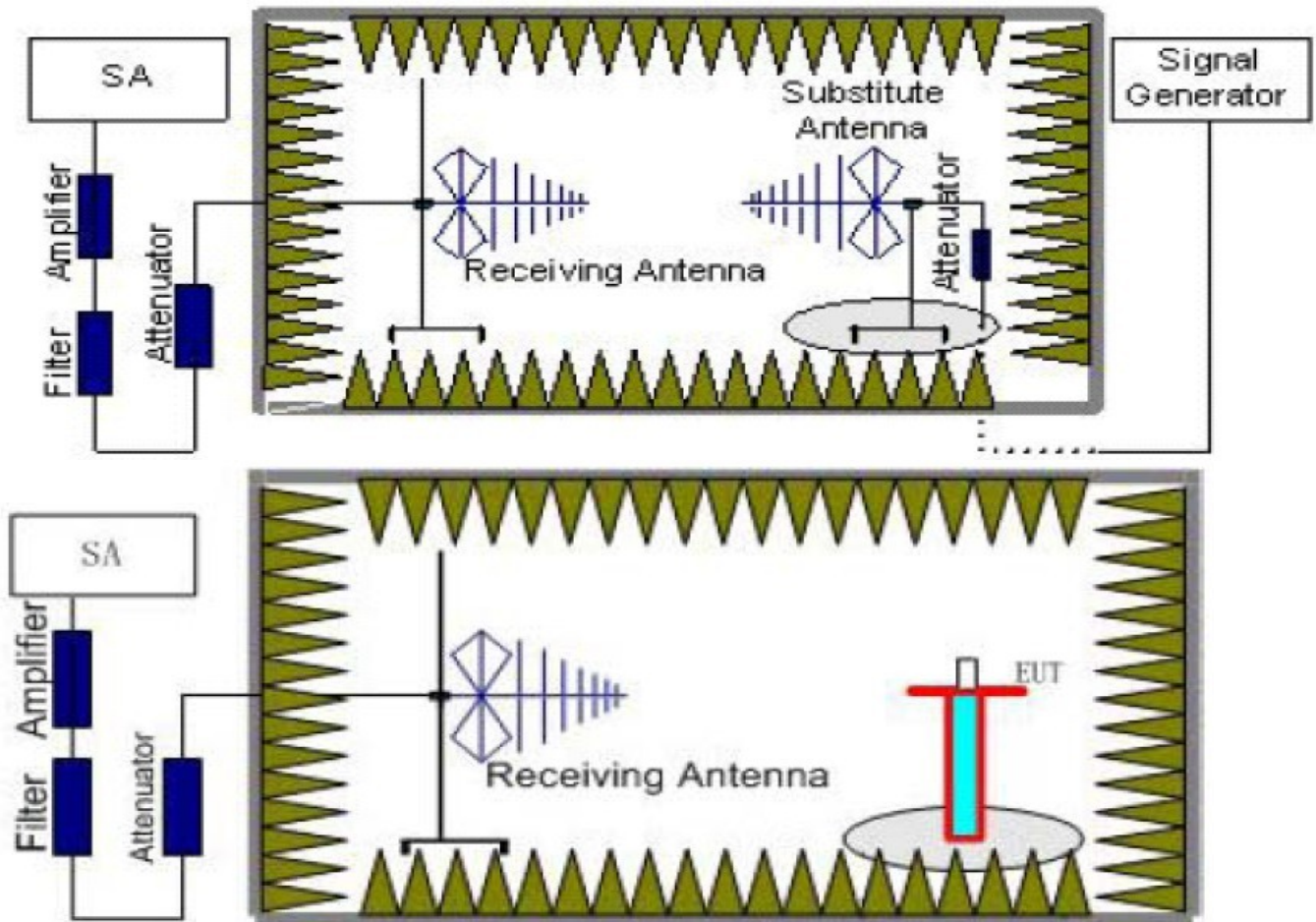

### TEST PROCEDURE

1. EUT was placed on a 0.80 meter high non-conductive stand at a 3 meter test distance from the receive antenna. A receiving antenna was placed on the antenna mast 3 meters from the EUT for emission measurements. The height of receiving antenna is 0.80m. Detected emissions were maximized at each frequency by rotating the EUT through 360° and adjusting the receiving antenna polarization. The radiated emission measurements of all transmit frequencies in three channels (High, Middle, Low) were measured with peak detector.
2. A log-periodic antenna or double-ridged waveguide horn antenna shall be substituted in place of the EUT. The log-periodic antenna will be driven by a signal generator and the level will be adjusted till the same power value on the spectrum analyzer or receiver. The level of the spurious emissions can be calculated through the level of the signal generator, cable loss, the gain of the substitution antenna and the reading of the spectrum analyzer or receiver.
3. The EUT is then put into continuously transmitting mode at its maximum power level during the test. Set Test Receiver or Spectrum RBW=1MHz, VBW=3MHz, And the maximum value of the receiver should be recorded as (P<sub>r</sub>).
4. The EUT shall be replaced by a substitution antenna. In the chamber, an substitution antenna for the frequency band of interest is placed at the reference point of the chamber. An RF Signal source for the frequency band of interest is connected to the substitution antenna with a cable that has been constructed



to not interfere with the radiation pattern of the antenna. A power ( $P_{Mea}$ ) is applied to the input of the substitution antenna, and adjust the level of the signal generator output until the value of the receiver reach the previously recorded ( $P_r$ ). The power of signal source ( $P_{Mea}$ ) is recorded. The test should be performed by rotating the test item and adjusting the receiving antenna polarization.

5. A amplifier should be connected to the Signal Source output port. And the cable should be connect between the Amplifier and the Substitution Antenna. The cable loss ( $P_{cl}$ ), the Substitution Antenna Gain ( $G_a$ ) and the Amplifier Gain ( $P_{Ag}$ ) should be recorded after test.

The measurement results are obtained as described below:

$$\text{Power(EIRP)} = P_{Mea} - P_{Ag} - P_{cl} + G_a$$

We used SMF100A micowave signal generator which signal level can up to 33dBm,so we not used power Amplifier for substitution test; The measurement results are amend as described below:

$$\text{Power(EIRP)} = P_{Mea} - P_{cl} + G_a$$

6. This value is EIRP since the measurement is calibrated using an antenna of known gain (2.15 dBi) and known input power.
7. ERP can be calculated from EIRP by subtracting the gain of the dipole,  $ERP = EIRP - 2.15\text{dBi}$ .

**TEST LIMIT**

Note: We test the H direction and V direction, V direction is worse.

According to 22.913(a) and 24.232(c), the ERP should be not exceed following table limits:

GSM850(GPRS850,EDGE850)		
Function	Power Step	Burst Peak ERP (dBm)
GSM	5	≤38.45dBm (7W)
GPRS	3	≤38.45dBm (7W)
EDGE	8	≤38.45dBm (7W)

PCS1900(GPRS1900,EDGE1900)		
Function	Power Step	Burst Peak EIRP (dBm)
GSM	0	≤33dBm (2W)
GPRS	3	≤33dBm (2W)
EDGE	5	≤33dBm (2W)

**TEST RESULTS**

Remark:

1. We were tested all Configuration refer 3GPP TS151 010.
2.  $EIRP = P_{Mea}(\text{dBm}) - P_{cl}(\text{dB}) + P_{Ag}(\text{dB}) + G_a(\text{dBi})$
3.  $ERP = EIRP - 2.15\text{dBi}$  as EIRP by subtracting the gain of the dipole.

Note: 1.We tesed Horizontal and Vertical,and Recorded the worst data at the Vertical

**GSM 850**

Frequency (MHz)	$P_{Mea}$ (dBm)	$P_{cl}$ (dB)	$G_a$ Antenna Gain(dB)	Correction (dB)	$P_{Ag}$ (dB)	ERP (dBm)	Limit (dBm)	Margin (dB)	Polarization
824.20	-14.03	2.42	8.45	2.15	36.82	26.67	38.45	11.78	V
836.60	-15.6	2.46	8.45	2.15	36.82	25.06	38.45	13.39	V
848.80	-13.18	2.53	8.36	2.15	36.82	27.32	38.45	11.13	V

**GSM 1900**

Frequency (MHz)	$P_{Mea}$ (dBm)	$P_{cl}$ (dB)	$G_a$ Antenna Gain(dB)	$P_{Ag}$ (dB)	EIRP (dBm)	Limit (dBm)	Margin (dB)	Polarization
1850.20	-13.24	3.41	10.24	33.6	27.19	33.01	5.82	V
1880.00	-13.22	3.49	10.24	33.6	27.13	33.01	5.88	V
1909.80	-13.51	3.55	10.23	33.6	26.77	33.01	6.24	V



## GPRS 850

Frequency (MHz)	P <sub>Mea</sub> (dBm)	P <sub>cl</sub> (dB)	G <sub>a</sub> Antenna Gain(dB)	Correction (dB)	P <sub>Ag</sub> (dB)	ERP (dBm)	Limit (dBm)	Margin (dB)	Polarization
824.20	-14.31	2.42	8.45	2.15	36.82	26.39	38.45	12.06	V
836.60	-15.81	2.46	8.45	2.15	36.82	24.85	38.45	13.6	V
848.80	-13.79	2.53	8.36	2.15	36.82	26.71	38.45	11.74	V

## GPRS 1900

Frequency (MHz)	P <sub>Mea</sub> (dBm)	P <sub>cl</sub> (dB)	G <sub>a</sub> Antenna Gain(dB)	P <sub>Ag</sub> (dB)	EIRP (dBm)	Limit (dBm)	Margin (dB)	Polarization
1850.20	-14.16	3.41	10.24	33.6	26.27	33.01	6.74	V
1880.00	-14.56	3.49	10.24	33.6	25.79	33.01	7.22	V
1909.80	-14.94	3.55	10.23	33.6	25.34	33.01	7.67	V

## EGPRS 850

Frequency (MHz)	P <sub>Mea</sub> (dBm)	P <sub>cl</sub> (dB)	G <sub>a</sub> Antenna Gain(dB)	Correction (dB)	P <sub>Ag</sub> (dB)	ERP (dBm)	Limit (dBm)	Margin (dB)	Polarization
824.20	-14.23	2.42	8.45	2.15	36.82	26.47	38.45	11.98	V
836.60	-15.16	2.46	8.45	2.15	36.82	25.5	38.45	12.95	V
848.80	-13.56	2.53	8.36	2.15	36.82	26.94	38.45	11.51	V

## EGPRS 1900

Frequency (MHz)	P <sub>Mea</sub> (dBm)	P <sub>cl</sub> (dB)	G <sub>a</sub> Antenna Gain(dB)	P <sub>Ag</sub> (dB)	EIRP (dBm)	Limit (dBm)	Margin (dB)	Polarization
1850.20	-14.09	3.41	10.24	33.6	26.34	33.01	6.67	V
1880.00	-14.16	3.49	10.24	33.6	26.19	33.01	6.82	V
1909.80	-14.83	3.55	10.23	33.6	25.45	33.01	7.56	V

## 4.2 Radiated Spurious Emission

### TEST APPLICABLE

According to the TIA/EIA 603D:2010 test method, The Receiver or Spectrum was scanned from 30 MHz to the 10th harmonic of the highest frequency generated within the equipment, which is the transmitted carrier that can be as high as 1910 MHz. The resolution bandwidth is set as outlined in Part 24.238 and Part 22.917. The spectrum is scanned with the mobile station transmitting at carrier frequencies that pertain to low, mid and high channels of PCS1900 and GSM850.

### TEST CONFIGURATION

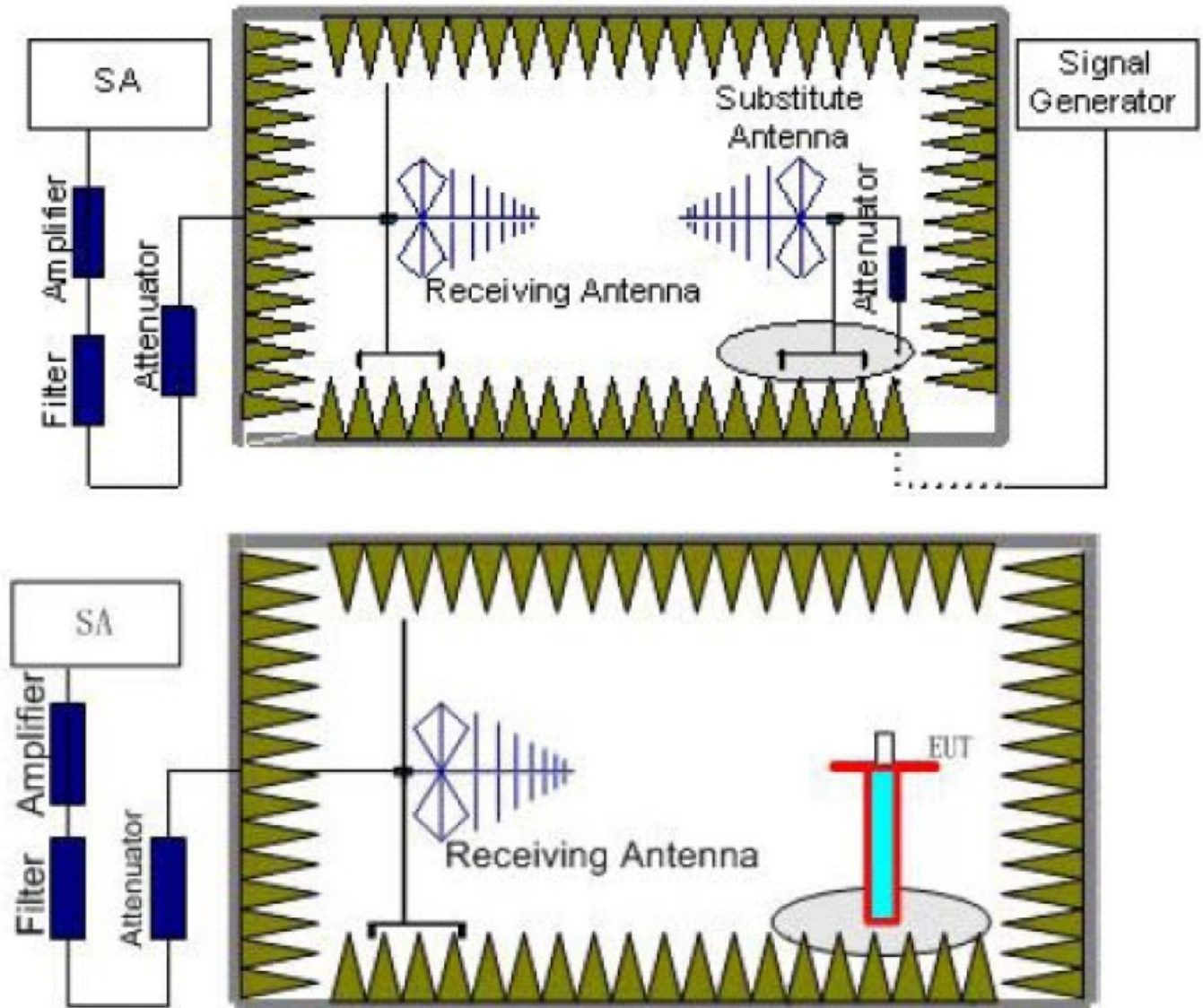

### TEST PROCEDURE

1. EUT was placed on a 0.80 meter high non-conductive stand at a 3 meter test distance from the receive antenna. A receiving antenna was placed on the antenna mast 3 meters from the EUT for emission measurements. The height of receiving antenna is 0.80m. Detected emissions were maximized at each frequency by rotating the EUT through 360° and adjusting the receiving antenna polarization. The radiated emission measurements of all transmit frequencies in three channels (High, Middle, Low) were measured with peak detector.
2. A log-periodic antenna or double-ridged waveguide horn antenna shall be substituted in place of the EUT. The log-periodic antenna will be driven by a signal generator and the level will be adjusted till the same power value on the spectrum analyzer or receiver. The level of the spurious emissions can be calculated





through the level of the signal generator, cable loss, the gain of the substitution antenna and the reading of the spectrum analyzer or receiver.

3. The EUT is then put into continuously transmitting mode at its maximum power level during the test. Set Test Receiver or Spectrum RBW=1MHz,VBW=3MHz, And the maximum value of the receiver should be recorded as ( $P_r$ ).
4. The EUT shall be replaced by a substitution antenna. In the chamber, an substitution antenna for the frequency band of interest is placed at the reference point of the chamber. An RF Signal source for the frequency band of interest is connected to the substitution antenna with a cable that has been constructed to not interfere with the radiation pattern of the antenna. A power ( $P_{Mea}$ ) is applied to the input of the substitution antenna, and adjust the level of the signal generator output until the value of the receiver reach the previously recorded ( $P_r$ ). The power of signal source ( $P_{Mea}$ ) is recorded. The test should be performed by rotating the test item and adjusting the receiving antenna polarization.
5. A amplifier should be connected to the Signal Source output port. And the cable should be connect between the Amplifier and the Substitution Antenna. The cable loss ( $P_{cl}$ ), the Substitution Antenna Gain ( $G_a$ ) and the Amplifier Gain ( $P_{Ag}$ ) should be recorded after test.  
The measurement results are obtained as described below:  
 $Power(EIRP)=P_{Mea}- P_{Ag} - P_{cl} + G_a$
6. This value is EIRP since the measurement is calibrated using an antenna of known gain (2.15 dBi) and known input power.
7. ERP can be calculated from EIRP by subtracting the gain of the dipole,  $ERP = EIRP -2.15dBi$ .
8. In order to make sure test results more clearly,we set frequency range and sweep time for difference frequency range as follows table:

Working Frequency	Subrange (GHz)	RBW	VBW	Sweep time (s)
GSM 850	0.00009~0.15	1KHz	3KHz	30
	0.00015~0.03	10KHz	30KHz	10
	0.03~1	100KHz	300KHz	10
	1~2	1 MHz	3 MHz	2
	2~5	1 MHz	3 MHz	3
	5~8	1 MHz	3 MHz	3
	8~10	1 MHz	3 MHz	3
PCS 1900	0.00009~0.15	1KHz	3KHz	30
	0.00015~0.03	10KHz	30KHz	10
	0.03~1	100KHz	300KHz	10
	1~2	1 MHz	3 MHz	2
	2~5	1 MHz	3 MHz	3
	5~8	1 MHz	3 MHz	3
	8~11	1 MHz	3 MHz	3
	11~14	1 MHz	3 MHz	3
	14~18	1 MHz	3 MHz	3
18~20	1 MHz	3 MHz	2	

**TEST LIMITS**

According to 24.238 and 22.917 specify that the power of any emission outside of the authorized operating frequency ranges must be attenuated below the transmitting power (P) by a factor of at least  $43 + 10 \log(P)$  dB.

The specification that emissions shall be attenuated below the transmitter power (P) by at least  $43 + 10 \log(P)$  dB, translates in the relevant power range (1 to 0.001 W) to -13 dBm. At 1 W the specified minimum attenuation becomes 43 dB and relative to a 30 dBm (1 W) carrier becomes a limit of -13 dBm. At 0.001 W (0 dBm) the minimum attenuation is 13 dB, which again yields a limit of -13 dBm. In this way a translation of the specification from relative to absolute terms is carried out.

Frequency	Channel	Frequency Range	Verdict
GSM 850	Low	9KHz-10GHz	PASS
	Middle	9KHz -10GHz	PASS
	High	9KHz -10GHz	PASS
PCS 1900	Low	9KHz -20GHz	PASS
	Middle	9KHz -20GHz	PASS
	High	9KHz -20GHz	PASS

**TEST RESULTS**

Remark:

1. We were tested all refer 3GPP TS151 010.
2.  $EIRP = P_{Mea}(dBm) - P_{cl}(dB) + G_a(dBi)$
3. We were not recorded other points as values lower than limits.
4. Margin = Limit - EIRP

*GSM 850\_Low Channel*

Frequency (MHz)	P <sub>Mea</sub> (dBm)	P <sub>cl</sub> (dB)	Diatance	Ga Antenna Gain(dB)	Peak EIRP (dBm)	Limit (dBm)	Margin (dB)	Polarization
1648.4	-35.05	3.00	3.00	9.58	-28.47	-13	15.47	H
2472.6	-34.7	3.03	3.00	10.72	-27.01	-13	14.01	H
1648.4	-37.6	3.00	3.00	9.68	-30.92	-13	17.92	V
2472.6	-36.36	3.03	3.00	10.72	-28.67	-13	15.67	V

*GSM 850\_Middle Channel*

Frequency (MHz)	P <sub>Mea</sub> (dBm)	P <sub>cl</sub> (dB)	Diatance	Ga Antenna Gain(dB)	EIRP (dBm)	Limit (dBm)	Margin (dB)	Polarization
1673.2	-35.87	3.00	3.00	9.58	-29.29	-13	16.29	H
2509.8	-33.31	3.03	3.00	10.72	-25.62	-13	12.62	H
1673.2	-31.43	3.00	3.00	9.68	-24.75	-13	11.75	V
2509.8	-37.44	3.03	3.00	10.72	-29.75	-13	16.75	V

*GSM 850\_High Channel*

Frequency (MHz)	P <sub>Mea</sub> (dBm)	P <sub>cl</sub> (dB)	Diatance	Ga Antenna Gain(dB)	EIRP (dBm)	Limit (dBm)	Margin (dB)	Polarization
1697.6	-32.76	3.00	3.00	9.58	-26.18	-13	13.18	H
2546.4	-34.51	3.03	3.00	10.72	-26.82	-13	13.82	H
1697.6	-30.94	3.00	3.00	9.68	-24.26	-13	11.26	V
2546.4	-31.89	3.03	3.00	10.72	-24.2	-13	11.2	V

*GSM 1900\_Low Channel*

Frequency (MHz)	P <sub>Mea</sub> (dBm)	P <sub>cl</sub> (dB)	Diatance	Ga Antenna Gain(dB)	Peak EIRP (dBm)	Limit (dBm)	Margin (dB)	Polarization
3700.4	-39.42	4.39	3.00	12.34	-31.47	-13.00	18.47	H
5550.6	-38.02	5.31	3.00	13.52	-29.81	-13.00	16.81	H
3700.4	-39.74	4.39	3.00	12.34	-31.79	-13.00	18.79	V
5550.6	-37.31	5.31	3.00	13.52	-29.1	-13.00	16.1	V

*GSM 1900\_Middle Channel*

Frequency (MHz)	P <sub>Mea</sub> (dBm)	P <sub>cl</sub> (dB)	Diatance	Ga Antenna Gain(dB)	EIRP (dBm)	Limit (dBm)	Margin (dB)	Polarization
3760.0	-37.1	4.41	3.00	12.34	-29.17	-13.00	16.17	H
5640.0	-40.4	5.38	3.00	13.58	-32.2	-13.00	19.2	H
3760.0	-36.29	4.41	3.00	12.34	-28.36	-13.00	15.36	V
5640.0	-42.14	5.38	3.00	13.58	-33.94	-13.00	20.94	V

*GSM 1900\_High Channel*

Frequency (MHz)	P <sub>Mea</sub> (dBm)	P <sub>cl</sub> (dB)	Diatance	Ga Antenna Gain(dB)	EIRP (dBm)	Limit (dBm)	Margin (dB)	Polarization
3819.6	-34.89	4.45	3.00	12.45	-26.89	-13.00	13.89	H
5729.4	-40.43	5.47	3.00	13.66	-32.24	-13.00	19.24	H
3819.6	-38.1	4.45	3.00	12.45	-30.1	-13.00	17.1	V
5729.4	-40.63	5.48	3.00	13.66	-32.45	-13.00	19.45	V

*GPRS 850\_Low Channel*

Frequency (MHz)	P <sub>Mea</sub> (dBm)	P <sub>cl</sub> (dB)	Diatance	Ga Antenna Gain(dB)	Peak EIRP (dBm)	Limit (dBm)	Margin (dB)	Polarization
1648.4	-35.25	3.00	3.00	9.58	-28.67	-13	15.67	H
2472.6	-34.83	3.03	3.00	10.72	-27.14	-13	14.14	H
1648.4	-37.34	3.00	3.00	9.68	-30.66	-13	17.66	V
2472.6	-36.57	3.03	3.00	10.72	-28.88	-13	15.88	V

*GPRS 850\_Middle Channel*

Frequency (MHz)	P <sub>Mea</sub> (dBm)	P <sub>cl</sub> (dB)	Diatance	Ga Antenna Gain(dB)	EIRP (dBm)	Limit (dBm)	Margin (dB)	Polarization
1673.2	-35.62	3.00	3.00	9.58	-29.04	-13	16.04	H
2509.8	-32.94	3.03	3.00	10.72	-25.25	-13	12.25	H
1673.2	-31.5	3.00	3.00	9.68	-24.82	-13	11.82	V
2509.8	-36.59	3.03	3.00	10.72	-28.9	-13	15.9	V

*GPRS 850\_High Channel*

Frequency (MHz)	P <sub>Mea</sub> (dBm)	P <sub>cl</sub> (dB)	Diatance	Ga Antenna Gain(dB)	EIRP (dBm)	Limit (dBm)	Margin (dB)	Polarization
1697.6	-32.81	3.00	3.00	9.58	-26.23	-13	13.23	H
2546.4	-35.16	3.03	3.00	10.72	-27.47	-13	14.47	H
1697.6	-30.96	3.00	3.00	9.68	-24.28	-13	11.28	V
2546.4	-31.54	3.03	3.00	10.72	-23.85	-13	10.85	V

*GPRS 1900\_Low Channel*

Frequency (MHz)	P <sub>Mea</sub> (dBm)	P <sub>cl</sub> (dB)	Diatance	Ga Antenna Gain(dB)	Peak EIRP (dBm)	Limit (dBm)	Margin (dB)	Polarization
3700.4	-38.87	4.39	3.00	12.34	-30.92	-13.00	17.92	H
5550.6	-37.65	5.31	3.00	13.52	-29.44	-13.00	16.44	H
3700.4	-40.18	4.39	3.00	12.34	-32.23	-13.00	19.23	V
5550.6	-37.46	5.31	3.00	13.52	-29.25	-13.00	16.25	V

*GPRS 1900\_Middle Channel*

Frequency (MHz)	P <sub>Mea</sub> (dBm)	P <sub>cl</sub> (dB)	Diatance	Ga Antenna Gain(dB)	EIRP (dBm)	Limit (dBm)	Margin (dB)	Polarization
3760.0	-36.43	4.41	3.00	12.34	-28.5	-13.00	15.5	H
5640.0	-40.01	5.38	3.00	13.58	-31.81	-13.00	18.81	H
3760.0	-36.09	4.41	3.00	12.34	-28.16	-13.00	15.16	V
5640.0	-41.27	5.38	3.00	13.58	-33.07	-13.00	20.07	V

*GPRS 1900\_High Channel*

Frequency (MHz)	P <sub>Mea</sub> (dBm)	P <sub>cl</sub> (dB)	Diatance	Ga Antenna Gain(dB)	EIRP (dBm)	Limit (dBm)	Margin (dB)	Polarization
3819.6	-34.82	4.45	3.00	12.45	-26.82	-13.00	13.82	H
5729.4	-39.94	5.47	3.00	13.66	-31.75	-13.00	18.75	H
3819.6	-37.79	4.45	3.00	12.45	-29.79	-13.00	16.79	V
5729.4	-40.74	5.48	3.00	13.66	-32.56	-13.00	19.56	V

*EGPRS 850\_ Low Channel*

Frequency (MHz)	P <sub>Mea</sub> (dBm)	Pcl (dB)	Diatance	Ga Antenna Gain(dB)	Peak EIRP (dBm)	Limit (dBm)	Margin (dB)	Polarization
1648.4	-35.74	3.00	3.00	9.58	-29.16	-13	16.16	H
2472.6	-35.17	3.03	3.00	10.72	-27.48	-13	14.48	H
1648.4	-37.71	3.00	3.00	9.68	-31.03	-13	18.03	V
2472.6	-36.13	3.03	3.00	10.72	-28.44	-13	15.44	V

*EGPRS 850\_ Middle Channel*

Frequency (MHz)	P <sub>Mea</sub> (dBm)	Pcl (dB)	Diatance	Ga Antenna Gain(dB)	EIRP (dBm)	Limit (dBm)	Margin (dB)	Polarization
1673.2	-36.54	3.00	3.00	9.58	-29.96	-13	16.96	H
2509.8	-33.64	3.03	3.00	10.72	-25.95	-13	12.95	H
1673.2	-31.44	3.00	3.00	9.68	-24.76	-13	11.76	V
2509.8	-37.41	3.03	3.00	10.72	-29.72	-13	16.72	V

*EGPRS 850\_ High Channel*

Frequency (MHz)	P <sub>Mea</sub> (dBm)	Pcl (dB)	Diatance	Ga Antenna Gain(dB)	EIRP (dBm)	Limit (dBm)	Margin (dB)	Polarization
1697.6	-32.63	3.00	3.00	9.58	-26.05	-13	13.05	H
2546.4	-35.1	3.03	3.00	10.72	-27.41	-13	14.41	H
1697.6	-31.09	3.00	3.00	9.68	-24.41	-13	11.41	V
2546.4	-32.18	3.03	3.00	10.72	-24.49	-13	11.49	V

*EGPRS 1900\_ Low Channel*

Frequency (MHz)	P <sub>Mea</sub> (dBm)	Pcl (dB)	Diatance	Ga Antenna Gain(dB)	Peak EIRP (dBm)	Limit (dBm)	Margin (dB)	Polarization
3700.4	-39.77	4.39	3.00	12.34	-31.82	-13.00	18.82	H
5550.6	-38.09	5.31	3.00	13.52	-29.88	-13.00	16.88	H
3700.4	-39.57	4.39	3.00	12.34	-31.62	-13.00	18.62	V
5550.6	-37.41	5.31	3.00	13.52	-29.2	-13.00	16.2	V

*EGPRS 1900\_ Middle Channel*

Frequency (MHz)	P <sub>Mea</sub> (dBm)	Pcl (dB)	Diatance	Ga Antenna Gain(dB)	EIRP (dBm)	Limit (dBm)	Margin (dB)	Polarization
3760.0	-36.59	4.41	3.00	12.34	-28.66	-13.00	15.66	H
5640.0	-40.71	5.38	3.00	13.58	-32.51	-13.00	19.51	H
3760.0	-36.22	4.41	3.00	12.34	-28.29	-13.00	15.29	V
5640.0	-41.52	5.38	3.00	13.58	-33.32	-13.00	20.32	V

*EGPRS 1900\_ High Channel*

Frequency (MHz)	P <sub>Mea</sub> (dBm)	Pcl (dB)	Diatance	Ga Antenna Gain(dB)	EIRP (dBm)	Limit (dBm)	Margin (dB)	Polarization
3819.6	-34.86	4.45	3.00	12.45	-26.86	-13.00	13.86	H
5729.4	-40.2	5.47	3.00	13.66	-32.01	-13.00	19.01	H
3819.6	-37.63	4.45	3.00	12.45	-29.63	-13.00	16.63	V
5729.4	-40.44	5.48	3.00	13.66	-32.26	-13.00	19.26	V



### 4.3 Occupied Bandwidth and Emission Bandwidth

#### TEST APPLICABLE

Similar to conducted emissions; occupied bandwidth measurements are only provided for selected frequencies in order to reduce the amount of submitted data. Data were taken at the extreme and mid frequencies of PCS1900 band and GSM850 band. The table below lists the measured 99% Bandwidth and -26dBc Bandwidth.

#### TEST CONFIGURATION

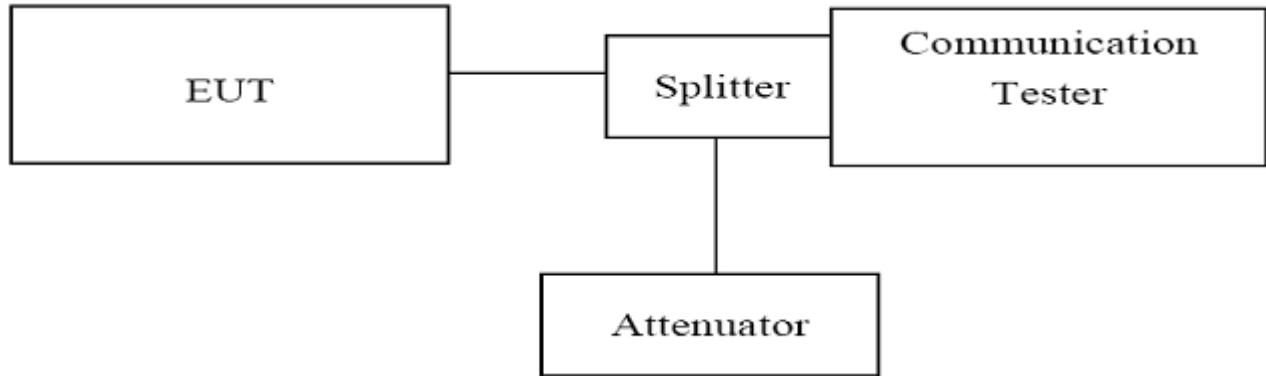

#### TEST PROCEDURE

1. The EUT was set up for the max output power with pseudo random data modulation;
2. The Occupied bandwidth and Emission Bandwidth were measured with Agilent Spectrum Analyzer N9020A (peak);
3. Set RBW=5.1KHz,VBW=51KHz,Span=1MHz,SWT=500ms;
4. Set SPA Max hold and View, Set 99% Occupied Bandwidth/ Set -26dBc Occupied Bandwidth
5. These measurements were done at 3 frequencies, 1850.20 MHz, 1880.00 MHz and 1909.80 MHz for PCS1900 band; 824.20MHz, 836.60 MHz and 848.80 MHz for GSM850 band. (Low, middle and high of operational frequency range).

#### TEST RESULTS

GSM 850				
Channel Number	Frequency (MHz)	Occupied Bandwidth (99% BW) ( kHz)	Emission Bandwidth (26 dBc BW) ( kHz)	Verdict
128	824.20	245.4	319	PASS
190	836.60	246.1	308	PASS
251	848.80	246.2	315	PASS

GSM 1900				
Channel Number	Frequency (MHz)	Occupied Bandwidth (99% BW) ( kHz)	Emission Bandwidth (26 dBc BW) ( kHz)	Verdict
512	1850.20	245.7	311	PASS
661	1880.00	243.7	310	PASS
810	1909.80	247.6	315	PASS

GPRS 850				
Channel Number	Frequency (MHz)	Occupied Bandwidth (99% BW) ( kHz)	Emission Bandwidth (26 dBc BW) ( kHz)	Verdict
128	824.20	245.2	312	PASS
190	836.60	246.5	317	PASS
251	848.80	245.7	308	PASS



GPRS 1900				
Channel Number	Frequency (MHz)	Occupied Bandwidth (99% BW) ( kHz)	Emission Bandwidth (26 dBc BW) ( kHz)	Verdict
512	1850.20	248.1	317	PASS
661	1880.00	247.1	307	PASS
810	1909.80	246.0	314	PASS

EGPRS 850				
Channel Number	Frequency (MHz)	Occupied Bandwidth (99% BW) ( kHz)	Emission Bandwidth (26 dBc BW) ( kHz)	Verdict
128	824.20	248.5	312	PASS
190	836.60	247.8	308	PASS
251	848.80	248.9	308	PASS

EGPRS 1900				
Channel Number	Frequency (MHz)	Occupied Bandwidth (99% BW) ( kHz)	Emission Bandwidth (26 dBc BW) ( kHz)	Verdict
512	1850.20	246.2	314	PASS
661	1880.00	250.9	297	PASS
810	1909.80	249.2	311	PASS

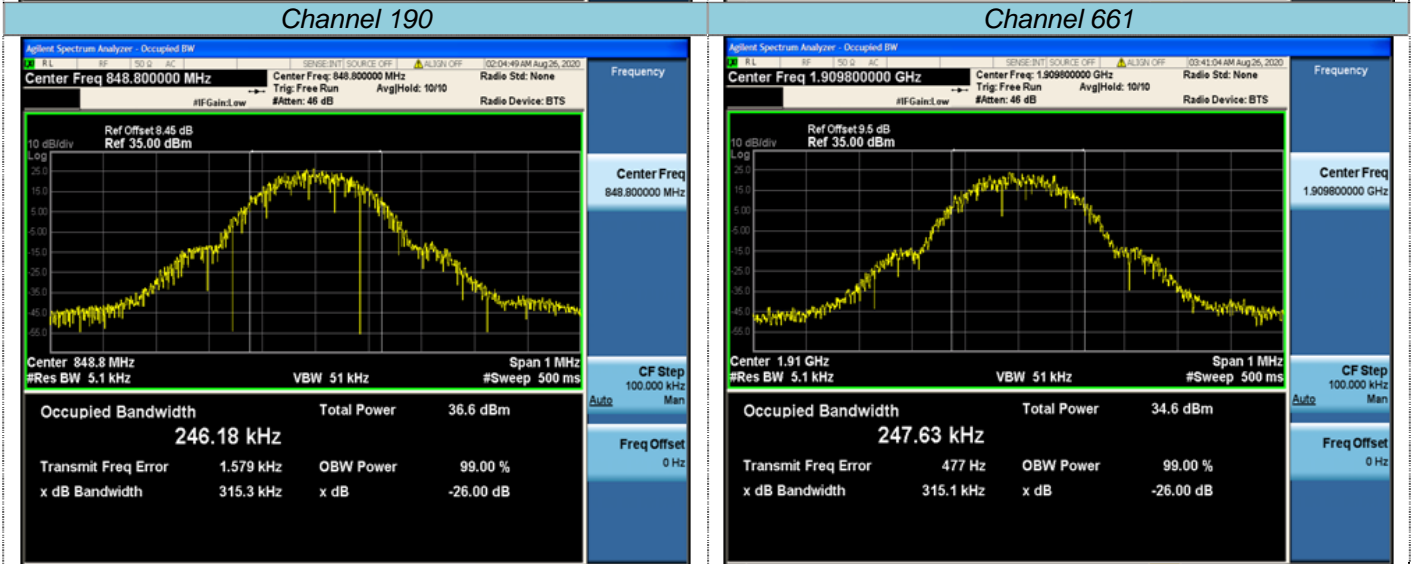
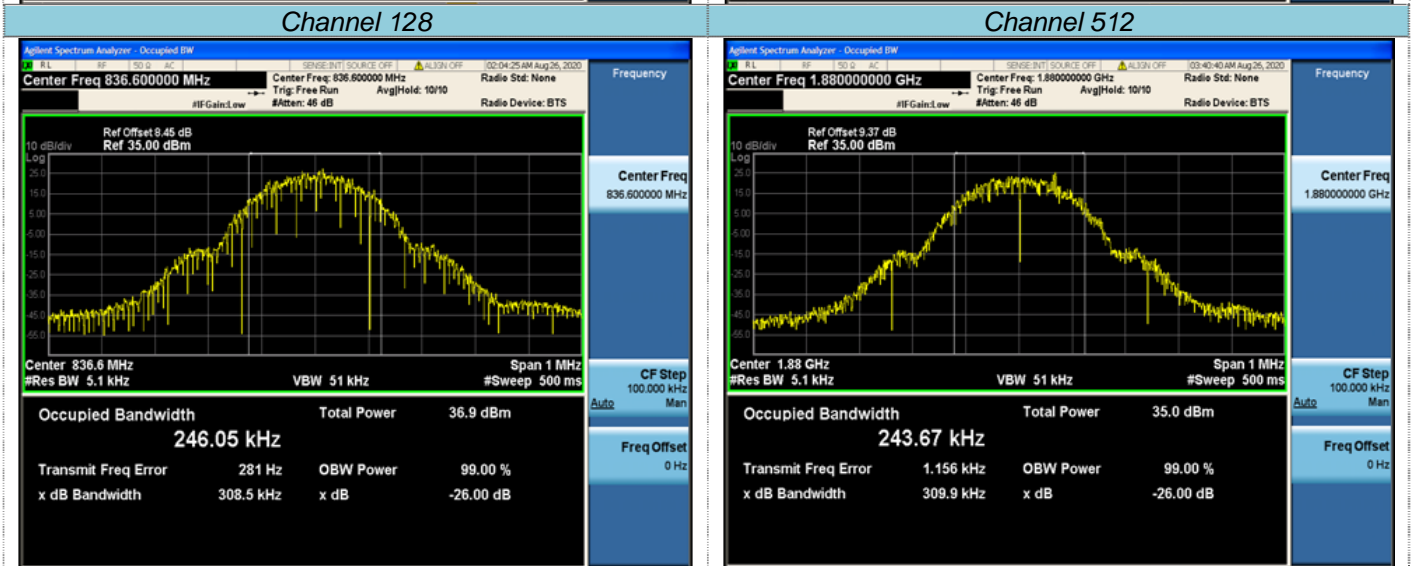
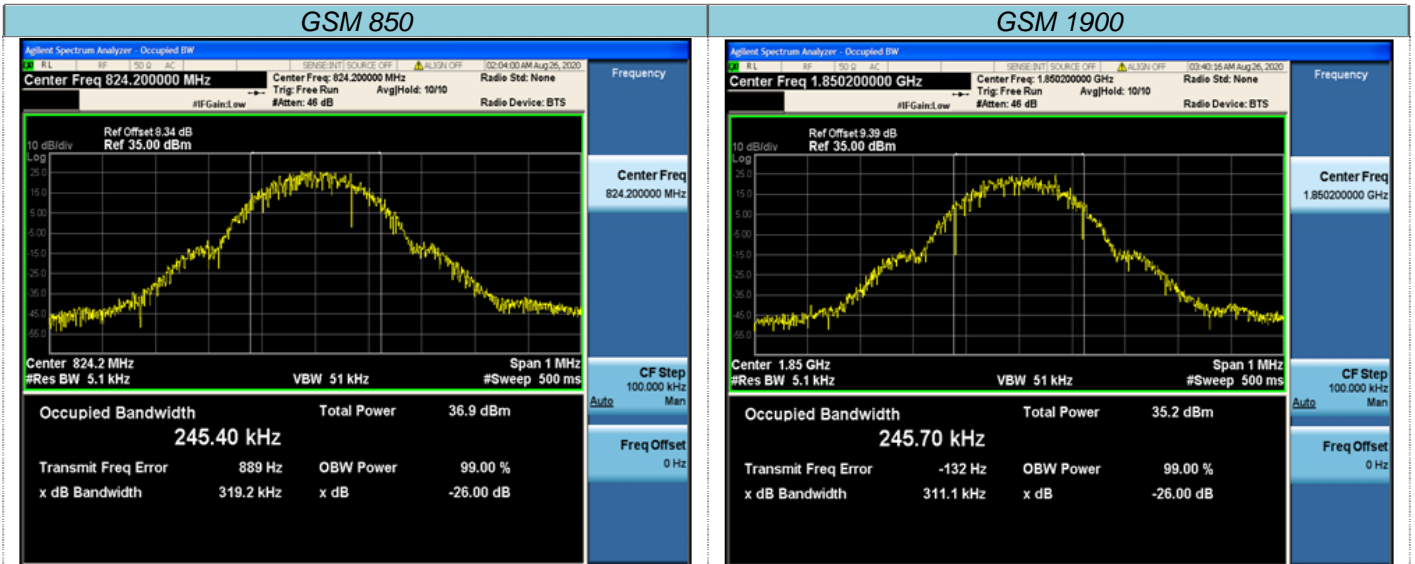

Channel 251	Channel 810
-------------	-------------



GPRS 850

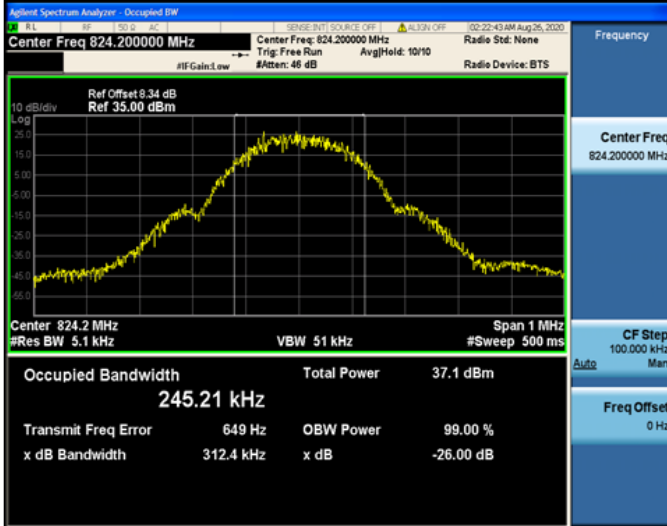

GPRS 1900

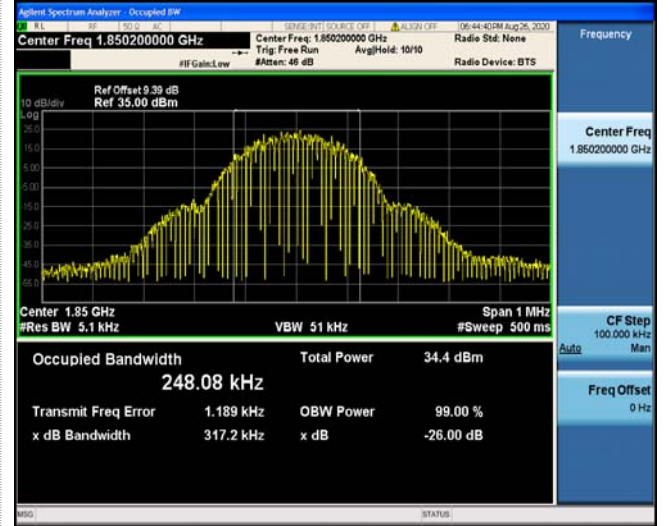

Channel 128

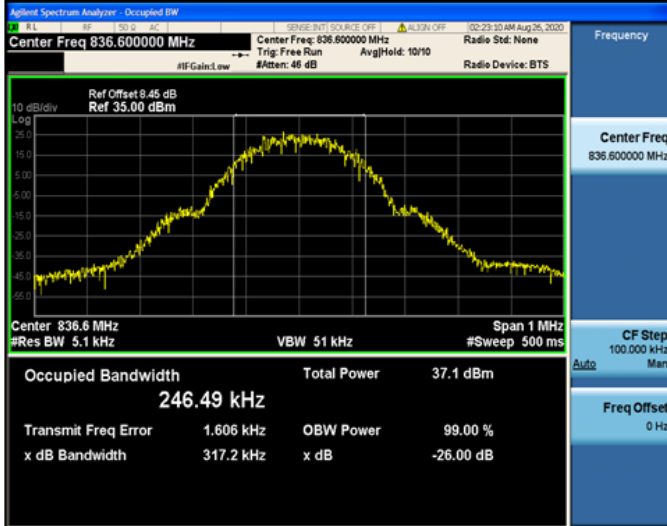

Channel 512



Channel 190

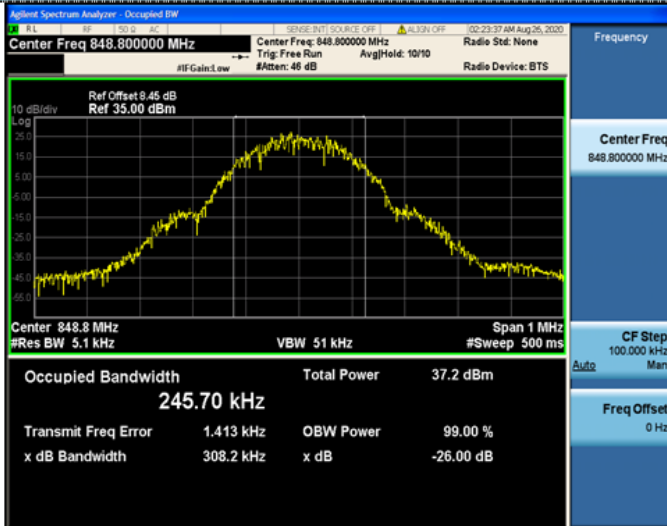

Channel 661

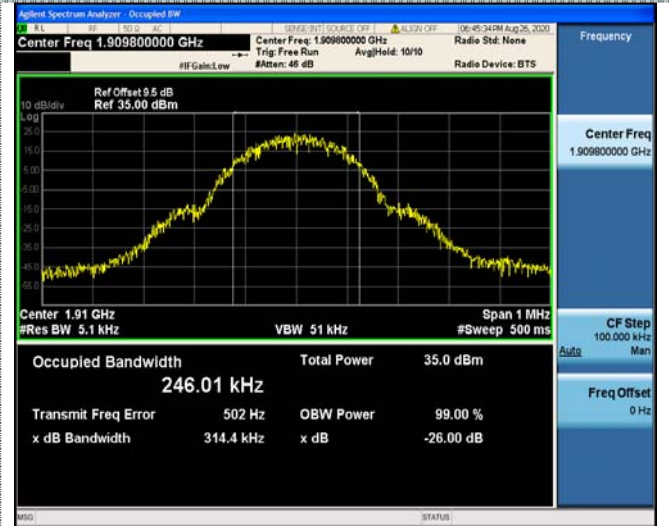

Channel 251

Channel 810





EGPRS 850

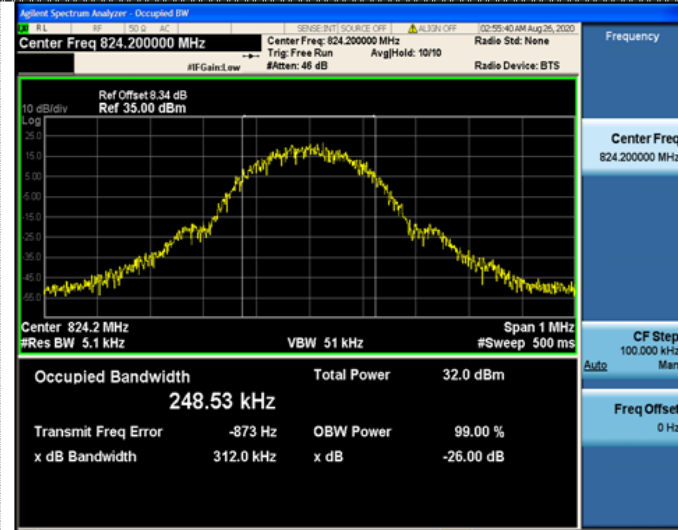

EGPRS 1900

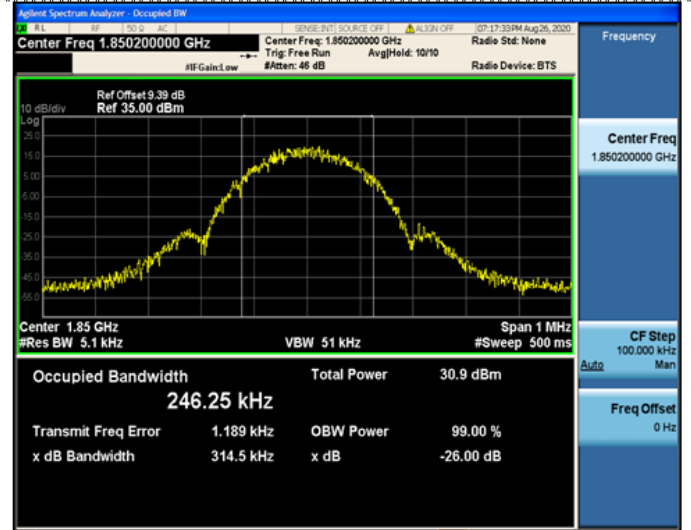

Channel 128

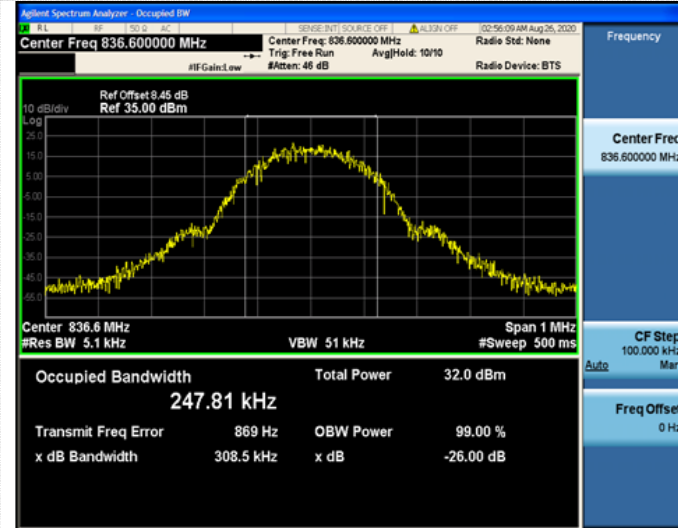

Channel 512

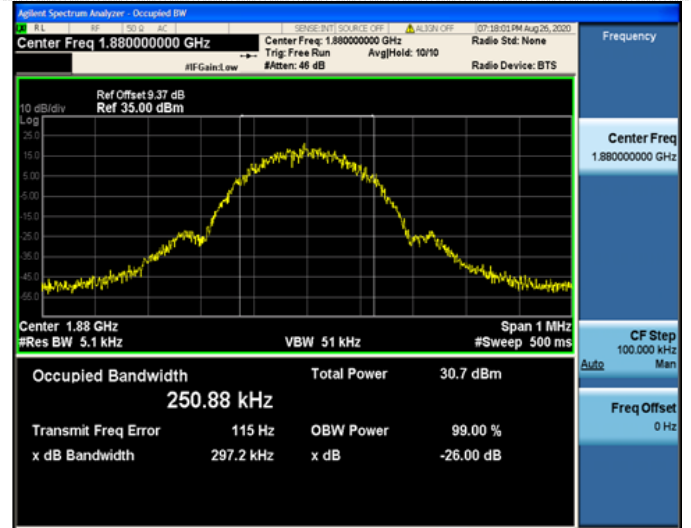

Channel 190

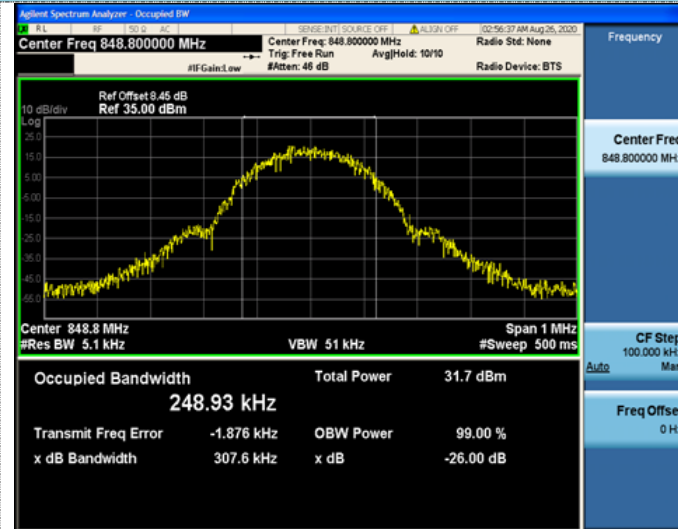

Channel 661

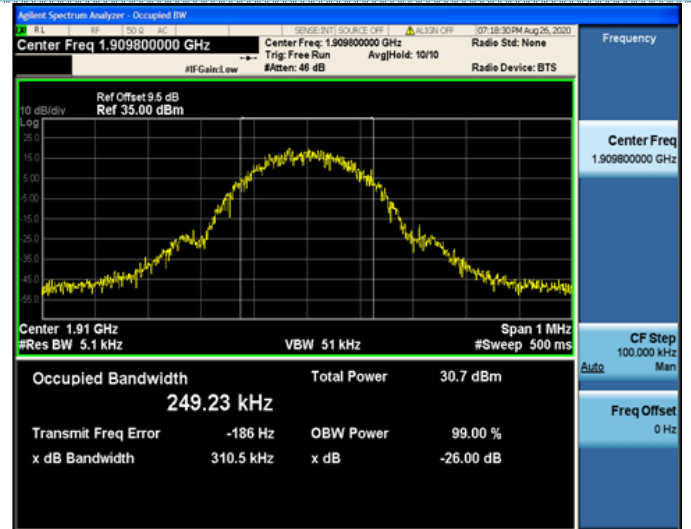

Channel 251

Channel 810



### 4.4 Band Edge Compliance

#### TEST APPLICABLE

During the process of testing, the EUT was controlled via Agilent Digital Radio Communication tester (CMW500) to ensure max power transmission and proper modulation.

#### TEST CONFIGURATION

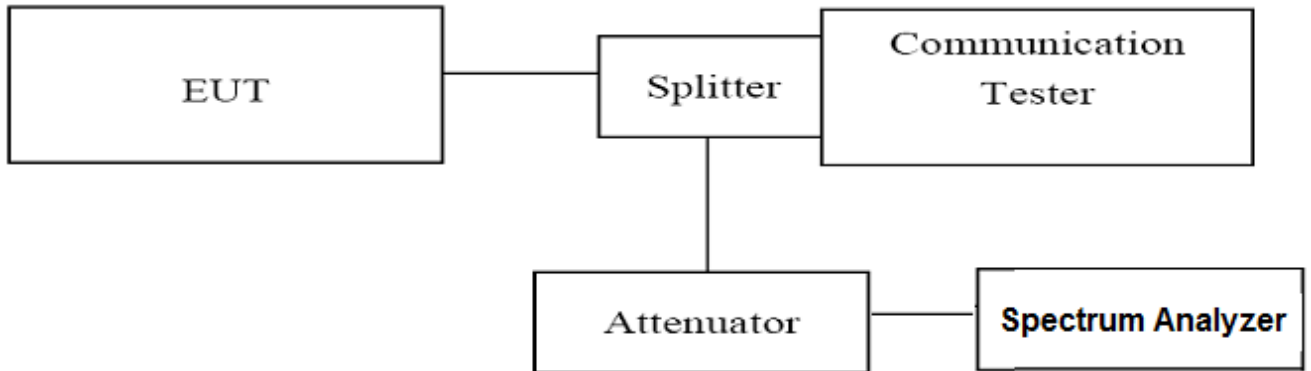

#### TEST PROCEDURE

1. The EUT was set up for the max output power with pseudo random data modulation;
2. The power was measured with Agilent Spectrum Analyzer N9020A;
3. Set RBW=5.1KHz,VBW=51KHz,Span=3MHz,SWT=300ms, Dector: RMS;
4. These measurements were done at 3 frequencies, 1850.20 MHz, 1880.00 MHz and 1909.80 MHz for PCS1900 band; 824.20 MHz, 836.60 MHz and 848.80 MHz for GSM850 band. (bottom, middle and top of operational frequency range).

#### TEST RESULTS

GSM 850					
Channel Number	Frequency (MHz)	Measurement Results		Limit (dBm)	Verdict
		Frequency (MHz)	Values (dBm)		
128	824.20	823.984	-17.55	-13.00	PASS
251	848.80	849.020	-17.55	-13.00	PASS

GSM 1900					
Channel Number	Frequency (MHz)	Measurement Results		Limit (dBm)	Verdict
		Frequency (MHz)	Values (dBm)		
512	1850.20	1849.998	-17.39	-13.00	PASS
810	1909.80	1910.021	-19.27	-13.00	PASS

GPRS 850					
Channel Number	Frequency (MHz)	Measurement Results		Limit (dBm)	Verdict
		Frequency (MHz)	Values (dBm)		
128	824.20	823.996	-16.64	-13.00	PASS
251	848.80	849.021	-17.57	-13.00	PASS

GPRS 1900					
Channel Number	Frequency (MHz)	Measurement Results		Limit (dBm)	Verdict
		Frequency (MHz)	Values (dBm)		
512	1850.20	1849.979	-19.07	-13.00	PASS
810	1909.80	1910.016	-18.55	-13.00	PASS



EGPRS 850					
Channel Number	Frequency (MHz)	Measurement Results		Limit (dBm)	Verdict
		Frequency (MHz)	Values (dBm)		
128	824.20	823.992	-25.18	-13.00	PASS
251	848.80	849.038	-25.86	-13.00	PASS

EGPRS 1900					
Channel Number	Frequency (MHz)	Measurement Results		Limit (dBm)	Verdict
		Frequency (MHz)	Values (dBm)		
512	1850.20	1849.997	-24.00	-13.00	PASS
810	1909.80	1910.017	-28.12	-13.00	PASS



GSM 850

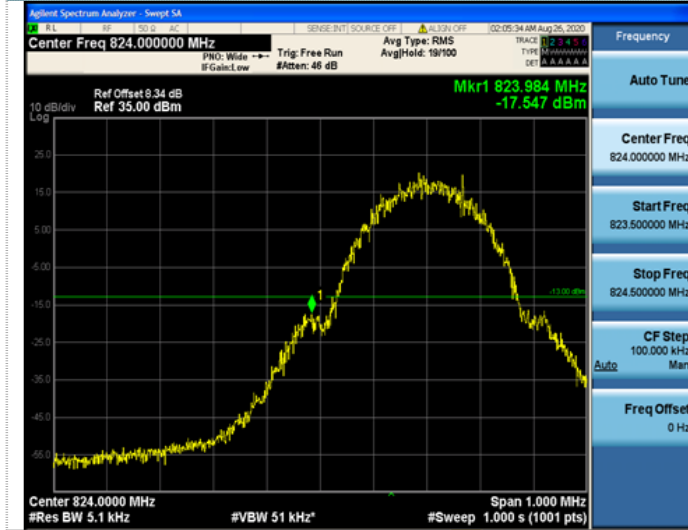

GSM 1900

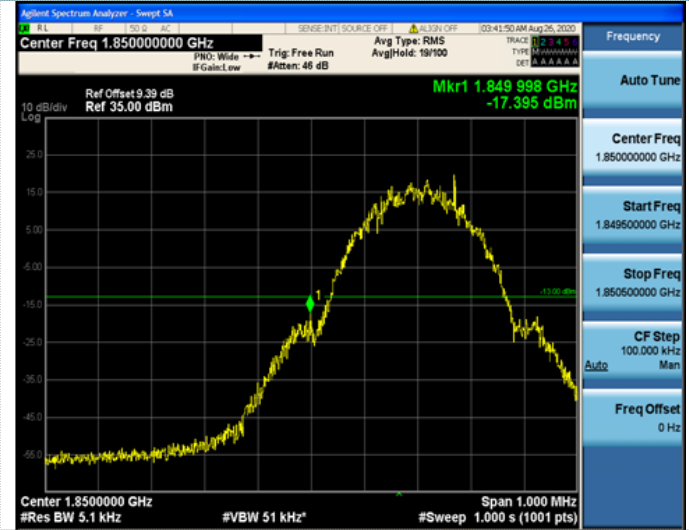

Channel 128

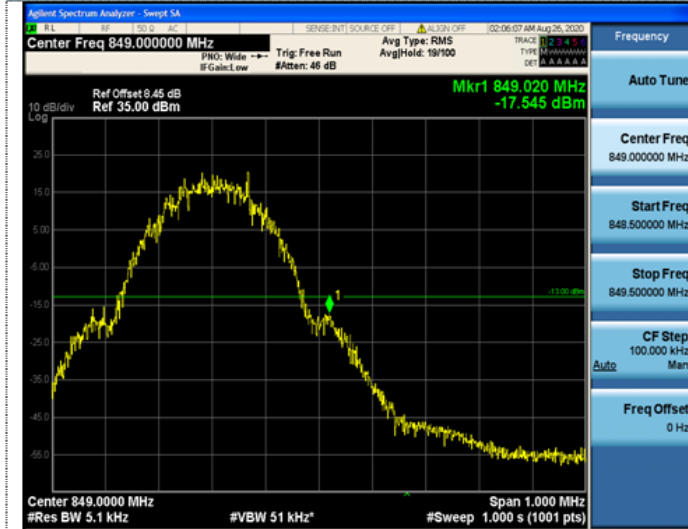

Channel 512

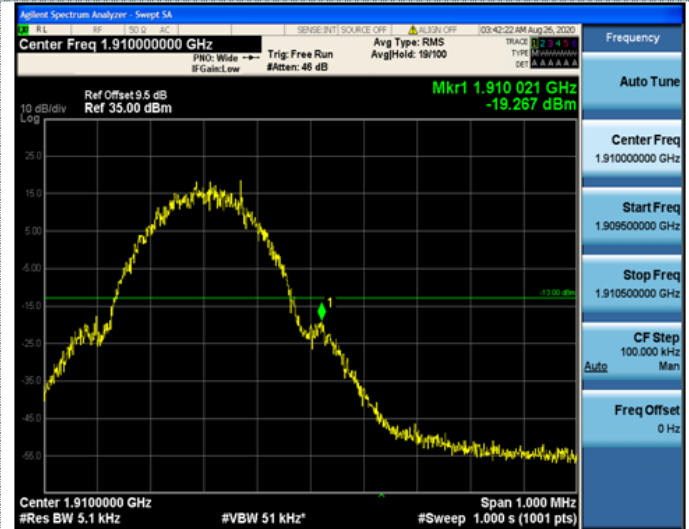

Channel 251

Channel 810



GPRS 850

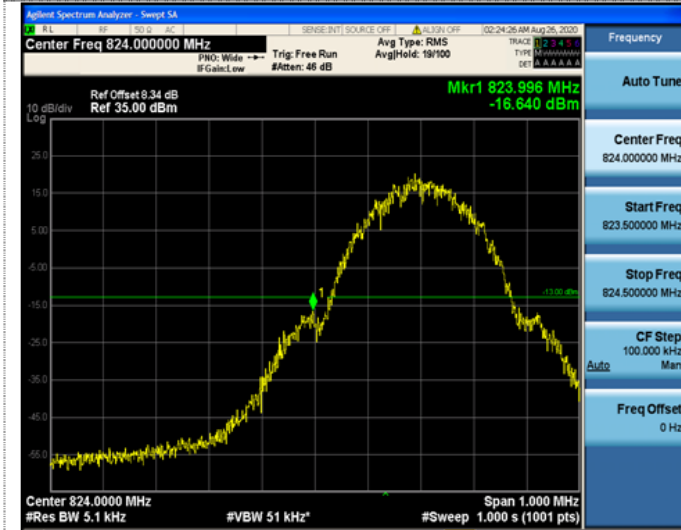

GPRS 1900

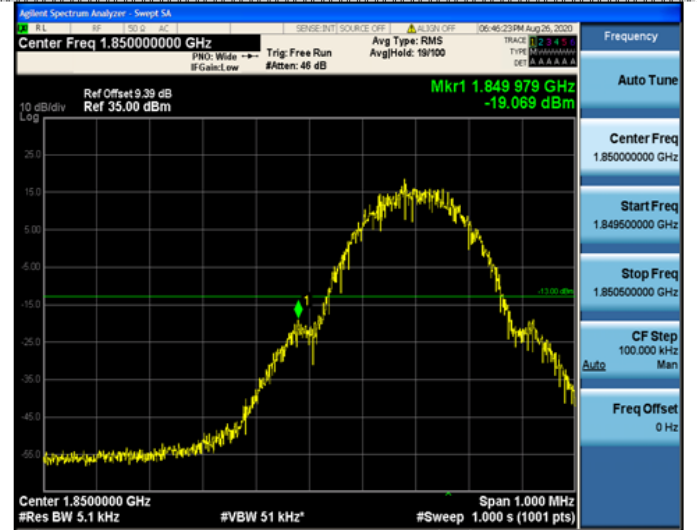

Channel 128

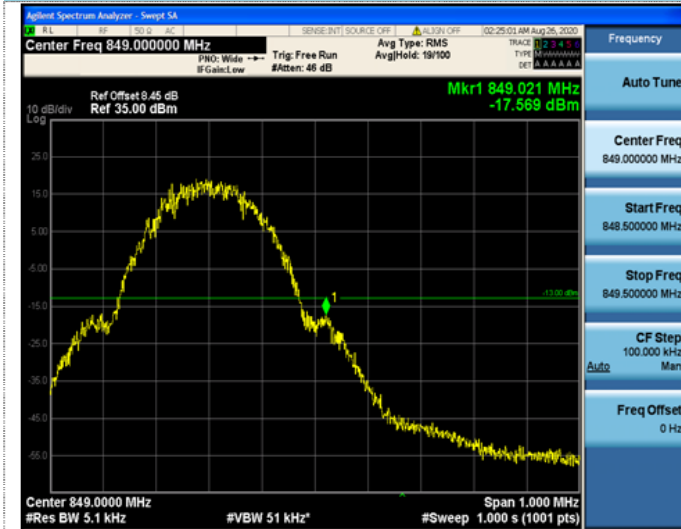

Channel 512

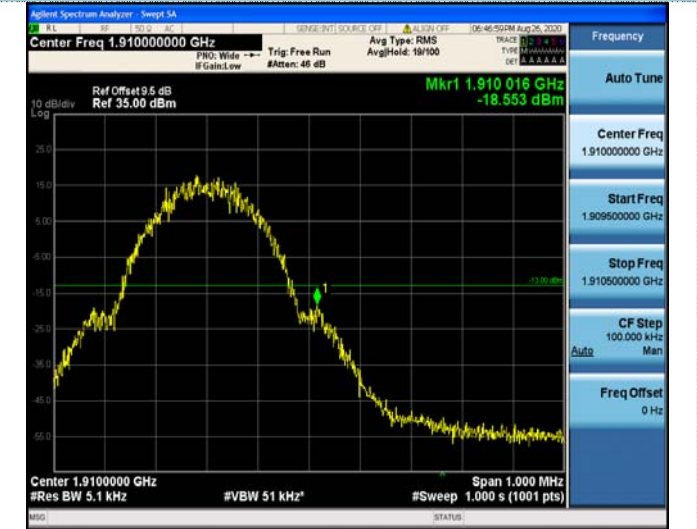

Channel 251

Channel 810



EGPRS 850

EGPRS 1900

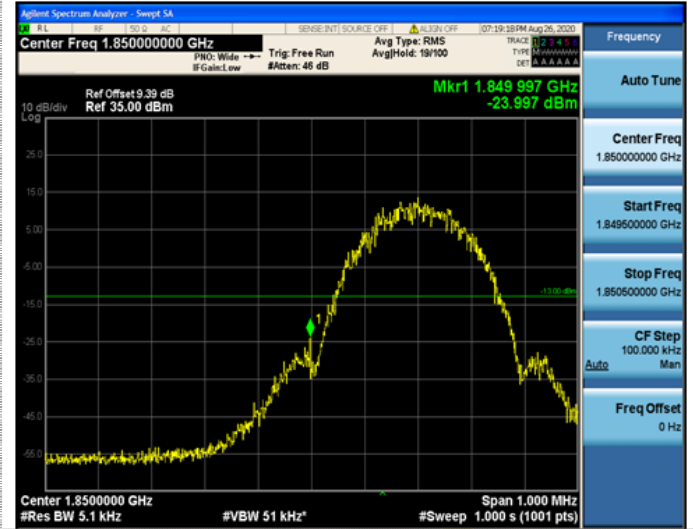
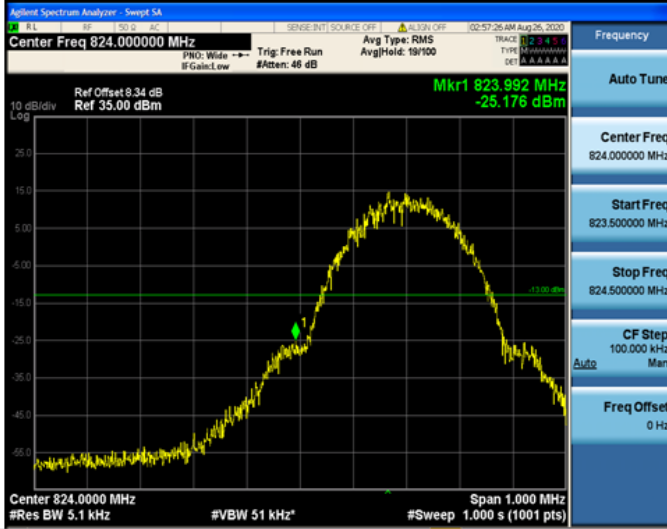

Channel 128

Channel 512

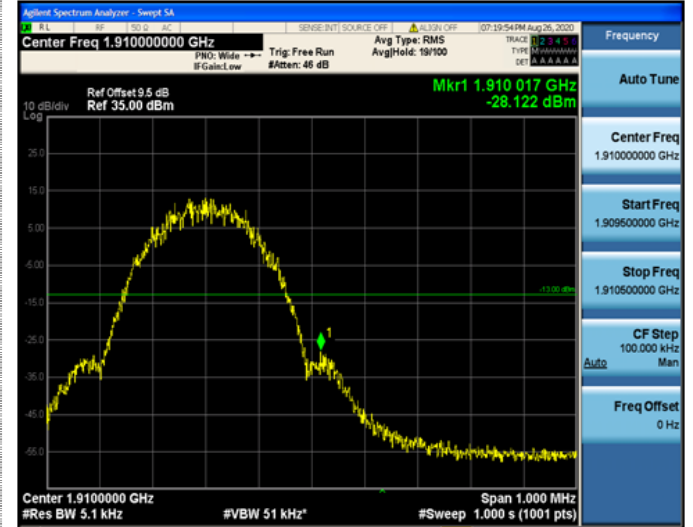
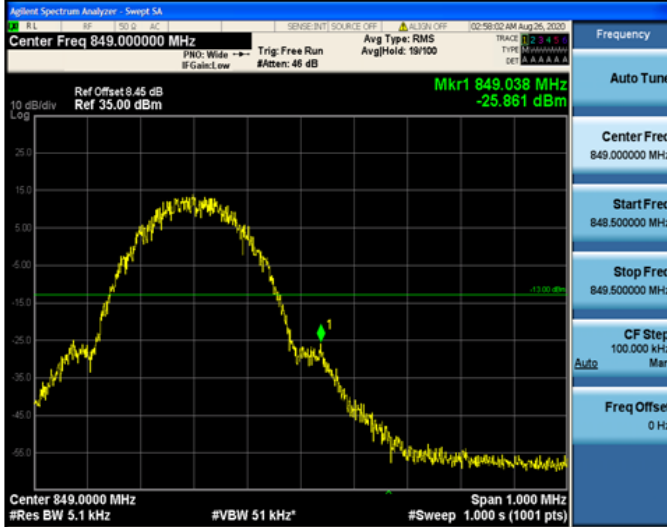

Channel 251

Channel 810



## 4.5 Spurious Emission on Antenna Port

### TEST APPLICABLE

The following steps outline the procedure used to measure the conducted emissions from the EUT.

1. Determine frequency range for measurements: From CFR 2.1057 the spectrum should be investigated from the lowest radio frequency generated in the equipment up to at least the 10<sup>th</sup> harmonic of the carrier frequency. For the equipment of PCS1900 band, this equates to a frequency range of 9 KHz to 19.1 GHz, data taken from 9 KHz to 25 GHz. For GSM850, data taken from 9 KHz to 9 GHz.
2. The sweep time is set automatically by instrument itself. That should be the optimal sweep time for the span and the RBW. If the sweep time is too short, that is sweep is too fast, the sweep result is not accurate; if the sweep time is too long, that is sweep is too low, some frequency components may be lost. The instrument will give an optimal sweep time according the selected span and RBW.
3. The procedure to get the conducted spurious emission is as follows:  
The trace mode is set to MaxHold to get the highest signal at each frequency;  
Wait 25 seconds;  
Get the result.
4. Determine EUT transmit frequencies: below outlines the band edge frequencies pertinent to conducted emissions testing.

### TEST CONFIGURATION

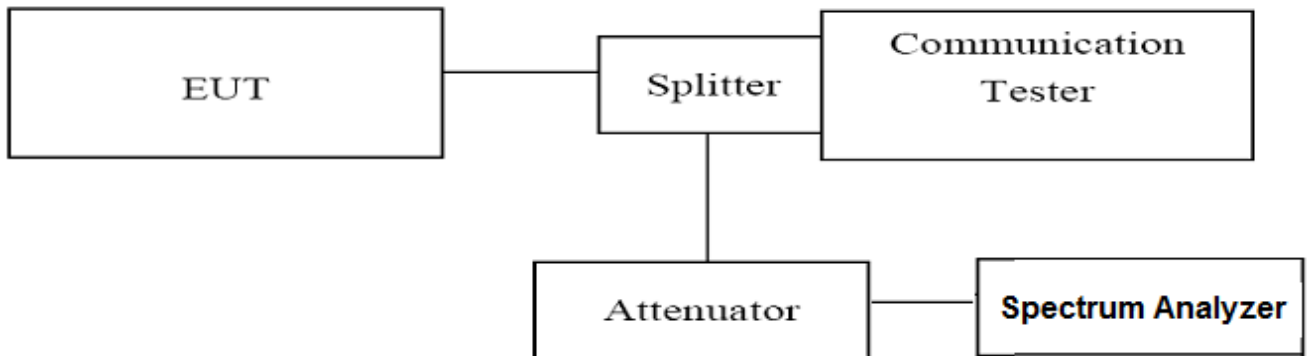

### TEST PROCEDURE

1. The EUT was set up for the max output power with pseudo random data modulation;
2. The power was measured with Agilent Spectrum Analyzer N9020A (peak);
3. These measurements were done at 3 frequencies, 1850.20 MHz, 1880.00 MHz and 1909.80 MHz for PCS1900 band; 824.20 MHz, 836.60 MHz and 848.80 MHz for GSM850 band. (Low, middle and high of operational frequency range).

### TEST LIMIT

Part 24.238 and Part 22.917 specify that the power of any emission outside of the authorized operating frequency ranges must be attenuated below the transmitting power (P) by a factor of at least  $43 + 10 \log(P)$  dB.

The specification that emissions shall be attenuated below the transmitter power (P) by at least  $43 + 10 \log(P)$  dB, translates in the relevant power range (1 to 0.001 W) to -13 dBm. At 1 W the specified minimum attenuation becomes 43 dB and relative to a 30 dBm (1 W) carrier becomes a limit of -13 dBm. At 0.001 W (0 dBm) the minimum attenuation is 13 dB, which again yields a limit of -13 dBm. In this way a translation of the specification from relative to absolute terms is carried out.

### TEST RESULTS

**Note: We tested GSM/GPRS/EGPRS mode and recorded the worst case at the GPRS mode.**



#### 4.5.1 For GPRS 850 Test Results

##### A. Test Verdict

Test Mode/ Channel	Frequency (MHz)	Frequency Range	Limit (dBm)	Verdict
GPRS 850 /128	824.20	150KHz -30MHz	-13.00	PASS
		30MHz -5GHz	-13.00	PASS
		5GHz-12GHz	-13.00	PASS
		12GHz-18GHz	-13.00	PASS
GPRS 850 /190	836.60	150KHz -30MHz	-13.00	PASS
		30MHz -5GHz	-13.00	PASS
		5GHz-12GHz	-13.00	PASS
		12GHz-18GHz	-13.00	PASS
GPRS 850 /251	848.80	150KHz -30MHz	-13.00	PASS
		30MHz -5GHz	-13.00	PASS
		5GHz-12GHz	-13.00	PASS
		12GHz-18GHz	-13.00	PASS

##### Note:

1. In general, the worse case attenuation requirement shown above was applied.
2. "----" means that the emission level is too low to be measured or at least 20 dB down than the limit.

##### B. Test Plots





Test Mode: GPRS

Test channel : 128

Test Mode: GPRS

Test channel : 190

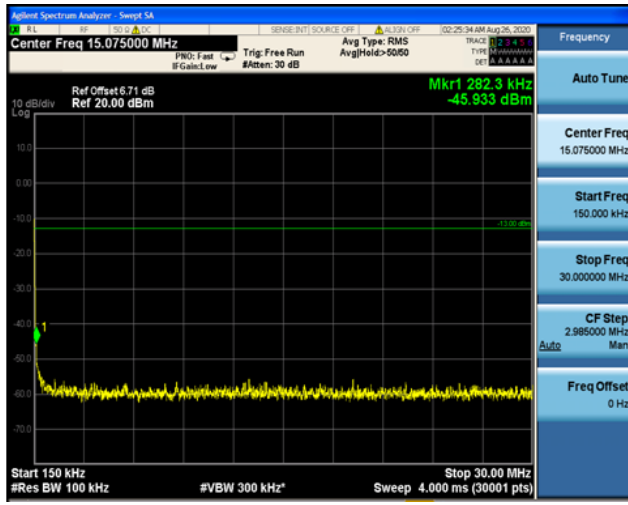

0.15~30MHz

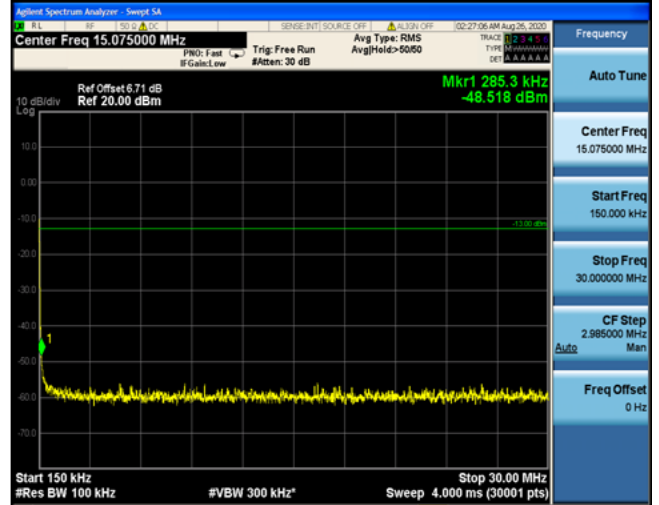

0.15~30MHz



1GHz ~5GHz

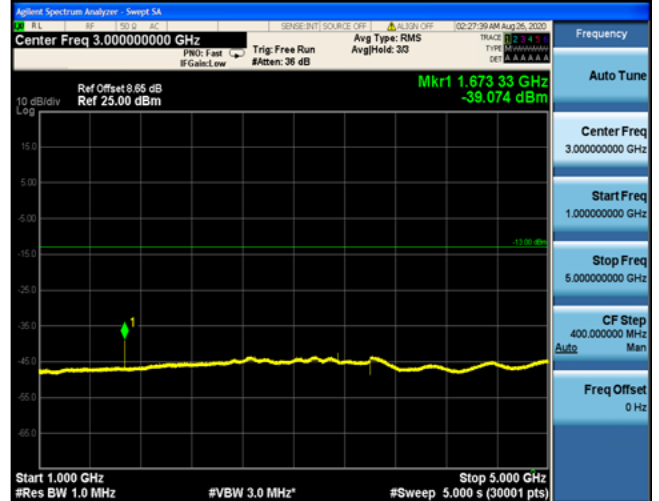

1GHz ~5GHz



5GHz ~12GHz

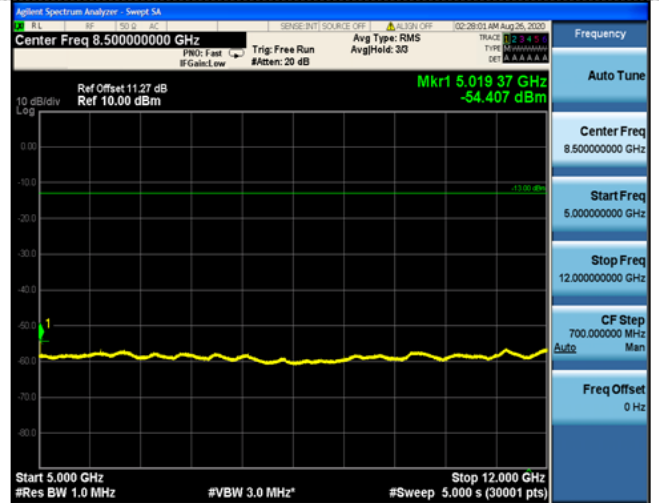

5GHz ~12GHz



12GHz ~18GHz



12GHz ~18GHz



Test Mode: GPRS

Test channel : 251

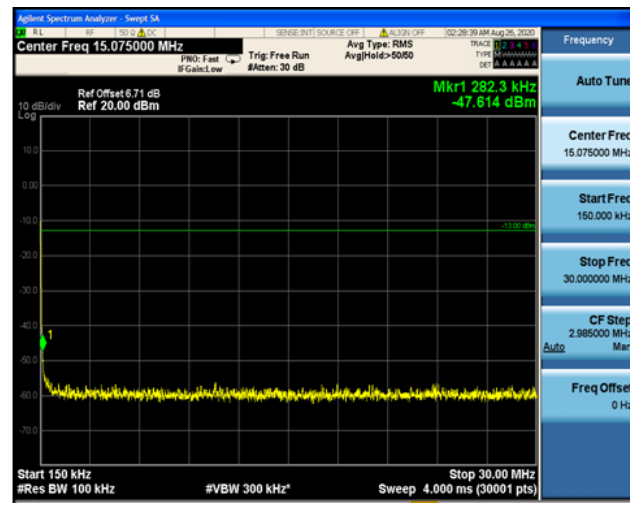

0.15~30MHz



1GHz~5GHz

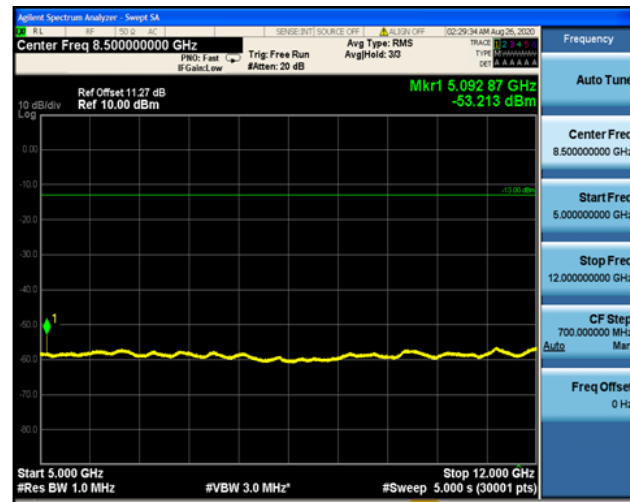

5GHz~12GHz



12GHz~18GHz



## 4.5.2 For GPRS 1900 Test Results

### A. Test Verdict

Test Mode/ Channel	Frequency (MHz)	Frequency Range	Limit (dBm)	Verdict
GPRS 1900 /512	1850.20	9KHz-150KHz	-13.00	PASS
		150KHz-30MHz	-13.00	PASS
		30MHz -1GHz	-13.00	PASS
		5GHz-12GHz	-13.00	PASS
		12GHz-26.5GHz	-13.00	PASS
GPRS 1900 /661	1880.00	9KHz-150KHz	-13.00	PASS
		150KHz-30MHz	-13.00	PASS
		30MHz -1GHz	-13.00	PASS
		5GHz-12GHz	-13.00	PASS
		12GHz-26.5GHz	-13.00	PASS
GPRS 1900 /810	1909.80	9KHz-150KHz	-13.00	PASS
		150KHz-30MHz	-13.00	PASS
		30MHz -1GHz	-13.00	PASS
		5GHz-12GHz	-13.00	PASS
		12GHz-26.5GHz	-13.00	PASS

#### Note:

1. In general, the worse case attenuation requirement shown above was applied.
2. "----" means that the emission level is too low to be measured or at least 20 dB down than the limit.

### B. Test Plots



Test Mode: GPRS

Test channel : 512

Test Mode: GPRS

Test channel : 661

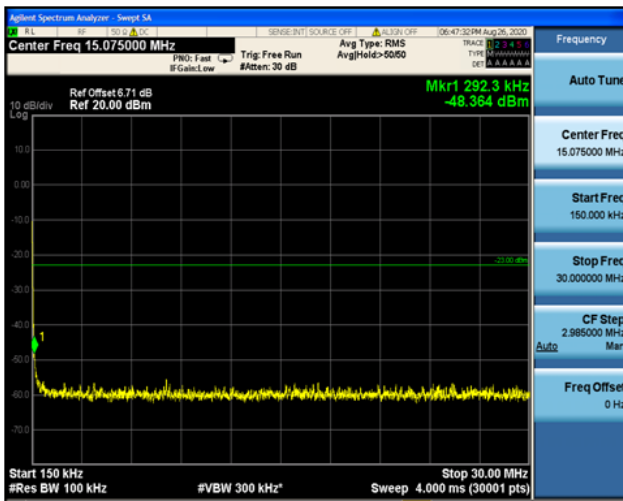

0.15~30MHz

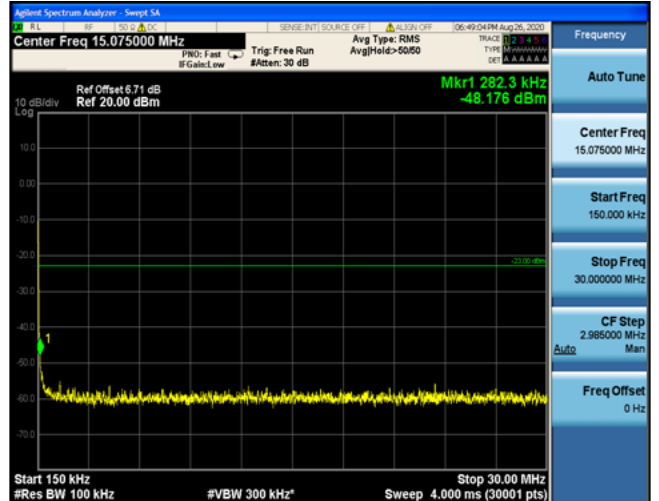

0.15~30MHz

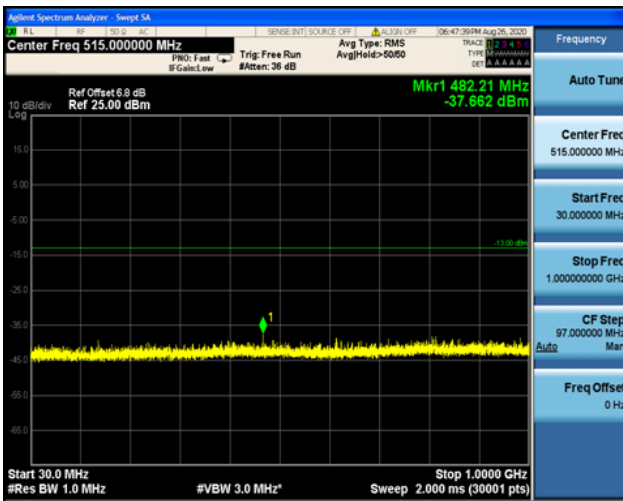

30MHz~1GHz

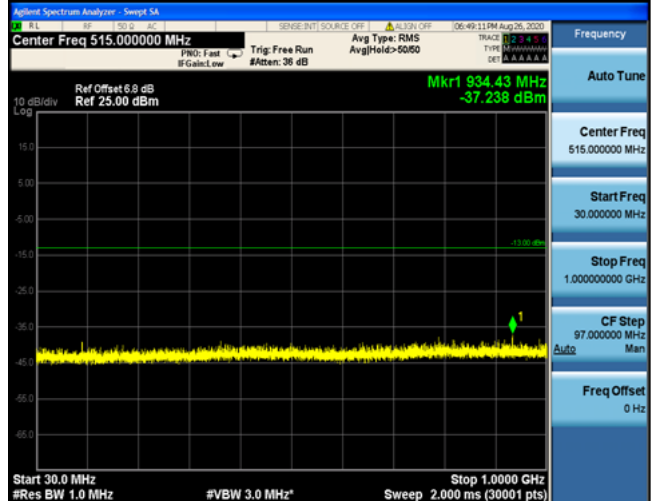

30MHz~1GHz

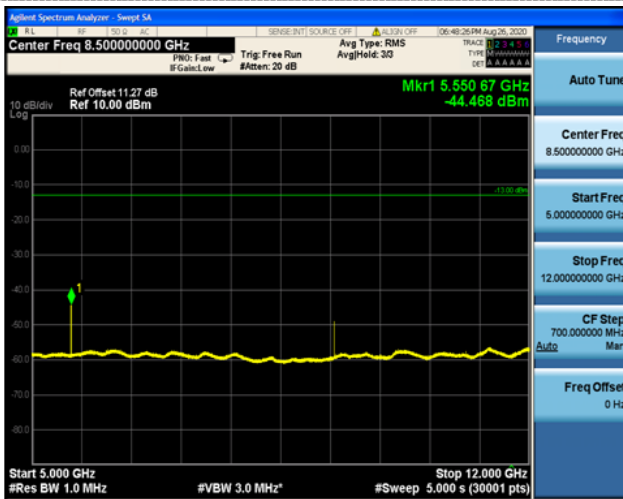

5GHz ~12GHz



5GHz ~12GHz

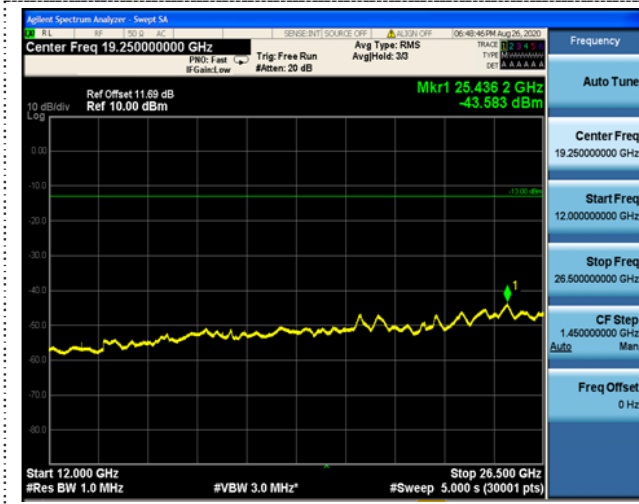

12GHz ~26.5GHz



12GHz ~26.5GHz



Test Mode: GPRS

Test channel : 810

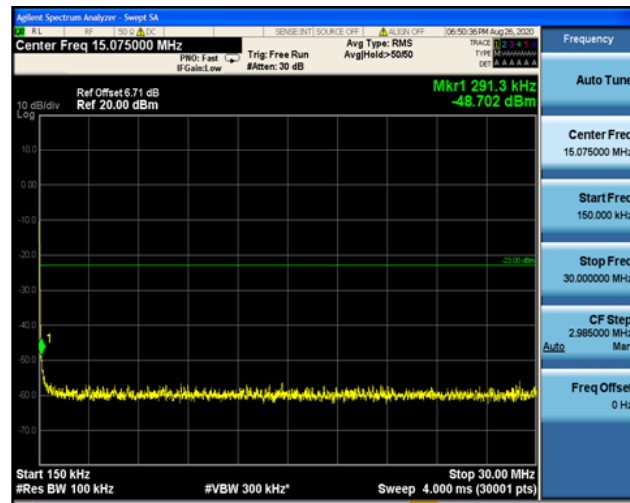

0.15~30MHz

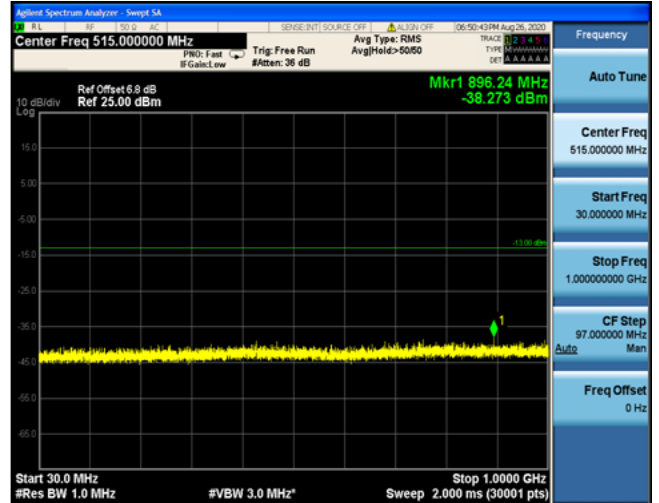

30MHz~1GHz

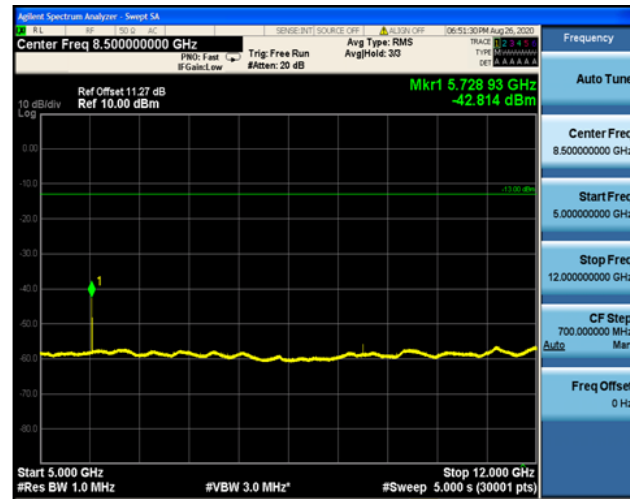

5GHz ~12GHz

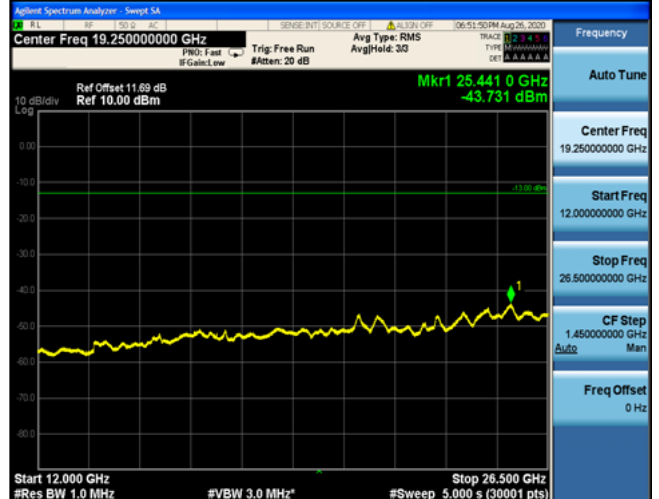

12GHz ~26.5GHz



## 4.6 Frequency Stability Test

### TEST APPLICABLE

1. According to FCC Part 2 Section 2.1055 (a)(1), the frequency stability shall be measured with variation of ambient temperature from  $-30^{\circ}\text{C}$  to  $+50^{\circ}\text{C}$  centigrade.
2. According to FCC Part 2 Section 2.1055 (E) (2), for battery powered equipment, the frequency stability shall be measured with reducing primary supply voltage to the battery operating end point, which is specified by the manufacture.
3. Vary primary supply voltage from 85 to 115 percent of the nominal value for other than hand carried voltage equipment and the end voltage point was 10.8V.

### TEST PROCEDURE

In order to measure the carrier frequency under the condition of AFC lock, it is necessary to make measurements with the EUT in a "call mode". This is accomplished with the use of R&S CMU200 DIGITAL RADIO COMMUNICATION TESTER.

1. Measure the carrier frequency at room temperature;
2. Subject the EUT to overnight soak at  $-30^{\circ}\text{C}$ ;
3. With the EUT, powered via nominal voltage, connected to the CMU200 and in a simulated call on middle channel of PCS 1900 and GSM850, measure the carrier frequency. These measurements should be made within 2 minutes of Powering up the EUT, to prevent significant self-warming;
4. Repeat the above measurements at  $10^{\circ}\text{C}$  increments from  $-30^{\circ}\text{C}$  to  $+50^{\circ}\text{C}$ . Allow at least 0.5 hours at each temperature, unpowered, before making measurements;
5. Remeasure carrier frequency at room temperature with nominal voltage. Vary supply voltage from minimum voltage to maximum voltage, in 0.1Volt increments remeasuring carrier frequency at each voltage. Pause at nominal voltage for 0.5 hours unpowered, to allow any self-heating to stabilize, before continuing;
6. Subject the EUT to overnight soak at  $+50^{\circ}\text{C}$ ;
7. With the EUT, powered via nominal voltage, connected to the CMU200 and in a simulated call on the centre channel, measure the carrier frequency. These measurements should be made within 2 minutes of Powering up the EUT, to prevent significant self-warming;
8. Repeat the above measurements at  $10^{\circ}\text{C}$  increments from  $+50^{\circ}\text{C}$  to  $-30^{\circ}\text{C}$ . Allow at least 0.5 hours at each temperature, unpowered, before making measurements;
9. At all temperature levels hold the temperature to  $\pm 0.5^{\circ}\text{C}$  during the measurement procedure;

### TEST CONFIGURATION

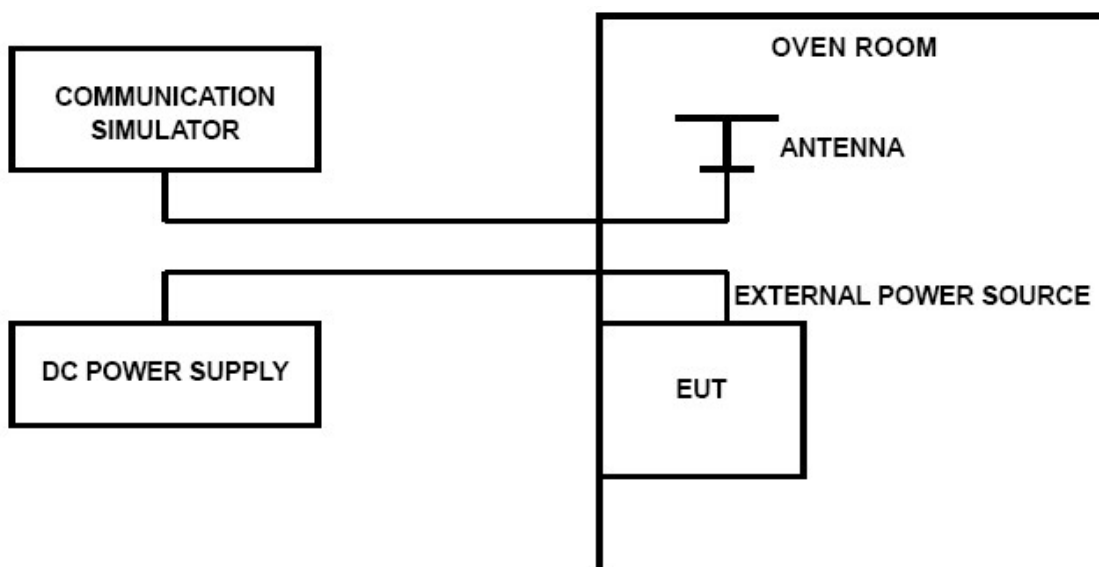





## TEST LIMITS

### ***For Hand carried battery powered equipment***

According to the JTC standard the frequency stability of the carrier shall be accurate to within 0.1 ppm of the received frequency from the base station. This accuracy is sufficient to meet Sec. 24.235, Frequency Stability. The frequency stability shall be sufficient to ensure that the fundamental emission stays within the authorized frequency block. As this transceiver is considered "Hand carried, battery powered equipment" Section 2.1055(d)(2) applies. This requires that the lower voltage for frequency stability testing be specified by the manufacturer. This transceiver is specified to operate with an input voltage of between 3.40VDC and 4.20VDC, with a nominal voltage of 3.80 DC. Operation above or below these voltage limits is prohibited by transceiver software in order to prevent improper operation as well as to protect components from overstress. These voltages represent a tolerance of -10 % and +12.5 %. For the purposes of measuring frequency stability these voltage limits are to be used.

### ***For equipment powered by primary supply voltage***

According to the JTC standard the frequency stability of the carrier shall be accurate to within 0.1 ppm of the received frequency from the base station. This accuracy is sufficient to meet Sec. 24.235, Frequency Stability. The frequency stability shall be sufficient to ensure that the fundamental emission stays within the authorized frequency block. For this EUT section 2.1055(d)(1) applies. This requires varying primary supply voltage from 85 to 115 percent of the nominal value for other than hand carried battery equipment.

## TEST RESULTS

<b>GPRS 850 Middle channel=190 channel=836.6MHz</b>					
<b>DC Power</b>	<b>Temperature (°C)</b>	<b>Frequency error(Hz)</b>	<b>Frequency error(ppm)</b>	<b>Limit (ppm)</b>	<b>Verdict</b>
3.27V	25	15.63	0.018683	2.50	PASS
3.85V	25	16.47	0.019687	2.50	PASS
4.43V	25	16.98	0.020296	2.50	PASS
3.85V	-30	15.05	0.017989	2.50	PASS
3.85V	-20	20.02	0.023930	2.50	PASS
3.85V	-10	15.69	0.018754	2.50	PASS
3.85V	0	15.11	0.018061	2.50	PASS
3.85V	10	17.24	0.020607	2.50	PASS
3.85V	20	18.02	0.021540	2.50	PASS
3.85V	30	16.34	0.019531	2.50	PASS
3.85V	40	15.82	0.018910	2.50	PASS
3.85V	50	16.40	0.019603	2.50	PASS

<b>GPRS 1900 Middle channel=661 channel=1880MHz</b>					
<b>DC Power</b>	<b>Temperature (°C)</b>	<b>Frequency error(Hz)</b>	<b>Frequency error(ppm)</b>	<b>Limit (ppm)</b>	<b>Verdict</b>
3.27V	25	24.41	0.012984	2.50	PASS
3.85V	25	29.44	0.015660	2.50	PASS
4.43V	25	26.86	0.014287	2.50	PASS
3.85V	-30	27.89	0.014835	2.50	PASS
3.85V	-20	25.18	0.013394	2.50	PASS
3.85V	-10	25.76	0.013702	2.50	PASS
3.85V	0	23.44	0.012468	2.50	PASS
3.85V	10	23.12	0.012298	2.50	PASS
3.85V	20	24.15	0.012846	2.50	PASS
3.85V	30	21.95	0.011676	2.50	PASS
3.85V	40	22.08	0.011745	2.50	PASS
3.85V	50	23.57	0.012537	2.50	PASS



GSM 850 Middle channel=190 channel=836.6MHz					
DC Power	Temperature (°C)	Frequency error(Hz)	Frequency error(ppm)	Limit (ppm)	Verdict
3.27V	25	16.59	0.019830	2.50	PASS
3.85V	25	16.92	0.020225	2.50	PASS
4.43V	25	18.98	0.022687	2.50	PASS
3.85V	-30	17.37	0.020763	2.50	PASS
3.85V	-20	17.31	0.020691	2.50	PASS
3.85V	-10	17.76	0.021229	2.50	PASS
3.85V	0	21.24	0.025388	2.50	PASS
3.85V	10	16.08	0.019221	2.50	PASS
3.85V	20	16.40	0.019603	2.50	PASS
3.85V	30	16.92	0.020225	2.50	PASS
3.85V	40	15.88	0.018982	2.50	PASS
3.85V	50	16.98	0.020296	2.50	PASS

GSM 1900 Middle channel=661 channel=1880MHz					
DC Power	Temperature (°C)	Frequency error(Hz)	Frequency error(ppm)	Limit (ppm)	Verdict
3.27V	25	27.89	0.014835	2.50	PASS
3.85V	25	25.18	0.013394	2.50	PASS
4.43V	25	25.76	0.013702	2.50	PASS
3.85V	-30	23.44	0.012468	2.50	PASS
3.85V	-20	23.12	0.012298	2.50	PASS
3.85V	-10	24.15	0.012846	2.50	PASS
3.85V	0	21.95	0.011676	2.50	PASS
3.85V	10	22.08	0.011745	2.50	PASS
3.85V	20	23.57	0.012537	2.50	PASS
3.85V	30	27.89	0.014835	2.50	PASS
3.85V	40	25.18	0.013394	2.50	PASS
3.85V	50	25.76	0.013702	2.50	PASS



EGPRS 850 Middle channel=190 channel=836.6MHz					
DC Power	Temperature (°C)	Frequency error(Hz)	Frequency error(ppm)	Limit (ppm)	Verdict
3.27V	25	10.23	0.012228	2.50	PASS
3.85V	25	8.01	0.009574	2.50	PASS
4.43V	25	8.68	0.010375	2.50	PASS
3.85V	-30	8.20	0.009802	2.50	PASS
3.85V	-20	0.16	0.000191	2.50	PASS
3.85V	-10	-4.07	-0.004865	2.50	PASS
3.85V	0	-1.45	-0.001733	2.50	PASS
3.85V	10	-2.71	-0.003239	2.50	PASS
3.85V	20	-2.20	-0.002630	2.50	PASS
3.85V	30	0.06	0.000072	2.50	PASS
3.85V	40	-1.81	-0.002164	2.50	PASS
3.85V	50	-0.06	-0.000072	2.50	PASS

EGPRS 1900 Middle channel=661 channel=1880MHz					
DC Power	Temperature (°C)	Frequency error(Hz)	Frequency error(ppm)	Limit (ppm)	Verdict
3.27V	25	21.05	0.011197	2.50	PASS
3.85V	25	19.47	0.010356	2.50	PASS
4.43V	25	22.47	0.011952	2.50	PASS
3.85V	-30	22.92	0.012191	2.50	PASS
3.85V	-20	20.53	0.010920	2.50	PASS
3.85V	-10	23.50	0.012500	2.50	PASS
3.85V	0	24.28	0.012915	2.50	PASS
3.85V	10	27.70	0.014734	2.50	PASS
3.85V	20	31.25	0.016622	2.50	PASS
3.85V	30	28.35	0.015080	2.50	PASS
3.85V	40	24.73	0.013154	2.50	PASS
3.85V	50	30.22	0.016074	2.50	PASS

### 4.7 Peak-to-Average Ratio (PAR)

**LIMIT**

The Peak-to-Average Ratio (PAR) of the transmission may not exceed 13 dB.

**TEST CONFIGURATION**

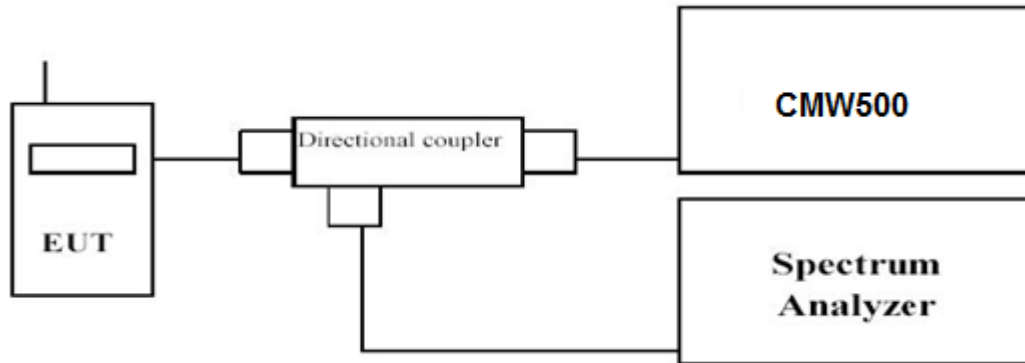

**TEST PROCEDURE**

Use spectrum to measure the total peak power and record as P<sub>Pk</sub>. Use spectrum to measure the total average power and record as P<sub>Avg</sub>. Both the peak and average power levels must be expressed in the same logarithmic units (e.g., dBm).

Determine the PAPR from:  
 $PAPR (dB) = P_{Pk} (dBm) - P_{Avg} (dBm)$ .

**TEST RESULTS**

**Note:**We tested EGPRS/GPRS/GSM mode and recorded the worst case at the GPRS mode.

GPRS 850			
Frequency (MHz)	Peak power	AV power	Measured (dB)
824.20	35.47	32.87	2.60
836.60	35.48	32.87	2.61
848.80	35.47	32.87	2.60

GPRS 1900			
Frequency (MHz)	Peak power	AV power	Measured (dB)
1850.20	32.35	29.74	2.61
1880.00	32.31	29.70	2.60
1909.80	32.17	29.56	2.61

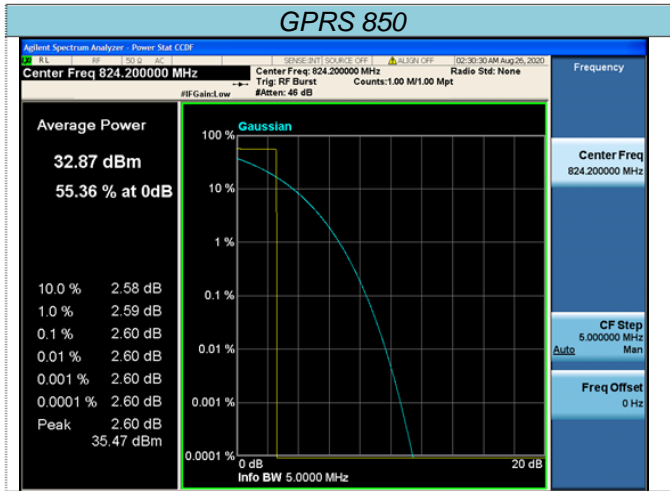

Channel 128

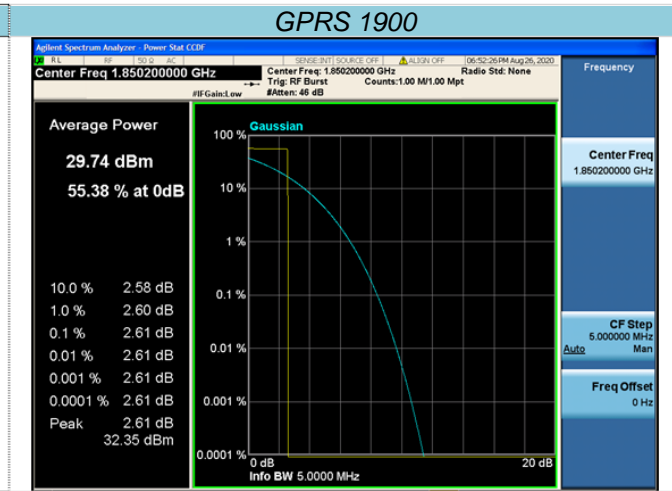

Channel 512

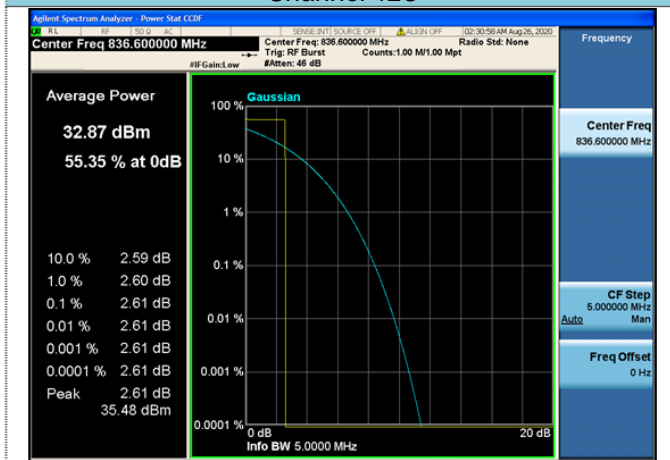

Channel 190

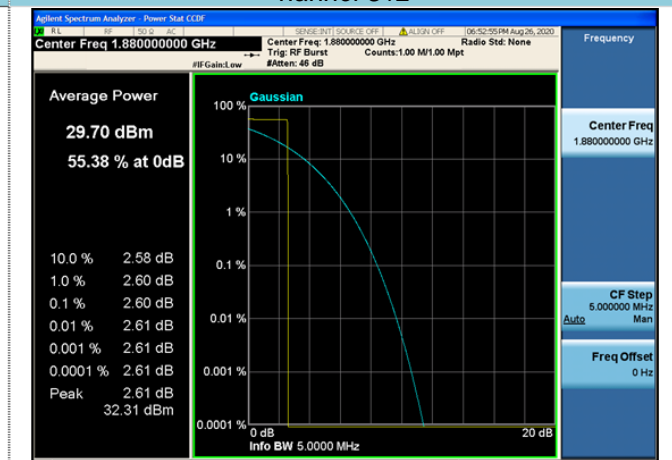

Channel 661

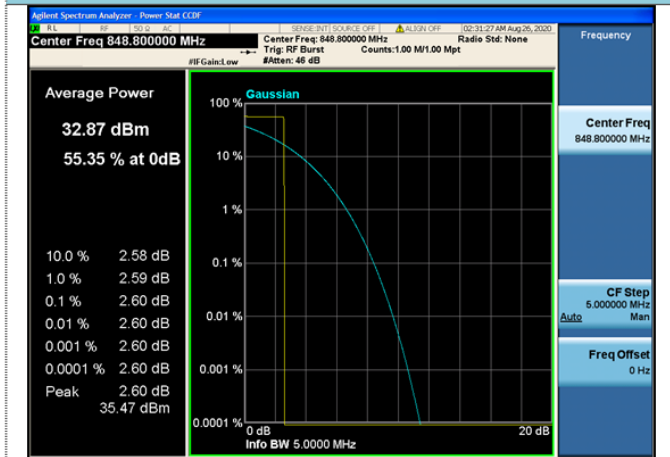

Channel 251



Channel 810

## 5 Test Setup Photos of the EUT

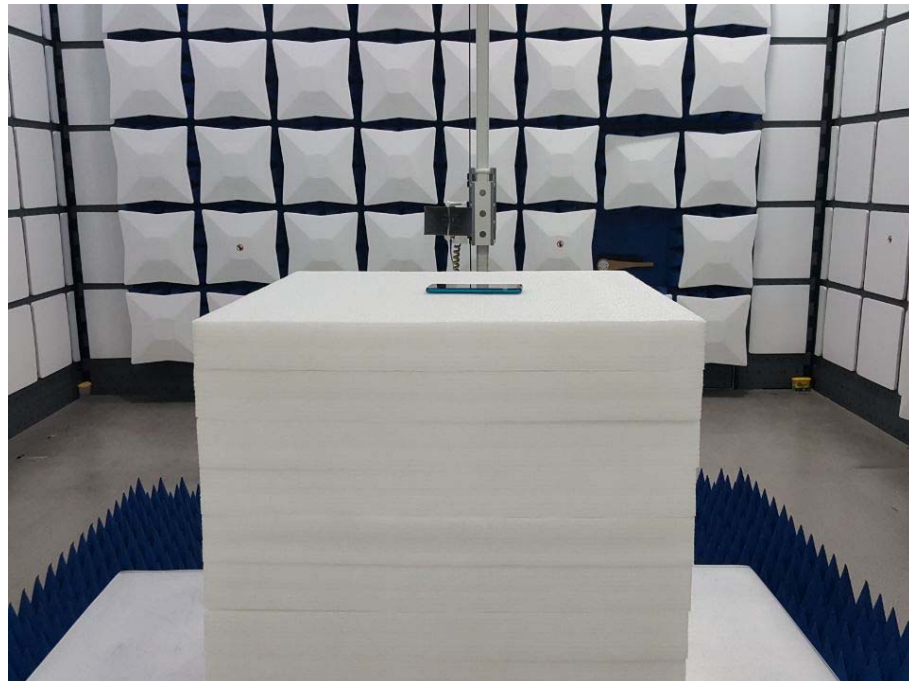
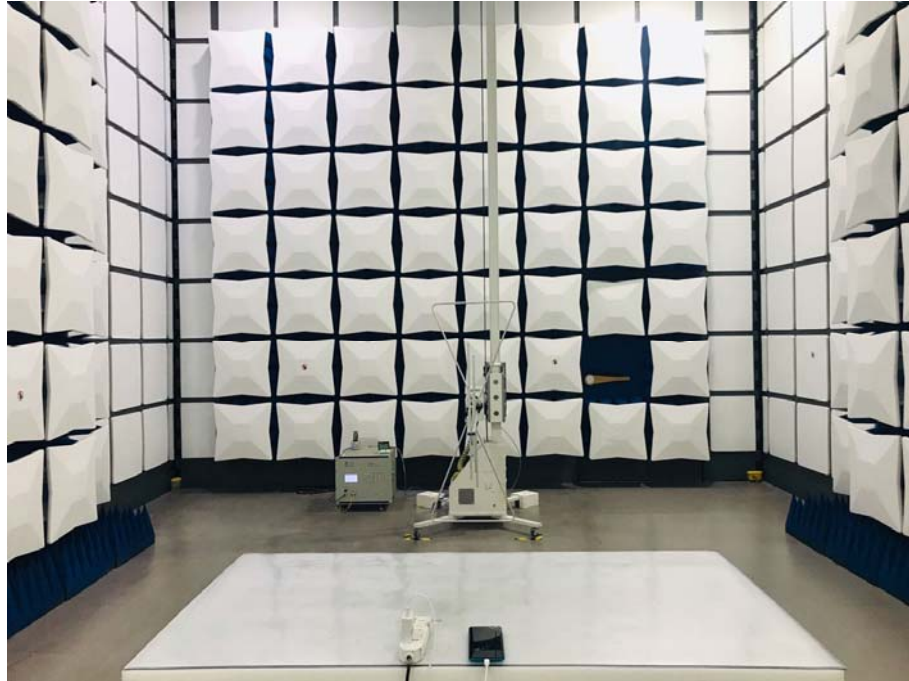

.....End of Report.....