

Nameplate type 1:
Approval
Bluetooth approval
Metal TAG

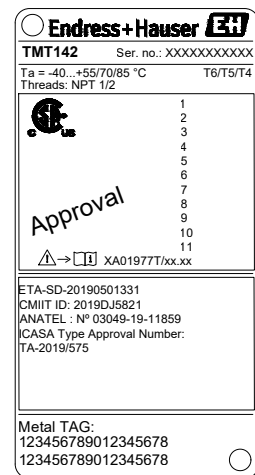

Additional attached nameplate at housing
Erweitertes, angehängtes Typenschild an das Gehäuse

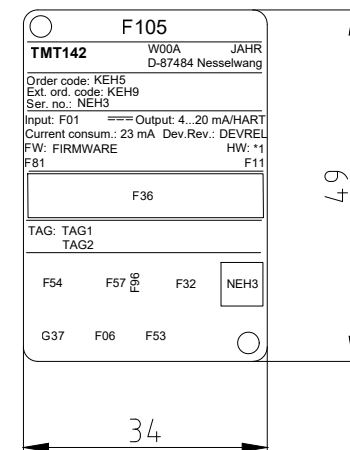
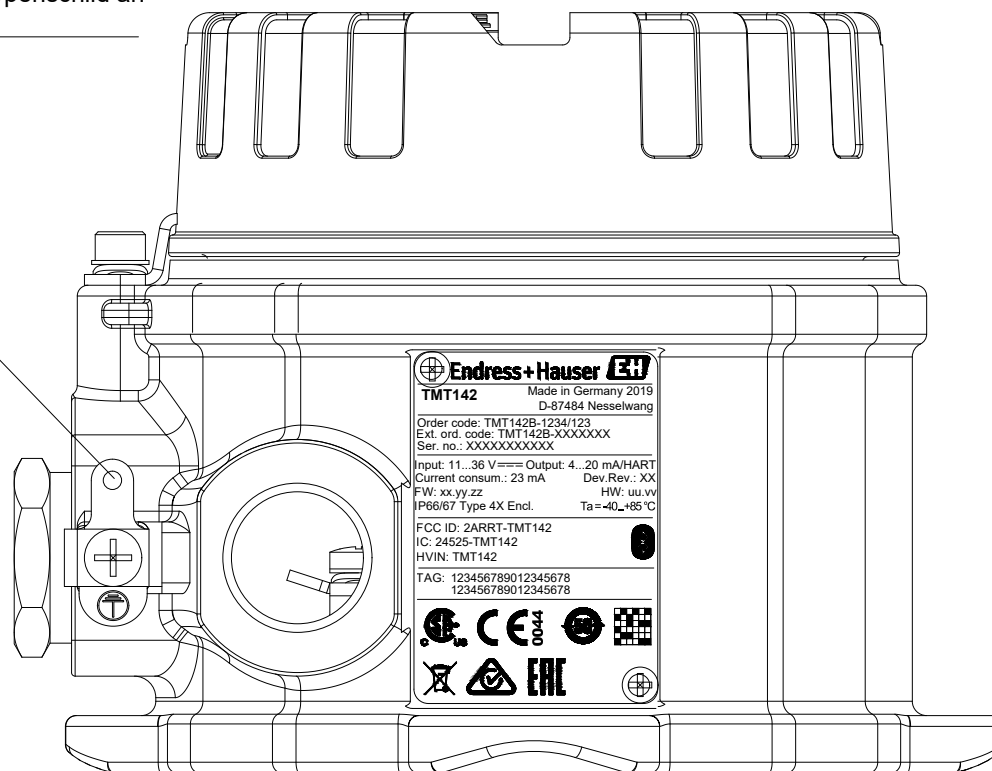
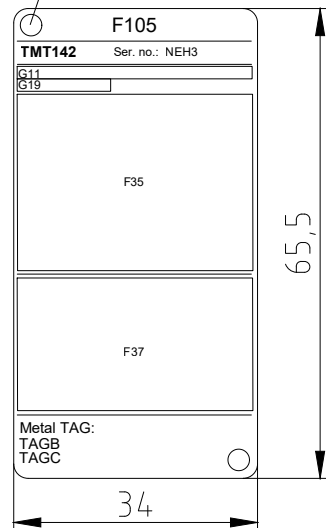

Nameplate type 2:
Bluetooth approval
Metal TAG

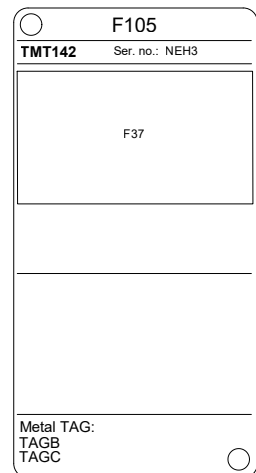
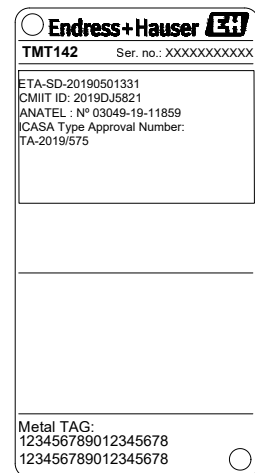

Nameplate type 3:
Metal TAG
non Ex,
without Bluetooth

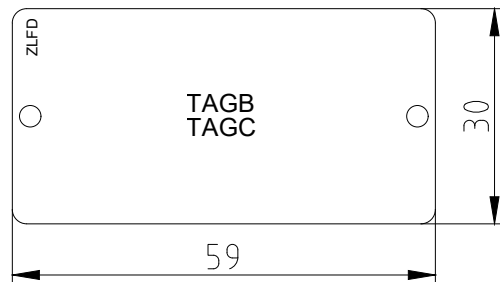
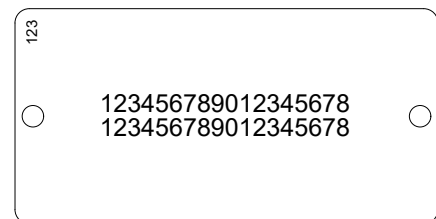

Metal TAG according to drawing 050000007

*1 = O_W_LAB_UNI_HARDWARE_WO_BUGFIX

Device according to RoHS Compliant

Endress+Hauser Endress+Hauser, Vetzler, GmbH+Co.KG Division Germany, 87484 Nesselwang	Refer to protection notice ISO 16016	Scale 1:1	Tolerance Geometrical tolerances ISO 2768-1 m/k (mittel)		
	Title TMT142B Nameplate Layout and position	Notif.No. 2052	Last editor 2020-01-22 WirtzE		
		Number of Changes B	Designed 2019-02-28 KoserT		
	Status Released	Approval contr. Released 2020-01-23 BriechleB	No. of document NPL000340-XXXXX	Version B	Document part 000
Classification Internal	Unit TMT142B	Weight without	SAP material no. without	Volume DIN A3	Page 1/1

ISO 8015
 ISO 14405
 TOLERANCING ACC. TO DIMENSIONS
 DIN EN ISO 1101
 DIN EN ISO 1302
 DIN ISO 13715
 GEOMETRICAL TOLERANCING SURFACE TEXTURE EDGES OF WORKING PARTS