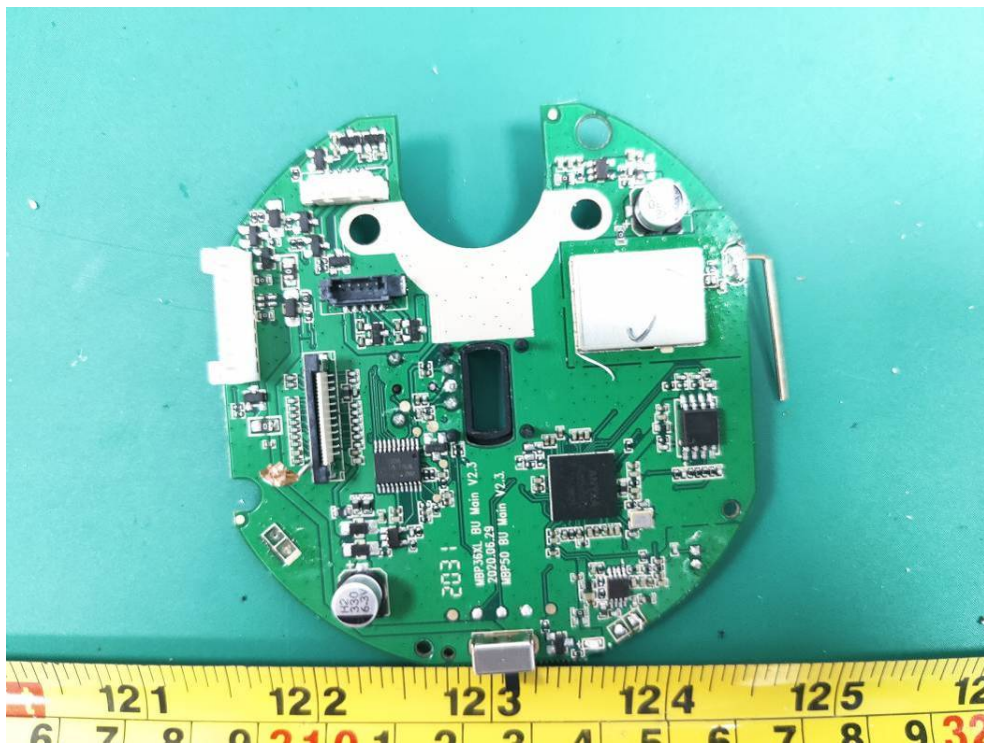
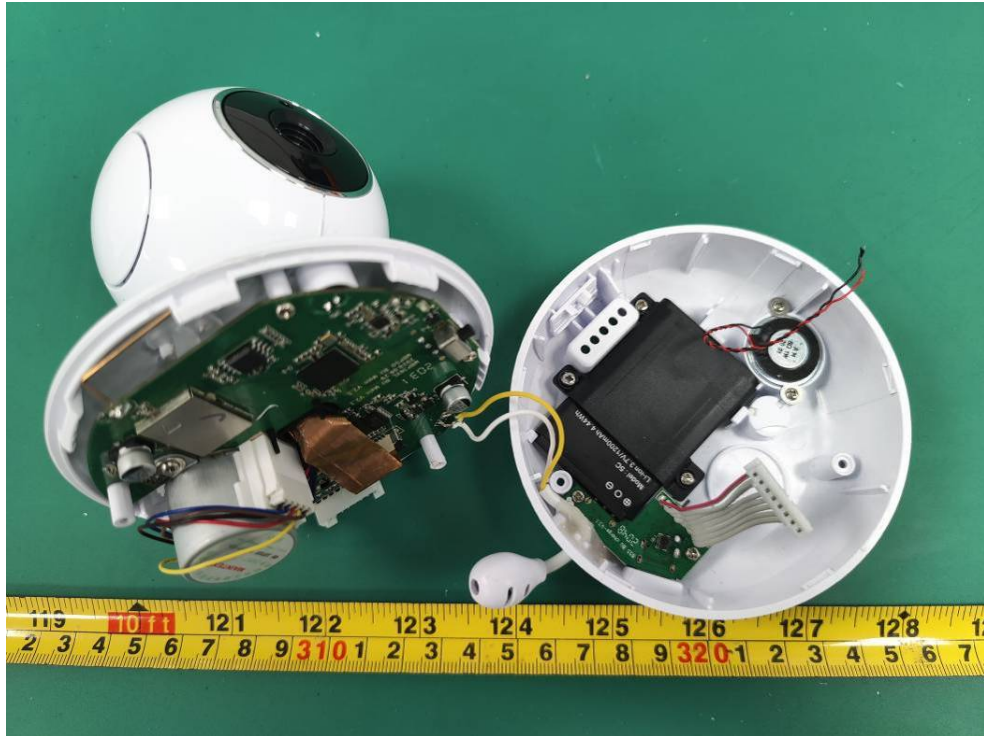
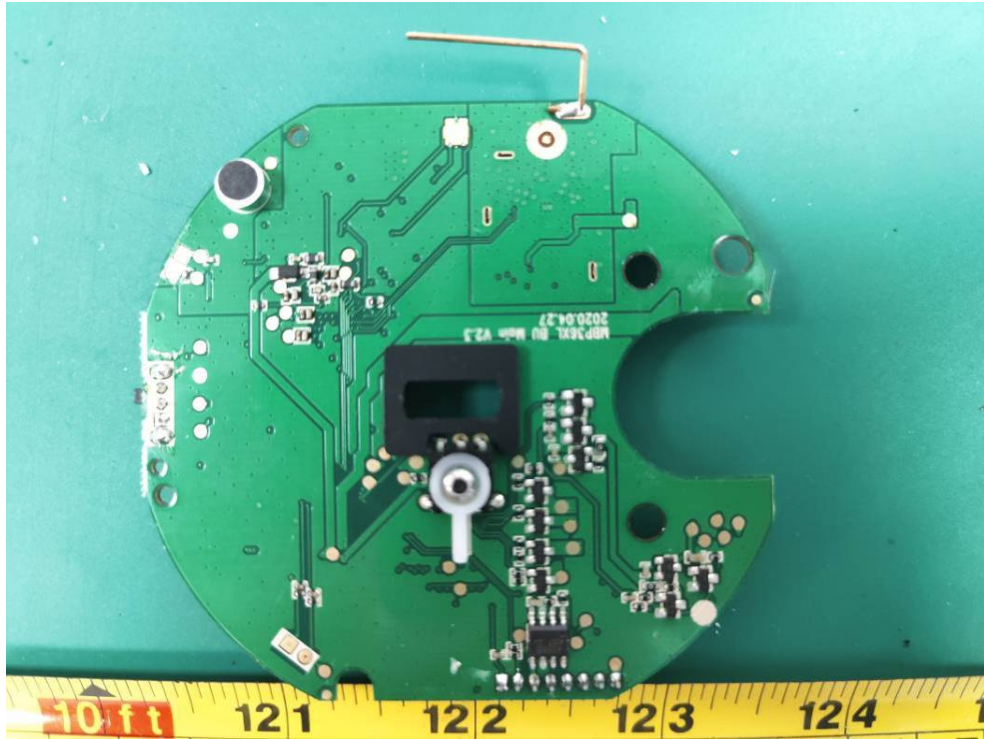

**EXHIBIT C - EUT INTERNAL PHOTOGRAPHS**

Test Model: VM36XLBU





ANT

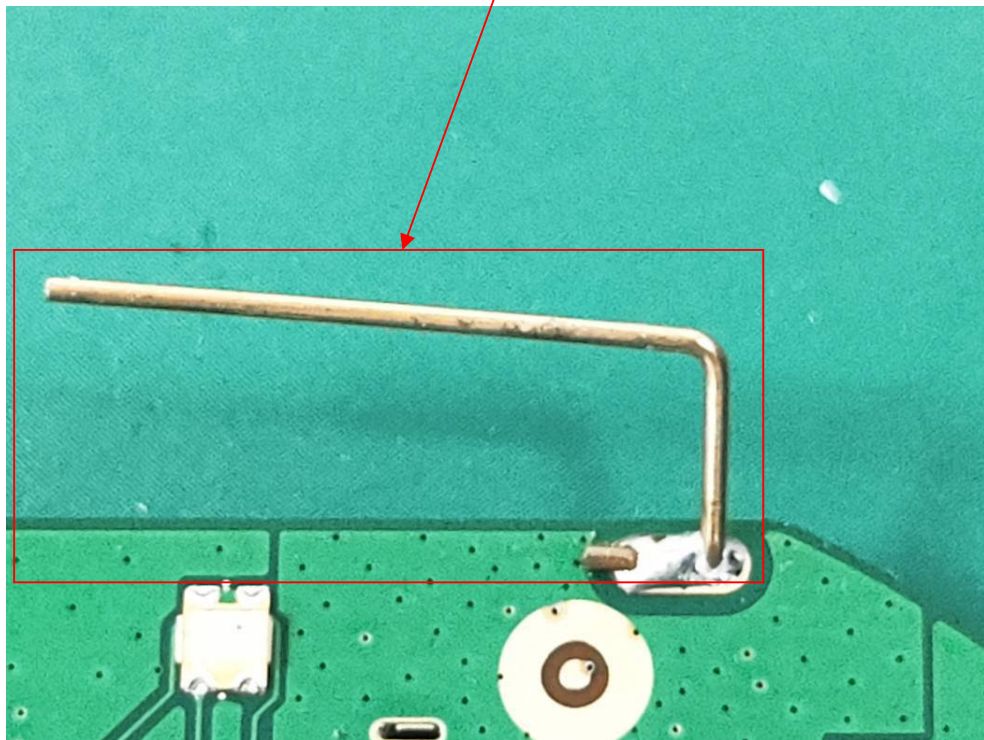



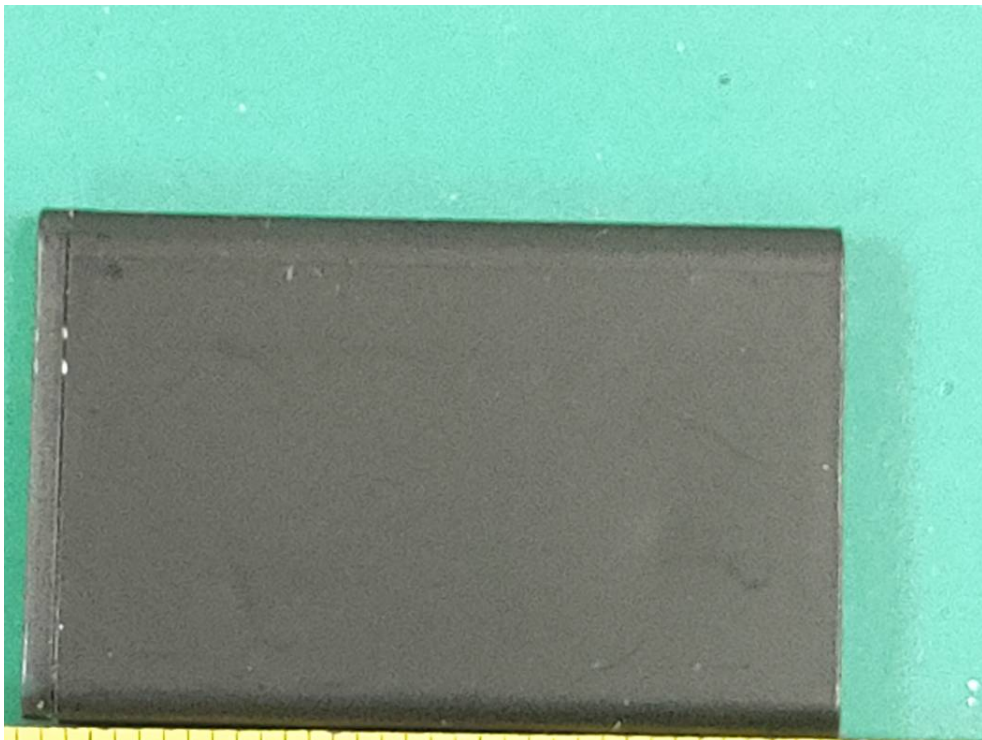
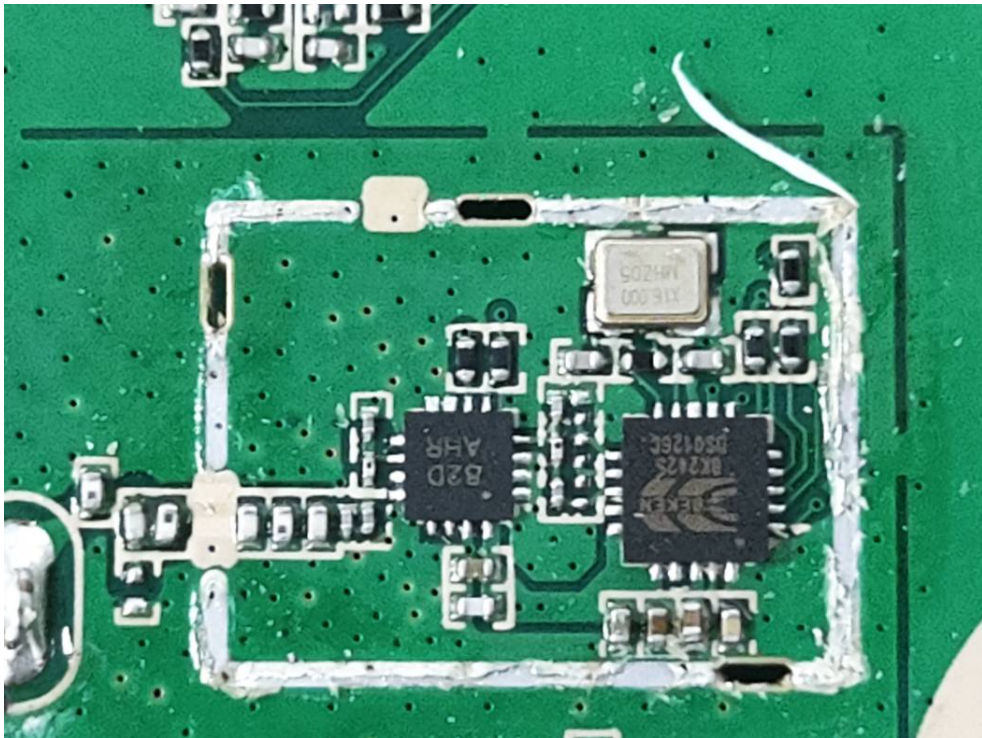

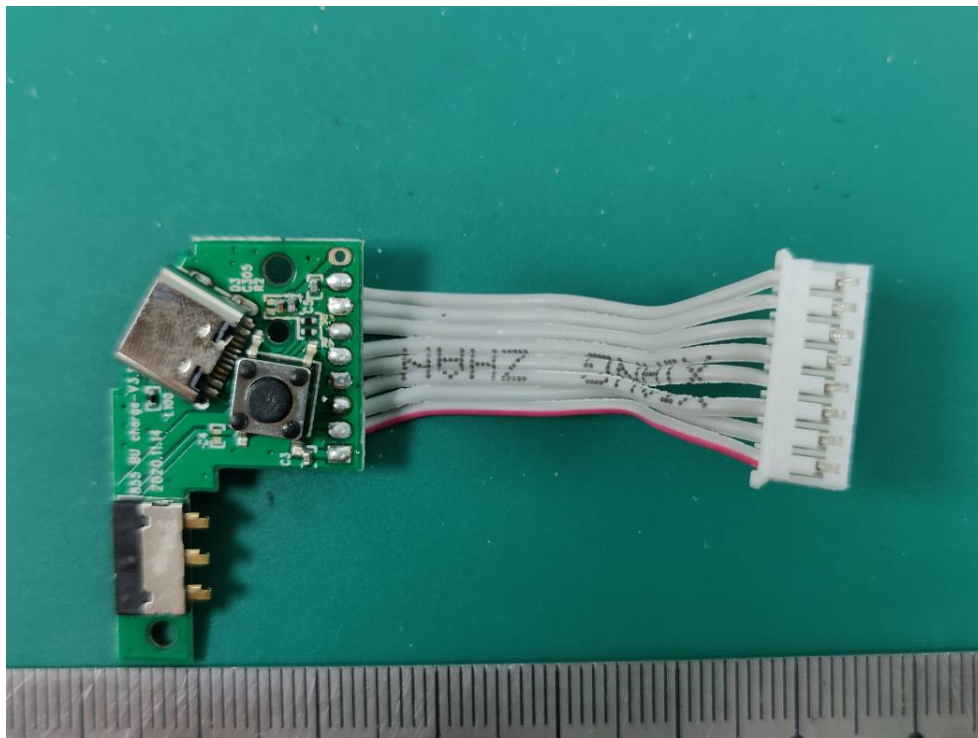



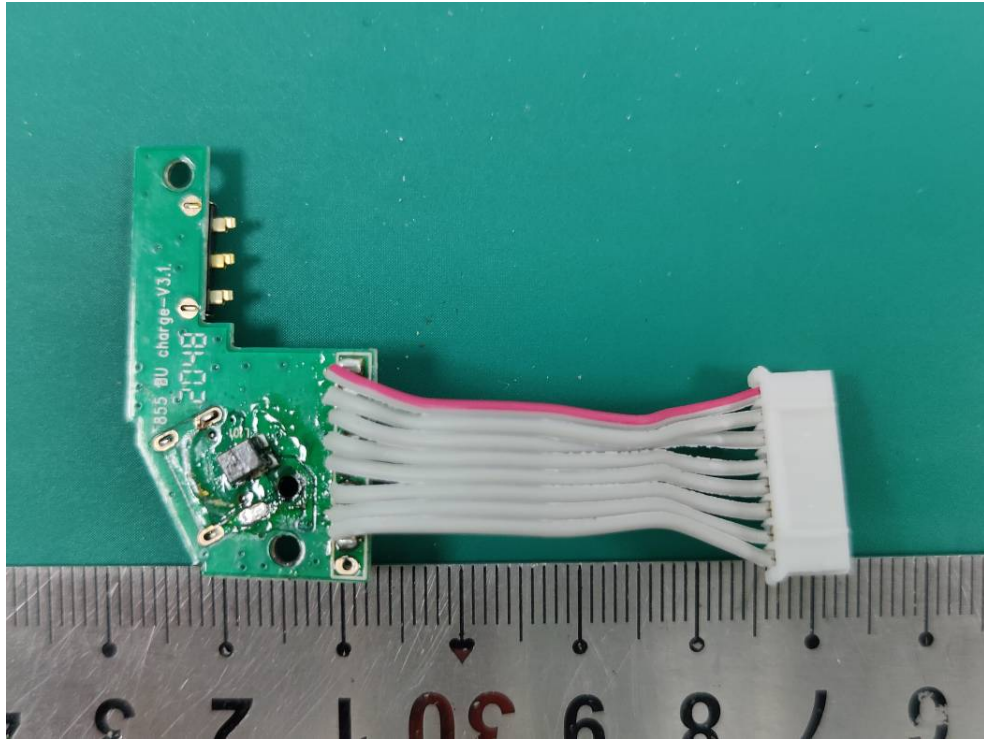

Multiple Model: VM50ABU

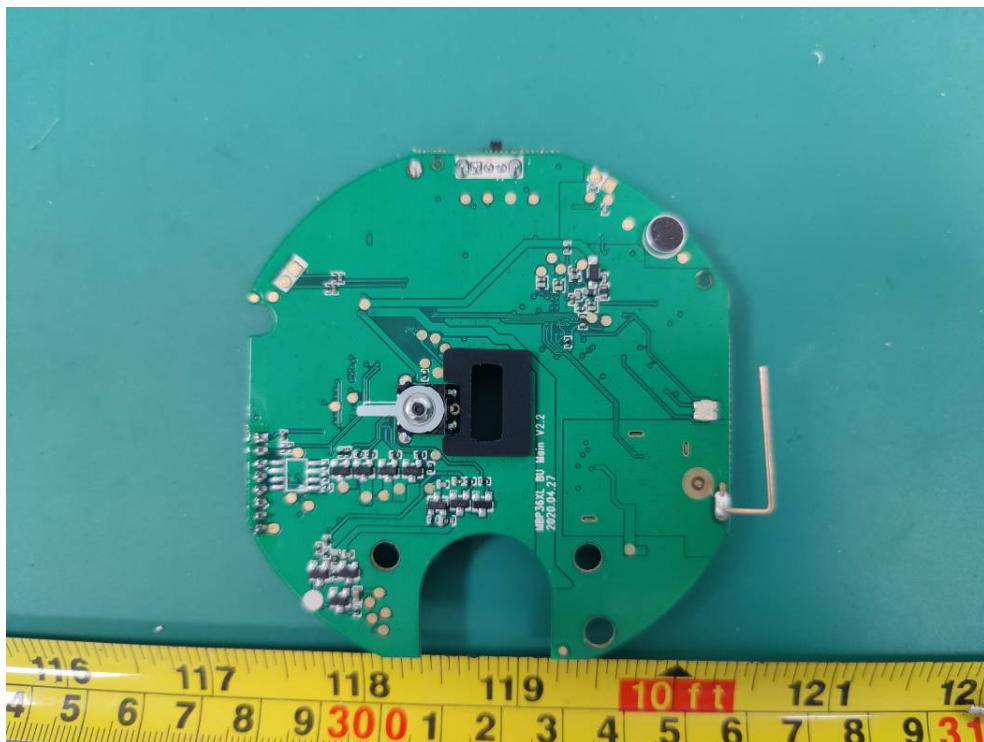

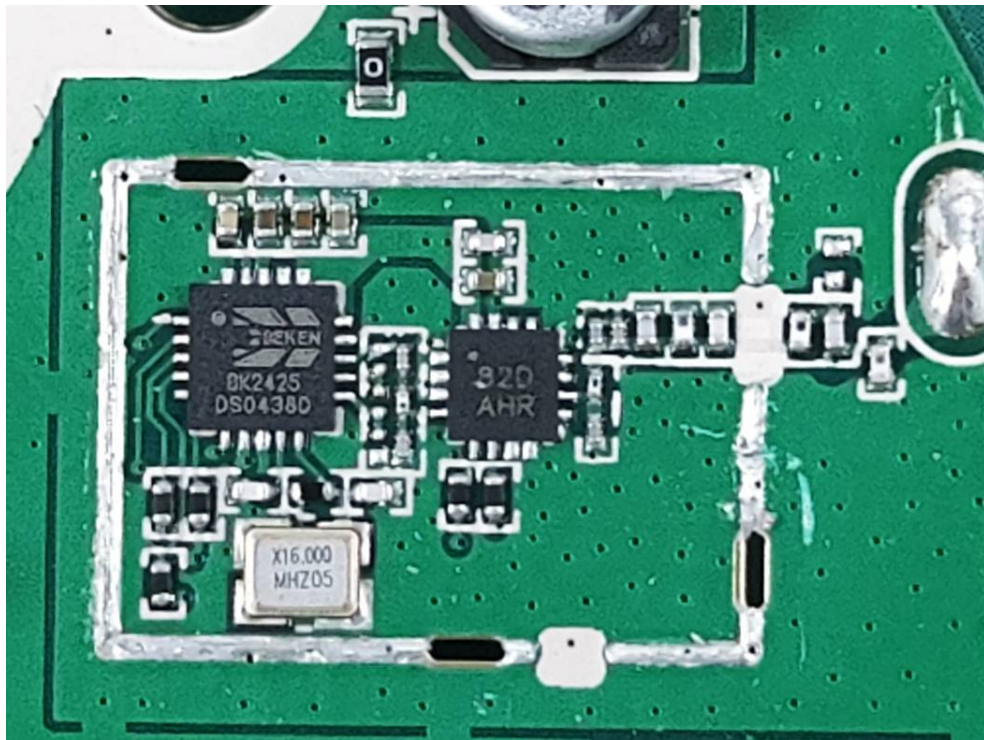
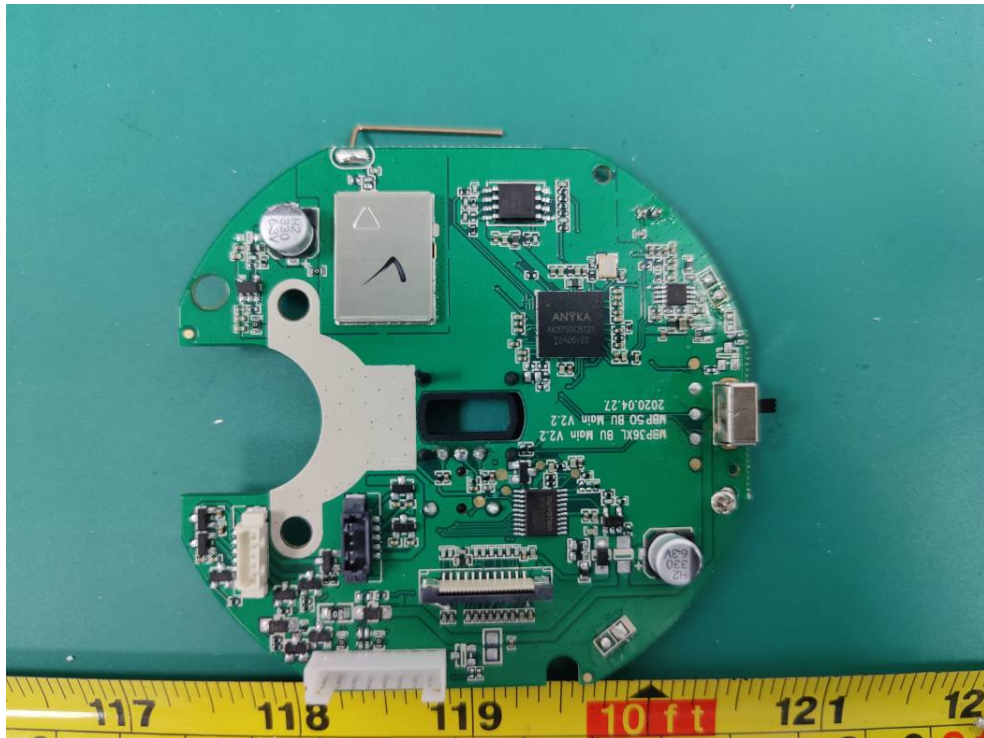



ANT

