

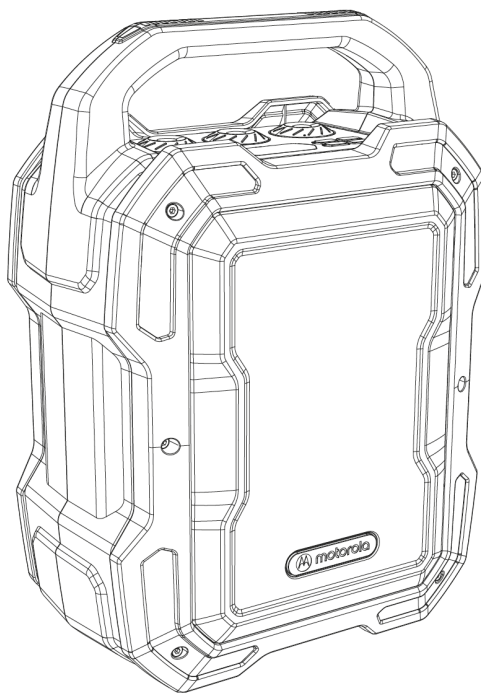

motorola

Bluetooth Party Speaker / Bluetooth partyluidspreker / Haut-parleur Bluetooth Party / Bluetooth-Party-Lautsprecher / Reproduktor Bluetooth Party / Altavoz para fiesta Bluetooth / Altoparlante per feste Bluetooth / Bluetooth party-højttaler / Coluna Bluetooth para Festas / Bluetooth partyhögtalare / Głośnik imprezowy Bluetooth / Reproduktor s rádiem a Bluetooth / Haut-parleur pour les fêtes Bluetooth



For model: ROKR 800 / Voor model: ROKR 800 / Pour le modèle : ROKR 800 / Für Modell: ROKR 800 / Pre model: ROKR 800 / Para el modelo: ROKR 800 / Per modello: ROKR 800 / For model: ROKR 800 / Para o modelo: ROKR 800 / För modell: ROKR 800 / Dla modelu: ROKR 800 / Pro model: ROKR 800

Quick start guide / Snelstartgids / Guide de démarrage rapide / Schnellstartanleitung / Stručná příručka / Guia de inicio rápido / Guida rapida / Hurtigstart-guide / Guia de iniciação rápida / Snabbstartsguide / Skrócona instrukcja obsługi / Rychlý návod





1. Introduction

Congratulations on your purchase! This manual includes information about “ROKR 800” Bluetooth Party Speaker. We encourage you to take a few minutes to read this manual, which describes the product and includes step-by-step instructions to help you set up and get started. Read and understand all the safety instructions before using your product.

2. What's in the box

- 1. Main unit
- 2. USB charging cable
- 3. Aux cable
- 4. Quick start guide

3. Product Overview

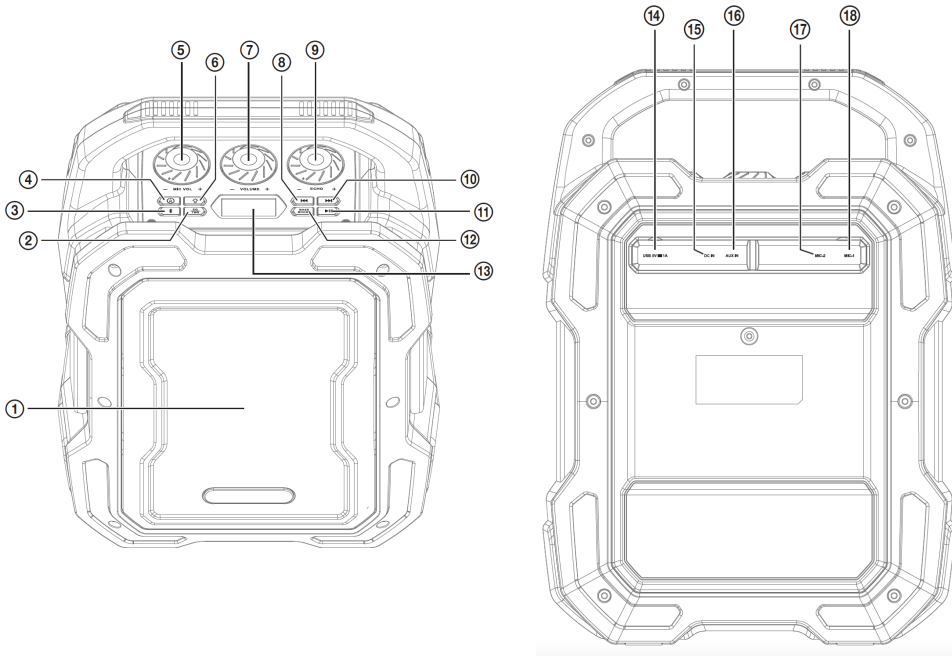



1) Speaker	10) Skip +
2) EQ button	11) Play/Pause
3) Bluetooth button	12) Bass Boost
4) Power / Mode button	13) LED display
5) Mic volume -/+ knob	14) USB port
6) Light control button	15) DC jack
7) Volume -/+ control knob	16) Aux in jack
8) Skip-	17) Mic 2 jack
9) Echo -/+	18) Mic 1 jack





4. Power on/Power off/Charging

1. Connect one end of the charging cable to the speaker's DC jack and the other end to an external DC 5V/2A power source. It takes about 2-3 hours to fully charge the speaker.
2. Press and hold  for 3 seconds to power on the speaker.
3. Press and hold  for 3 seconds to power off the speaker.
4. You can use this speaker as a battery charger for your rechargeable USB devices. Connect your USB device to the USB port on the rear of this speaker.

The speaker is operated by connecting it to the built-in rechargeable battery. After the speaker is powered on, the battery level will be shown on the LED display and you can check the status on the display.



Note

The speaker will enter sleep mode after 15 minutes of inactivity.



- If the speaker is powered by the battery, it will automatically power off if no action is performed for 15 minutes.
- If the speaker is powered by the AC or DC power source, it will enter standby (off) mode if no action is performed for 15 minutes.

5. Bluetooth Connection







You can use your speaker "ROKR 800" as an external speaker for your Bluetooth enabled smartphone or tablet.

1. Press  or  to enter Bluetooth mode. To remove and forget the previous connections, press and hold .
2. Choose "ROKR 800" on your mobile device to connect to the speaker.
3. Once a successful connection is established, you can start streaming audio from your Bluetooth device to this speaker.

6. USB Connection

With your speaker, you can enjoy music stored in a USB storage device such as an MP3 player. Connect your USB storage device to the USB port of your speaker. Music will play automatically. Otherwise, press  to select USB mode and press  on the speaker. Make sure the USB device contains playable audio contents.

7. FM Radio

1. Press  to select FM radio mode.
2. Auto tuning: Press and hold  on the speaker for 3 seconds until the frequency indication starts to change, then release the button. The speaker will search and store the stations. A maximum of 30 stations can be stored.
3. Manual tuning: Press  /  to manually select the desired FM frequency.
4. Select the stored stations: Press , the display will show the number of the stored stations, then press  /  to select the number of the station.

8. AUX Connection

1. Press  to select AUX mode.
2. Connect one end of a 3.5mm audio cable to the headphone or audio line-out socket of your audio device and the other end to the AUX in jack of this speaker.
3. Turn on your audio device and audio starts playing from the device.

9. EQ mode and Bass Boost

1. Press **EQ** to scroll through five different EQ settings: **Flat** > **Rock** > **Jazz** > **Classic** > **Pop**.
2. Press  to get the super bass sound.
3. If Mic 1/Mic 2 is connected to the microphone, the EQ setting will turn off. Press **EQ** and the display will show: **VOCA, DUCI, EqOF**.





- **VOCA** (Vocal Cut): Vocals will be removed from the music/radio. You can speak or sing into the microphone.
- **DUCI** (Music Ducking): When you speak into the microphone, the volume level of the music/radio will be lowered.
- **EqOF**: EQ setting will turn off.

Note

This EQ mode only works when the speaker is in Bluetooth or USB mode, and it does not work when the speaker is in FM or AUX mode.

10. Light

1. Press and hold  to turn on or off the light.
 2. Select a LED mode to show different lighting effects (default setting: LED 1):
- Led-1: You will see the LED demo display if there is no music playback. If there is music detected, the LED colour flashes and changes in sync with the music.
 - Led-2: The LED colour flashes regularly and rhythmically.

11. Specification

Product name	Bluetooth speaker
DC power input	5V / 2A
Built-in battery	Li-ion 7.4V / 2550mAh
USB output	5V / 1A
Speaker drivers	6.5 inches driver & 1.5 inches tweeter
Speaker impedance	4 ohm
Total output power	20 W RMS
Signal to noise (S/N) ratio	71 dBA
FM frequency	87.5-108.0 MHz
Bluetooth version	BT 4.2
Bluetooth profile	A2DP, AVRCP
Bluetooth transmitter frequency range	2402 MHz - 2480 MHz
Bluetooth range	Approx. 10 m (33 feet)
USB format	FAT16, FAT32
USB file format	MP3, wma, wav
Dimension (W x H x D)	318 x 166 x 302 mm
Net weight	3.20 kg





EU regulatory conformance:

RF exposure information: The EIRP power of the device at maximal case is below the exempt condition, 20mW specified in EN62479: 2010. RF exposure assessment has been performed to prove that this unit will not generate the harmful EM emission above the reference level as specified in EC Council Recommendation(1999/519/EC).

Operation temperature: 0-45 °C

Operation frequency(Max power)

Bluetooth: 2402-2480 (-5 dBm)

FCC regulatory conformance:

This device complies with Part 15 of the FCC Rules. Operation is subject to the following two conditions:

- (1) This device may not cause harmful interference.
- (2) This device must accept any interference received, including interference that may cause undesired operation.

NOTE: This equipment has been tested and found to comply with the limits for a Class B digital device, pursuant to part 15 of the FCC Rules. These limits are designed to provide reasonable protection against harmful interference in a residential installation.

This equipment generates uses and can radiate radio frequency energy and, if not installed and used in accordance with the instructions, may cause harmful interference to radio communications. However, there is no guarantee that interference will not occur in a particular installation. If this equipment does cause harmful interference to radio or television reception, which can be determined by turning the equipment off and on, the user is encouraged to try to correct the interference by one or more of the following measures:

- Reorient or relocate the receiving antenna.
- Increase the separation between the equipment and receiver.
- Connect the equipment into an outlet on a circuit different from that to which the receiver is connected.
- Consult the dealer or an experienced radio/TV technician for help

NOTE: The manufacturer is not responsible for any radio or TV interference caused by unauthorized modifications to this equipment. Such modifications could void the user's authority to operate the equipment.

This equipment complies with FCC radiation exposure limits set forth for an uncontrolled environment.

IC regulatory conformance:

This device complies with CAN ICES-3 (B)/NMB-3(B).

This device complies with Industry Canada licence-exempt RSS standard(s). Operation is subject to the following two conditions:

- (1) this device may not cause harmful interference, and
- (2) this device must accept any interference received, including interference that may cause undesired operation.

Cet appareil est conforme à la norme CAN ICES-3 (B)/NMB-3 (B).

Le présent appareil est conforme aux CNR d'Industrie Canada applicables aux appareils radio exempts de licence. L'exploitation est autorisée aux deux conditions suivantes :

- (1) l'appareil ne doit pas produire de brouillage, et
- (2) l'utilisateur de l'appareil doit accepter tout brouillage radioélectrique subi, même si le brouillage est susceptible d'en compromettre le fonctionnement.

This equipment complies with IC radiation exposure limits set forth for an uncontrolled environment.

Cet équipement est conforme aux limites d'exposition aux radiations de la IC définies pour un environnement non contrôlé.

