

# motorola nursery

5.0" Wi-Fi® HD Video Baby Monitor with  
Touch Screen



**For: PIP1700 HD TOUCH CONNECT  
PIP1700-2 HD TOUCH CONNECT  
PIP1700-3 HD TOUCH CONNECT  
PIP1700-4 HD TOUCH CONNECT**

User Guide

**Important Notes:**

Charge the parent unit of PIP1700 HD TOUCH CONNECT for 16 hours before use.

## Safety instructions

# **WARNING**

Strangulation Hazard. Children have STRANGLED in cords. Keep this cord out of the reach of children (more than 1 metre away). Never use extension cords with AC Adapters. Only use the AC Adapters provided.



## **Baby monitor setup and use:**

- Choose a location for the baby unit that will provide the best view of your baby in their crib.
- Place the baby unit on a flat surface, such as a dresser, desk, shelf or wall mount the unit securely with the wall mount bracket provided in the pack.
- NEVER place the baby unit or cords in the crib or within reach of the baby (the unit and cords should be more than 3 feet away).

## **WARNING**

This Smart Video Baby Monitor is compliant with all relevant standards regarding electromagnetic fields and is, when handled as described in the User Guide, safe to use. Therefore, always read the instructions in this User Guide carefully before using the device.

- Adult assembly is required. Keep small parts away from children when assembling.
- This product is not a toy. Do not allow children to play with it.
- This baby monitor is not a substitute for responsible adult supervision.
- Keep this User Guide for future reference.
- Do not place the baby (camera) unit or cords in the crib or within reach of the baby (the unit and cords should be more than 3 feet away).
- Keep the cords out of reach of children.
- Do not cover the baby monitor with a towel, blanket, or other item that will stop air circulation.
- Never use extension cords with power adapters. Only use the power adapters provided.
- Test this monitor and all its functions so that you are familiar with it prior to actual use.
- Do not use the baby monitor near water or allow water or other foreign substances to enter the power port or adapter.
- Do not place the Baby Monitor near a heat source.
- Only use the chargers and power adapters provided. Do not use other chargers or power adapters as this may damage the device and battery packs.
- Do not touch the plug contacts with sharp or metal objects.
- The unit should be set up and used so that parts of the user's body other than the hands are maintained at a distance of approximately 8 inches (20 cm) or more.
- The wall mounting height is less than 2 m for the baby unit.

## **CAUTION**

There is a risk of explosion if the battery is replaced by an incorrect type. Dispose of used batteries according to the instructions.

# Welcome...

## to your new Smart Video Baby Monitor!

Thank you for purchasing your new Smart Nursery product. Now you can see and hear your baby sleeping in another room or you can monitor your older children in their playroom.

### Important

To use your baby and parent units together, you must be able to establish a radio link between them, and the range will be affected by environmental conditions.

Any large metal object, like a refrigerator, a mirror, a filing cabinet, a metallic door or reinforced concrete between the baby and parent units may block the radio signal.

The signal strength may also be reduced by other solid structures, like walls, or by radio or electrical equipment, such as TVs, computers, cordless or mobile phones, fluorescent lights or dimmer switches.

Other 2.4GHz products, such as wireless networks (Wi-Fi® routers), Bluetooth™ systems, microwave ovens or other baby monitors, may cause interference with this product, so keep the baby monitor at least 5 ft (1.5 m) away from these types of products, or switch them off if they appear to be causing interference.

If the signal is weak, try moving the parent and/or the baby unit(s) to different positions in rooms.

### Need help?

If you have any problems setting up or using your **PIP1700 HD TOUCH CONNECT, PIP1700-2 HD TOUCH CONNECT, PIP1700-3 HD TOUCH CONNECT or PIP1700-4 HD TOUCH CONNECT**, please visit us at: [motorolanursery.com/support](http://motorolanursery.com/support)

Alternatively, you may find the answer in the 'Help' section at the back of this guide.

**This User Guide provides you with all the information you need to get the most from your Smart Video Baby Monitor.**

**Read the instructions carefully, and be aware that this Smart Video Baby Monitor is only intended as an aid. It is not a substitute for responsible and proper adult supervision.**

**Before you use the Smart Video Baby Monitor, set up the parent and baby units. Follow the simple instructions in 'Getting started', on the next few pages.**

#### **Important**

Use only the supplied power adapter (DC5V / 1500 mA) for the camera unit and (DC5V / 2000mA) for the parent unit.

#### **Got everything?**

- Parent unit with built-in rechargeable Lithium-ion battery
- Baby (camera) unit
- AC power adapter for the parent unit
- AC power adapter for the baby (camera) unit
- Wall mount bracket and screws

**If you have purchased multi camera pack, you will also have the following additional items:**

- Baby (camera) unit(s)
- AC power adapter(s) for the baby (camera) unit(s)

For Wi-Fi® internet viewing you will need a suitable Android or iPhone/iPad device and Wi-Fi® internet connection of at least 0.6 Mbps upload bandwidth per baby (camera) unit.

## 1. Welcome

This booklet provides you the quick start information of your PIP1710 HD TOUCH CONNECT. For a full explanation of all features, download the user guide from [motorolanursery.com](http://motorolanursery.com).

## 2. Contents inside the box

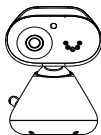

Baby unit

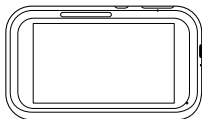

Parent unit



DC round socket adapter  
(for the baby/camera unit)



USB-C power socket  
(for the parent unit)

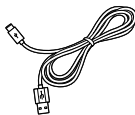

USB Type C cable



Wall mount bracket



Wall mounting screws and wall anchors



Quick Start Guide

### Need help?

If you have problems setting up or using your PIP1700 HD TOUCH CONNECT, please contact Customer Services at [motorolanursery.com/support](http://motorolanursery.com/support) or +1-800-763-2207 (United States and Canada).

### 3. At a glance

#### Baby (Camera) unit

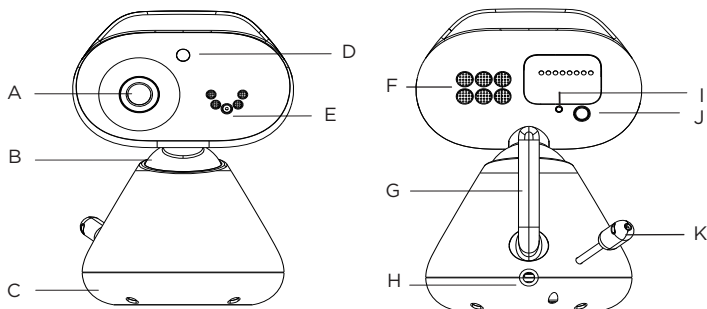

**A Camera**

**B Motorized pan tilt head**

It offers automated camera adjustments through swiping the touch screen of the parent unit.

**C Desk stand**

**D Light sensor and Infrared LEDs**

The light sensor detects a low level of ambient light to activate night vision mode. The infrared LEDs around the camera and behind the black lens are ON, and the screens on the parent unit and your smartphone turn black and white. The night vision icon will be displayed at the top of the screen.

**E Microphone**

It picks up the sound from the baby.

Note: Make sure you remove any cover or protective tape from it.

**F Speaker**

**G Antenna**

**H Power jack**

**I Power / Linking LED indicator**

It lights up in blue when the parent unit is powered on and linked to the baby (camera) unit.

It flashes red when the camera unit is not connected to either the parent unit or Wi-Fi routers.

It turns OFF automatically during night mode.

**J Pair button**

Press and hold to pair to the parent unit.

**K Temperature sensor**

## Parent unit

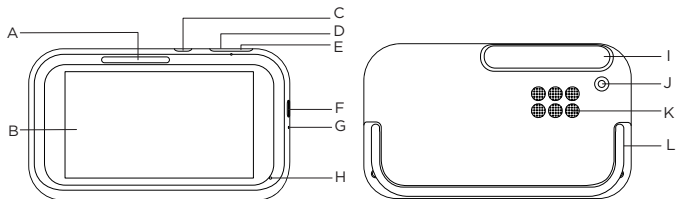

### A **Indications (green, green, orange, red, red)**

Power indication: it lights up in green when powered on; it lights up in red when charging and powered off.

Sound level indication: green, orange, red, red.

### B **Touch screen display**

### C **Power button**

Press to turn the display on or off. Press and hold to turn the parent unit on or off.

### D **Volume down**

Press to decrease the speaker volume.

### E **Volume up**

Press to increase the speaker volume.

### F **Power jack**

### G **Reset hole**

Use a small pin to insert into it to perform a system reset and recover the parent unit from a lock-up state.

### H **Microphone**

### I **Antenna**

### J **Flashlight**

### K **Speaker**

### L **Flip stand**



## 4. Connect and charge

### WARNING

- Strangulation Hazard. Children have STRANGLED in cords. Keep adapter cords out of the reach of children (more than 1 metre away). Never use extension cords with AC adapters. Only use the AC adapters provided.



**Note:** Use only the supplied power adapter (DC5V / 1500 mA) for the baby (camera) unit and (DC5V / 2000mA) for the parent unit.

### Baby (camera) unit

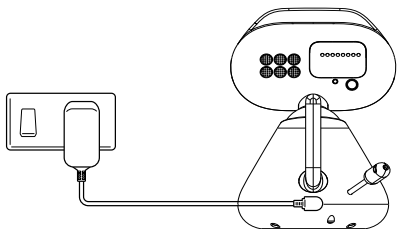

1. Plug the DC round socket adapter into the DC jack on the rear of the baby (camera) unit and plug the other end of the AC adapter into the AC power outlet.
2. Switch on the AC power (if your AC power outlet has a switch). The baby (camera) unit turns on and the power indicator lights up in blue and flashes in red after 30 seconds if the parent unit has not been powered up.

## Parent unit

A rechargeable battery is already pre-installed inside the parent unit. When fully charged, you can move the parent unit without losing the link and picture from the baby (camera) unit. When charging the battery for the first time, charge for at least 16 hours continuously. The subsequent charging time is about 8 to 10 hours a day. Fully charged batteries should give up to 8 hours usage time.

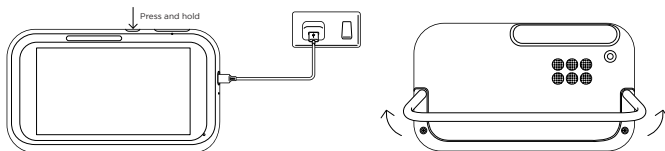











1. Plug the supplied USB type-C cable into the USB-C power socket.
2. Plug the USB-C power socket cable into the power jack on the side of the parent unit and plug the other end into the wall socket.
3. Switch on the AC power (if your AC power outlet has a switch).
4. The parent unit turns on automatically.
5. When the parent unit is fully charged,  will appear steadily on the screen display.
6. Flip out the stand on the back of the parent unit to set up the desktop stand.





**Note:** If the battery icon on the screen is red and an alert tone is heard, it means the battery level is low and needs recharging.

## Pair the baby (camera) unit to the parent unit

The video baby monitor is pre-registered to your parent unit. You do not need to register it again unless the baby (camera) unit loses its link with the parent unit. To re-register your baby (camera) unit, see the following steps.

1. Tap  on the menu bar.
2. Tap  and  /  /  /  will pop up.
3. Tap  /  /  /  to select a desired camera. The parent unit starts searching the baby (camera) unit.
4. Press and hold  on the rear of the baby (camera) unit until you hear '**Ready for pairing**'. When pairing is successful, the video from the baby (camera) unit will appear.

## Notes

A baby (camera) unit can be paired only to one parent unit each time. If a baby (camera) unit is currently paired with the parent unit,  /  /  /  will appear in black on the screen and cannot be selected. Select the grey one for a new registration.

## 5. Wall mount the baby (camera) unit

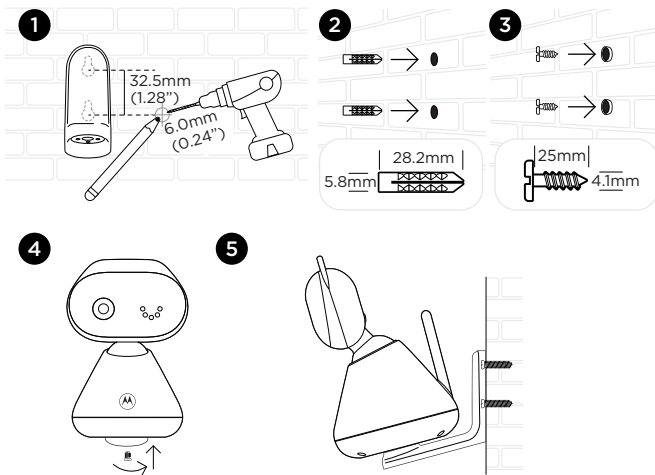

1. Place the supplied wall mount bracket on the wall and mark the positions of 2 screw holes. Drill a screw hole at each marking.
2. Install the supplied wall anchors into 2 screw holes on the wall.
3. Insert the supplied wall mounting screws into the wall anchors.
4. Fix and fasten this screw on the baby (camera) unit and the wall mount bracket.
5. Hang the wall mount bracket on the wall mounting screws on the wall.
6. Adjust the camera manually if necessary.

## 6. Before use

### 6.1 Intended use

Be aware that this Smart Digital Video Baby Monitor is only intended as an aid. It is not a substitute for responsible and proper adult supervision.

### 6.2 Setup location

- Do not place the baby (camera) unit or cords in the crib or within reach of the baby. The unit and cords should be more than 1 meter (3 feet) away from the baby.
- Make sure there is at least 2 meters (6 feet) between the parent and baby (camera) units to avoid audio feedback. If there is noise interference, move the baby (camera) and parent units further apart.
- Make sure the parent and baby (camera) units are not placed near other electrical equipment. Move the parent and baby (camera) units 1.5 meters (5 feet) away from other electrical equipment.
- If the baby (camera) unit loses its link with the parent unit, a lost link screen will be shown on the parent unit. Move the baby (camera) unit closer to the parent unit.



### 6.3 Operating range

The video baby monitor has a range of up to 300 metres (1000 feet) outdoors when there is a clear line of sight between the baby (camera) and parent units. Any obstruction between the units will reduce the range significantly.

### 6.4 Check the microphone and speaker

- Speak into the microphone of the baby (camera) unit. You should be able to hear the sound from the parent's unit.
- Adjust the speaker volume of the parent unit to the desired volume when necessary.



## 7. Use your video baby monitor

### 7.1 Use the touch screen

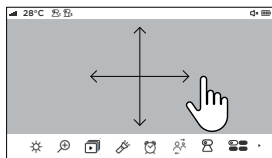

- Swipe up at the screen bottom to pop up the menu bar. Swipe down at the screen bottom to hide the menu bar.
- Scroll left or right on the menu bar to see all options.
- Swipe left or right to pan the camera view (not available in menu mode).
- Swipe up or down to tilt the camera view (not available in menu mode).

### 7.2 Parent unit main menu



- Adjust LCD brightness.
- Zoom in/out.
- Open the audio media playback.
- Turn on/off the flashlight.
- Set the alarm.
- Talk back.
- Camera selection.
- View multiple cameras.
- Screen on/off timer.
- Temperature unit °C or °F.

### 7.3 Status icons



- Indicates the current signal strength level (4 levels).
- Indicates the night vision mode is on. The video turns black and white.
- Indicates the screen off time is set.
- Unable to detect the baby unit.
- Indicates the current battery level (4 levels).
- The alarm is on.
- The speaker is muted.
- The flashlight is on.
- Zoom is set up.
- Audio media is playing.
- Cycle view from camera.
- Camera selected.
- °C °F Temperature unit.

**Note:** Depending on the video settings, the display will go blank after 5 minutes, 15 minutes, or 30 minutes of inactivity to save power.

## 7.4 Adjust the brightness on the parent unit

1. Tap  on the menu bar of the parent unit. The brightness status bar pops up.
2. Tap  /  or swipe the brightness status bar left or right to select the brightness level. There are 8 levels to choose from.

## 7.5 Zoom the screen



1. Tap  on the menu bar of the parent unit. The zoom status bar pops up.
2. Tap  /  or swipe the zoom status bar left or right to select 1x or 4x zoom.

## 7.6 Enable audio media playback



You can play back pre-recorded personal or preloaded audio content (lullabies, soothing sounds and English audio books) on the baby (camera) unit to soothe the baby. There are 10 preloaded lullabies/soothing sounds and 10 audio books in the baby (camera) unit.

### 7.6.1 Pre-recorded personal content playback



You can play back your personal content after recording the audio through the App.

1. Tap  on the menu bar of the parent unit. The options menu pops up.
2. Tap  to view the names of your recordings displaying on the screen.
3. Tap to select a desired recording and start/stop playback.





### 7.6.2 Lullabies/soothe sounds playback

1. Tap  on the menu bar of the parent unit. The options menu pops up.
2. Tap  to view the names of lullabies or soothe sounds displaying on the screen.
3. Tap to select a desired lullaby or soothe sound and start/stop playback.

### 7.6.3 English audio book playback

1. Tap  on the menu bar of the parent unit. The options menu pops up.
2. Tap  to view the names of audio books displaying on the screen.
3. Tap to select a desired audio book and start/stop playback.

### 7.6.4 Adjust the volume level of audio playback







1. Tap  on the menu bar of the parent unit. The options menu pops up.
2. Tap  on the option menu. The volume status bar pops up.
3. Tap  or  to select the volume level. There are 6 levels to choose from.

## 7.7 Turn the flashlight on or off

Tap  on the menu bar of the parent unit to turn on/off the flashlight.



## 7.8 Set the timer

You can set timers on the parent unit to remind you or caregivers of the time to feed the baby, change the baby's diaper or put the baby to bed.

1. Tap  on the menu bar of the parent unit.
2. Tap **on** to turn on the timer, then tap  or  to select the time. Each key press represents an interval of 15 minutes, up to an interval of 6 hours.
3. If the next feeding time is 4 hours later, press  or  to adjust the timer until 04:00 is displayed.
4. Tap **save** to confirm the time,  will appear on the status bar.
5. The parent unit will beep when the time limit is reached. Press any key to stop the timer.

## 7.9 Two-way talk

You can use the Talk Back feature to comfort and reassure your baby. Whilst using Talk Back you will not be able to hear your baby.











1. Tap  on the menu bar of the parent unit to talk to your baby through the parent unit's microphone.
2. Tap  again when you finish speaking.

## 7.10 Use the camera

### 7.10.1 Pair or add a camera with the parent unit

See 'Pair the baby (camera) unit to the parent unit' in Section 4.











### 7.10.2 Remove a camera

1. Tap  on the menu bar of the parent unit.
2. Tap  and  /  /  /  will pop up.
3. Tap  /  /  /  to select a desired camera to remove it from registration.

### Note



You cannot remove the camera if it is the only registered camera in the parent unit.

### 7.10.3 View a camera

1. Tap  on the menu bar of the parent unit.
2. Tap  and  /  /  /  will pop up.
3. Tap  /  /  /  to select a desired camera to view the picture from that camera. The selected camera will appear in black on the screen.

### 7.10.4 Use the patrol mode

This function is available if you have more than one baby (camera) unit.

1. Tap  on the menu bar of the parent unit.
2. Tap  and the screen will display images from different registered cameras every 12 seconds.

## 7.11 View multiple camera on screen

This function is available if you have more than one baby (camera) unit. When the split screen function is on, you can view multiple cameras on the screen and have a list of options.

- To turn on or off the split screen function, tap  on the menu bar of the parent unit.
- To select another screen, tap on the selected screen once.
- To hide or display the menu bar of that screen, tap on the selected screen twice.

## 7.12 Power saving mode

1. Tap  in the menu bar of the parent unit, the screen off timer: **off**, **5m**, **15m** or **30m** (m = minutes) will pop up.
2. Select a screen off time.
3. The screen will be off after the time limit is reached.
4. Tap once on the screen to wake it up. Tap twice to open the menu bar.

### Note

You can still hear the audio when the screen is off.

## 7.13 Set the temperature unit

The baby (camera) unit has a temperature sensor that can detect the baby room temperature.

1. Tap  on the menu bar of the parent unit. °C / °F will pop up on the screen.
2. Tap °C or °F to confirm the temperature format.

## 7.14 Default settings

|                             |        |
|-----------------------------|--------|
| Audio playback volume level | 3      |
| Brightness                  | 4      |
| Flashlight                  | Off    |
| Temperature unit            | °F     |
| Lullaby                     | 1      |
| Power saving                | 5 mins |
| Audio book                  | 1      |
| Parent unit speaker volume  | 4      |
| Alarm                       | Off    |
| Zoom                        | 1X     |



## 8. View the baby through your device

### Minimum system requirement

**Android™ System:** Version 7.0 or above

**iPhone® iOS:** Version 11.0 or above

**High Speed (Wi-Fi®) Internet:** At least 0.6 Mbps upload bandwidth per camera (you can test your internet speed on this site: <http://www.speedtest.net>).

### Connect to Wi-Fi® and use the Nursery App



Camera

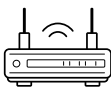

Connect to internet  
via Wi-Fi® router

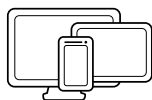

View your camera  
from my compatible  
device remotely

1. Scan the QR code with your smart device and download the **Motorola Nursery App** from App Store for iOS devices or from Google Play™ Store for Android™ devices.
2. Install the App on your device.
3. Follow the on-screen instructions to run and sign up or log in to the App.
4. Open the Motorola Nursery App on your compatible smartphone or tablet.
5. Follow the in-app instructions to create your account and connect to your device.



## 9. Help

### **No display**

- Try recharging the battery pack.
- Reset the parent and baby (camera) units. Unplug both units from the wall socket, then plug them back in.
- Check if the parent/baby (camera) unit is powered on.
- Press and hold the power button on the parent unit to switch it on.
- Make sure the correct camera is selected. Change the camera number if necessary.
- Make sure the display of the parent unit is turned on.
- The parent unit display will go blank after 5 minutes, 30 minutes or 60 minutes to save power (depending on video settings).

### **No sound or the audio level is low.**

- Make sure that the protective tapes on the parent and baby (camera) units are removed.
- Adjust the speaker volume level according to the instructions described in the user guide.

### **The baby (camera) unit has lost its link with the parent unit.**

- The baby (camera) unit is too far away and may be out of range. Move it closer to the parent unit.
- Disconnect both the parent and baby (camera) units from the power outlet. Wait for about 15 seconds and reconnect them. Allow up to one minute for the parent and baby (camera) units to synchronize.
- Re-register your baby (camera) unit if necessary, see page 13.

### **Noise interference on your parent unit**

- Make sure there is at least 3 to 6 feet between the parent and baby (camera) units to avoid audio feedback.
- The baby (camera) unit is too far away and may be out of range. Move it closer to the parent unit.
- Make sure the parent and baby (camera) units are not placed near other electrical equipment, such as a television, computer or cordless/mobile telephone. Move the parent and baby (camera) units 5 feet away from other electrical equipment.
- Use of other 2.4 GHz products, such as wireless networks (Wi-Fi® routers), Bluetooth™ systems, or microwave ovens, may cause interference with this product.
- If the signal is weak, try moving the parent and/or baby (camera) units to different positions in rooms.

**Noise interference on your device**

- To avoid background noise or echoes, ensure there is enough distance between your device and the camera (baby unit).
- Use of other 2.4 GHz products, such as wireless networks (Wi-Fi® routers), Bluetooth™ systems, or microwave ovens, may cause interference with this product. Keep the parent and baby (camera) units at least 5 feet away from these types of products, or switch them off if they appear to be causing interference.

**Lost connection**

- Check your Wi-Fi® settings and reconnect your Wi-Fi® if necessary. Ensure the baby (camera) unit is switched on. Wait for a few minutes for the baby (camera) unit to connect with the Wi-Fi® system.

**System Reset**

- When problems such as lost connection, no sound and no video cannot be fixed based on the above guides, you can try to do a system reset. Note that after system reset, you will need to do the pairing to the app again.  
system reset for the parent unit: on the left hand side of the parent unit and on the top of the DC socket, there is a small hole. Use a small pin to insert and press into it. The parent unit will go through system reset.  
system reset of the camera unit: follow the procedure as described in section 4.4 of this user guide.

For more support, you can reach us at: [motorolanursery.com/support](http://motorolanursery.com/support) or +1-800-763-2207 (United States and Canada).

## 10. Technical Specifications

|                                    |   |
|------------------------------------|---|
| RF frequency bands                 | 2400 MHz to 2483.5 MHz  |
| RF transmission power              | < 20dBm (only for CE)   |
| Power adapter for the camera units | Mass Power Electronic Ltd.<br>Model : S012-1B050150VU for USA/Canada<br>Model : S012-1B050150VE for Europe<br>Model : S012-1B050150VK for UK<br>Input 100-240V AC 50/60Hz, 300mA<br>Output DC5V 1.5A  |
| Power adapter for the parent units | Mass Power Electronic Ltd.<br>Model : NBS10B050200VUU for USA/Canada<br>Model : NBS10B050200VEU for Europe<br>Model : NBS10B050200VKU for UK<br>Input 100-240V AC 50/60Hz, 300mA Output DC5V 2.0A<br>OR<br>Baijunda Electronic Co. Ltd.<br>Model : UT-681A-5200ZCY for USA/Canada<br>Model : UT-681E-5200ZCY for Europe<br>Model : UT-681B-5200ZCY for UK<br>Input 100-240V AC 50/60Hz, 350mA<br>Output DC5V 2.0A |
| Parent unit battery information    | Amperex Technology Limited<br>3.8V, 2800mAh Lithium-Ion Polymer rechargeable battery pack   |

### **WARNING**

Use only with provided power adapters as tabulated in the above.

### **WARNING**

Do not attempt to replace the battery, but contact customer service if it needs replacing.

### **Note**

Specifications are subject to change without prior notice.

## **11. General information**

### **Consumer Products and Accessories Warranty**

Thank you for purchasing this Motorola branded product manufactured under license by Meizhou Guo Wei Electronics Co. LTD., AD1 section, The economy exploitation area, Meizhou, Guangdong, P.R.China (“MZGW”).

#### **What Does this Warranty Cover?**

Subject to the exclusions contained below, MZGW warrants that this Motorola branded product (“Product”) or certified accessory (“Accessory”) sold for use with this product that it manufactured to be free from defects in materials and workmanship under normal consumer usage for the period outlined below. This Limited Warranty is your exclusive warranty and is not transferable.

#### **Who is covered?**

This warranty extends only to the first consumer purchaser, and is not transferable.

#### **What will MZGW do?**

MZGW or its authorized distributor at its option and within a commercially reasonable time, will at no charge repair or replace any Products or Accessories that do not conform to this limited warranty. We may use functionally equivalent reconditioned / refurbished / pre-owned or new Products, Accessories or parts.

#### **What Other Limitations Are There?**

ANY IMPLIED WARRANTIES, INCLUDING WITHOUT LIMITATION THE IMPLIED WARRANTIES OF MERCHANTABILITY AND FITNESS FOR A PARTICULAR PURPOSE, SHALL BE LIMITED TO THE DURATION OF THIS LIMITED WARRANTY, OTHERWISE THE REPAIR OR REPLACEMENT PROVIDED UNDER THIS EXPRESS LIMITED WARRANTY IS THE EXCLUSIVE REMEDY OF THE CONSUMER, AND IS PROVIDED IN LIEU OF ALL OTHER WARRANTIES, EXPRESS OF IMPLIED. IN NO EVENT SHALL MOTOROLA OR MZGW BE LIABLE, WHETHER IN CONTRACT OR TORT (INCLUDING NEGLIGENCE) FOR DAMAGES IN EXCESS OF THE PURCHASE PRICE OF THE PRODUCT OR ACCESSORY, OR FOR ANY INDIRECT, INCIDENTAL, SPECIAL OR CONSEQUENTIAL DAMAGES OF ANY KIND, OR LOSS OF REVENUE OR PROFITS, LOSS OF BUSINESS, LOSS OF INFORMATION OR OTHER FINANCIAL LOSS ARISING OUT OF OR IN CONNECTION WITH THE ABILITY OR INABILITY TO USE THE PRODUCTS OR ACCESSORIES TO THE FULL EXTENT THESE DAMAGES MAY BE DISCLAIMED BY LAW.

Some jurisdictions do not allow the limitation or exclusion of incidental or consequential damages, or limitation on the length of an implied warranty, so the above limitations or exclusions may not apply to you. This warranty gives you specific legal rights, and you may also have other rights that vary from one jurisdiction to another.

| <b>Products Covered</b>  | <b>Length of Coverage</b>  |
|--|--|
| <b>Consumer Products</b>   | <b>Two (2) years</b> from the date of the products original purchase by the first consumer purchaser of the product.             |
| <b>Consumer Accessories (battery, power supply(s) and line cords)</b>  | <b>Ninety (90) days</b> from the date of the accessories original purchase by the first consumer purchaser of the product.       |
| <b>Consumer Products and Accessories that are Repaired or Replaced</b> | <b>The balance of the original warranty or for ninety (90) days</b> from the date returned to the consumer, whichever is longer. |

### **Exclusions**

**Normal Wear and Tear.** Periodic maintenance, repair and replacement of parts due to normal wear and tear are excluded from coverage.

**Batteries.** Only batteries whose fully charged capacity falls below 80% of their rated capacity and batteries that leak are covered by this limited warranty.

**Abuse & Misuse.** Defects or damage that result from: (a) improper operation, storage, misuse or abuse, accident or neglect, such as physical damage (cracks, scratches, etc.) to the surface of the product resulting from misuse; (b) contact with liquid, water, rain, extreme humidity or heavy perspiration, sand, dirt or the like, extreme heat, or food; (c) use of the Products or Accessories for commercial purposes or subjecting the Product or Accessory to abnormal usage or conditions; or (d) other acts which are not the fault of Motorola or MZGW are excluded from coverage.

**Use of Non-Motorola branded Products and Accessories.** Defects or damage that result from the use of Non-Motorola branded or certified Products or Accessories or other peripheral equipment are excluded from coverage.

**Unauthorized Service or Modification.** Defects or damages resulting from service, testing, adjustment, installation, maintenance, alteration, or modification in any way by someone other than Motorola, MZGW or its authorized service centers, are excluded from coverage.

**Altered Products.** Products or Accessories with (a) serial numbers or date tags that have been removed, altered or obliterated; (b) broken seals or that show evidence of tampering; (c) mismatched board serial numbers; or (d) nonconforming or non-Motorola branded housings, or parts, are excluded from coverage.

**Communication Services.** Defects, damages, or the failure of Products or Accessories due to any communication service or signal you may subscribe to or use with the Products or Accessories is excluded from coverage.

### **How to Obtain Warranty Service or Other Information?**

To obtain service or information, please visit us at: [motorolanursery.com/support](http://motorolanursery.com/support)

You will receive instructions on how to ship the Products or Accessories at your expense and risk, to a MZGW Authorized Repair Center.

To obtain service, you must include: (a) the Product or Accessory; (b) the original proof of purchase (receipt) which includes the date, place and seller of the Product; (c) if a warranty card was included in your box, a completed warranty card showing the serial number of the Product; (d) a written description of the problem; and, most importantly; (e) your address and telephone number.

### **FCC and IC regulations (FCC Part 15)**

This equipment has been tested and found to comply with the requirements for a Class B digital device, pursuant to Part 15 of the Federal Communications Commission (FCC) rules.

### **Industry Canada**

This device complies with Industry Canada licence-exempt RSS standard(s). Operation is subject to the following two conditions: (1) this device may not cause interference, and (2) this device must accept any interference, including interference that may cause undesired operation of the device.

### **Product disposal instructions**

#### **Product disposal instructions for residential users**

When you have no further use for it, please remove any batteries and dispose of them and the product according to your local authority's recycling processes. For more information, please contact your local authority or the retailer where the product was purchased.



#### **Product disposal instructions for business users**

Business users should contact their suppliers and check the terms and conditions of the purchase contract and ensure that this product is not mixed with other commercial waste for disposal.

## **EU Declaration of Conformity (DoC)**

Hereby, Meizhou Guo Wei Electronics Co. LTD declares that the product is in compliance with RE Directive 2014/53/EU. The full text of the EU declaration of conformity is available on the website: [motorolanursery.com](http://motorolanursery.com).

## **UK Declaration of Conformity (DoC)**

Hereby, MZGW declares that this product is in compliance with the requirements for UKCA marking. The UK Declaration of Conformity can be obtained at [motorolanursery.com](http://motorolanursery.com).

## **FCC and IC regulations**

### **FCC Caution:**

Any changes or modifications not expressly approved by the party responsible for compliance could void the user's authority to operate the equipment.

This device complies with part 15 of the FCC Rules. Operation is subject to the following two conditions: (1) This device may not cause harmful interference, and (2) this device must accept any interference received, including interference that may cause undesired operation.

### **IMPORTANT NOTE:**

This equipment has been tested and found to comply with the limits for a Class B digital device, pursuant to part 15 of the FCC Rules. These limits are designed to provide reasonable protection against harmful interference in a residential installation. This equipment generates, uses and can radiate radio frequency energy and, if not installed and used in accordance with the instructions, may cause harmful interference to radio communications. However, there is no guarantee that interference will not occur in a particular installation. If this equipment does cause harmful interference to radio or television reception, which can be determined by turning the equipment off and on, the user is encouraged to try to correct the interference by one or more of the following measures:

- Reorient or relocate the receiving antenna.
- Increase the separation between the equipment and receiver.
- Connect the equipment into an outlet on a circuit different from that to which the receiver is connected.
- Consult the dealer or an experienced radio/TV technician for help.



## **ISED Warning**

This device complies with Innovation, Science, and Economic Development Canada licence-exempt RSS standard(s). Operation is subject to the following two conditions:

- (1) this device may not cause interference, and
- (2) this device must accept any interference, including interference that may cause undesired operation of the device.

Le présent appareil est conforme aux CNR d'Innovation, Sciences et Développement économique Canada applicables aux appareils radio exempts de licence. L'exploitation est autorisée aux deux conditions suivantes :

- (1) l'appareil n' doit pas produire de brouillage, et
- (2) l'utilisateur de l'appareil doit accepter tout brouillage radioélectrique subi, même si le brouillage est susceptible d'en compromettre le fonctionnement.

## **Radiation Exposure Statement:**

The baby unit complies with FCC/ISED radiation exposure limits set forth for an uncontrolled environment. The baby unit should be installed and operated with minimum distance 20cm between the radiator & your body.

The parent unit has been tested and comply with FCC and ISED SAR limits. For face up operation, please hold the device 10mm from you face.

## **Déclaration d'exposition aux radiations:**

L'unité bébé est conforme aux limites d'exposition aux rayonnements FCC/ISED établies pour un environnement non contrôlé. L'unité bébé doit être installée et utilisée avec une distance minimale de 20 cm entre le radiateur et votre corps.

L'unité parent a été testée et est conforme aux limites SAR FCC et ISED. Pour un fonctionnement face vers le haut, tenez l'appareil à 10 mm de votre visage.

Manufactured, distributed or sold by  
Meizhou Guo Wei Electronics Co. LTD.,  
official licensee for this product.  
MOTOROLA and the Stylized M Logo are  
trademarks or registered trademarks of  
Motorola Trademark Holdings, LLC. and  
are used under license. All other  
trademarks are the property of their  
respective owners. © 2023 Motorola  
Mobility LLC. All rights reserved.



Version 1\_EN