



中认信通

CHINA CERTIFICATION ICT CO., LTD (DONGGUAN)



TEST REPORT

Applicant: Meizhou Guo Wei Electronics Co., Ltd.

Address: AD1 Section, Economic Development Area, Dongsheng Industrial District, Meizhou, Guangdong, China.

FCC ID: 2ARRB-PIP12PU

IC: 20353-PIP12PU

HVIN: PIP12PU

Product Name: Travel Audio Monitor

Standard(s): FCC PART 15D
RSS-213, ISSUE 3, MARCH 2015
RSS-GEN ISSUE 5, FEBRUARY 2021
AMENDMENT 2
ANSI C63.17-2013

The above equipment has been tested and found compliant with the requirement of the relative standards by China Certification ICT Co., Ltd (Dongguan)

Report Number: CR230309652-00B

Date Of Issue: 2023/5/8

Reviewed By: Sun Zhong

Sun Zhong

Title: Manager

Test Laboratory: China Certification ICT Co., Ltd (Dongguan)

No. 113, Pingkang Road, Dalang Town, Dongguan,

Guangdong, China

Tel: +86-769-82016888

Test Facility

The Test site used by China Certification ICT Co., Ltd (Dongguan) to collect test data is located on the No. 113, Pingkang Road, Dalang Town, Dongguan, Guangdong, China.

The lab has been recognized as the FCC accredited lab under the KDB 974614 D01 and is listed in the FCC Public Access Link (PAL) database, FCC Registration No. : 442868, the FCC Designation No. : CN1314.

The lab has been recognized by Innovation, Science and Economic Development Canada to test to Canadian radio equipment requirements, the CAB identifier: CN0123.

Declarations

China Certification ICT Co., Ltd (Dongguan) is not responsible for the authenticity of any test data provided by the applicant. Data included from the applicant that may affect test results are marked with a triangle symbol “▲”. Customer model name, addresses, names, trademarks etc. are not considered data.

Unless otherwise stated the results shown in this test report refer only to the sample(s) tested.

This report cannot be reproduced except in full, without prior written approval of the Company.

This report is valid only with a valid digital signature. The digital signature may be available only under the Adobe software above version 7.0.

This report may contain data that are not covered by the accreditation scope and shall be marked with an asterisk “★”.

CONTENTS

TEST FACILITY	2
DECLARATIONS.....	2
DOCUMENT REVISION HISTORY	5
1. GENERAL INFORMATION.....	6
1.1 PRODUCT DESCRIPTION FOR EQUIPMENT UNDER TEST (EUT)	6
1.2 DESCRIPTION OF TEST CONFIGURATION.....	7
1.2.2 Support Equipment List and Details	7
1.2.3 Support Cable List and Details	7
1.2.4 Block Diagram of Test Setup.....	8
1.3 MEASUREMENT UNCERTAINTY	9
2. SUMMARY OF TEST RESULTS	10
3. REQUIREMENTS AND TEST PROCEDURES	11
3.1 CONDUCTED EMISSIONS.....	11
3.1.1 Applicable Standard.....	11
3.1.2 EUT Setup.....	12
3.1.3 EMI Test Receiver Setup	12
3.1.4 Test Procedure	13
3.1.5 Corrected Amplitude & Margin Calculation.....	13
3.2 EMISSION BANDWIDTH:	14
3.2.1 Applicable Standard.....	14
3.2.2 EUT Setup.....	14
3.2.3 Test Procedure	14
3.3 PEAK TRANSMIT POWER:	15
3.3.1 Applicable Standard.....	15
3.3.2 EUT Setup.....	15
3.3.3 Test Procedure	15
3.4 POWER SPECTRAL DENSITY:	16
3.4.1 Applicable Standard.....	16
3.4.2 EUT Setup.....	16
3.4.3 Test Procedure	16
3.5 EMISSION INSIDE AND OUTSIDE THE SUB-BAND:	18
3.5.1 Applicable Standard.....	18
3.5.2 EUT Setup.....	18
3.5.3 Test Procedure	19
3.6 FREQUENCY STABILITY:	22
3.6.1 Applicable Standard.....	22
3.6.2 EUT Setup.....	22
3.6.3 Test Procedure	22
3.7 SPECIFIC REQUIREMENTS FOR UPCS DEVICE:	23
3.7.1 Applicable Standard.....	23
3.7.2 EUT Setup.....	27

3.7.3 Test Procedure27

3.8 ANTENNA REQUIREMENT.....29

3.8.1 Applicable Standard.....29

3.8.2 Judgment.....29

4. Test DATA AND RESULTS.....30

4.1 CONDUCTED EMISSIONS.....30

4.2 EMISSION BANDWIDTH:35

4.3 PEAK TRANSMIT POWER:38

4.4 POWER SPECTRAL DENSITY:40

4.5 EMISSION INSIDE AND OUTSIDE THE SUB-BAND:44

4.7 FREQUENCY STABILITY:62

4.8 SPECIFIC REQUIREMENTS FOR UPCS DEVICE:.....63

DOCUMENT REVISION HISTORY

Revision Number	Report Number	Description of Revision	Date of Revision
1.0	CR230309652-00B	Original Report	2023/5/8

1. GENERAL INFORMATION

1.1 Product Description for Equipment under Test (EUT)

EUT Name:	Travel Audio Monitor
EUT Model:	PIP12 TRAVEL PU
Operation Frequency:	1921.536-1928.448 MHz
Maximum Peak Output Power (Conducted):	18.2dBm
Modulation Type:	GFSK
Rated Input Voltage:	5Vdc from adapter or 2.4Vdc from battery
Serial Number:	22O3_2
EUT Received Date:	2023/3/8
EUT Received Status:	Good

Antenna Information Detail▲:

Antenna Type	input impedance (Ohm)	Frequency Range	Antenna Gain
PCB	50	1920-1930MHz	-1.01 dBi

The Method of §15.203 Compliance:

- Antenna must be permanently attached to the unit.
- Antenna must use a unique type of connector to attach to the EUT.
- Unit must be professionally installed, and installer shall be responsible for verifying that the correct antenna is employed with the unit.

Accessory Information:

Accessory Description	Manufacturer	Model
Adapter 1	Shenzhen Baijunda Electronic Co., Ltd	UT-681A-5100UY
Adapter 2	TEN PAO INTERNATIONAL LTD.	S005CAU0500100

1.2 Description of Test Configuration

1.2.1 EUT Operation Condition:

EUT Operation Mode:	The system was configured for testing in Engineering Mode, which was provided by the manufacturer.
Equipment Modifications:	No
EUT Exercise Software:	No
The engineering mode was provided by manufacturer. The maximum power was configured default, that was provided by the manufacturer ▲ :	

1.2.2 Support Equipment List and Details

Manufacturer	Description	Model	Serial Number
R&S	Digital Radio communication Tester	CMD 60M	846956/010
Unknown	Antenna	Unknown	Unknown

1.2.3 Support Cable List and Details

Cable Description	Shielding Type	Ferrite Core	Length (m)	From Port	To
USB Cable	No	No	2	EUT	Adapter

1.2.4 Block Diagram of Test Setup

AC line conducted emissions:

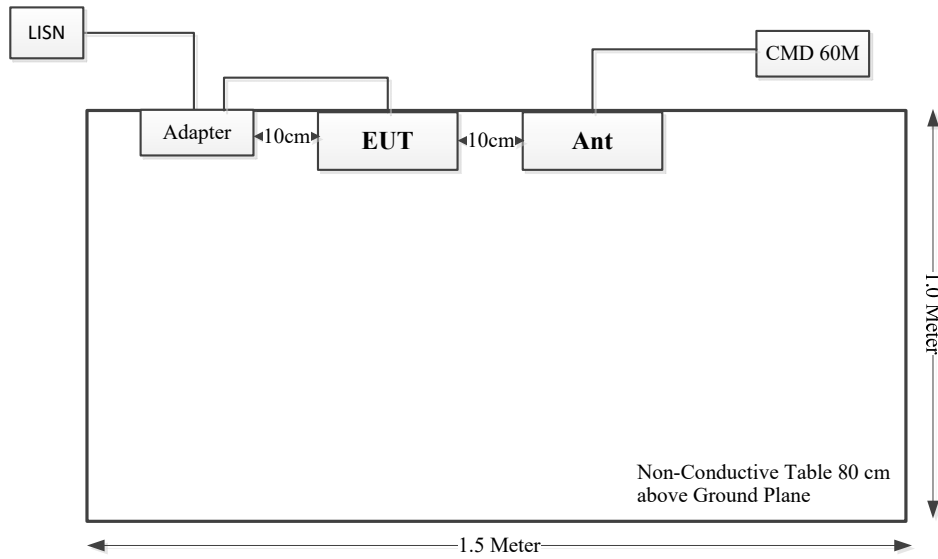

Radiated Spurious Emissions:

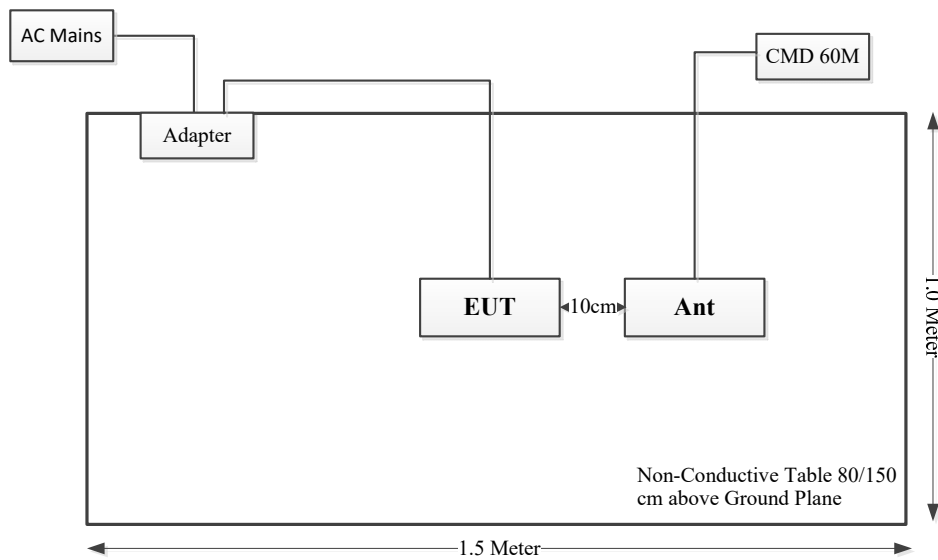

1.3 Measurement Uncertainty

Otherwise required by the applicant or Product Regulations, Decision Rule in this report did not consider the uncertainty. The extended uncertainty given in this report is obtained by combining the standard uncertainty times the coverage factor K with the 95% confidence interval.

Parameter	Measurement Uncertainty
Occupied Channel Bandwidth	±5 %
RF output power, conducted	±0.61dB
Power Spectral Density, conducted	±0.61 dB
Unwanted Emissions, radiated	30M~200MHz: 4.15 dB,200M~1GHz: 5.61 dB,1G~6GHz: 5.14 dB, 6G~18GHz: 5.93 dB,18G~26.5G:5.47 dB,26.5G~40G:5.63 dB
Unwanted Emissions, conducted	±1.26 dB
Temperature	±1 °C
Humidity	±5%
DC and low frequency voltages	±0.4%
AC Power Lines Conducted Emission	2.8 dB (150 kHz to 30 MHz)

2. SUMMARY OF TEST RESULTS

Standard(s) Section	Test Items	Result
FCC § 15.315, § 15.207 RSS-213 Clause 5.4	Conducted Emission	Compliant
FCC § 15.323 (a) RSS-213 Clause 5.5	Emission Bandwidth	Compliant
FCC § 15.319 (c) RSS-213 Clause 5.6	Peak Transmit Power	Compliant
FCC § 15.319 (d) RSS-213 Clause 5.7	Power Spectral Density	Compliant
FCC § 15.323 (d) RSS-213 Clause 5.8	Emission Inside and Outside the sub-band	Compliant
FCC § 15.323 (f) RSS-213 Clause 5.3	Frequency Stability	Compliant
FCC § 15.323 (c)(e) & § 15.319 (f) RSS-213 Clause 5.1 & 5.2	Specific Requirements for UPCS	Compliant
FCC § 15.317, § 15.203 RSS-Gen Clause 6.8	Antenna Requirement	Compliant

3. REQUIREMENTS AND TEST PROCEDURES

3.1 Conducted Emissions

3.1.1 Applicable Standard

FCC§15.315

An unlicensed PCS device that is designed to be connected to the public utility (AC) power line must meet the limits specified in §15.207.

RSS-213 Clause 5.4

The limits of AC power line conducted emissions are given in RSS-Gen.

RSS-Gen Clause 8.8

Unless stated otherwise in the applicable RSS, for radio apparatus that are designed to be connected to the public utility AC power network, the radio frequency voltage that is conducted back onto the AC power line on any frequency or frequencies within the range 150 kHz to 30 MHz shall not exceed the limits in table 4, as measured using a 50 μ H / 50 Ω line impedance stabilization network. This requirement applies for the radio frequency voltage measured between each power line and the ground terminal of each AC power-line mains cable of the EUT.

For an EUT that connects to the AC power lines indirectly, through another device, the requirement for compliance with the limits in table 4 shall apply at the terminals of the AC power-line mains cable of a representative support device, while it provides power to the EUT. The lower limit applies at the boundary between the frequency ranges. The device used to power the EUT shall be representative of typical applications.

Table 4 – AC power-line conducted emissions limits

Frequency (MHz)	Conducted limit (dB μ V)	
	Quasi-peak	Average
0.15 - 0.5	66 to 56 ¹	56 to 46 ¹
0.5 – 5	56	46
5 – 30	60	50

Note 1: The level decreases linearly with the logarithm of the frequency.

For an EUT with a permanent or detachable antenna operating between 150 kHz and 30 MHz, the AC power-line conducted emissions must be measured using the following configurations:

- (a) Perform the AC power-line conducted emissions test with the antenna connected to determine compliance with the limits of table 4 outside the transmitter's fundamental emission band.
- (b) Retest with a dummy load instead of the antenna to determine compliance with the limits of table 4 within the transmitter's fundamental emission band. For a detachable antenna, remove the antenna and connect a suitable dummy load to the antenna connector. For a permanent antenna, remove the antenna and terminate the RF output with a dummy load or network that simulates the antenna in the fundamental frequency band.

3.1.2 EUT Setup

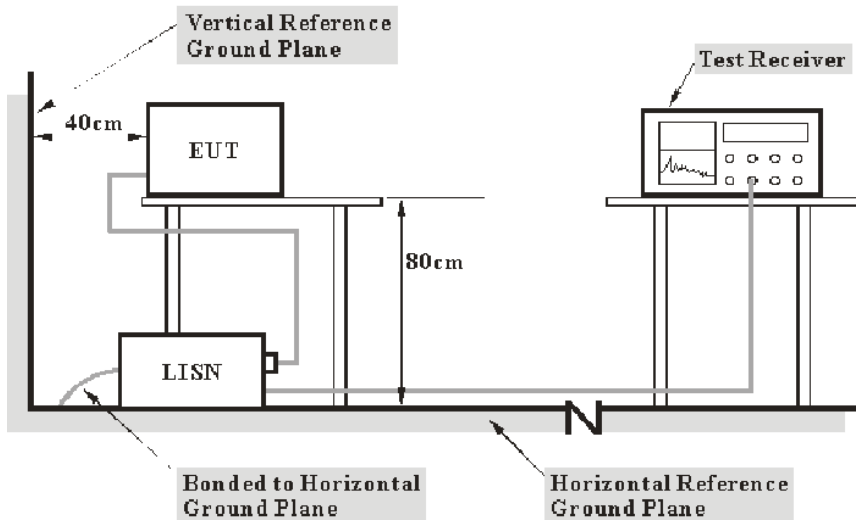

- Note: 1. Support units were connected to second LISN.
 2. Both of LISNs (AMN) 80 cm from EUT and at the least 80 cm from other units and other metal planes support units.

The setup of EUT is according with per ANSI C63.10-2013 measurement procedure. The specification used was with the FCC 15.315, FCC 15.207 and RSS-Gen limits.

The spacing between the peripherals was 10 cm.

The adapter or EUT was connected to the main LISN with a 120 V/60 Hz AC power source.

3.1.3 EMI Test Receiver Setup

The EMI test receiver was set to investigate the spectrum from 150 kHz to 30 MHz.

During the conducted emission test, the EMI test receiver was set with the following configurations:

Frequency Range	IF B/W
150 kHz – 30 MHz	9 kHz

3.1.4 Test Procedure

The frequency and amplitude of the six highest ac power-line conducted emissions relative to the limit, measured over all the current-carrying conductors of the EUT power cords, and the operating frequency or frequency to which the EUT is tuned (if appropriate), should be reported, unless such emissions are more than 20 dB below the limit. AC power-line conducted emissions measurements are to be separately carried out only on each of the phase (“hot”) line(s) and (if used) on the neutral line(s), but not on the ground [protective earth] line(s). If less than six emission frequencies are within 20 dB of the limit, then the noise level of the measuring instrument at representative frequencies should be reported. The specific conductor of the power-line cord for each of the reported emissions should be identified. Measure the six highest emissions with respect to the limit on each current-carrying conductor of each power cord associated with the EUT (but not the power cords of associated or peripheral equipment that are part of the test configuration). Then, report the six highest emissions with respect to the limit from among all the measurements identifying the frequency and specific current-carrying conductor identified with the emission. The six highest emissions should be reported for each of the current-carrying conductors, or the six highest emissions may be reported over all the current-carrying conductors.

3.1.5 Corrected Amplitude & Margin Calculation

The basic equation is as follows:

Result = Reading + Factor

Factor = attenuation caused by cable loss + voltage division factor of AMN

The “**Margin**” column of the following data tables indicates the degree of compliance within the applicable limit. The equation for margin calculation is as follows:

Margin = Limit – Result

3.2 Emission Bandwidth:

3.2.1 Applicable Standard

FCC §15.323 (a)

Operation shall be contained within the 1920–1930 MHz band. The emission bandwidth shall be less than 2.5 MHz and greater than 50 kHz.

RSS-213 Clause 5.5

The emission bandwidth shall not be less than 50 kHz nor more than 2.5 MHz.

3.2.2 EUT Setup

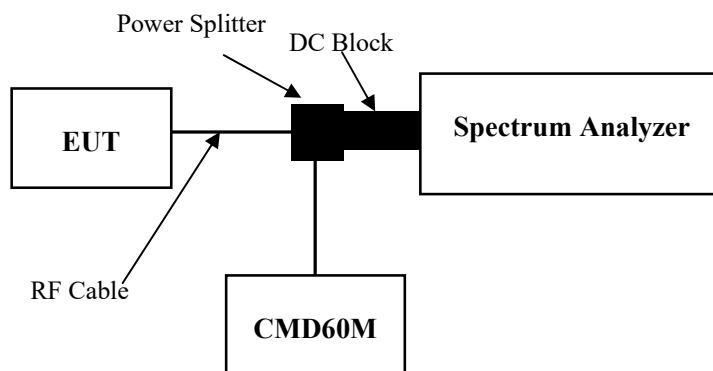

3.2.3 Test Procedure

According to ANSI C63.17-2013 Section 6.1.3

Table 3—Spectrum analyzer settings for measurement of emissions bandwidth *B*

RBW	Approximately 1% of the emission bandwidth (a rough estimate may be obtained from peak power level measurement, or use manufacturer's declared value)
Video bandwidth	$\geq 3 \times$ the RBW
Center frequency	Nominal center frequency of channel
Span	$\geq 2 \times$ the expected emission bandwidth
Sweep time	Coupled to frequency span and RBW
Amplitude scale	Log
Detection	Peak detection with maximum hold enabled

Record the maximum level of the modulated carrier. Find the two furthest frequencies above and below the frequency of the maximum level of the modulated carrier where the signal level is 26 dB below the peak level of the carrier. The difference in frequency between these two frequencies is the emission bandwidth.

If after measuring the emission bandwidth, it is found that the RBW used was not approximately 1% of the emission bandwidth, then adjust the RBW and repeat the procedure until the correct RBW is used. If the spectrum analyzer has fixed values of RBW, the one that is the nearest to 1% of the emission bandwidth is acceptable, provided it is no less than 0.5% of the emission bandwidth and no greater than 2% of the emission bandwidth.

3.3 Peak Transmit Power:

3.3.1 Applicable Standard

FCC §15.319 (c)

Peak transmit power shall not exceed 100 microwatts multiplied by the square root of the emission bandwidth in hertz. Peak transmit power must be measured over any interval of continuous transmission using instrumentation calibrated in terms of an rms-equivalent voltage. The measurement results shall be properly adjusted for any instrument limitations, such as detector response times, limited resolution bandwidth capability when compared to the emission bandwidth, sensitivity, etc., so as to obtain a true peak measurement for the emission in question over the full bandwidth of the channel.

RSS-213 Clause 5.6

Peak transmit power shall not exceed $100 \mu\text{W}$ multiplied by the square root of the occupied bandwidth in hertz. The peak transmit power shall be reduced by the amount in decibels that the maximum directional gain of the antenna exceeds 3 dBi.

3.3.2 EUT Setup

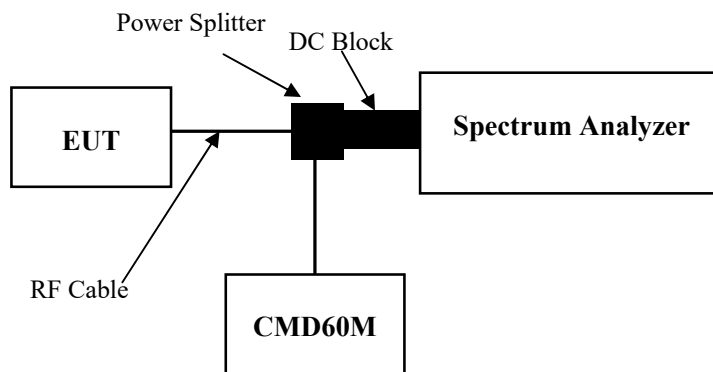

3.3.3 Test Procedure

According to ANSI C63.17-2013 Section 6.1.2

The resolution bandwidth (RBW) setting for this test must be adjusted by repeating this test and using increasing values of the RBW until there are negligible changes (within ± 0.5 dB) in the measured values of the maximum power.

Table 2—Spectrum analyzer settings for determining the peak power

RBW	\geq Emission bandwidth
Video bandwidth	\geq RBW
Span	Zero
Center frequency	Nominal center frequency of transmit carrier
Amplitude scale	Log (linear may be used if analyzer has sufficient linear dynamic range and accuracy)
Detection	Peak detection
Trigger	Video
Sweep rate	Sufficiently rapid to permit the transmit pulse to be resolved accurately

3.4 Power Spectral Density:

3.4.1 Applicable Standard

FCC §15.319 (d)

Power spectral density shall not exceed 3 milliwatts in any 3 kHz bandwidth as measured with a spectrum analyzer having a resolution bandwidth of 3 kHz.

RSS-213 Clause 5.7

The peak-hold power spectral density of transmitters shall not exceed 12 mW per any 3 kHz bandwidth. As an alternative to the peak-hold power spectral density, the time-averaged power spectral density may be measured and it shall not exceed 3 mW per any 3 kHz bandwidth.

3.4.2 EUT Setup

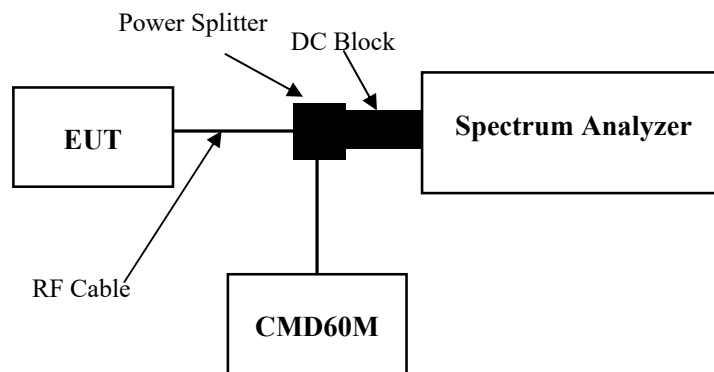

3.4.3 Test Procedure

According to ANSI C63.17-2013 Section 6.1.5

The EUT transmit data sequence and mode of operation shall be representative of that encountered in normal operation, so that transient effects associated with transmission bursts or data content are captured by the PSD measurement.

Table 4—Spectrum analyzer settings for finding of the maximum of PSD_{EUT}

RBW	3 kHz
Video bandwidth	$\geq 3 \times \text{RBW}$
Span	Zero span at frequency with the maximum level (frequency determined in 6.1.3 if the same type of signal (continuous versus burst) was used in 6.1.3)
Center frequency	Spectral peak as determined in 6.1.3
Sweep time	For burst signals, sufficient to include essentially all of the maximum length burst at the output of a 3 kHz filter (e.g., maximum input burst duration plus 600 μs). For continuous signals, 20 ms.
Amplitude scale	Log power
Detection	Sample detection and averaged for a minimum of 100 sweeps
Trigger	External or internal

For burst-type signals, arrange to measure the wideband burst duration of each burst analyzed and compute the mean duration.

Determine the level that is 20 dB below the first peak. Record the power-averaged waveform between the 20 dB threshold levels around the first peak with at least 30 000 samples per second as shown in Figure 4. Multiple wideband bursts may produce the waveform between -20 dB peaks; these must be included in the determination of the average burst length. If there is no level that is 20 dB below the peak, then analyze the complete sweep and include all of the wideband waveform that occurs during the sweep time in the computation of average burst length.

Sum the values of the sample points (in linear units of power) and divide by the sample frequency to obtain the total pulse energy in the 3 kHz bandwidth, then divide by the average duration of the wideband input pulse to obtain the average pulse power.

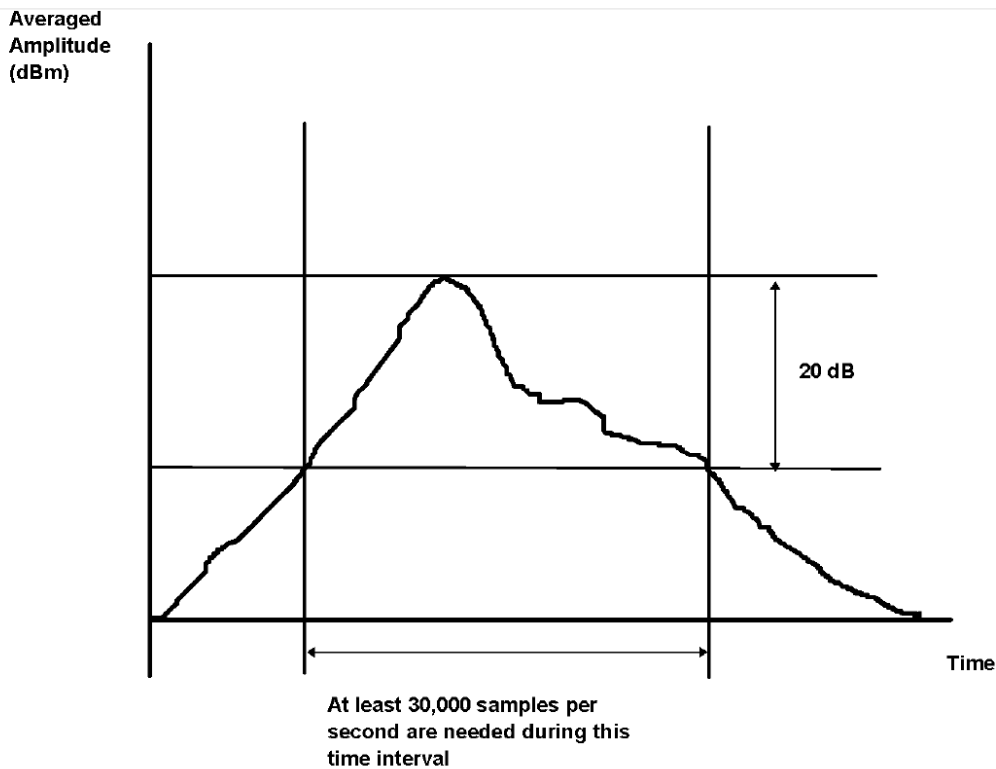

Figure 4—Computed average transient method: Sampling of the averaged power waveform measured with 3 kHz RBW

3.5 Emission Inside and Outside the Sub-band:

3.5.1 Applicable Standard

FCC §15.323 (d)

Emissions outside the band shall be attenuated below a reference power of 112 milliwatts as follows: 30 dB between the band and 1.25 MHz above or below the band; 50 dB between 1.25 and 2.5 MHz above or below the band; and 60 dB at 2.5 MHz or greater above or below the band. Emissions inside the band must comply with the following emission mask: In the bands between 1B and 2B measured from the center of the emission bandwidth the total power emitted by the device shall be at least 30 dB below the transmit power permitted for that device; in the bands between 2B and 3B measured from the center of the emission bandwidth the total power emitted by an intentional radiator shall be at least 50 dB below the transmit power permitted for that radiator; in the bands between 3B and the band edge the total power emitted by an intentional radiator in the measurement bandwidth shall be at least 60 dB below the transmit power permitted for that radiator. B” is defined as the emission bandwidth of the device in hertz. Compliance with the emission limits is based on the use of measurement instrumentation employing peak detector function with an instrument resolution bandwidth approximately equal to 1.0 percent of the emission bandwidth of the device under measurement.

RSS-213 Clause 5.8

Emissions outside the 1920-1930 MHz Band

Emissions outside the 1920-1930 MHz band shall be attenuated below a reference power of 112 milliwatts (-9.5 dBW) by at least:

- 30 dB between the band edges and 1.25 MHz above and below the band edges;
- 50 dB between 1.25 MHz and 2.5 MHz above or below the band edges; and
- 60 dB at 2.5 MHz or greater above or below the band edges.

Emissions inside the 1920-1930 MHz Band

Emissions inside the 1920-1930 MHz band shall be attenuated below the transmit power permitted for that device, as follows:

- 30 dB between the frequencies 1B and 2B measured from the centre of the occupied bandwidth;
- 50 dB between the frequencies 2B and 3B measured from the centre of the occupied bandwidth; and
- 60 dB between the frequencies 3B and band edge;

Where B is the occupied bandwidth in hertz.

3.5.2 EUT Setup

Radiated Emission Below 1GHz:

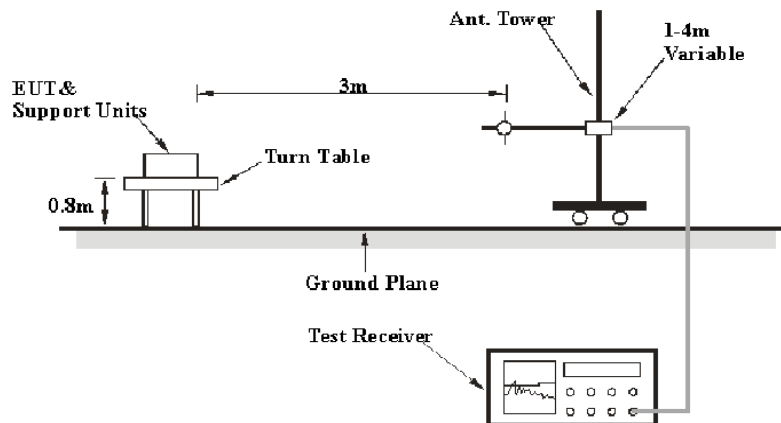

Radiated Emission Above 1GHz:

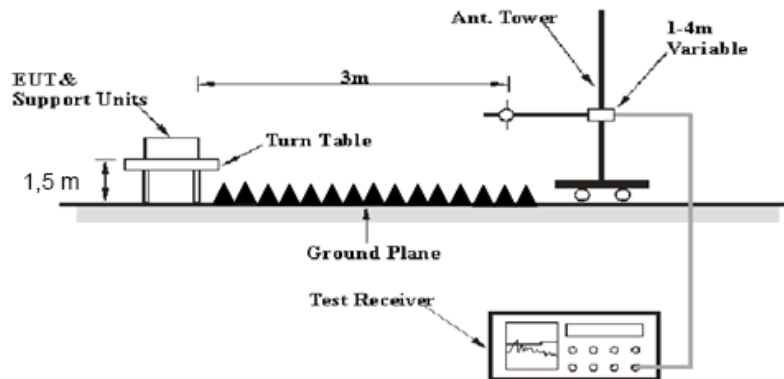

The radiated emission tests were performed in the 3 meters test site.

RF Conducted Emission:

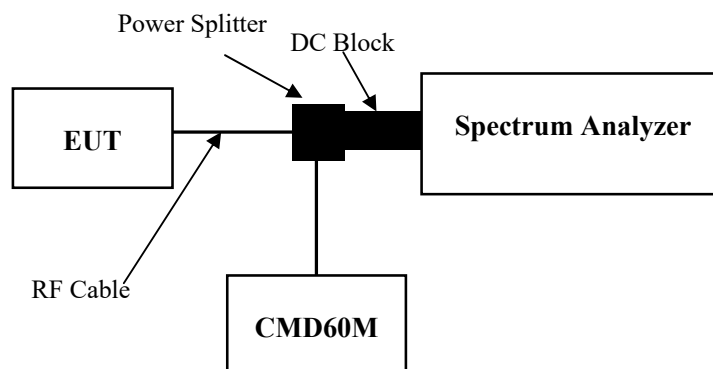

3.5.3 Test Procedure

According to ANSI C63.17-2013 Section 6.1.6

In-band emission:

In the region between 1B and 2B from the center of the RF carrier, the measured emission level (measured with 1% of emission bandwidth) shall not exceed 30 dB below the permitted peak power for the EUT.

In the region between 2B and 3B from the center of the RF carrier, the measured emission level shall not exceed 50 dB below the permitted peak power for the EUT.

Table 5—Spectrum analyzer settings for measuring in-band emissions

RBW	Approximately 1% of the emission bandwidth (<i>B</i>)
Video bandwidth	$3 \times \text{RBW}$
Sweep time	The sweep time shall be sufficiently slow that the swept frequency rate shall not exceed one RBW per three transmit bursts.
Number of sweeps	Sufficient to stabilize the trace
Amplitude scale	Log
Detection	Peak detection and max hold enabled
Span	Approximately equal to $3.5 B$

In the region between $3B$ and the UPCS band edge, as measured from the center of the RF carrier, the measured emission level shall not exceed 60 dB below the permitted peak power for the EUT.

Out-band emission:

Out-of-band tests shall be performed with the RF carrier set to the lowest and highest carriers defined by the EUT. The spectrum analyzer settings for in-band unwanted emissions in 6.1.6.1 also apply to out-of-band emissions. The EUT shall pass the tests of item a), item b), and either item c) or item d), as follows:

- a) In the region between the band edges and 1.25 MHz below and above the lower and the upper band edges, respectively, the measured emission level shall not exceed -9.5 dBm.
- b) In the region between 1.25 and 2.5 MHz below and above the lower and the upper band edges, respectively, the measured emission level shall not exceed -29.5 dBm.
- c) In the region at 2.5 MHz or greater below and above the lower and upper band edges, respectively, the measured emission level shall not exceed -39.5 dBm.
- d) In the region at 2.5 MHz or greater below and above the lower and upper band edges, respectively, the measured emission level shall not exceed the limits of 47CFR15.209. Measurement shall be made as a radiated test.

UPCS devices, in general, include digital circuitry not directly associated with the radio transmitter and are subject to the requirements for unintentional radiators as described in 47CFR15.109, for both in-band and out-of-band emissions. These emissions shall be measured with the EUT operating in receive and transmit modes. For the transmit mode, do not measure within 3.75 MHz or $3B$, whichever is the largest, of the edges of the band. Emissions that are directly caused by digital circuits in the transmit path do not have to meet 47CFR15.109 limits, but shall meet those limits as mentioned in the preceding list.

For Radiated Emission:

Maximizing procedure was performed on the highest emissions to ensure that the EUT complied with all installation combinations.

Data was recorded in Quasi-peak detection mode for frequency range of 30 MHz-1 GHz, peak and Average detection modes for frequencies above 1 GHz.

Corrected Amplitude & Margin Calculation

The basic equation is as follows:

Result = Reading + Factor

Factor = Antenna Factor + Cable Loss- Amplifier Gain

The “**Margin**” column of the following data tables indicates the degree of compliance within the applicable limit. The equation for margin calculation is as follows:

Margin = Limit – Result

3.6 Frequency Stability:

3.6.1 Applicable Standard

FCC §15.323(f)

The frequency stability of the carrier frequency of the intentional radiator shall be maintained within ± 10 ppm over 1 hour or the interval between channel access monitoring, whichever is shorter. The frequency stability shall be maintained over a temperature variation of -20° to $+ 50^{\circ}$ C at normal supply voltage, and over a variation in the primary supply voltage of 85 percent to 115 percent of the rated supply voltage at a temperature of 20° C. For equipment that is capable only of operating from a battery, the frequency stability tests shall be performed using a new battery without any further requirement to vary supply voltage.

RSS-213 Clause 5.3

The carrier frequency stability shall be maintained within ± 10 ppm ($\pm 0.001\%$).

3.6.2 EUT Setup

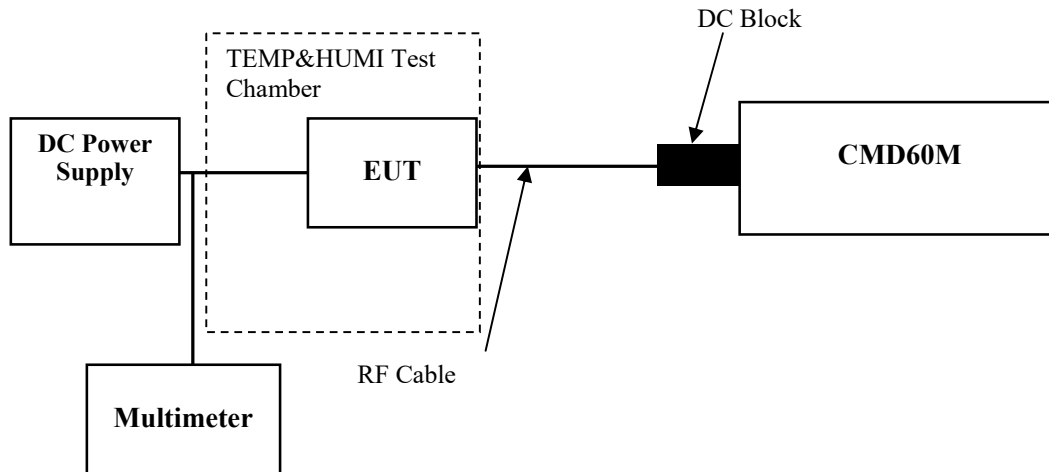

3.6.3 Test Procedure

According to ANSI C63.17-2013 Section 6.2.1.2

This test does not apply to an EUT that is capable only of operating from a battery. For a mains-powered EUT, the mean value of the carrier frequency shall be measured at the power supply voltage extremes of row 1 of Table 7.

Table 7—Test parameters for carrier-frequency stability testing

Temperature	Supply voltage
$20^{\circ}\text{C} \pm 2^{\circ}\text{C}$	85% to 115% of declared nominal voltage
$-20^{\circ}\text{C} \pm 2^{\circ}\text{C}$	All declared nominal(s)
$+50^{\circ}\text{C} \pm 2^{\circ}\text{C}$	All declared nominal(s)

During test, the equipment shall be placed in the boxes and set the temperature to the specified requirement until the thermal balance has been reached.

3.7 Specific Requirements For UPCS Device:

3.7.1 Applicable Standard

FCC §15.319(f)

The device shall automatically discontinue transmission in case of either absence of information to transmit or operational failure. The provisions in this section are not intended to preclude transmission of control and signaling information or use of repetitive codes used by certain digital technologies to complete frame or burst intervals.

FCC §15.323(c)

Devices must incorporate a mechanism for monitoring the time and spectrum windows that its transmission is intended to occupy. The following criteria must be met:

- (1) Immediately prior to initiating transmission, devices must monitor the combined time and spectrum windows in which they intend to transmit for a period of at least 10 milliseconds for systems designed to use a 10 milliseconds or shorter frame period or at least 20 milliseconds for systems designed to use a 20 milliseconds frame period.
- (2) The monitoring threshold must not be more than 30 dB above the thermal noise power for a bandwidth equivalent to the emission bandwidth used by the device.
- (3) If no signal above the threshold level is detected, transmission may commence and continue with the same emission bandwidth in the monitored time and spectrum windows without further monitoring. However, occupation of the same combined time and spectrum windows by a device or group of cooperating devices continuously over a period of time longer than 8 hours is not permitted without repeating the access criteria.
- (4) Once access to specific combined time and spectrum windows is obtained an acknowledgment from a system participant must be received by the initiating transmitter within one second or transmission must cease. Periodic acknowledgments must be received at least every 30 seconds or transmission must cease. Channels used exclusively for control and signaling information may transmit continuously for 30 seconds without receiving an acknowledgment, at which time the access criteria must be repeated.
- (5) If access to spectrum is not available as determined by the above, and a minimum of 20 duplex system access channels are defined for the system, the time and spectrum windows with the lowest power level may be accessed. A device utilizing the provisions of this paragraph must have monitored all access channels defined for its system within the last 10 seconds and must verify, within the 20 milliseconds (40 milliseconds for devices designed to use a 20 milliseconds frame period) immediately preceding actual channel access that the detected power of the selected time and spectrum windows is no higher than the previously detected value. The power measurement resolution for this comparison must be accurate to within 6 dB. No device or group of co-operating devices located within 1 meter of each other shall during any frame period occupy more than 6 MHz of aggregate bandwidth, or alternatively, more than one third of the time and spectrum windows defined by the system.
- (6) If the selected combined time and spectrum windows are unavailable, the device may either monitor and select different windows or seek to use the same windows after waiting an amount of time, randomly chosen from a uniform random distribution between 10 and 150 milliseconds, commencing when the channel becomes available.
- (7) The monitoring system bandwidth must be equal to or greater than the emission bandwidth of the intended transmission and have a maximum reaction time less than $50 \times \text{SQRT}(1.25/\text{emission bandwidth in MHz})$ microseconds for signals at the applicable threshold level but shall not be required to be less than 50 microseconds. If a signal is detected that is 6 dB or more above the applicable threshold level, the maximum reaction time shall be $35 \times \text{SQRT}(1.25/\text{emission bandwidth in MHz})$ microseconds but shall not be required to be less than 35 microseconds.

(8) The monitoring system shall use the same antenna used for transmission, or an antenna that yields equivalent reception at that location.

(9) Devices that have a power output lower than the maximum permitted under this subpart may increase their monitoring detection threshold by one decibel for each one decibel that the transmitter power is below the maximum permitted.

(10) An initiating device may attempt to establish a duplex connection by monitoring both its intended transmit and receive time and spectrum windows. If both the intended transmit and receive time and spectrum windows meet the access criteria, then the initiating device can initiate a transmission in the intended transmit time and spectrum window. If the power detected by the responding device can be decoded as a duplex connection signal from the initiating device, then the responding device may immediately begin transmitting on the receive time and spectrum window monitored by the initiating device.

(11) An initiating device that is prevented from monitoring during its intended transmit window due to monitoring system blocking from the transmissions of a co-located (within one meter) transmitter of the same system, may monitor the portions of the time and spectrum windows in which they intend to receive over a period of at least 10 milliseconds. The monitored time and spectrum window must total at least 50 percent of the 10 millisecond frame interval and the monitored spectrum must be within 1.25 MHz of the center frequency of channel(s) already occupied by that device or co-located co-operating devices. If the access criteria is met for the intended receive time and spectrum window under the above conditions, then transmission in the intended transmit window by the initiating device may commence.

(12) The provisions of (c)(10) or (c)(11) of this section shall not be used to extend the range of spectrum occupied over space or time for the purpose of denying fair access to spectrum to other devices. ANSI C63.17 2013 §6.2 Frequency and time stability and §7. Monitoring tests and §8. Time and spectrum window access procedure.

According to RSS-213 §5.1&§5.2 type of modulation and access protocol
Equipment certified under this standard shall use digital modulation.

In order to provide equitable access to the radio frequency spectrum, the licence-exempt PCS device must possess an access protocol.

FCC §15.323(e)

The frame period (a set of consecutive time slots in which the position of each time slot can be identified by reference to a synchronizing source) of an intentional radiator operating in this band shall be 20 milliseconds or 10 milliseconds/X where X is a positive whole number. Each device that implements time division for the purposes of maintaining a duplex connection on a given frequency carrier shall maintain a frame repetition rate with a frequency stability of at least 50 parts per million (ppm). Each device which further divides access in time in order to support multiple communication links on a given frequency carrier shall maintain a frame repetition rate with a frequency stability of at least 10 ppm. The jitter (time-related, abrupt, spurious variations in the duration of the frame interval) introduced at the two ends of such a communication link shall not exceed 25 microseconds for any two consecutive transmissions. Transmissions shall be continuous in every time and spectrum window during the frame period defined for the device.

RSS-213 Clause 5.1

Equipment certified under this standard shall use digital modulation. Both asynchronous and isochronous operations are permitted within the band 1920-1930 MHz.

RSS-213 Clause 5.2

In order to provide equitable access to the radio frequency spectrum, the LE-PCS device must possess an access protocol as described below.

LE-PCS devices shall automatically discontinue transmission in case of absence of information to transmit or operational failure. This is not intended to preclude the transmission of control and signaling information or the use of repetitive codes employed by certain digital technologies to complete frame or burst intervals.

Devices must incorporate a mechanism for monitoring the time and spectrum windows that their transmission is intended to occupy. The following criteria must be met:

(1) Immediately prior to initiating a transmission, devices must monitor the combined time and spectrum window that they intend to use to verify if the channel is free for at least 10 ms for systems designed to use a 10 ms or shorter frame period, or at least 20 ms for systems designed to use a 20 ms frame period.

(2) The monitoring threshold must not be more than 30 dB above the thermal noise power (KTB) of a bandwidth equivalent to the occupied bandwidth of the device.

(3) If no signal above the threshold level is detected, transmission may commence and continue with the same bandwidth in the monitored time and spectrum windows without further monitoring. Occupation of the same combined time and spectrum windows by a device or group of cooperating devices continuously over a period of time longer than 8 h is not permitted without repeating the access criteria.

(4) Once access to specific combined time and spectrum windows is obtained, an acknowledgement from a system participant must be received by the initiating transmitter within 1 s or transmission must cease.

Periodic acknowledgements must be received at least every 30 s or transmission must cease.

Channels used exclusively for control and signalling information may transmit continuously for 30 s without receiving an acknowledgement, at which time the access criteria must be repeated.

(5) If access to spectrum is not available as determined by the above, and a minimum of 20 duplex system access channels are defined for the system, the time and spectrum windows with the lowest power level may be accessed.

A device utilizing the provisions of this paragraph 5.2(5) must have monitored all access channels defined for its system within the last 10 s and must verify, within the 20 ms (40 ms for devices designed to use a 20 ms frame period) immediately preceding actual channel access, that the detected power of the selected time and spectrum windows is no higher than the previously detected value.

The power measurement resolution bandwidth for this comparison must be accurate to within 6 dB.

No device or group of cooperating devices located within 1 m of each other shall during any frame period occupy more than 6 MHz of aggregate bandwidth, or alternatively, more than one third of the time and spectrum windows defined by the system.

(6) If the selected combined time and spectrum windows are unavailable, the device may either monitor and select different windows or seek to use the same windows after waiting an amount of time, randomly chosen from a uniform random distribution between 10 and 150 ms, commencing from the time when the channel becomes available.

(7) The monitoring system bandwidth must be equal to or greater than the occupied bandwidth of the intended transmission. Note: Testing of the monitoring system bandwidth is not required if the designed bandwidth from the manufacturer is available and given in the test report.

The maximum reaction time of the monitor shall be less than $50\sqrt{1.25/\text{occupied bandwidth in MHz}}$ μs for signals at the applicable threshold level but shall not be required to be less than 50 μs . If a signal of 6 dB or more above the threshold level is detected, the maximum reaction time shall be $35\sqrt{1.25/\text{occupied bandwidth in MHz}}$ μs but shall not be required to be less than 35 μs .

(8) The monitoring system shall use the same antenna used for transmission, or an antenna that yields equivalent reception at that location. Note: A monitoring antenna of the same model (and manufacturer) as the transmitting antenna is considered equivalent. An antenna not of the same model but of the same type (e.g. both are horn antennas of different manufacturers) is considered equivalent if the main beam antenna gains are within 3 dB of each other. Both antennas are to be installed to point at the same general coverage area.

(9) Devices that have a power output lower than the maximum permitted under this standard may increase their detection threshold by 1 dB for each 1 dB that the transmitter power is below the maximum permitted.

(10) A device initiating a communication (hereafter called an initiating device) may attempt to establish a duplex connection by monitoring both its intended transmit and receive time and spectrum windows. If both the intended transmit and receive time and spectrum windows meet the access criteria, then the initiating device can initiate a transmission in the intended transmit time and spectrum window. If the power detected by the responding device can be decoded as a duplex connection signal from the initiating device, then the responding device may immediately begin transmitting in the receive time and spectrum window monitored by the initiating device.

(11) An initiating device that is prevented from monitoring during its intended transmit window due to monitoring system blocking from the transmissions of a co-located (within 1 m) transmitter of the same system, may monitor the portions of the time and spectrum window in which they are to receive over a period of at least 10 ms.

The monitored time and spectrum window must total at least 50% of the 10 ms frame interval and the monitored spectrum must be within 1.25 MHz of the centre frequency of channel(s) already occupied by that device or co-located cooperating devices.

If the access criteria are met for the intended receive time and spectrum window under the above conditions, then transmission in the intended transmit window by the initiating device may commence.

(12) The provisions of paragraphs 5.2(10) and (11) shall not be used to extend the range of spectrum occupied over space or time for the purpose of denying fair access to spectrum to other devices.

(13) The frame period (a set of consecutive time slots in which the position of each time slot can be identified by reference to a synchronizing source) of an intentional radiator operating in this sub-band shall be $20 \text{ ms}/X$ where X is a positive whole number.

Each device that implements time division for the purpose of maintaining a duplex connection on a given frequency carrier shall maintain a frame repetition rate with a frequency stability of at least 50 parts per million (ppm).

Each device that further divides access in time in order to support multiple communication links on a given frequency carrier shall maintain a frame repetition rate with a frequency stability of at least 10 ppm.

The jitter (time-related, abrupt, spurious variations in the duration of the frame interval) introduced at the 2 ends of such a communication link shall not exceed $25 \mu\text{s}$ for any 2 consecutive transmissions.

Transmissions shall be continuous in every time and spectrum window during the frame period defined for the device.

3.7.2 EUT Setup

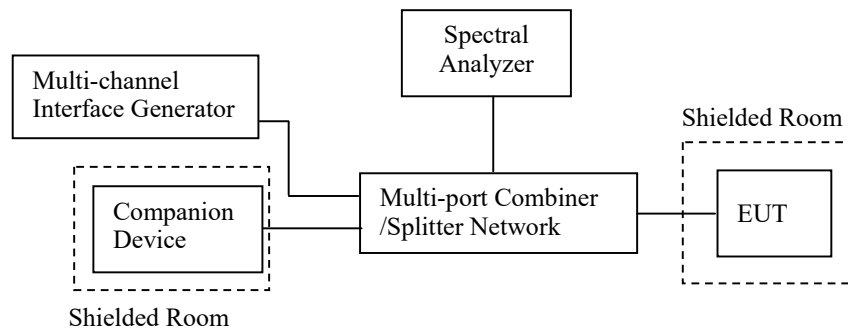

3.7.3 Test Procedure

1) Monitoring Time

According to ANSI C63.17- 2013 Section 7.3.3

2) Lower Monitoring Threshold

According to ANSI C63.17- 2013 Section 7.3.1

3) Maximum Transmit Period

According to ANSI C63.17- 2013 Section 8.2.2

4) System Acknowledgement

According to ANSI C63.17- 2013 Section 8.1, 8.2

5) Least Interfered Channel (LIC)

According to ANSI C63.17- 2013 Section 7.3.2, 7.3.3

6) Random waiting

According to ANSI C63.17- 2013 Section 8.1.2 or 8.1.3

7) Monitoring Bandwidth and Reaction Time

According to ANSI C63.17- 2013 Section 7.4, 7.5

8) Monitoring Antenna

According to ANSI C63.17- 2013 Section 4

9) Monitoring threshold relaxation

According to ANSI C63.17- 2013 Section 4

10) Duplex Connections

According to ANSI C63.17- 2013 Section 8.3

11) Alternative monitoring interval

According to ANSI C63.17- 2013 Section 8.4

12) Frame Repetition Stability Frame Period and Jitter

According to ANSI C63.17- 2013 Section 6.2.2, 6.2.3

3.8 Antenna Requirement

3.8.1 Applicable Standard

FCC §15.203

An intentional radiator shall be designed to ensure that no antenna other than that furnished by the responsible party shall be used with the device. The use of a permanently attached antenna or of an antenna that uses a unique coupling to the intentional radiator shall be considered sufficient to comply with the provisions of this section. The manufacturer may design the unit so that a broken antenna can be replaced by the user, but the use of a standard antenna jack or electrical connector is prohibited. This requirement does not apply to carrier current devices or to devices operated under the provisions of §§15.211, 15.213, 15.217, 15.219, 15.221, or §15.236. Further, this requirement does not apply to intentional radiators that must be professionally installed, such as perimeter protection systems and some field disturbance sensors, or to other intentional radiators which, in accordance with §15.31(d), must be measured at the installation site. However, the installer shall be responsible for ensuring that the proper antenna is employed so that the limits in this part are not exceeded.

RSS-GEN Clause 6.8

The applicant for equipment certification shall provide a list of all antenna types that may be used with the transmitter, where applicable (i.e. for transmitters with detachable antenna), indicating the maximum permissible antenna gain (in dBi) and the required impedance for each antenna. The test report shall demonstrate the compliance of the transmitter with the limit for maximum equivalent isotropically radiated power (e.i.r.p.) specified in the applicable RSS, when the transmitter is equipped with any antenna type, selected from this list.

For expediting the testing, measurements may be performed using only the antenna with highest gain of each combination of transmitter and antenna type, with the transmitter output power set at the maximum level. However, the transmitter shall comply with the applicable requirements under all operational conditions and when in combination with any type of antenna from the list provided in the test report (and in the notice to be included in the user manual, provided below).

When measurements at the antenna port are used to determine the RF output power, the effective gain of the device's antenna shall be stated, based on a measurement or on data from the antenna's manufacturer.

The test report shall state the RF power, output power setting and spurious emission measurements with each antenna type that is used with the transmitter being tested.

For licence-exempt equipment with detachable antennas, the user manual shall also contain the following notice in a conspicuous location:

This radio transmitter [enter the device's ISED certification number] has been approved by Innovation, Science and Economic Development Canada to operate with the antenna types listed below, with the maximum permissible gain indicated. Antenna types not included in this list that have a gain greater than the maximum gain indicated for any type listed are strictly prohibited for use with this device.

Immediately following the above notice, the manufacturer shall provide a list of all antenna types which can be used with the transmitter, indicating the maximum permissible antenna gain (in dBi) and the required impedance for each antenna type.

3.8.2 Judgment

Compliant. Please refer to the Antenna Information detail in Section 1.

4. Test DATA AND RESULTS

4.1 Conducted Emissions

Serial Number:	22O3_2	Test Date:	2023/3/18-2023/4/14
Test Site:	CE	Test Mode:	Transmitting(Middle channel was the worst)
Tester:	Vic Du	Test Result:	Pass

Environmental Conditions:

Temperature: (°C)	23.2-24.5	Relative Humidity: (%)	65-70	ATM Pressure: (kPa)	100.5-101.3
----------------------	-----------	---------------------------	-------	------------------------	-------------

Test Equipment List and Details:

Manufacturer	Description	Model	Serial Number	Calibration Date	Calibration Due Date
R&S	LISN	ENV216	101134	2023/03/31	2024/03/30
R&S	LISN	ENV216	101134	2022/03/31	2023/03/30
R&S	EMI Test Receiver	ESR3	102726	2022/07/15	2023/07/14
MICRO-COAX	Coaxial Cable	UTIFLEX	C-0200-01	2022/08/07	2023/08/06
Audix	Test Software	E3	190306 (V9)	N/A	N/A

* Statement of Traceability: China Certification ICT Co., Ltd (Dongguan) attests that all calibrations have been performed, traceable to National Primary Standards and International System of Units (SI).

Adapter 1:

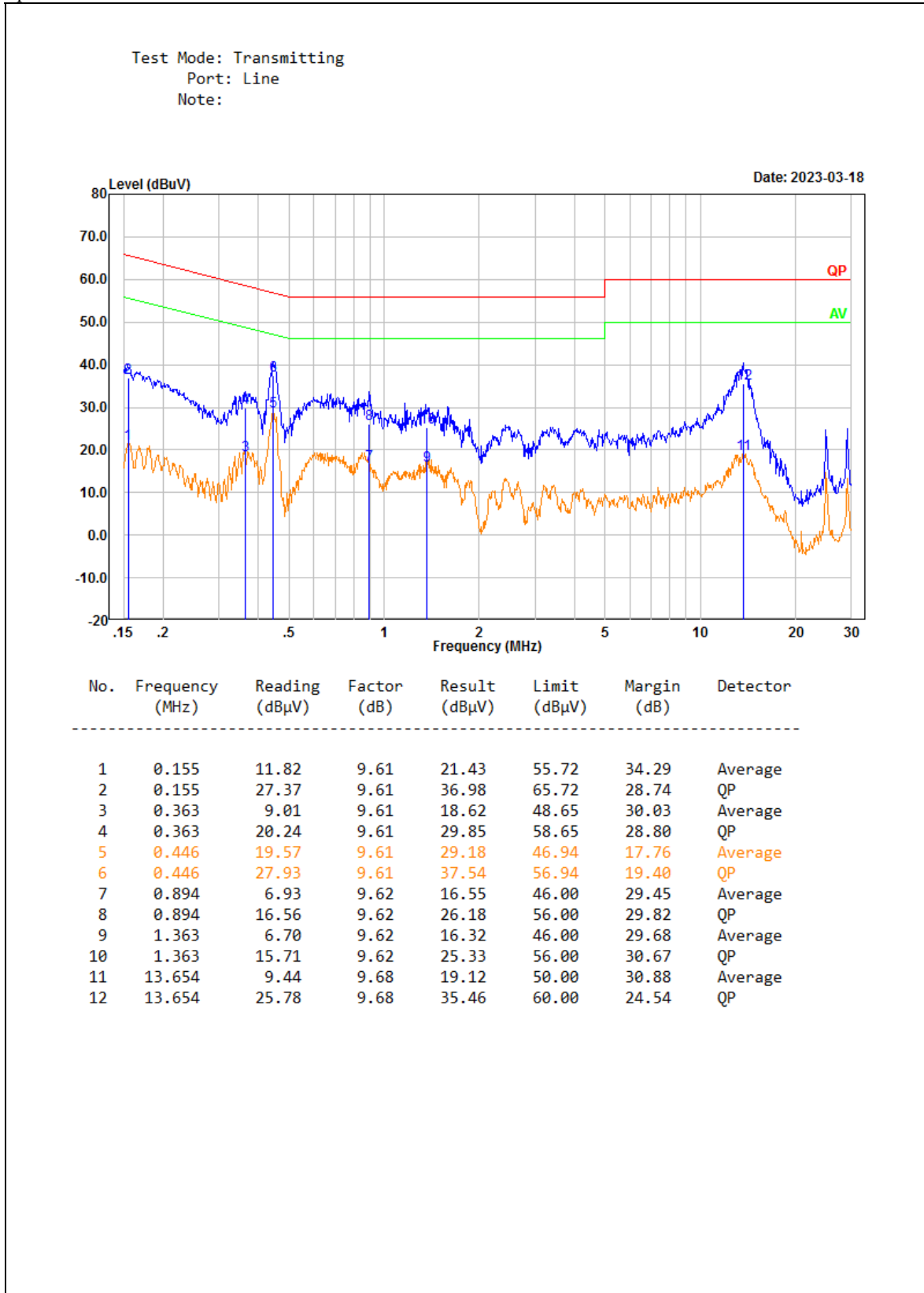

Test Mode: Transmitting
 Port: neutral
 Note:

Date: 2023-03-18

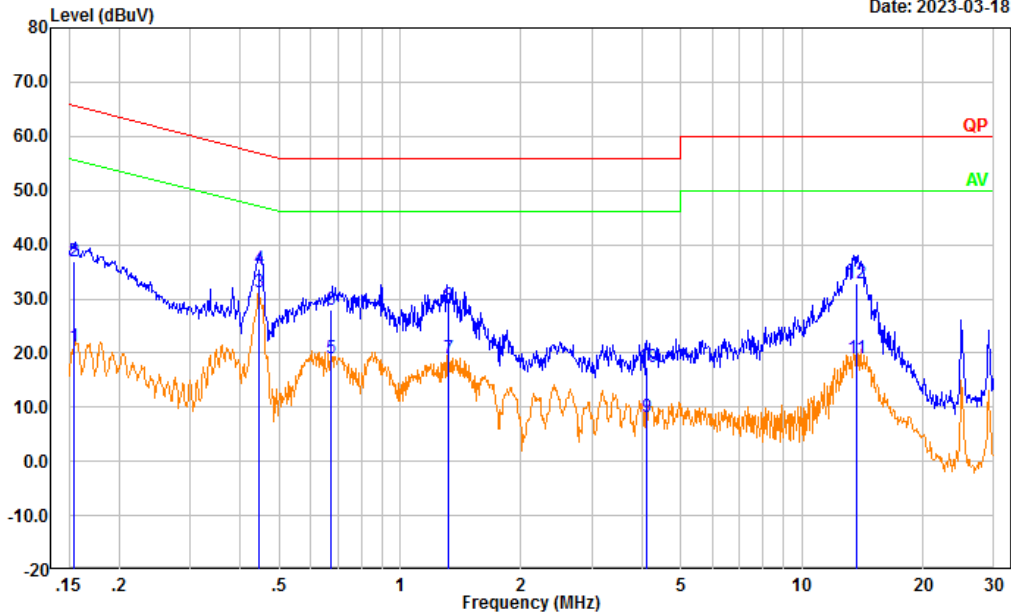

No.	Frequency (MHz)	Reading (dBμV)	Factor (dB)	Result (dBμV)	Limit (dBμV)	Margin (dB)	Detector
1	0.154	11.72	9.61	21.33	55.78	34.45	Average
2	0.154	27.18	9.61	36.79	65.78	28.99	QP
3	0.446	21.54	9.61	31.15	46.96	15.81	Average
4	0.446	25.95	9.61	35.56	56.96	21.40	QP
5	0.673	9.35	9.62	18.97	46.00	27.03	Average
6	0.673	18.28	9.62	27.90	56.00	28.10	QP
7	1.324	9.51	9.62	19.13	46.00	26.87	Average
8	1.324	19.06	9.62	28.68	56.00	27.32	QP
9	4.102	-1.58	9.65	8.07	46.00	37.93	Average
10	4.102	7.69	9.65	17.34	56.00	38.66	QP
11	13.617	9.29	9.68	18.97	50.00	31.03	Average
12	13.617	23.11	9.68	32.79	60.00	27.21	QP

Adapter 2:

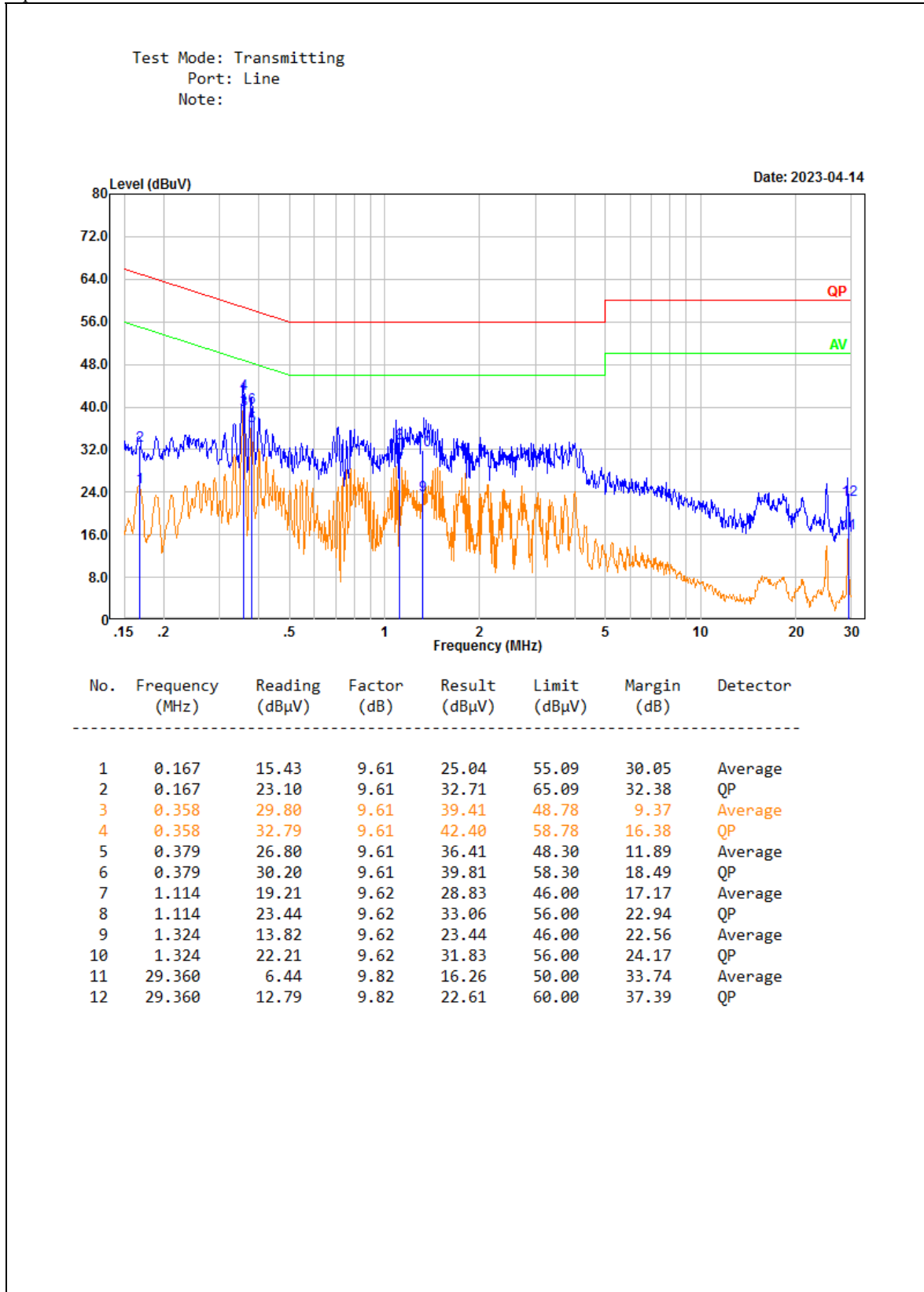

Test Mode: Transmitting
 Port: neutral
 Note:

Date: 2023-04-14

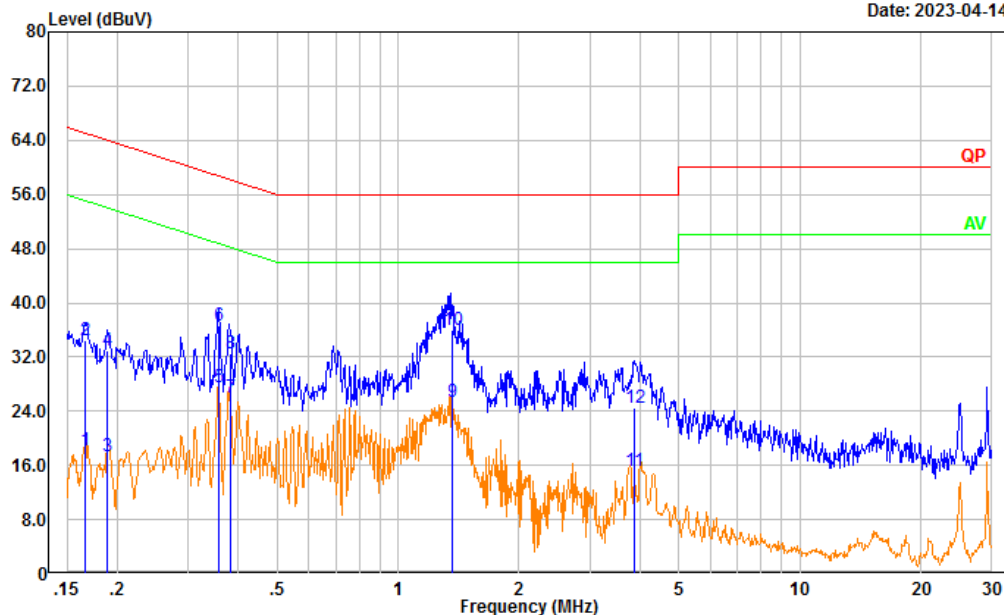

No.	Frequency (MHz)	Reading (dBμV)	Factor (dB)	Result (dBμV)	Limit (dBμV)	Margin (dB)	Detector
1	0.167	8.51	9.61	18.12	55.10	36.98	Average
2	0.167	24.87	9.61	34.48	65.10	30.62	QP
3	0.189	7.68	9.61	17.29	54.08	36.79	Average
4	0.189	23.37	9.61	32.98	64.08	31.10	QP
5	0.357	17.96	9.61	27.57	48.79	21.22	Average
6	0.357	27.02	9.61	36.63	58.79	22.16	QP
7	0.382	16.34	9.61	25.95	48.24	22.29	Average
8	0.382	22.84	9.61	32.45	58.24	25.79	QP
9	1.360	15.74	9.62	25.36	46.00	20.64	Average
10	1.360	26.29	9.62	35.91	56.00	20.09	QP
11	3.873	5.53	9.65	15.18	46.00	30.82	Average
12	3.873	14.95	9.65	24.60	56.00	31.40	QP

4.2 Emission Bandwidth:

Serial Number:	2203_2	Test Date:	2023/3/18
Test Site:	RF	Test Mode:	Transmitting
Tester:	Sugar Xie	Test Result:	Pass

Environmental Conditions:

Temperature: (°C)	27.9	Relative Humidity: (%)	55	ATM Pressure: (kPa)	101
----------------------	------	---------------------------	----	------------------------	-----

Test Equipment List and Details:

Manufacturer	Description	Model	Serial Number	Calibration Date	Calibration Due Date
R&S	Spectrum Analyzer	FSV40	101474	2022/7/15	2023/7/14
zhuoxiang	Coaxial Cable	SMA-178	211001	Each time	N/A
YINSAIGE	Coaxial Cable	SS402	SJ0100001	Each time	N/A
Mini-Circuits	DC Block	BLK-18-S+	6155/10/22	Each time	N/A
Weinschel	Power Splitter	1515	RA914	Each time	N/A
R&S	Digital Radio communication Tester	CMD 60M	846956/010	2022/4/1	2023/3/31

* Statement of Traceability: China Certification ICT Co., Ltd (Dongguan) attests that all calibrations have been performed, traceable to National Primary Standards and International System of Units (SI).

Test Data:

Test Channel	Test Frequency (MHz)	99% Emission Bandwidth (MHz)	26 dB Emission Bandwidth (MHz)	Limit (MHz)
Lowest	1921.536	1.196	1.387	50 kHz ~ 2.5 MHz
Middle	1924.992	1.196	1.461	50 kHz ~ 2.5 MHz
Highest	1928.448	1.190	1.361	50 kHz ~ 2.5 MHz

99% Emission Bandwidth

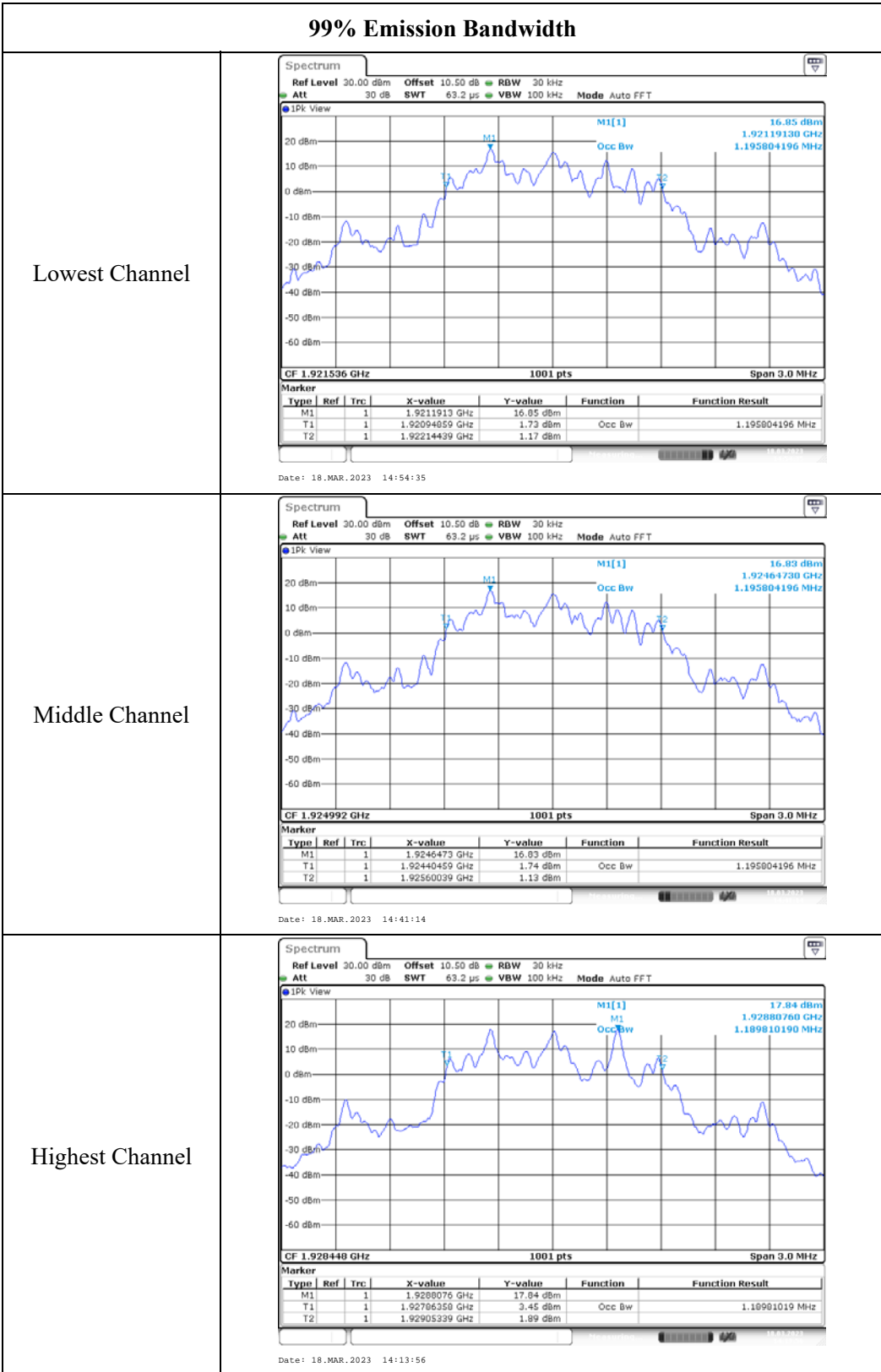

26 dB Emission Bandwidth

Lowest Channel

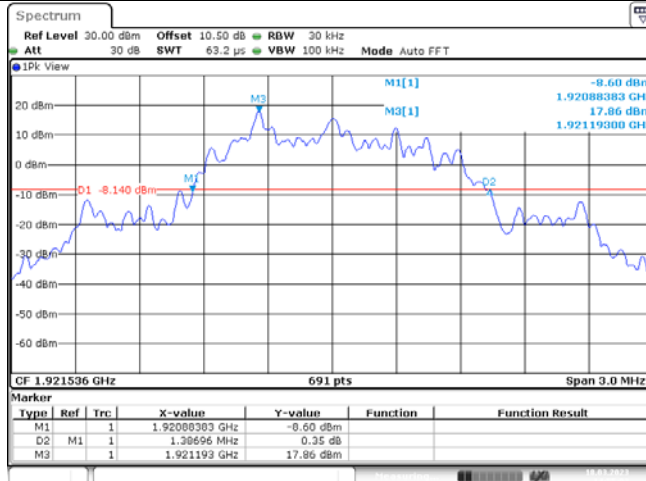

Date: 18.MAR.2023 14:55:02

Middle Channel

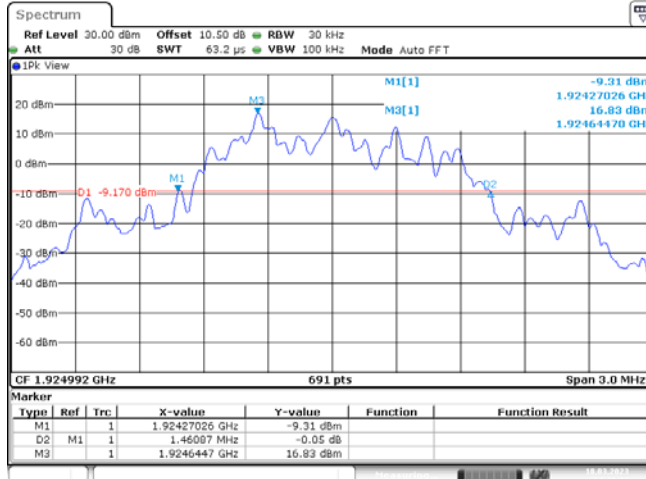

Date: 18.MAR.2023 14:41:32

Highest Channel

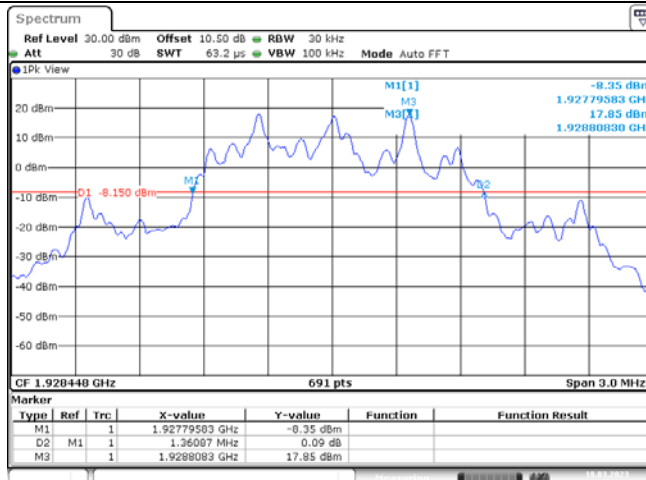

Date: 18.MAR.2023 14:14:13

4.3 Peak Transmit Power:

Serial Number:	22O3_2	Test Date:	2023/3/18
Test Site:	RF	Test Mode:	Transmitting
Tester:	Sugar Xie	Test Result:	Pass

Environmental Conditions:

Temperature: (°C)	27.9	Relative Humidity: (%)	55	ATM Pressure: (kPa)	101
----------------------	------	------------------------------	----	------------------------	-----

Test Equipment List and Details:

Manufacturer	Description	Model	Serial Number	Calibration Date	Calibration Due Date
R&S	Spectrum Analyzer	FSV40	101474	2022/7/15	2023/7/14
zhuoxiang	Coaxial Cable	SMA-178	211001	Each time	N/A
YINSAIGE	Coaxial Cable	SS402	SJ0100001	Each time	N/A
Mini-Circuits	DC Block	BLK-18-S+	6155/10/22	Each time	N/A
Weinschel	Power Splitter	1515	RA914	Each time	N/A
R&S	Digital Radio communication Tester	CMD 60M	846956/010	2022/4/1	2023/3/31

* Statement of Traceability: China Certification ICT Co., Ltd (Dongguan) attests that all calibrations have been performed, traceable to National Primary Standards and International System of Units (SI).

Test Data

Channel	Frequency (MHz)	Peak Transmit Power (dBm)	FCC Limit (dBm)	ISED Limit (dBm)
Low	1921.536	18.12	20.71	20.39
Middle	1924.992	18.14	20.82	20.39
High	1928.448	18.20	20.67	20.38

Note:

For FCC: Peak Transmit Power Limit = $100(EBW)^{1/2} \mu W$

For ISED: Peak Transmit Power Limit = $100(OBW)^{1/2} \mu W$

Peak Transmit Power

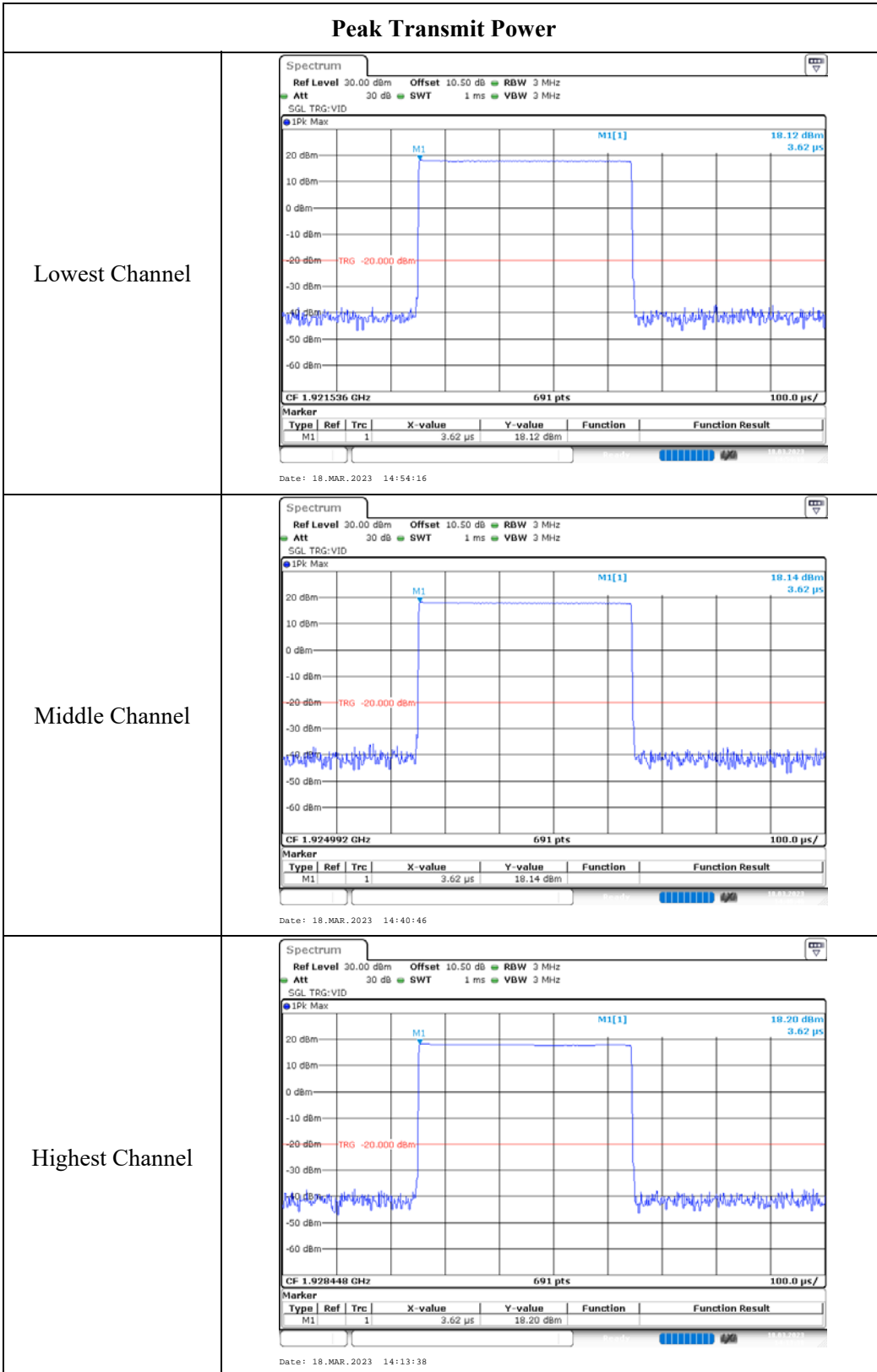

4.4 Power Spectral Density:

Serial Number:	22O3_2	Test Date:	2023/4/11
Test Site:	RF	Test Mode:	Transmitting
Tester:	Sugar Xie	Test Result:	Pass

Environmental Conditions:

Temperature: (°C)	26.5	Relative Humidity: (%)	56	ATM Pressure: (kPa)	101.1
----------------------	------	------------------------------	----	------------------------	-------

Test Equipment List and Details:

Manufacturer	Description	Model	Serial Number	Calibration Date	Calibration Due Date
R&S	Spectrum Analyzer	FSU26	200256	2022/7/15	2023/7/14
zhuoxiang	Coaxial Cable	SMA-178	211001	Each time	N/A
YINSAIGE	Coaxial Cable	SS402	SJ0100001	Each time	N/A
Mini-Circuits	DC Block	BLK-18-S+	6155/10/22	Each time	N/A
Weinschel	Power Splitter	1515	RA914	Each time	N/A
R&S	Digital Radio communication Tester	CMD 60M	846956/010	2023/4/1	2024/3/31

* Statement of Traceability: China Certification ICT Co., Ltd (Dongguan) attests that all calibrations have been performed, traceable to National Primary Standards and International System of Units (SI).

Test Data:

Channel	Frequency (MHz)	Power Spectral Density		Limit (mW/3kHz)
		(dBm/3kHz)	(mW/3kHz)	
Low	1921.536	-2.32	0.59	3
Middle	1924.992	-3.58	0.44	3
High	1928.448	-3.85	0.41	3

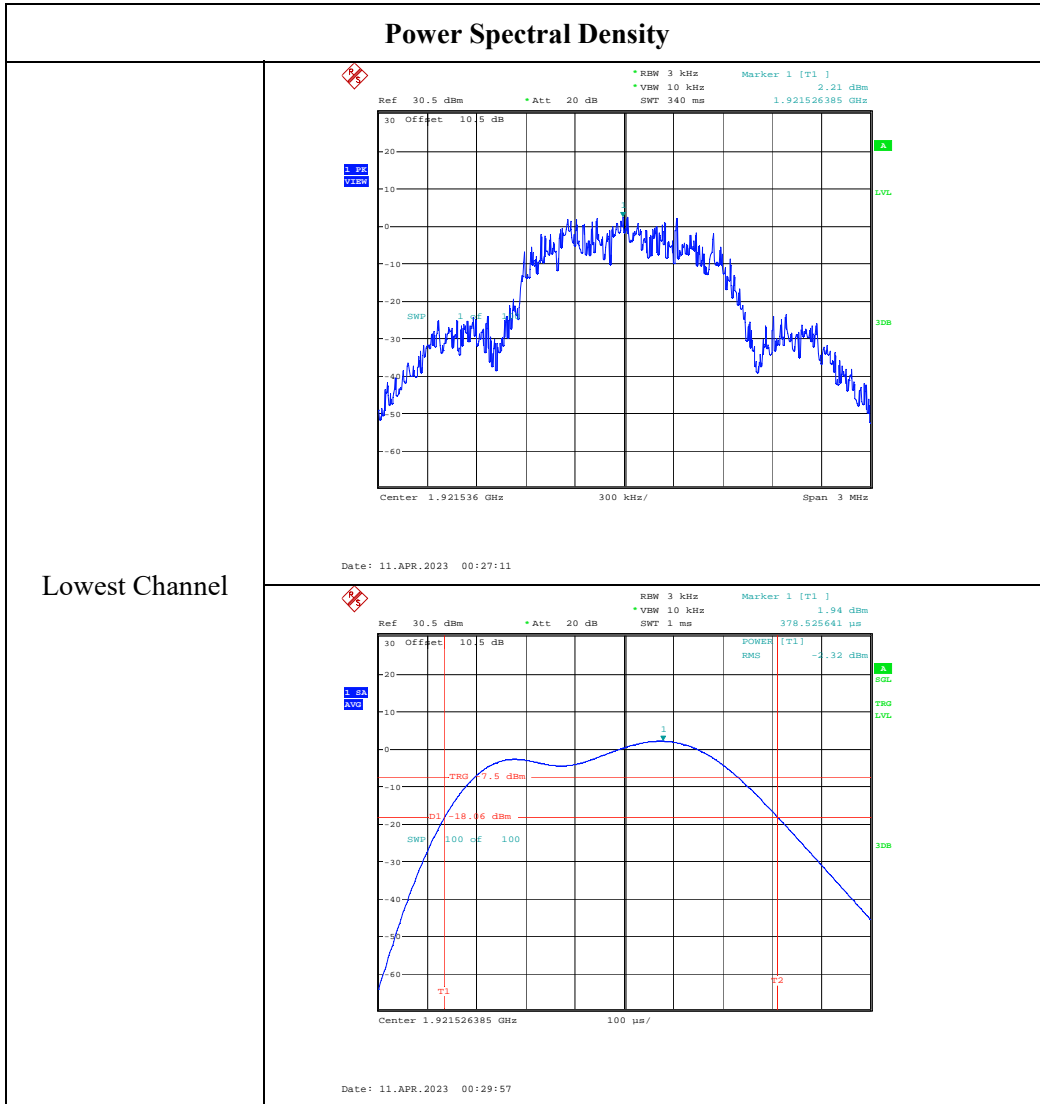

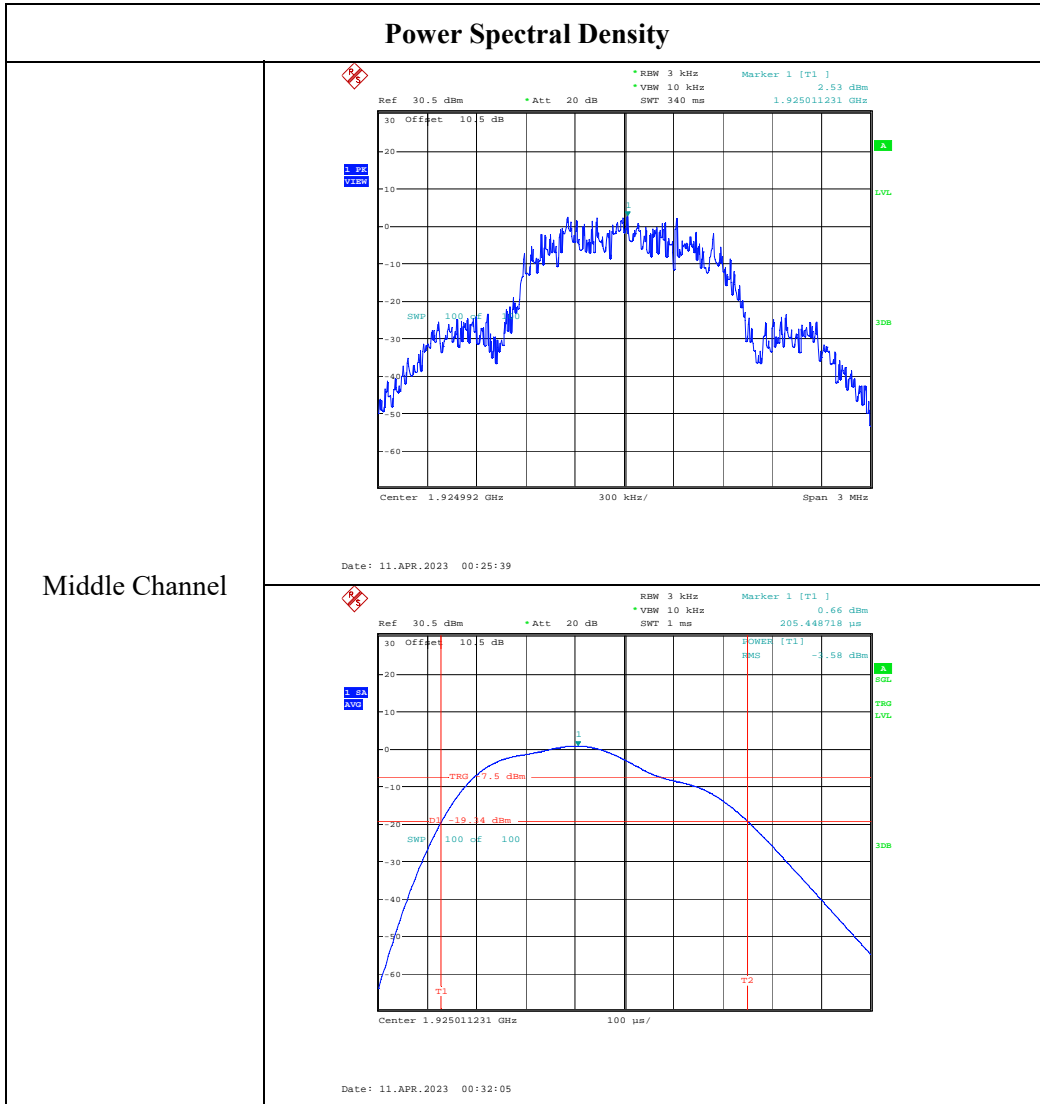

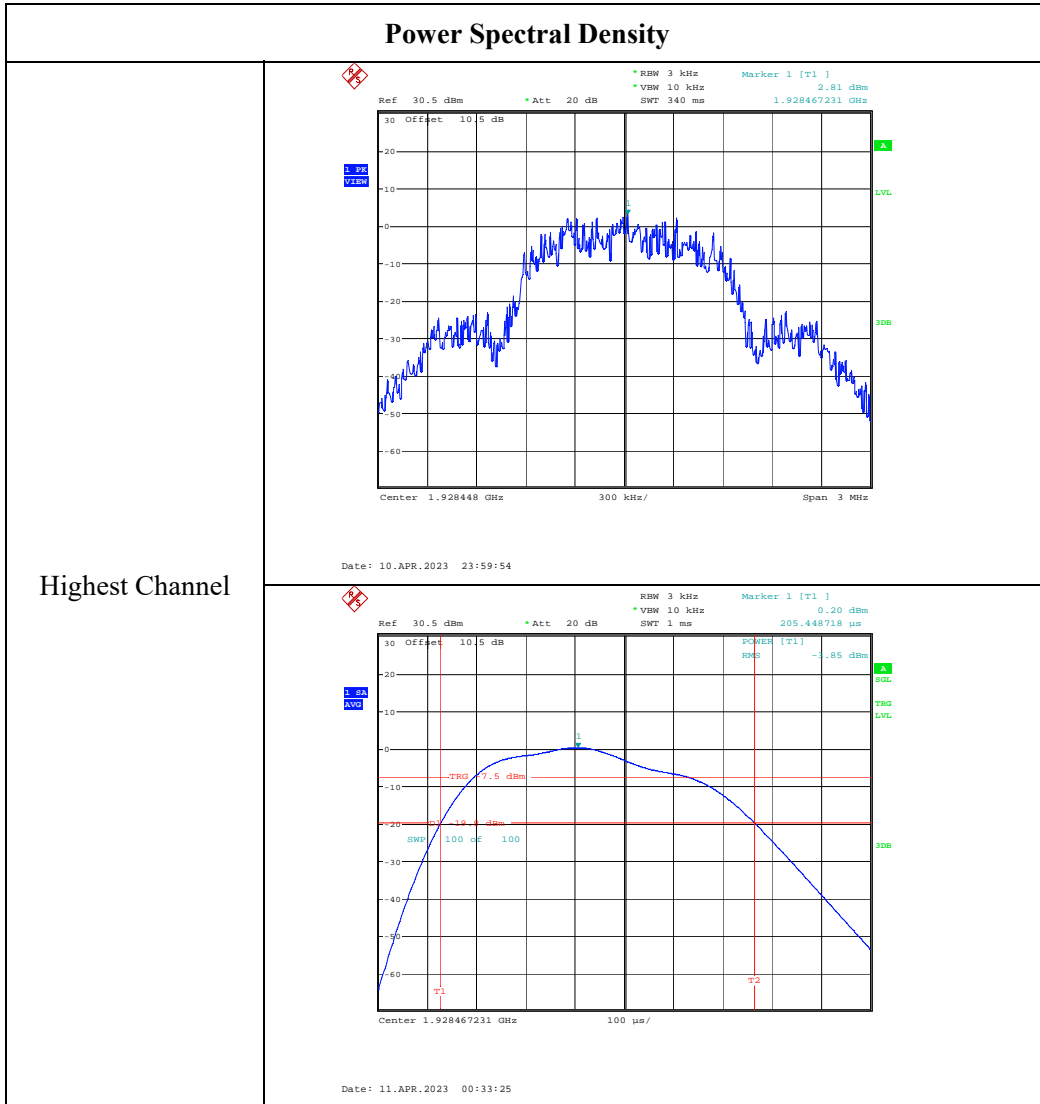

4.5 Emission Inside and Outside the Sub-band:**1) For RF Conducted Emission:**

Serial Number:	22O3_2	Test Date:	2023/3/18~2023/4/25
Test Site:	RF	Test Mode:	Transmitting
Tester:	Sugar Xie	Test Result:	Pass

Environmental Conditions:

Temperature: (°C)	25.9~27.9	Relative Humidity: (%)	55~66	ATM Pressure: (kPa)	100.9~101
----------------------	-----------	------------------------------	-------	------------------------	-----------

Test Equipment List and Details:

Manufacturer	Description	Model	Serial Number	Calibration Date	Calibration Due Date
R&S	Spectrum Analyzer	FSV40	101474	2022/7/15	2023/7/14
zhuoxiang	Coaxial Cable	SMA-178	211001	Each time	N/A
YINSAIGE	Coaxial Cable	SS402	SJ0100001	Each time	N/A
Mini-Circuits	DC Block	BLK-18-S+	6155/10/22	Each time	N/A
Weinschel	Power Splitter	1515	RA914	Each time	N/A
R&S	Digital Radio communication Tester	CMD 60M	846956/010	2022/4/1	2023/3/31
R&S	Digital Radio communication Tester	CMD 60M	846956/010	2023/3/31	2024/3/30

* Statement of Traceability: China Certification ICT Co., Ltd (Dongguan) attests that all calibrations have been performed, traceable to National Primary Standards and International System of Units (SI).

Test Data:

FCC:

Unwanted Emission inside the Sub-band

Low Channel

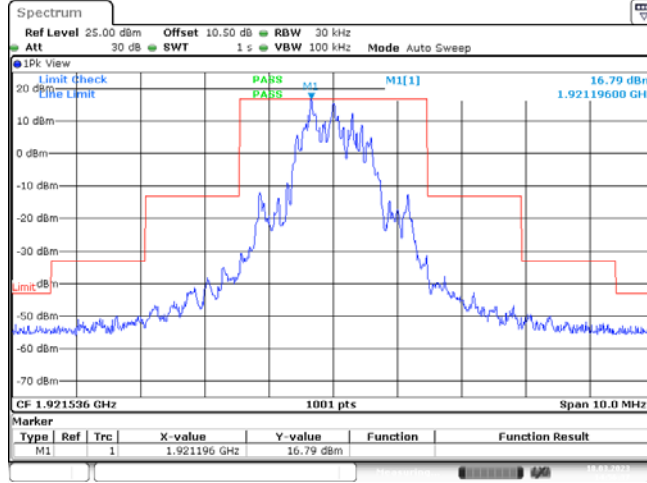

Date: 18.MAR.2023 14:56:37

Middle Channel

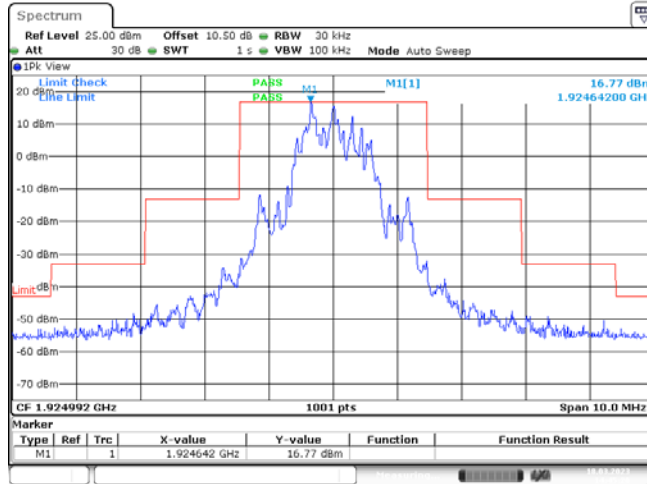

Date: 18.MAR.2023 14:45:21

High Channel

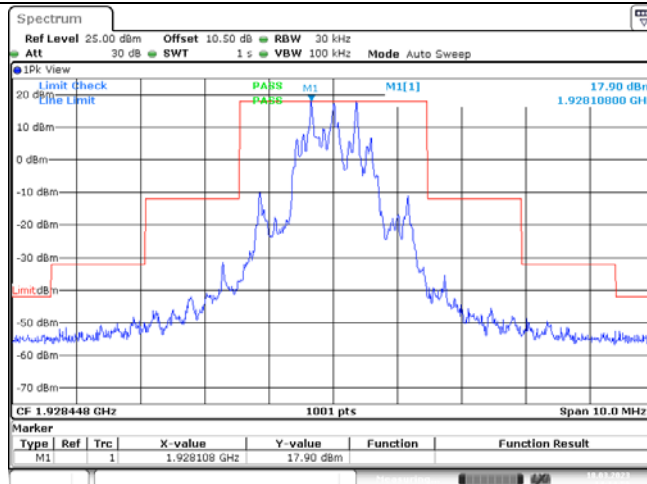

Date: 18.MAR.2023 14:14:58

ISED:

Unwanted Emission inside the Sub-band

<p>Low Channel</p>	<p>Spectrum Ref Level 25.00 dBm Offset 10.50 dB RBW 30 kHz Att 30 dB SWT 63.2 μs VBW 100 kHz Mode Auto FFT IPk View Limit check 20 dBm LIMIT PASS PASS CF 1.921536 GHz 1001 pts Span 10.0 MHz Date: 25.APR.2023 18:22:48</p>
<p>Middle Channel</p>	<p>Spectrum Ref Level 25.00 dBm Offset 10.50 dB RBW 30 kHz Att 30 dB SWT 63.2 μs VBW 100 kHz Mode Auto FFT IPk View Limit check 20 dBm LIMIT PASS PASS CF 1.924992 GHz 1001 pts Span 10.0 MHz Date: 25.APR.2023 18:16:52</p>
<p>High Channel</p>	<p>Spectrum Ref Level 25.00 dBm Offset 10.50 dB RBW 30 kHz Att 30 dB SWT 63.2 μs VBW 100 kHz Mode Auto FFT IPk View Limit check 20 dBm LIMIT PASS PASS CF 1.928448 GHz 1001 pts Span 10.0 MHz Date: 25.APR.2023 18:13:00</p>

Low Channel (Unwanted Emission outside the Sub-band)

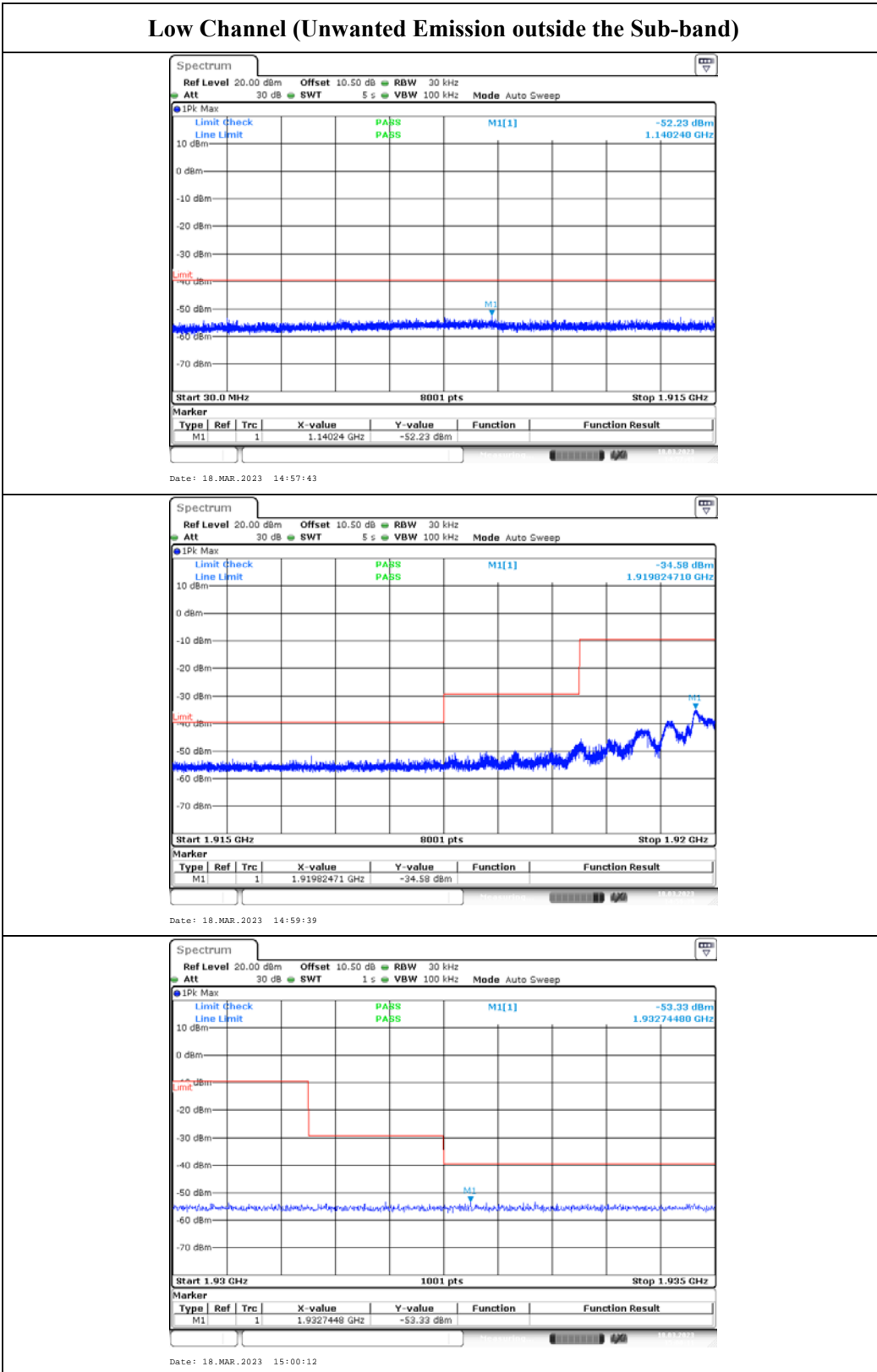

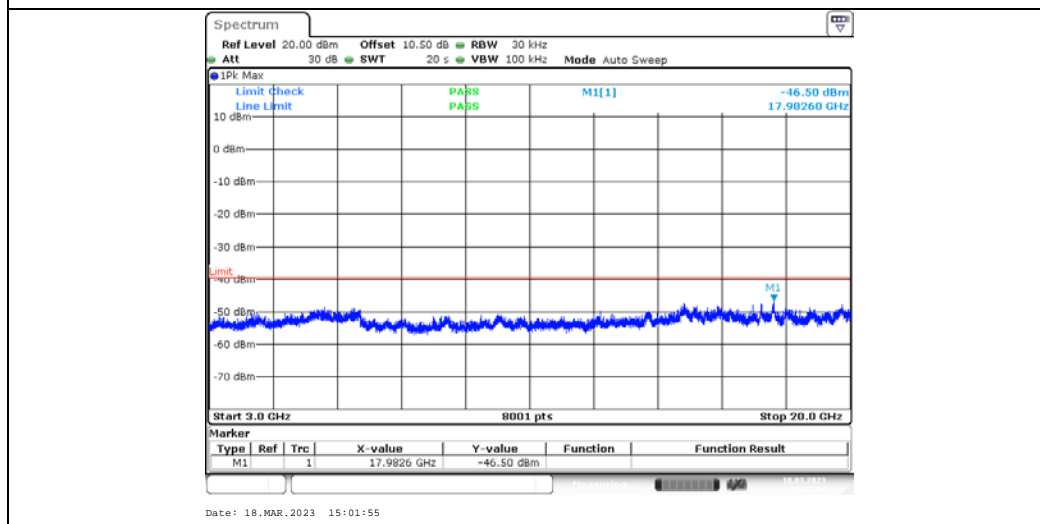
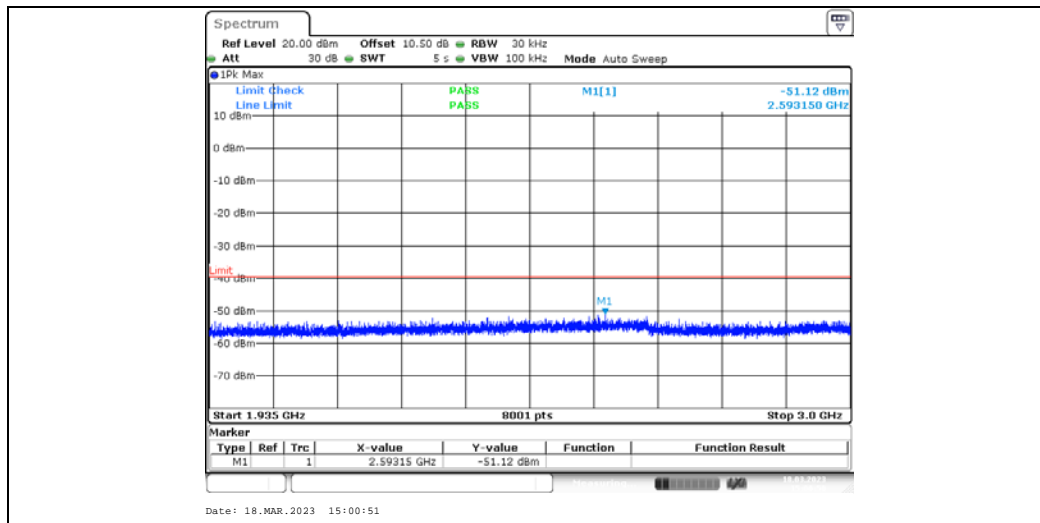

Middle Channel (Unwanted Emission outside the Sub-band)

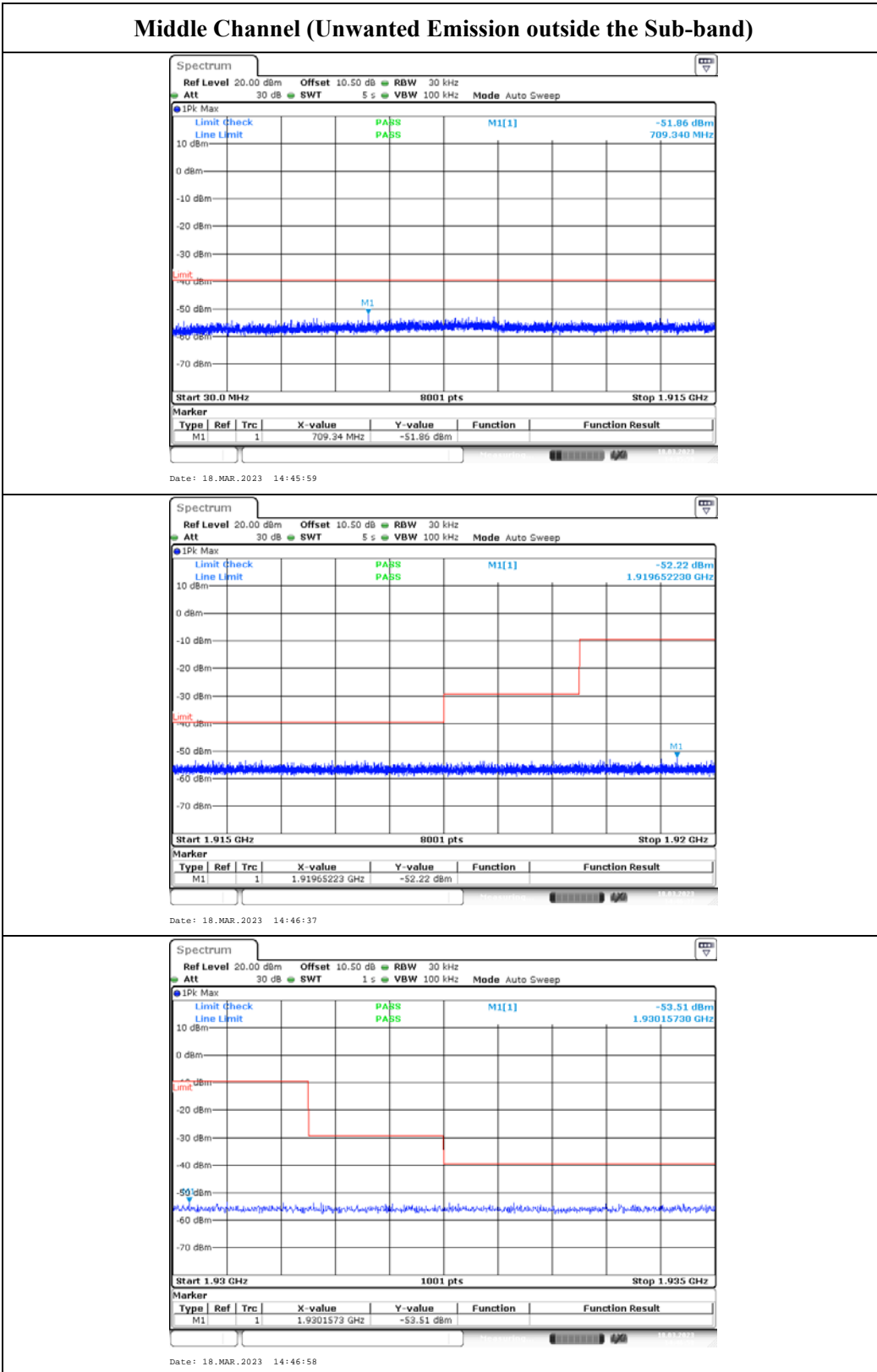

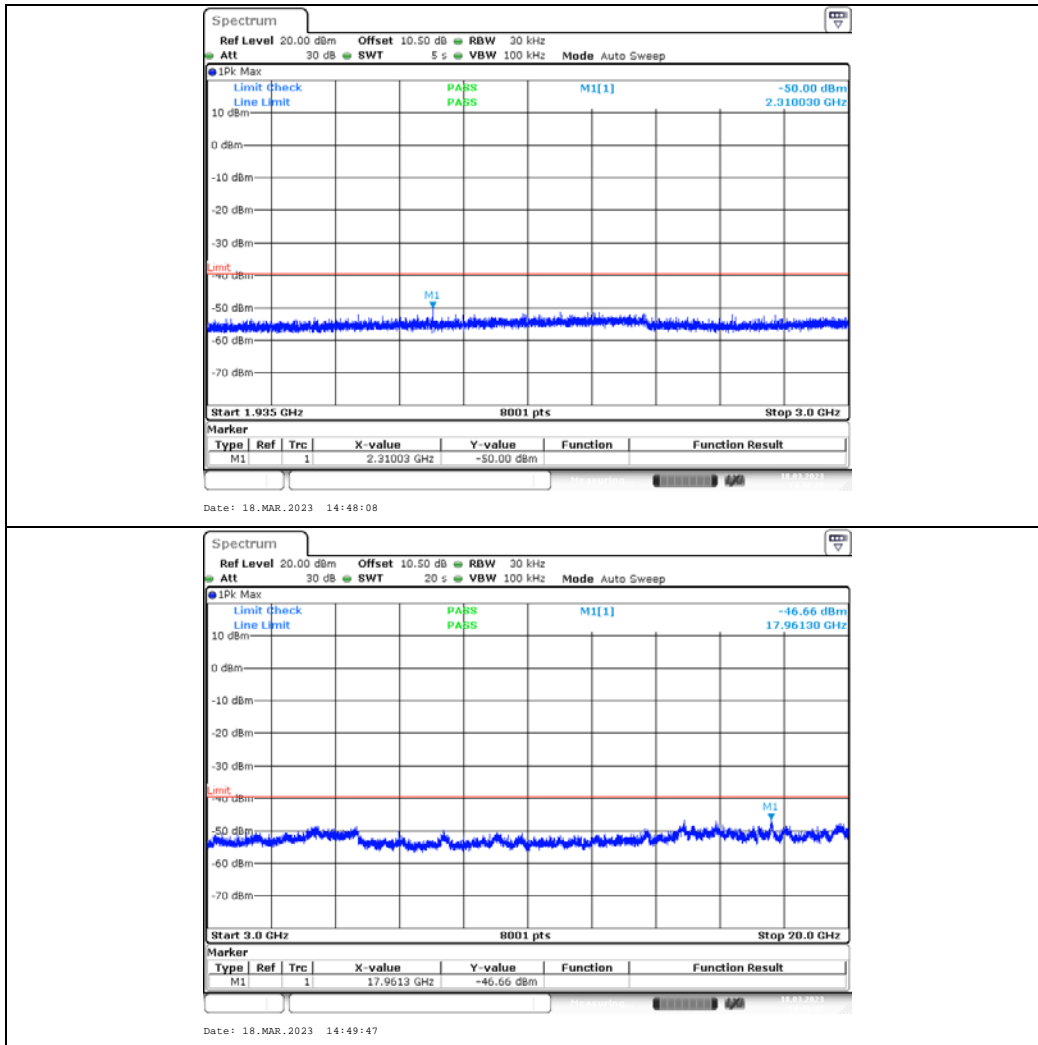

High Channel (Unwanted Emission outside the Sub-band)

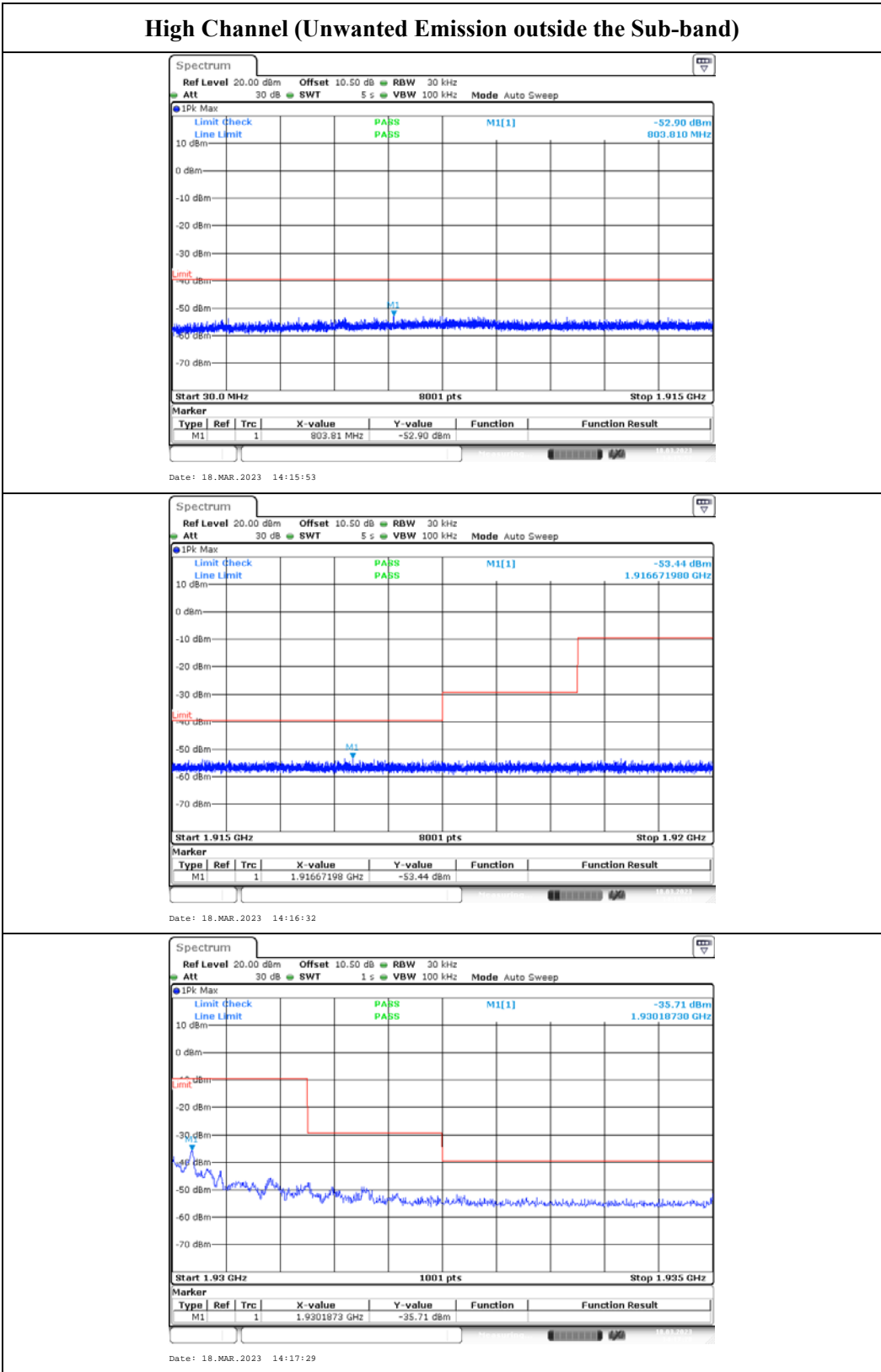

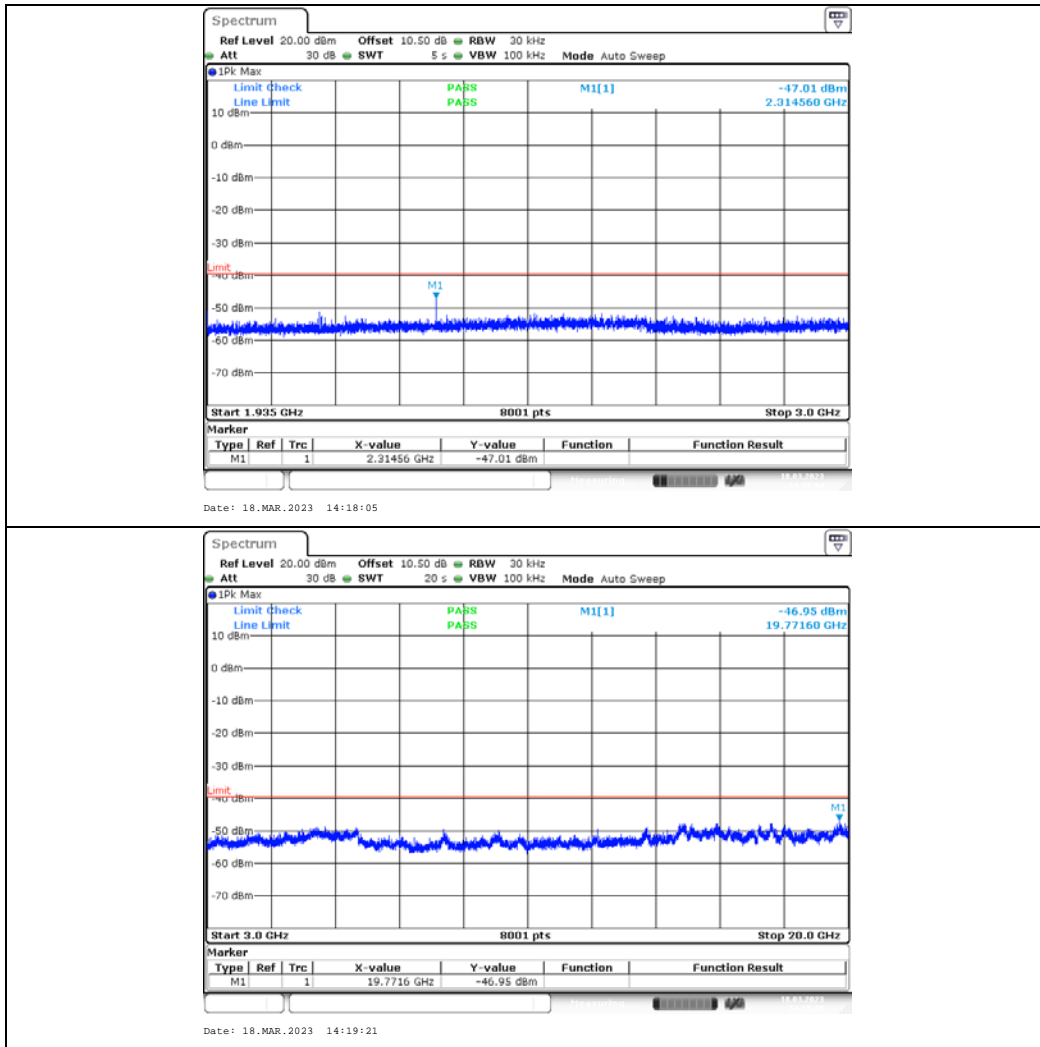

2) For Radiated Emissions:

Serial Number:	22O3_2	Test Date:	2023/3/21~2023/4/15
Test Site:	966-1,966-2	Test Mode:	Transmitting
Tester:	Vic Du, coco Tian	Test Result:	Pass

Environmental Conditions:

Temperature: (°C)	24.1~26.9	Relative Humidity: (%)	51~63	ATM Pressure: (kPa)	100.4~101.6
----------------------	-----------	---------------------------	-------	------------------------	-------------

Test Equipment List and Details:

Manufacturer	Description	Model	Serial Number	Calibration Date	Calibration Due Date
Sunol Sciences	Antenna	JB6	A082520-5	2020/10/19	2023/10/18
R&S	EMI Test Receiver	ESR3	102724	2022/7/15	2023/7/14
TIMES MICROWAVE	Coaxial Cable	LMR-600-UltraFlex	C-0470-02	2022/7/17	2023/7/16
TIMES MICROWAVE	Coaxial Cable	LMR-600-UltraFlex	C-0780-01	2022/7/17	2023/7/16
Sonoma	Amplifier	310N	186165	2022/7/17	2023/7/16
Audix	Test Software	E3	201021 (V9)	N/A	N/A
ETS-Lindgren	Horn Antenna	3115	9912-5985	2020/10/13	2023/10/12
R&S	Spectrum Analyzer	FSV40	101591	2022/7/15	2023/7/14
MICRO-COAX	Coaxial Cable	UFA210A-1-1200-70U300	217423-008	2022/8/7	2023/8/6
MICRO-COAX	Coaxial Cable	UFA210A-1-2362-300300	235780-001	2022/8/7	2023/8/6
Mini	Pre-amplifier	ZVA-183-S+	5969001149	2022/11/10	2023/11/9
PASTERNAK	Horn Antenna	PE9852/2F-20	112002	2021/2/5	2024/2/4
AH	Preamplifier	PAM-1840VH	190	2022/11/19	2023/11/18
MICRO-COAX	Coaxial Cable	UFB142A-1-2362-200200	235772-001	2022/8/7	2023/8/6

* Statement of Traceability: China Certification ICT Co., Ltd (Dongguan) attests that all calibrations have been performed, traceable to National Primary Standards and International System of Units (SI).

Test Data:

Please refer to the below table and plots.

Note: The device can be mounted in multiple orientations, test was performed with X,Y, Z Axis according to C63.10 Figure 8, the worst orientation was photographed and it's data was recorded.

1) 30MHz-1GHz (Middle channel was the worst)

Adapter 1#:

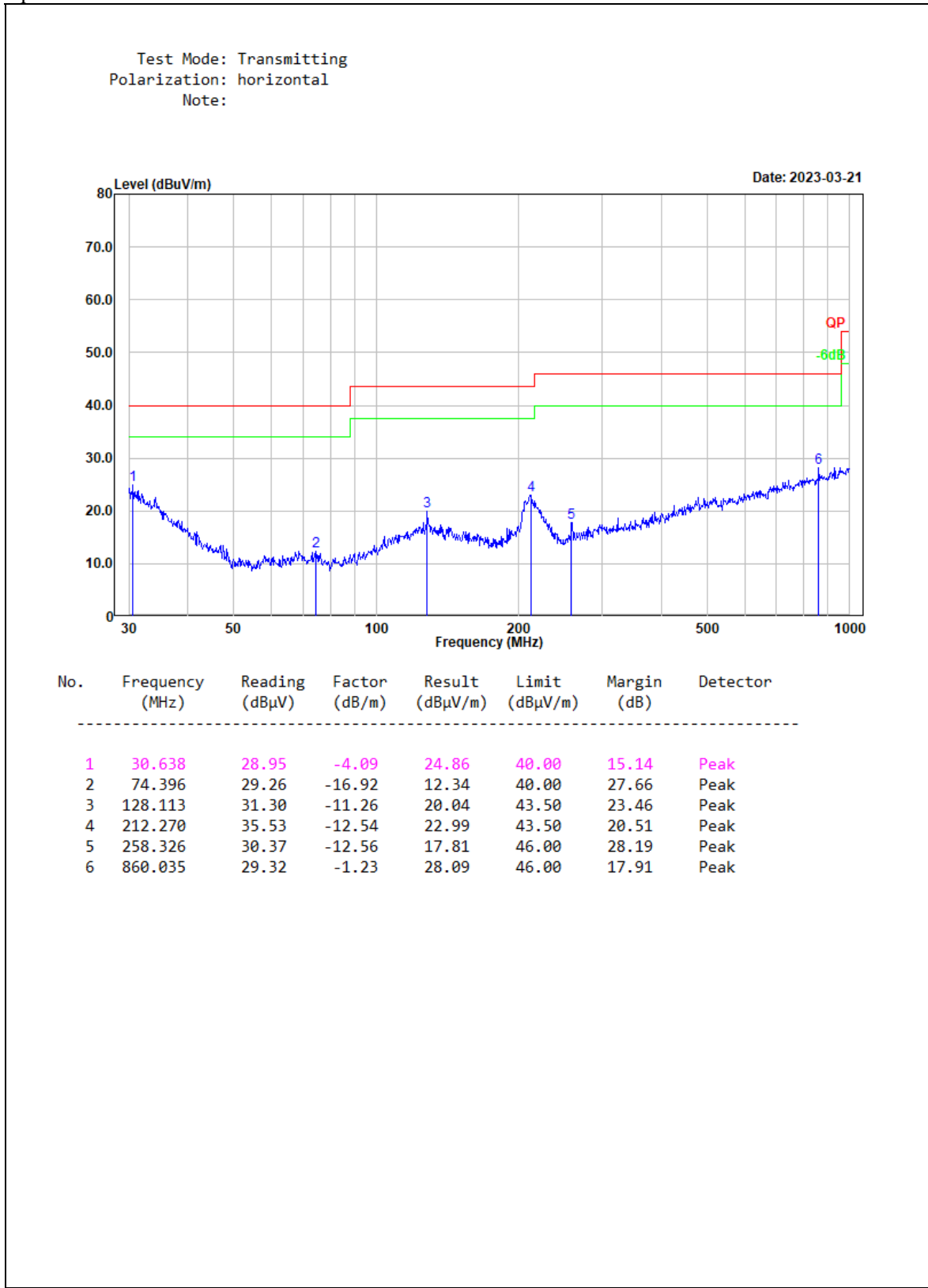

Test Mode: Transmitting
 Polarization: vertical
 Note:

Date: 2023-03-21

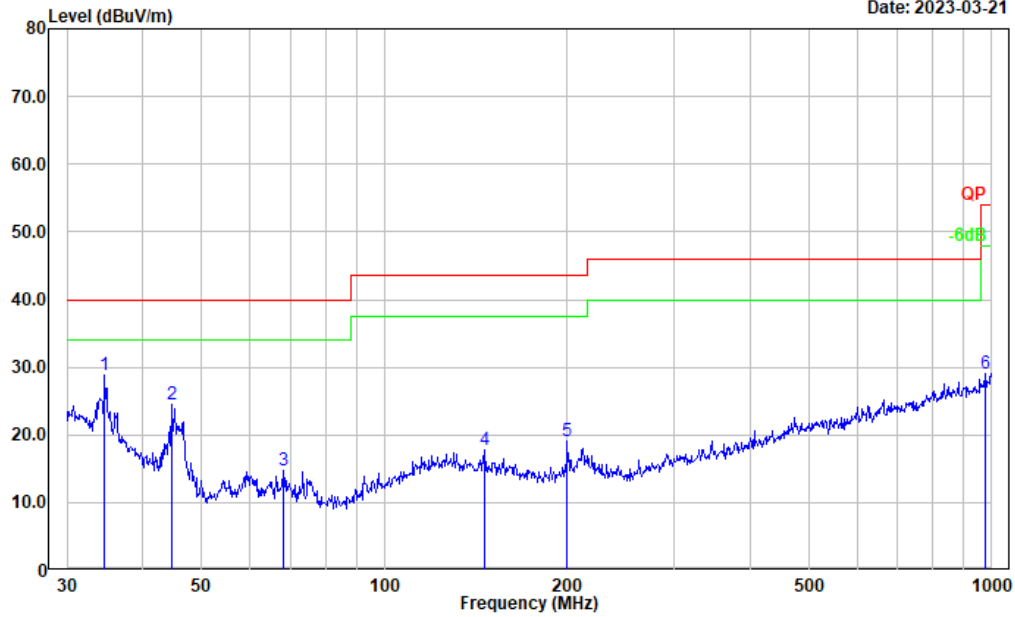

No.	Frequency (MHz)	Reading (dBμV)	Factor (dB/m)	Result (dBμV/m)	Limit (dBμV/m)	Margin (dB)	Detector
1	34.639	36.02	-7.19	28.83	40.00	11.17	Peak
2	44.743	38.54	-14.08	24.46	40.00	15.54	Peak
3	68.151	31.35	-16.67	14.68	40.00	25.32	Peak
4	146.374	29.68	-11.98	17.70	43.50	25.80	Peak
5	199.986	31.24	-12.21	19.03	43.50	24.47	Peak
6	975.753	28.69	0.40	29.09	54.00	24.91	Peak

Adapter 2#:

Test Mode: Transmitting
 Polarization: horizontal
 Note:

Date: 2023-04-15

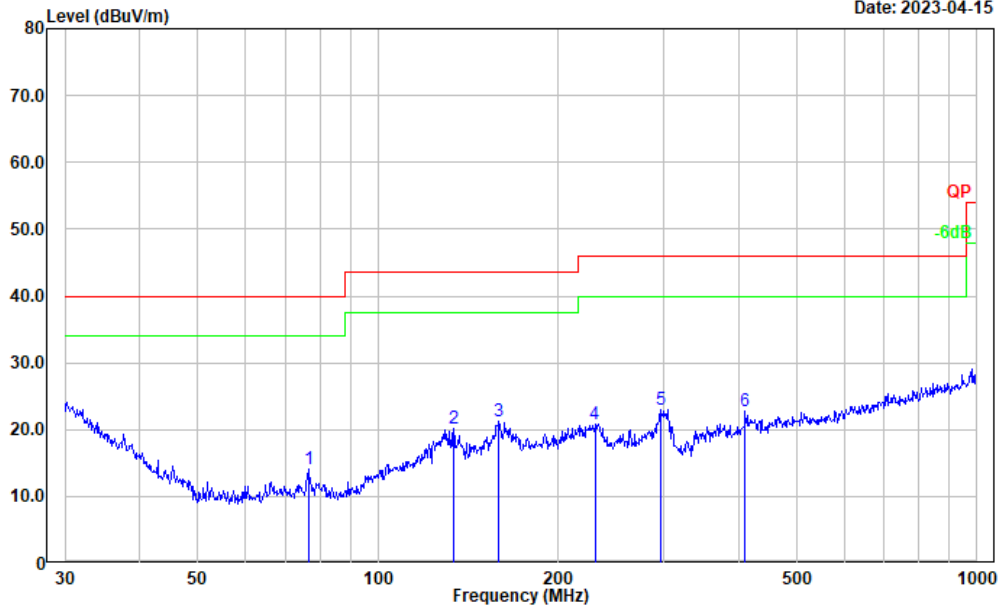

No.	Frequency (MHz)	Reading (dB μ V)	Factor (dB/m)	Result (dB μ V/m)	Limit (dB μ V/m)	Margin (dB)	Detector
1	76.512	31.24	-17.09	14.15	40.00	25.85	Peak
2	133.619	31.62	-11.55	20.07	43.50	23.43	Peak
3	159.225	33.24	-12.06	21.18	43.50	22.32	Peak
4	230.099	33.82	-12.99	20.83	46.00	25.17	Peak
5	297.224	33.73	-10.71	23.02	46.00	22.98	Peak
6	410.383	31.08	-8.36	22.72	46.00	23.28	Peak

Test Mode: Transmitting
 Polarization: vertical
 Note:

Date: 2023-04-15

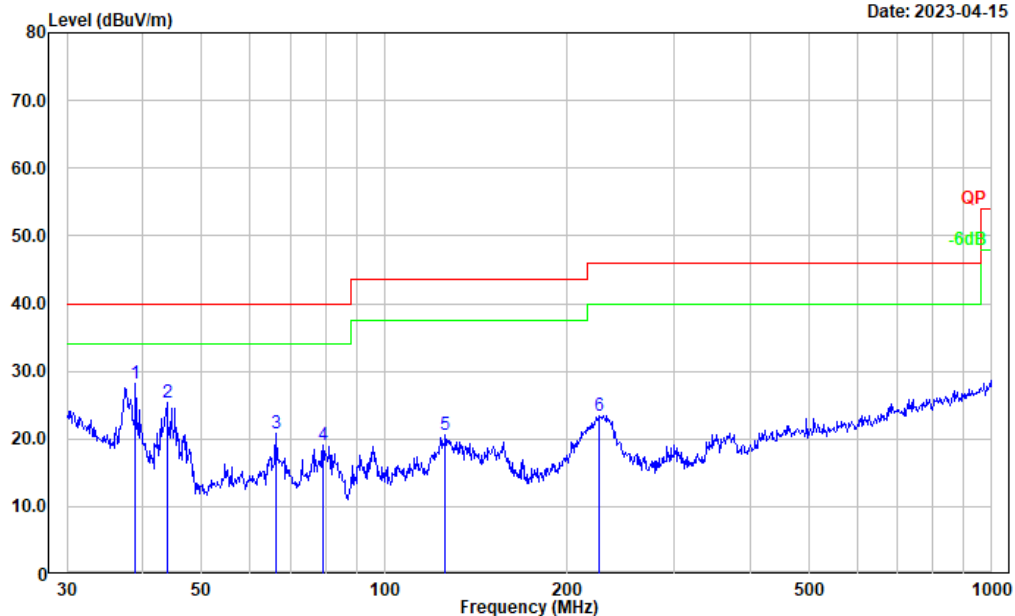

No.	Frequency (MHz)	Reading (dBμV)	Factor (dB/m)	Result (dBμV/m)	Limit (dBμV/m)	Margin (dB)	Detector
1	38.888	38.60	-10.43	28.17	40.00	11.83	Peak
2	43.812	38.86	-13.56	25.30	40.00	14.70	Peak
3	66.266	37.58	-16.84	20.74	40.00	19.26	Peak
4	79.243	36.35	-17.37	18.98	40.00	21.02	Peak
5	125.886	31.82	-11.30	20.52	43.50	22.98	Peak
6	225.308	36.30	-12.87	23.43	46.00	22.57	Peak

1) 1-20GHz (Adapter 1# was the worst):**Peak Field Strength**

Frequency (MHz)	Receiver		Polar (H/V)	Factor (dB/m)	Result (dB μ V/m)	Limit (dB μ V/m)	Margin (dB)
	Reading (dB μ V)	Detector					
Low Channel: 1921.536 MHz							
1921.536	72.25	PK	H	29.91	102.16	N/A	N/A
1921.536	82.88	PK	V	29.91	112.79	N/A	N/A
3843.072	35.24	PK	H	8.80	44.04	74.00	29.96
3843.072	56.34	PK	V	8.80	65.14	74.00	8.86
Middle Channel: 1924.992 MHz							
1924.992	72.48	PK	H	29.92	102.40	N/A	N/A
1924.992	83.11	PK	V	29.92	113.03	N/A	N/A
3849.984	41.60	PK	H	8.81	50.41	74.00	23.59
3849.984	56.62	PK	V	8.81	65.43	74.00	8.57
High Channel: 1928.448 MHz							
1928.448	72.23	PK	H	29.94	102.17	N/A	N/A
1928.448	83.61	PK	V	29.94	113.55	N/A	N/A
3856.896	35.75	PK	H	8.84	44.59	74.00	29.41
3856.896	56.48	PK	V	8.84	65.32	74.00	8.68

Average Field Strength

Frequency (MHz)	Peak (dB μ V/m)	Polar (H/V)	Duty Cycle Factor (dB)	Result (dB μ V/m)	Limit (dB μ V/m)	Margin (dB)
Low Channel: 1921.536 MHz						
1921.536	102.16	H	-28.20	73.96	N/A	N/A
1921.536	112.79	V	-28.20	84.59	N/A	N/A
3843.072	44.04	H	-28.20	15.84	54	38.16
3843.072	65.14	V	-28.20	36.94	54	17.06
Middle Channel: 1924.992 MHz						
1924.992	102.40	H	-28.20	74.20	N/A	N/A
1924.992	113.03	V	-28.20	84.83	N/A	N/A
3849.984	50.41	H	-28.20	22.21	54	31.79
3849.984	65.43	V	-28.20	37.23	54	16.77
High Channel: 1928.448 MHz						
1928.448	102.17	H	-28.20	73.97	N/A	N/A
1928.448	113.55	V	-28.20	85.35	N/A	N/A
3856.896	44.59	H	-28.20	16.39	54	37.61
3856.896	65.32	V	-28.20	37.12	54	16.88

Average level= Peak level+ Duty Cycle Factor

Duty cycle:

Ton1 =0.391ms

Tp = 10.044ms

Duty cycle = Ton/Tp = 0.391/10.044=0.0389

Duty Cycle Corrected Factor = 20lg (Duty cycle) = 20lg0.0389= -28.20

Duty Cycle

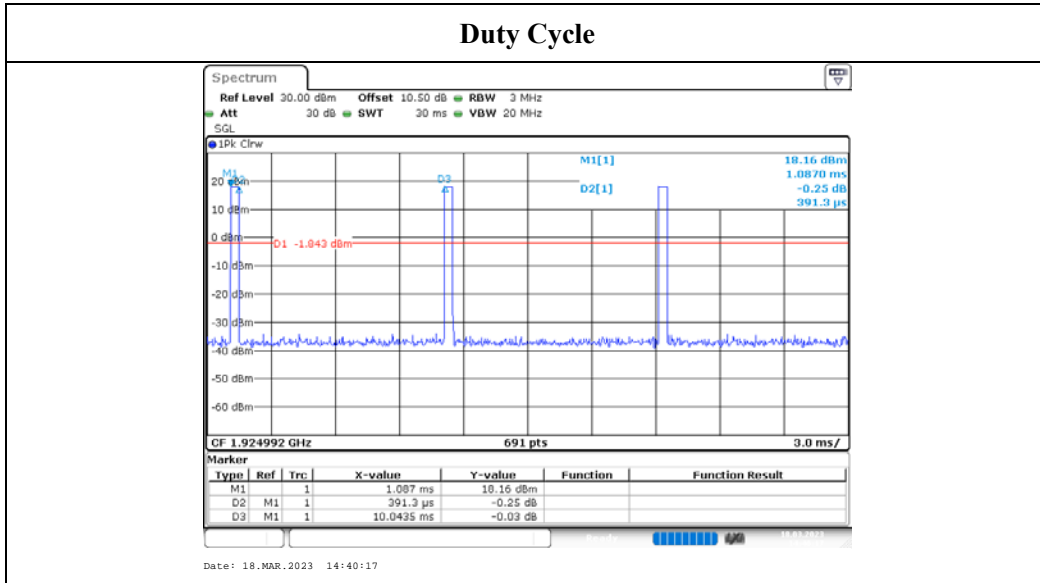

Worst Test plots(Middle channel was the worst)

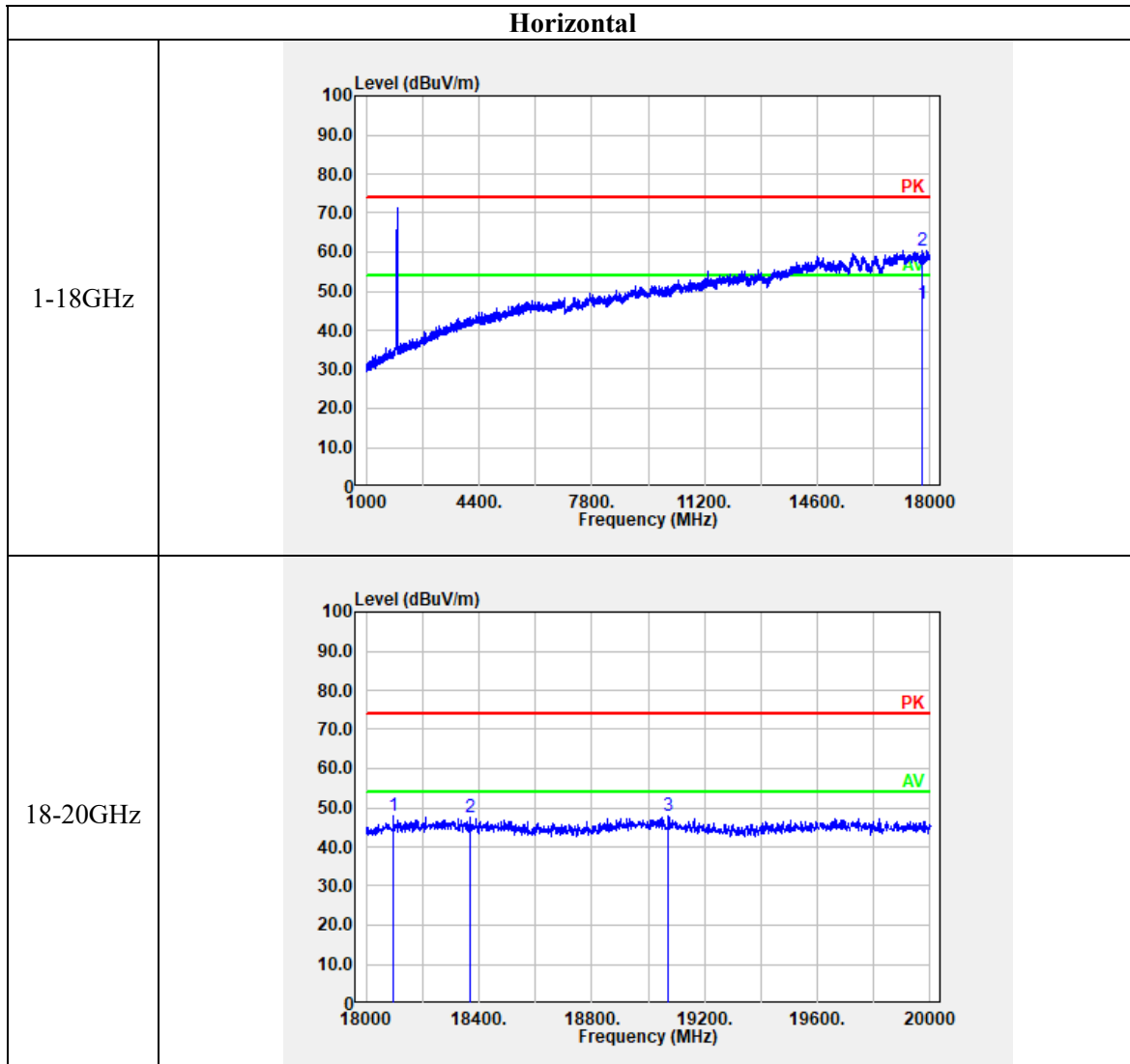

Vertical

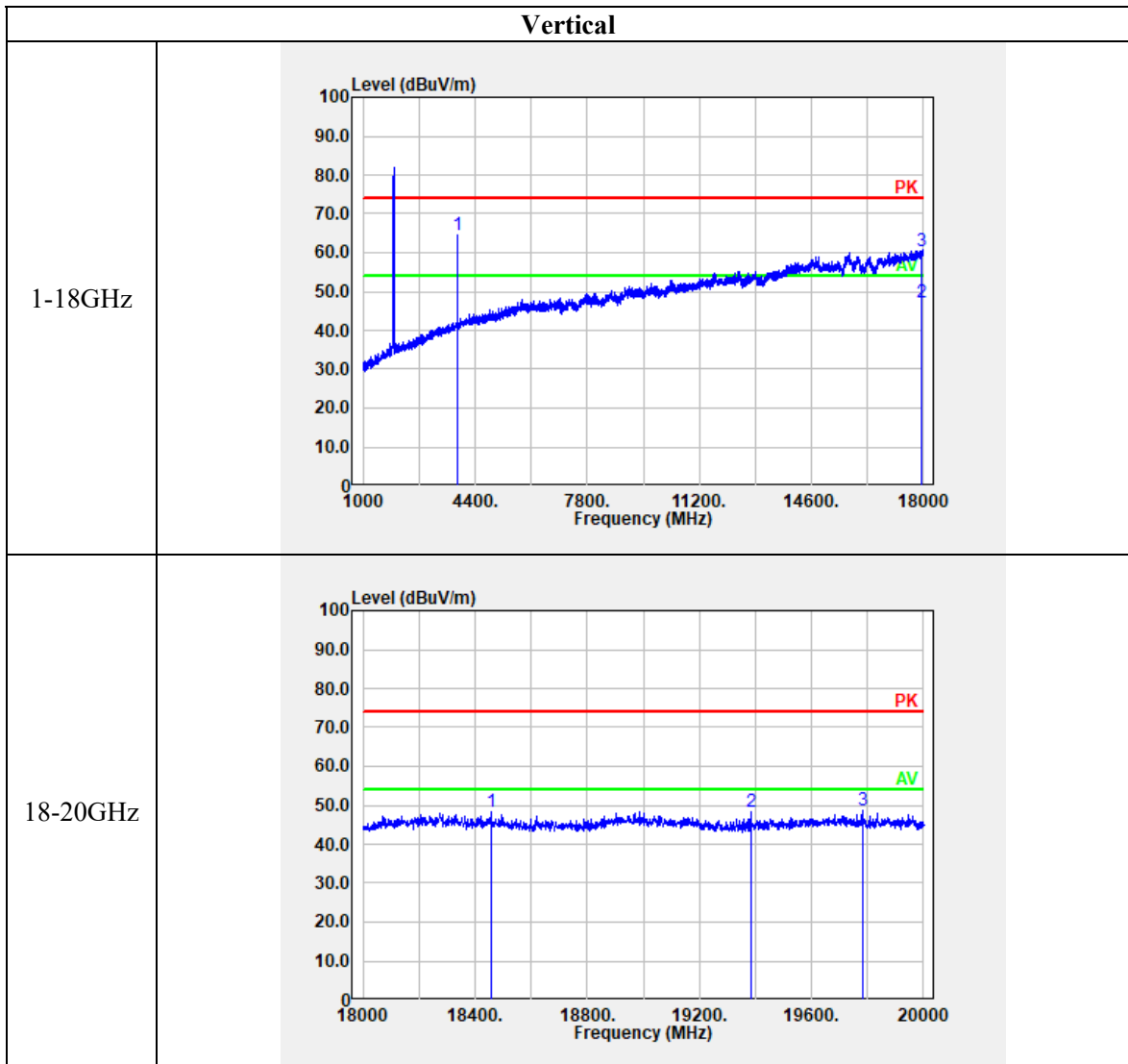

4.7 Frequency Stability:

Serial Number:	22O3_2	Test Date:	2023/3/18
Test Site:	RF	Test Mode:	Transmitting
Tester:	Sugar Xie	Test Result:	NA

Environmental Conditions:

Temperature: (°C)	27.9	Relative Humidity: (%)	55	ATM Pressure: (kPa)	101
----------------------	------	------------------------------	----	------------------------	-----

Test Equipment List and Details:

Manufacturer	Description	Model	Serial Number	Calibration Date	Calibration Due Date
zhuoxiang	Coaxial Cable	SMA-178	211001	Each time	N/A
YINSAIGE	Coaxial Cable	SS402	SJ0100001	Each time	N/A
Mini-Circuits	DC Block	BLK-18-S+	6155/10/22	Each time	N/A
R&S	Digital Radio communication Tester	CMD 60M	846956/010	2022/4/1	2023/3/31
BACL	TEMP&HUMI Test Chamber	BTH-150-40	30174	2022/04/06	2023/04/05
HPA	AC Power Supply	HPA-1110T	HP20200912202	N/A	N/A
UNI-T	Multimeter	UT39A+	C210582554	2022/09/29	2023/09/28

* Statement of Traceability: China Certification ICT Co., Ltd (Dongguan) attests that all calibrations have been performed, traceable to National Primary Standards and International System of Units (SI).

Test Data:

AC Power:

Temperature (°C)	Voltage (V _{AC})	Channel Frequency (MHz)	Measured Frequency Offset (kHz)	Measured Frequency Offset (ppm)	Limit (ppm)
-20	120	1924.992	4	2.08	±10
20	102	1924.992	6	3.12	±10
	138	1924.992	2	1.04	±10
50	120	1924.992	5	2.60	±10

Battery:

Temperature (°C)	Voltage (V _{AC})	Channel Frequency (MHz)	Measured Frequency Offset (kHz)	Measured Frequency Offset (ppm)	Limit (ppm)
-20	2.4	1924.992	4	2.08	±10
20	2.4	1924.992	4	2.08	±10
50	2.4	1924.992	5	2.60	±10

4.8 Specific Requirements for UPCS Device:

Serial Number:	22O3_2	Test Date:	2023/3/18
Test Site:	RF	Test Mode:	Transmitting
Tester:	Sugar Xie	Test Result:	Pass

Environmental Conditions:

Temperature: (°C)	27.9	Relative Humidity: (%)	55	ATM Pressure: (kPa)	101
----------------------	------	---------------------------	----	------------------------	-----

Test Equipment List and Details:

Manufacturer	Description	Model	Serial Number	Calibration Date	Calibration Due Date
R&S	Spectrum Analyzer	FSV40	101474	2022/7/15	2023/7/14
zhuoxiang	Coaxial Cable	SMA-178	211001	Each time	N/A
YINSAIGE	Coaxial Cable	SS402	SJ0100001	Each time	N/A
Mini-Circuits	DC Block	BLK-18-S+	6155/10/22	Each time	N/A
Weinschel	Power Splitter	1515	RA914	Each time	N/A
R&S	Digital Radio communication Tester	CMD 60M	846956/010	2022/4/1	2023/3/31
Agilent	MXG Vector Signal Generator	N5182B	MY51350144	2022/04/22	2023/04/21

* Statement of Traceability: China Certification ICT Co., Ltd (Dongguan) attests that all calibrations have been performed, traceable to National Primary Standards and International System of Units (SI).

Test Data:**1) Automatic Discontinuation of Transmission****Test result:**

The following tests were performed after a connection had been established with baby unit.

Test condition	Reaction of EUT	Pass/Fail
Adapter and battery removed from EUT	Connection break down	Pass
Adapter and battery remove from BU	Connection break down	Pass

2) Monitoring Time

Test result:

This requirement is covered by the results of Least Interfered Channel (LIC).

Interference (Refer to ANSI C63.17 clause 7.3.3)	Reaction of EUT	Results
a) Apply the interference on f_1 at level $T_L+U_M+20\text{dB}$ and no interference on f_2 . Initiate transmission and verify the transmission only on f_2 . Then terminate it.	EUT transmits on f_2	Pass
b) Apply the interference on f_2 at level $T_L+U_M+20\text{dB}$ and immediately remove all interference from f_1 . The EUT should immediately attempt transmission on f_1 (but at least 20 ms after the interference on f_2 is applied), verify the transmission only on f_1 .	EUT transmission f_1	Pass

3) Lower Monitoring Threshold

Test result:

Not applicable because the EUT has more 40 defined duplex system access channels and meet the provision of the Least Interfered Channel (LIC).

4) Maximum Transmit Period

Test result:

Repetition of Access Criteria	Measured Maximum Transmission Time (Second)	Limit (Second)	Results
First	18280	28,800	Pass
Second	18280	28,800	Pass

5) System Acknowledgement

Test result:

Test	Time taken (second)	Limit (second)	Result
Initial Connection acknowledgement	0.38	1	Pass
Change of access criteria for control information	N/A	30	N/A
Transmission cease time after loss of acknowledgement	4.17	30	Pass

Note: N/A=Not Applicable

6) Least Interfered Channel (LIC)

Calculation of monitoring threshold limits for isochroous devices:

Lower threshold: $T_L = -174 + 10 \log_{10} B + M_L + P_{MAX} - P_{EUT}$ (dBm)

Where: B=Emission bandwidth (Hz)

M_L = dB the threshold may exceed thermal noise (30 for T_L)

$P_{MAX} = 5 \log_{10} B - 10$ (dBm)

P_{EUT} = Transmitted power (dBm)

Calculated thresholds:

Monitor Threshold	B(MHz)	M_L (dB)	P_{MAX} (dBm)	P_{EUT} (dBm)	Threshold (dBm)
Lower threshold	1.461	30	20.82	18.20	-79.73

Note: 1. The upper threshold is applicable as the EUT utilizes more than 20 duplex system channels

Test result:

LIC procedure test:

Interference (Refer to ANSI C63.17 clause 7.3.3)	Reaction of EUT	Results
a) Apply the interference on f_1 at level $T_L + U_M + 7$ dB and the interference on f_2 at level $T_L + U_M$. Initiate transmission and verify the transmission only on f_2 . Repeat 5 times.	EUT transmits on f_2	Pass
b) Apply the interference on f_1 at level $T_L + U_M$ and the interference on f_2 at level $T_L + U_M + 7$ dB. Initiate transmission and verify the transmission only on f_1 . Repeat 5 times.	EUT transmits on f_1	Pass
c) Apply the interference on f_1 at level $T_L + U_M + 1$ dB the interference on f_2 at level $T_L + U_M - 6$ dB. Initiate transmission and verify the transmission only on f_2 . Repeat 5 times.	EUT transmits on f_2	Pass
d) Apply the interference on f_1 at level $T_L + U_M - 6$ dB and the interference on f_2 at level $T_L + U_M + 1$ dB. Initiate transmission and verify the transmission only on f_1 . Repeat 5 times.	EUT transmits on f_1	Pass

Selected channel confirmation:

Interference (Refer to ANSI C63.17 clause 7.3.4)	Reaction of EUT	Results
a) Apply the interference on f_1 at level $T_U + U_M$ and no interference on f_2 . Initiate transmission and verify the transmission only on f_2 . Then terminate it.	EUT transmits on f_2	Pass
b) Apply the interference on f_2 at level $T_L + U_M$ and immediately remove all interference from f_1 . The EUT should immediately attempt transmission on f_1 (but at least 20 ms after the interference on f_2 is applied), verify the transmission only on f_1 .	EUT transmission f_1	Pass

7) Random waiting

Note: This is Not Applicable

8) Monitoring Bandwidth and Reaction Time

Test result:

Monitoring Bandwidth:

The antenna of the EUT used for monitoring is the same interior antenna that used for transmission, so the monitoring system bandwidth is equal to the emission bandwidth of the intended transmission

Reaction Time Test:

No.	Interference Pulse width (μs)	Reaction of EUT	Observing time (μs)	Result
1	50μs with level T_L+U_M	No transmission	26.44	Pass
2	35μs with level T_L+U_M+6dB	No transmission	21.18	Pass

9) Monitoring Antenna

Test result:

The antenna of the EUT used for transmission is the same interior antenna that used for monitoring.

10) Monitoring threshold relaxation

Test result:

This requirement is covered by the results of Least Interfered Channel (LIC).

11) Duplex Connections

Test result:

Interference (Refer to ANSI C63.17 § 8.3& § 8.3.2)	Reaction of EUT	Results
a) Only a single carrier f_1 for EUT TDMA systems and on f_1 and f_2 and corresponding duplex carriers for FDMA systems.	EUT can transmit	Pass
b) All Tx windows with level T_L+U_M except one & Rx windows with level T_L+U_M+7dB except one, which are not the duplex mate.	Connected on the target Rx window and its duplex mate.	Pass
c) All Tx windows with level T_L+U_M+7dB except one & Rx windows with level T_L+U_M except one, which are not duplex mate.	Connected on the target Tx window and its duplex mate.	Pass
d) All Tx & Rx windows with level T_U+U_M , except one for Tx window & one for Rx window, which are not duplex mate.	No connection possible	Pass

12) Alternative monitoring interval**Test result:**

Interference (Refer to ANSI C63.17 § 8.4)	Reaction of EUT	Results
a) Only a single carrier f_1 for EUT TDMA systems and on f_1 and f_2 and corresponding duplex carriers for FDMA systems.	EUT can transmit	Pass
b) Apply interference with same parameters as EUT transmissions on all Tx windows with level TL+UM on the enabled carrier(s) and no interference on the Rx windows on the enabled carriers.	No connection is established	Pass

IC:

Not appropriate, as the system always monitor both the transmit and receive time/spectrum windows, it is not a co-located device.

13) Fair Access**Test result:**

The manufacturer declares that this device does not use any mechanisms as provided by FCC §15.323(c)(10) or (11) & IC RSS-213 5.2(10) and (11) to extend the range of spectrum occupied over space or time for the purpose of denying fair access to spectrum to other device.

14) Frame Repetition Stability Frame Period and Jitter**Test result:**

Frame Period and Jitter:

Max. pos. Jitter (μs)	Max. neg. Jitter (μs)	Frame period (ms)	Limit	
			Frame Period (ms)	Jitter (μs)
0.05	-0.06	10.12	20 or 10/X	25

Note: X is a positive whole number.

===== END OF REPORT =====