



motorola

PIP1200
2.8" Video Baby Monitor



For: PIP1200, PIP1200-2, PIP1200-3 and PIP1200-4

User Guide

Welcome...

to your new Motorola Digital Video Baby Monitor!

Thank you for purchasing the video baby monitor. Now you can see and hear your baby sleeping in another room or you can monitor your older children in their playroom.

Please retain your original dated sales receipt for your records. For warranty service of your Motorola product, you will need to provide a copy of your dated sales receipt to confirm warranty status. Registration is not required for warranty coverage.

For product related questions, please contact us by visit at:

motorolanurse.com

This User's Guide provides you with all the information you need to get the most from your product.

Before you can use the baby monitor, we recommend you insert and fully charge the battery in the Parent Unit, so that it continues to work if you disconnect it from the power supply to carry it to another location. Please read the Safety Instructions on pages 7 - 9 before you install the units.

Got everything?

- 1 x Parent Unit
- 1 x Baby Unit (Camera)
- 1 x Rechargeable Li-ion battery pack for the Parent Unit
- 1 x Battery door for Parent Unit
- 2 x Power adapters for the Parent and Baby units

In multi-camera packs, you will find one or more additional baby units with power adapter units.

Overview of the Parent Unit

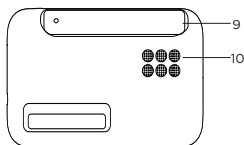
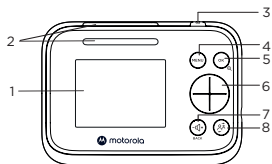

1. Screen display

2. Dual sound level indications
(front and top view)

3. Power button

Press and hold to turn on or off.
Press to turn the screen on or off.

4. Menu button

Press to open the menu.

5. OK / Zoom button

Press to confirm a selection/zoom
in or out.

6. Navigation button

Adjust menu settings/press left
or right to select the parent
unit's volume level.

7. Volume / Back button









8. Talk back button

Press and hold to talk to the baby.













9. Antenna

10. Speaker

Parent Unit menu icons

-  Adjust LCD brightness
-  Set the alarm
-  Temperature unit °C or °F selection and high/low detection
-  Screen on/off timer
-  Play lullaby
-  Add camera
-  Delete camera
-  View multiple cameras (not applicable for single camera)

Parent Unit status icons

-  Signal strength
-  Battery level indication
-  Zoom in
-  Alarm set
-  Playing lullaby
-  Speaker off
-  Talk back
-  Night vision
-  Cycle view from camera
-     Camera selected

Overview of Your Baby Unit

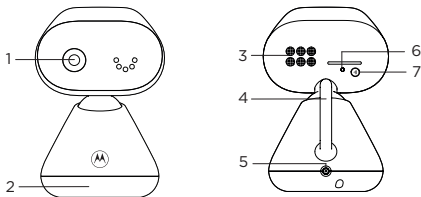

1. Camera

2. Base

3. Speaker

4. Antenna

5. Power jack

6. Power / Linking LED indicator

Lights up in blue when the parent unit is powered on and linked to the baby (camera) unit.

7. Pair button

Press and hold to pair with the parent unit.

Important guidelines for installing your Video Baby Monitor

- To use your Baby Unit and Parent Unit together, you must be able to establish a radio link between them, and the range will be affected by environmental conditions.
- Any large metal object, like a refrigerator, a mirror, a filing cabinet, a metallic door or reinforced concrete, between the Baby Unit and Parent Unit may block the radio signal.
- The signal strength may also be reduced by other solid structures, like walls, or by radio or electrical equipment, such as TVs, computers, cordless or mobile phones, fluorescent lights or dimmer switches.
- Other 2.4GHz products, such as wireless networks (Wi-Fi® routers), Bluetooth™ systems, microwave ovens or other Baby Monitors, may cause interference with this product, so keep the Baby Monitor at least 5ft (1.5m) away from these types of product, or switch them off if they appear to be causing interference.
- If the signal is weak, try moving the Parent and/or the Baby Unit to different positions in the rooms.

Table of contents

1.	Safety Instructions	7
2.	Getting Started.....	10
2.1	Baby Unit Power Supply.....	10
2.2	Parent Unit Battery Installation	11
2.3	Parent Unit Power Supply	12
2.4	Desktop Stand of the Parent Unit	13
3.	Using the Baby Monitor.....	14
3.1	Setting Up.....	14
3.2	Power On or Off the Baby Unit	14
3.3	Power On or Off the Parent Unit	14
3.4	Night Vision Mode	15
3.5	Turn off Parent Unit LCD Screen	15
4.	Parent Unit Menu Options	16
4.1	Adjust Speaker Volume	16
4.2	LCD Brightness	16
4.3	Set Alarm Time on the Parent Unit.....	16
4.4	Monitor the Temperature	17
4.5	Remove a Baby Unit from the Parent Unit.....	18
4.6	Set Screen Off time for the Parent Unit	18
4.7	Zoom, Pan or Tilt	18
4.8	Pair and Replace a Baby Unit	19
4.9	Multi-Camera Use	19
5.	Disposal of the Device (environment)	20
6.	Cleaning	21
7.	Troubleshooting	22
8.	General Information	24
9.	Technical Specifications	29

1. Safety Instructions

WARNING:

STRANGULATION HAZARD - Keep the unit and adaptor cord more than 3 feet from the crib and out of the baby's reach. **NEVER** place Baby Unit or cords within the crib. Secure the cords more than 3 feet away from the baby's reach. Never use extension cords with AC Adaptors. Only use the AC Adaptors provided.

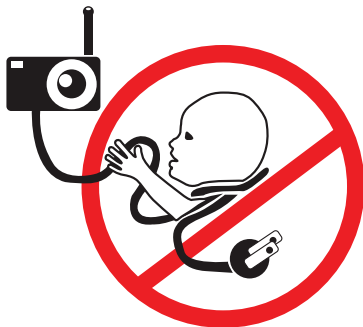

BABY UNIT SET UP & USE:

- Determine a location for the Baby Unit that will provide the best view of your baby in his/her crib.
- Place the Baby Unit on a flat surface, such as a dresser, bureau, or shelf.
- **NEVER** place the Baby Unit or cords within the crib.

WARNING

This Baby Monitor is compliant with all relevant standards regarding electromagnetic fields and is, when handled as described in the User's Guide, safe to use. Therefore, always read the instructions in this User's Guide carefully before using the device.

- Adult assembly is required. Keep small parts away from children when assembling.
- This product is not a toy. Do not allow children to play with it.
- This Baby Monitor is not a substitute for responsible adult supervision.
- Keep this User's Guide for future reference.
- Do not place the Baby Unit or cords in the crib or within reach of the baby (the Unit and cords should be more than 1 meter away).
- Keep the cords out of reach of children.
- Do not cover the Baby Monitor with a towel or blanket.
- Test this monitor and all its functions so that you are familiar with it prior to actual use.
- Do not use the Baby Monitor in damp areas or close to water.
- Only use the chargers and power adapters provided. Do not use other chargers or power adapters as this may damage the device and battery pack.

-
- Only insert a battery pack of the same type.
 - Do not touch the plug contacts with sharp or metal objects.
 - Connect the power adapters to easily accessible electrical outlets.

CAUTION

Risk of explosion if battery is replaced by an incorrect type.

Dispose of used batteries according to their instructions.

Use only the rechargeable battery pack with rating: 3.7V

2000mAh

2. Getting Started

2.1 Connecting the Power Supply for the Baby Unit

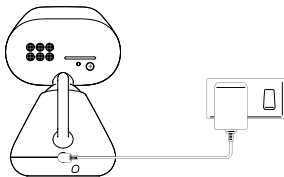

1. Plug the DC plug of the power adapter into the power socket on the rear of the baby (camera) unit and plug the other end of the AC adapter into the wall socket.
2. The baby unit turns on and the power indicator lights up in blue.

WARNING

Strangulation Hazard. Children have STRANGLED in cords. Keep this cord out of the reach of children (more than 1 meter or 3 feet away). Do not remove the tags from the AC Adapters. Only use the AC Adapters provided.

2.2 Connecting the power supply of the Parent Unit

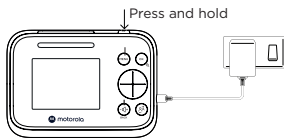

A rechargeable battery is already pre-installed inside the parent unit. When fully charged, you can move the parent unit without losing the link and picture from the baby (camera) unit. When charging the battery for the first time, charge for at least 16 hours continuously.

1. Plug the DC plug of the power adapter into the power socket on the side of the parent unit and plug the other end of the AC adapter into the wall socket.

2. Switch on the AC power and the parent unit will turn on.
3. When the parent unit is fully charged,  will appear steadily on the screen display.
4. Press and hold the power button on the top of the parent unit to turn it on and off.

Note

Use only the supplied power adapter (DC5V / 1000 mA).

Pair the baby (camera) unit to the parent unit

We have paired the baby unit to the parent unit in the pack. In case you want to pair an extra camera, press and hold  on the rear of the baby (camera) unit until the LED blinks.

2.3 Wall mount the baby (camera) unit

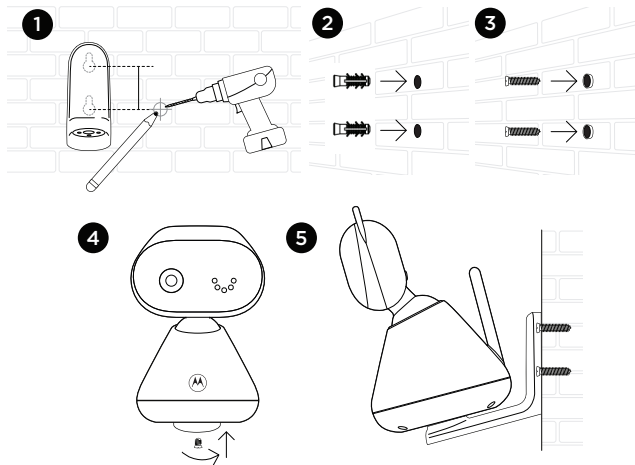

-
1. Mark the positions of 2 screw holes on the wall. Drill a screw hole at each marking.
 2. Install the supplied wall anchors into 2 screw holes on the wall.
 3. Insert the supplied wall mounting screws into the wall anchors.
 4. Fix and fasten the underside of the baby (camera) unit and the wall mount bracket with the supplied separate screw.
 5. Hang the wall mount bracket on the wall mounting screws on the wall.
 6. Adjust the camera manually if necessary.

















Note

The pack includes a power adapter with a longer cord which is beneficial for wall mount application, where your wall socket is far from the camera.

2.4 Registration (Pairing)

The Baby Monitor is pre-registered to your Parent Unit. You do not need to register it again unless the Baby Unit loses its link with the Parent Unit.

To re-register your Baby Unit, or register a new Baby Unit, follow the procedures below:

1. Press the  button and the menu bar will pop up.
2. Press the  LEFT button or  RIGHT button until  is highlighted, and the  del/  add/  view/  scan menu will pop up.
3. Press the  UP button or  DOWN button to select  add, and press the **OK** button to confirm.
4. Camera  ***1** /  **2** /  **3** /  **4** will pop up. Press the  UP button or  DOWN button to select the desired Camera, and press the **OK** button to start searching for a camera unit.

Note: If a camera is currently paired with the Parent Unit, its camera location (with a * against it) cannot be selected for a new registration.

5. Press and hold the **PAIR** button on the underside of the Baby Unit until the Parent Unit finds the camera, beeps and **PAIR OK** appears on the screen. The video from the camera will then appear.

NOTE

A camera can only be registered to one Parent Unit at any one time.

3. Using the Baby Monitor

Please read these instructions carefully, and be aware that this baby monitor is only intended as an aid. It is not a substitute for responsible adult supervision.

3.1 Setting Up

- Make sure that the Baby Unit and Parent Unit are both switched on.
- Place the Baby Unit in a convenient location (e.g. on a table) and point the camera lens towards the area you want to monitor.

NOTE

Do not place the Baby Unit within reach of a child or baby! If there is interference with the picture or sound, try moving the units to different locations, and ensure that they are not close to any other electrical equipment.

If you place the Parent Unit and Baby Unit too close together, you may hear a high pitched noise. This is not a fault. The units are designed to be operated at some distance apart. So move the units further apart.

3.2 Power On or Off the Baby Unit

Slide the ON/OFF switch to the On position to turn on the Baby Unit.

The Power/Link indicator lights up in green.

Slide the Power ON/OFF switch to the Off position to turn off the Baby Unit.

The Power/Link indicator goes off.

3.3 Power On or Off the Parent Unit

Press and hold  to turn on the Parent Unit. The Power/Link indicator lights up in green.

Press and hold  to turn off the Parent Unit. The Power/Link indicator goes off.

NOTE

If you place the Parent and Baby Units too close together, you may hear a high pitched noise. This is not a fault. The units are designed to be operated at some distance apart, e.g. in separate rooms, so move the units further apart.

3.4 Night Vision Mode

The Baby Unit has 6 high-intensity infrared LEDs for picking up clear images in the dark. When the built-in photo sensor on the front of the unit detects a low level of ambient light, the LEDs will automatically activate and the screen on the Parent Unit will display in black and white. The 🌙 icon will be displayed at the top of the screen.

3.5 Turn off Parent Unit LCD Screen

You can turn off the Parent Unit screen without switching off the Parent Unit. When the screen is turned off, you can still hear sound from the Baby Unit.

Press the POWER ON/OFF button  on the Parent Unit to turn off the LCD screen, but still leave the audio monitor on.

Press any key on the Parent Unit to turn on the screen again.

4. Parent Unit Menu Options

4.1 Adjust Speaker Volume

You can adjust the speaker volume from Volume 1 to Volume 5, or turn it off. Press **⏪** or **⏩** on the Parent Unit when it is in camera viewing mode. When the speaker volume is set to off, the screen displays .

4.2 LCD Brightness

You can adjust the brightness of the Parent Unit screen from Level 1 to Level 5.

1. Press **≡** when the Parent Unit is in camera viewing mode to show the menu options with  displayed in red.
2. Press **OK**, then **⏪** or **⏩** to adjust the brightness.
3. Press **OK** to confirm your selection.

4.3 Set Alarm Time on the Parent Unit

You can use the Parent Unit to set the alarm as a reminder for you to take care of your baby.

If an alarm time is selected, the Parent Unit emit multiple beeps repeatedly at the end of the selected 2, 3, 4, 5 or 6 hour period, and the alarm icon will appear in the center of the screen. The alarm can be cancelled by pressing any button, except the Power ON/OFF button , on the Parent Unit.

Turn on and set the alarm when it is currently off:







1. Press **≡** when the Parent Unit is in camera viewing mode.
2. Press **⏪** or **⏩** to scroll to .
3. Press **OK**, then **⏪** or **⏩** to choose On, then press **OK**.
4. Press **⏪** or **⏩** to choose 2h, 3h, 4h, 5h or 6h.
5. Press **OK** to confirm your selection.

Turn off the alarm when it is currently on:

1. Press **≡** when the Parent Unit is in camera viewing mode.
2. Press **⏪** or **⏩** to scroll to .
3. Press **OK**, then **⏪** or **⏩** to choose Off.
4. Press **OK** to confirm your selection.

4.3.1 Set lullaby

You can play calming sounds on the Baby Unit to comfort your baby.









1. Press  when the Parent Unit is in camera viewing mode.
2. Press  or  to scroll to .
3. Press **OK**, then  or  to choose your desired lullaby.
4. Press **OK** to confirm your selection.

4.4 Monitor the Temperature

Your Baby Unit measures the surrounding temperature. If the detected temperature goes outside a selected temperature range, you can set the Parent Unit to emit an alert tone and show a warning message on the screen. You can change the settings for the temperature format, range, and alert as follows:











4.4.1 Temperature Format

You can choose to display the temperature in °F or °C.

1. Press  when the Parent Unit is in camera viewing mode.
2. Press  or  to scroll to .
3. Press **OK**, then  or  to scroll to  and press the **OK** button.
4. Press  or  to choose °F or °C.
5. Press **OK** to confirm your selection.

4.4.2 Temperature Range

You can set the maximum (25 - 39°C/77 - 102°F) and minimum (10 - 24°C/50 - 76°F) values for the temperature, so that when the room temperature goes outside the temperature range, you will receive an alert if the Temperature Alert is set on.

1. Press  when the Parent Unit is in camera viewing mode.
2. Press  or  to scroll to .
3. Press **OK**, then  or  to scroll to  and press the **OK** button.
4. Press  or  to scroll to MAX for the maximum temperature, or MIN for the minimum temperature.
5. Press **OK**, then  or  to select the MAX or MIN temperature and press **OK** to confirm your selection.

4.4.3 Temperature Alert

You can set whether to receive a visual and audible alert when the room temperature goes outside the selected temperature range.

1. Press **≡** when the Parent Unit is in camera viewing mode.
2. Press **◀** or **▶** to scroll to **⏸**.
3. Press **OK**, then **▲** or **▼** to scroll to **⏸** and press the **OK** button.
4. Press **▲** or **▼** to choose On or Off.
5. Press **OK** to confirm your selection.

4.5 Remove a Baby Unit from the Parent Unit

1. Press **≡** when the Parent Unit is in camera viewing mode.
2. Press **◀** or **▶** to scroll to **ⓧ**.
3. Press **OK**, then **▲** or **▼** to select the desired Baby Unit (cam 1, 2, 3 or 4).
4. Press **OK**, then press **◀** or **▶** to choose YES or NO.
5. Press **OK** to confirm your selection.

NOTE

You cannot remove a Baby Unit if it is the only one paired.

4.6 Set Screen Off time for the Parent Unit

You can set the screen off time for the Parent Unit after it is in idle mode for a specific time interval.

1. Press **≡** when the Parent Unit is in camera viewing mode.
2. Press **◀** or **▶** to scroll to **⏻**.
3. Press **OK**, then **▲** or **▼** to select (60mins, 30mins, 5mins or OFF).
4. Press **OK** to confirm your selection.

4.7 Zoom, Pan or Tilt

You can zoom in or out while viewing the image from a Baby Unit.







1. Press **▶** to zoom in.
2. Press and hold **◀**, **▶**, **▲** or **▼** to move the zoomed image left, right, up or down correspondingly.
3. Press **◀** to zoom out.

4.8 Pair and Replace a Baby Unit

The Baby Units and Parent Unit provided are already paired. You can add or replace a Baby Unit in your video and audio monitoring system.

You can pair a maximum of four Baby Units to your Parent Unit. Each new Baby Unit must be paired to the Parent Unit before use.

To pair and replace a Baby Unit:

1. Press  when the Parent Unit is in camera viewing mode.
2. Press  or  to scroll to .
3. Press **OK**, then  or  to choose a desired Baby Unit number, then press **OK**. The pairing mode starts.
4. Turn on the new Baby Unit, and then immediately press and hold **PAIR** until the Power/Link indicator turns on. The unit will beep and the picture from the new camera will appear on the screen.

NOTE

You cannot choose a Baby Unit number that is already occupied, and it must be removed before the new Baby Unit can replace the existing Baby Unit.

4.9 Multi-Camera Use

You can pair up to 4 cameras with the Parent Unit. If more than one camera is paired with the Parent Unit, you can select which camera to view or set it in Patrol mode , where the Parent Unit automatically cycles through the paired cameras about every 10 seconds.

NOTE

The audio from a camera can only be heard on the Parent Unit when that camera is selected.

To change the camera being viewed:

Press **OK** when the Parent Unit is in camera viewing mode to step through the paired cameras, 1, 2, 3, 4, , with the selected option shown on the screen.

6. Help

No display

- Try recharging the battery pack.
- Reset the parent and baby (camera) units. Unplug both the units' from the wall socket, then plug them back in.
- Check if the parent/baby (camera) unit is switched on.
- Press and hold the power button on the parent unit to switch it on.
- Make sure the correct camera is selected. Change the camera number if necessary.
- Make sure the display of the parent unit is turned on.
- When operating using batteries only, the display will go blank after 5 minutes, 15 minutes or 30 minutes to save power (depending on video settings). The parent unit is still active and will give you audio alerts. You can press any button to reactivate the screen.

The baby (camera) unit has lost its link with the parent unit.

- The baby (camera) unit is too far away and may be out of range. Move the it closer to the parent unit.
- Disconnect both the parent and baby (camera) units from the power outlet. Wait for about 15 seconds and reconnect them. Allow up to one minute for the parent and baby (camera) units to synchronize.
- Re-register your baby (camera) unit if necessary, see page 13.

Noise interference on your parent unit

- The baby and parent units may be too close with each other. Move them further apart.
- Make sure there is at least 3 to 6 feet between the parent and baby (camera) units to avoid audio feedback.
- The baby (camera) unit is too far away and may be out of range. Move the it closer to the parent unit.
- Make sure the parent and baby (camera) units are not placed near other electrical equipment, such as a television, computer or cordless/mobile telephone. Move the parent and baby (camera) units 5 feet away from other electrical equipment.
- Use of other 2.4 GHz products, such as wireless networks (Wi-Fi® routers), Bluetooth™ systems, or microwave ovens, may cause interference with this product. Keep the parent and baby (camera) units at least 5 feet away from these types of products, or switch them off if they appear to be causing interference.
- If the signal is weak, try moving the parent and/or baby (camera) units to different positions in rooms.

Noise interference on your device

- To avoid background noise or echoes, ensure there is enough distance between your device and the camera (baby unit).
- Use of other 2.4 GHz products, such as wireless networks (Wi-Fi® routers), Bluetooth™ systems, or microwave ovens, may cause interference with this product. Keep the parent and baby (camera) units at least 5 feet away from these types of products, or switch them off if they appear to be causing interference.

7. General information

Cleaning and care

Important

Always switch off and disconnect the power adaptor before cleaning your video baby monitor.

- Clean your video baby monitor with a slightly damp cloth or with an anti-static cloth. Never use cleaning agents or abrasive solvents.
- Do not clean any part of the video baby monitor with thinners or other solvents and chemicals - this may cause permanent damage to the product which is not covered by the warranty.
- Keep your video baby monitor away from hot, humid areas or strong sunlight, and do not let it get wet.
- Every effort has been made to ensure high standards of reliability of your Digital Audio Baby Monitor. However, if something does go wrong, please do not try to repair it yourself - contact Customer Service for assistance.

Disposal of the Device (environment)

At the end of the product life cycle, you should not dispose of this product with normal household waste. Take this product to a collection point for the recycling of electrical and electronic equipment. The symbol on the product, user guide and/or box indicates this. Some of the product materials can be re-used if you take them to a recycling point. By reusing some parts or raw materials from used products you make an important contribution to the protection of the environment. Please contact your local authorities in case you need more information on the collection points in your area. Dispose of the battery pack in an environmentally-friendly manner according to your local regulations.



Consumer Products and Accessories Warranty

Thank you for purchasing this Motorola branded product manufactured under license by Meizhou Guo Wei Electronics Co. LTD., AD1 section, The economy exploitation area, Meizhou, Guangdong, P.R.China . (“MZGW”)

What Does this Warranty Cover?

Subject to the exclusions contained below, MZGW warrants that this Motorola branded product (“Product”) or certified accessory (“Accessory”) sold for use with this product that it manufactured to be free from defects in materials and workmanship under normal consumer usage for the period outlined below. This Limited Warranty is your exclusive warranty and is not transferable.

Who is covered?

This warranty extends only to the first consumer purchaser, and is not transferable.

What will MZGW do?

MZGW or its authorized distributor at its option and within a commercially reasonable time, will at no charge repair or replace any Products or Accessories that do not conform to this limited warranty. We may use functionally equivalent reconditioned / refurbished / pre-owned or new Products, Accessories or parts.

What Other Limitations Are There?

ANY IMPLIED WARRANTIES, INCLUDING WITHOUT LIMITATION THE IMPLIED WARRANTIES OF MERCHANTABILITY AND FITNESS FOR A PARTICULAR PURPOSE, SHALL BE LIMITED TO THE DURATION OF THIS LIMITED WARRANTY, OTHERWISE THE REPAIR OR REPLACEMENT PROVIDED UNDER THIS EXPRESS LIMITED WARRANTY IS THE EXCLUSIVE REMEDY OF THE CONSUMER, AND IS PROVIDED IN LIEU OF ALL OTHER WARRANTIES, EXPRESS OR IMPLIED. IN NO EVENT SHALL MOTOROLA OR MZGW BE LIABLE, WHETHER IN CONTRACT OR TORT (INCLUDING NEGLIGENCE) FOR DAMAGES IN EXCESS OF THE PURCHASE PRICE OF THE PRODUCT OR ACCESSORY, OR FOR ANY INDIRECT, INCIDENTAL, SPECIAL OR CONSEQUENTIAL DAMAGES OF ANY KIND, OR LOSS OF REVENUE OR PROFITS, LOSS OF BUSINESS, LOSS OF INFORMATION OR OTHER FINANCIAL LOSS ARISING OUT OF OR IN CONNECTION WITH THE ABILITY OR INABILITY TO USE THE PRODUCTS OR ACCESSORIES TO THE FULL EXTENT THESE DAMAGES MAY BE DISCLAIMED BY LAW.

Some jurisdictions do not allow the limitation or exclusion of incidental or consequential damages, or limitation on the length of an implied warranty, so the above limitations or exclusions may not apply to you. This warranty gives you specific legal rights, and you may also have other rights that vary from one jurisdiction to another.

Products Covered	Length of Coverage
Consumer Products	Two (2) years from the date of the products original purchase by the first consumer purchaser of the product.
Consumer Accessories	Ninety (90) days from the date of the accessories original purchase by the first consumer purchaser of the product.
Consumer Products and Accessories that are Repaired or Replaced	The balance of the original warranty or for ninety (90) days from the date returned to the consumer, whichever is longer.

Exclusions

Normal Wear and Tear. Periodic maintenance, repair and replacement of parts due to normal wear and tear are excluded from coverage.

Batteries. Only batteries whose fully charged capacity falls below 80% of their rated capacity and batteries that leak are covered by this limited warranty.

Abuse & Misuse. Defects or damage that result from: (a) improper operation, storage, misuse or abuse, accident or neglect, such as physical damage (cracks, scratches, etc.) to the surface of the product resulting from misuse; (b) contact with liquid, water, rain, extreme humidity or heavy perspiration, sand, dirt or the like, extreme heat, or food; (c) use of the Products or Accessories for commercial purposes or subjecting the Product or Accessory to abnormal usage or conditions; or (d) other acts which are not the fault of Motorola or MZGW are excluded from coverage.

Use of Non-Motorola branded Products and Accessories. Defects or damage that result from the use of Non-Motorola branded or certified Products or Accessories or other peripheral equipment are excluded from coverage.

Unauthorized Service or Modification. Defects or damages resulting from service, testing, adjustment, installation, maintenance, alteration, or modification in any way by someone other than Motorola, MZGW or its authorized service centers, are excluded from coverage.

Altered Products. Products or Accessories with (a) serial numbers or date tags that have been removed, altered or obliterated; (b) broken seals or that show evidence of tampering; (c) mismatched board serial numbers; or (d) nonconforming or non-Motorola branded housings, or parts, are excluded from coverage.

Communication Services. Defects, damages, or the failure of Products or Accessories due to any communication service or signal you may subscribe to or use with the Products or Accessories is excluded from coverage.

How to Obtain Warranty Service or Other Information?

To obtain service or information, please visit us at:
motorolanursery.com/support

You will receive instructions on how to ship the Products or Accessories at your expense and risk, to a MZGW Authorized Repair Center.

To obtain service, you must include: (a) the Product or Accessory; (b) the original proof of purchase (receipt) which includes the date, place and seller of the Product; (c) if a warranty card was included in your box, a completed warranty card showing the serial number of the Product; (d) a written description of the problem; and, most importantly; (e) your address and telephone number.

FCC and IC regulations

FCC Caution:

Any changes or modifications not expressly approved by the party responsible for compliance could void the user's authority to operate the equipment.

This device complies with part 15 of the FCC Rules. Operation is subject to the following two conditions: (1) This device may not cause harmful interference, and (2) this device must accept any interference received, including interference that may cause undesired operation.

IMPORTANT NOTE:

Note: This equipment has been tested and found to comply with the limits for a Class B digital device, pursuant to part 15 of the FCC Rules. These limits are designed to provide reasonable protection against harmful interference in a residential installation. This equipment generates, uses and can radiate radio frequency energy and, if not installed and used in accordance with the instructions, may cause harmful interference to radio communications. However, there is no guarantee that interference will not occur in a particular installation. If this equipment does cause harmful interference to radio or television reception, which can be determined by turning the equipment off and on, the user is encouraged to try to correct the interference by one or more of the following measures:

- Reorient or relocate the receiving antenna.
- Increase the separation between the equipment and receiver.
- Connect the equipment into an outlet on a circuit different from that to which the receiver is connected.
- Consult the dealer or an experienced radio/TV technician for help.

ISED Warning

This device complies with Innovation, Science, and Economic Development Canada licence-exempt RSS standard(s). Operation is subject to the following two conditions:

- (1) this device may not cause interference, and
- (2) this device must accept any interference, including interference that may cause undesired operation of the device.

Le présent appareil est conforme aux CNR d'Innovation, Sciences et Développement économique Canada applicables aux appareils radio exempts de licence. L'exploitation est autorisée aux deux conditions suivantes :

- (1) l'appareil n'a pas à produire de brouillage, et
- (2) l'utilisateur de l'appareil doit accepter tout brouillage radioélectrique subi, même si le brouillage est susceptible d'en compromettre le fonctionnement.

Radiation Exposure Statement:

The baby unit complies with FCC/ISED radiation exposure limits set forth for an uncontrolled environment. The baby unit should be installed and operated with minimum distance 20cm between the radiator& your body.

The parent unit has been tested and comply with FCC and ISED SAR limits.

Déclaration d'exposition aux radiations:

L'unité bébé est conforme aux limites d'exposition aux rayonnements FCC / ISED établies pour un environnement non contrôlé. L'unité bébé doit être installée et utilisée avec une distance minimale de 20 cm entre le radiateur et votre corps.

L'unité parent a été testée et est conforme aux limites SAR FCC et ISED.

8. Technical Specifications

RF frequency bands	2405 MHz to 2475MHz
Parent unit display	2.8" diagonal TFT LCD
Temperature Operating range	0°C - 40°C or 32°F - 104°F
Baby unit image sensor	Color CMOS 0.3M Pixels
Power adaptor for the baby unit and the parent unit	Input: 100-240V AC, 50/60Hz, 200mA or 300mA; Output: 5.0V DC, 1000mA
Parent unit battery information	Lenovo Corporation (BL253) 3.8V, 2000mAh Lithium-Ion Polymer, rechargeable battery pack
Battery life	7 hours (maximum)

WARNING

Use only with provided power adaptor:

Dongguan Becky Electronics Tech Co., Ltd. (BQ05A-0501000-U)

Input 100-240V AC, 50/60Hz, 300mA;

Output: 5.0V DC, 1000mA

or

Dongguan Everest Industrial Co., Ltd. (EP04-050100WXLZ)

Input : 100-240V AC, 50/60Hz, 200mA;

Output : 5.0V DC, 1000mA

or

ShenZhen Baijunda Electronic Co., Ltd. (AT-538A-050100A)

Input : 100-240V AC, 50/60Hz, 200mA;

Output : 5.0V DC, 1000mA

WARNING

Do not attempt to replace the battery, but contact customer service if it needs replacing.

Note

Specifications are subject to change without prior notice.

EU Declaration of Conformity (DoC)

Hereby, Meizhou Guo Wei Electronics Co. LTD declares that the product is in compliance with RE Directive 2014/53/EU. The full text of the EU declaration of conformity is available on the website: motorolanursery.com

Manufactured, distributed or sold by Meizhou Guo Wei Electronics Co. LTD., official licensee for this product. MOTOROLA and the Stylized M Logo are trademarks or registered trademarks of Motorola Trademark Holdings, LLC. and are used under license. All other trademarks are the property of their respective owners. © 2021 Motorola Mobility LLC.
All rights reserved.

Version 4 (EN-EU&US)

