



# motorola

T6 DIGITAL CORDLESS TELEPHONE  
WITH ANSWERING MACHINE



## **For: T611, T612, T613 and T614**

Handset: Motorola T6-HS

Base: Motorola T61-B

Charger: Motorola T6-C

Warning: Charge the handset for 16 hours before use.

# Safety information

## Important

This equipment is not designed to make emergency telephone calls when the power fails. Alternative arrangements should be made for access to emergency services.

This product is intended for connection to analogue public switched telephone networks and private switchboards in the US.

## Important

To reduce the risk of fire, use only the supplied AC power adaptor.

The applied nameplate is located at the bottom of the unit.

## Important safety instructions

Follow these safety precautions when using your phone to reduce the risk of fire, electric shock, and injury to persons or property:

- Keep all slits and openings of the phone unblocked. Do not set the phone on a heating register or over a radiator. Ensure that proper ventilation is provided at the installation site.
- Do not use while wet or while standing in water.
- Do not use this product near water (for example, near a bath tub, kitchen sink, or swimming pool).
- Do not allow anything to rest on the power cord. Place the power cord so that it will not be walked on.
- Never insert objects of any kind into the product vents as that may result in fire or electric shock.
- Unplug this product from the wall outlet before cleaning. Do not use liquid cleaners or aerosol cleaners. Use a damp cloth for cleaning.
- Do not disassemble this product. If service or repair work is required, contact the customer service helpline found in this user's Guide.
- Do not overload wall outlets and extension cords.
- Avoid using during an electrical storm. There may be a remote risk of electric shock from lightning. Use a surge protector to protect the equipment.
- Do not use this phone to report a gas leak, especially if you are in the vicinity of the gas line.
- For pluggable equipment, the socket-outlet (power adaptor) shall be installed near the equipment and shall be easily accessible.

## Save these instructions

### Unplug this cordless phone immediately from an outlet if:

- The power cord or plug is damaged or frayed.
- Liquid has been spilled on the product.
- The product has been exposed to rain or water. Do not retrieve the handset

or base until after you have unplugged the power and phone from the wall. Then retrieve the unit by the unplugged cords.

- The product has been dropped or the cabinet has been damaged.
- The product exhibits a distinct change in performance.

## **Installation Guidelines**

- Read and understand all instructions and save them for future reference.
- Follow all warnings and instructions marked on the product.
- Do not install this product near a bath tub, sink, or shower.
- Operate this phone using only the power source that is indicated on the marking label. If you are unsure of the power supply to your home, consult with your dealer or local power company.
- Do not place this product on an unstable cart, stand, or table. This product may fall, causing serious damage to the product.
- Adjust only those controls that are covered by the operating instructions. Improper adjustment of other controls may result in damage and will often require extensive work to restore the product to normal operation.
- Clean this product with a soft, damp cloth. Do not use chemicals or cleaning agents to clean this phone.
- Use only the power supply that came with this unit. Using other power supplies may damage the unit.
- Because this phone operates on electricity, you should have at least one phone in your home that could operate without electricity in the case the power in your home goes out.
- To avoid interference to nearby appliances, do not place the base of the phone on or near a TV, microwave oven, or VCR.

## **Battery Safety Instructions**

- Do not burn, disassemble, mutilate, or puncture the battery. The battery contains toxic materials that could be released, resulting in injury.

### **Important**

Warning! Use only the approved rechargeable Ni-MH battery cells (2 x 1.2VDC AAA size 300mAh Ni-MH rechargeable batteries) supplied with your T611, T612, T613 or T614.

### **Caution**

There is a risk of explosion if you replace the battery with an incorrect battery type. Use only the batteries that came with your phone or an authorized replacement recommended by the manufacturer.

- Keep batteries out of the reach of children.
- Remove batteries if storing over 30 days.
- Do not dispose of batteries in fire, which could result in explosion.
- The rechargeable batteries that power this product must be disposed of properly and may need to be recycled. Refer to your battery's label for battery type. Contact your local recycling center for proper disposal methods.

# Welcome...

## to your new Motorola T6 Digital Cordless Telephone with Answering Machine!

- Block anonymous calls or block 100 numbers added to the block call list.<sup>1</sup>
- Answer machine with up to 12 minutes digital recording time.
- All handsets fully cordless for locating anywhere within range.
- 100 name and number phonebook.
- Bright backlit display.
- Speakerphone for hands-free conversations.
- Caller ID shows you who's calling and see details of the last 50 callers in a Calls list.<sup>1</sup>
- Redial up to 10 of the last numbers called.
- Register up to 4 handsets to a single base.
- Make internal calls, transfer external calls, hold 3-way conversations between two internal callers and an external caller.

### Need help?

If you have any problems setting up or using your T6, please contact Customer Services on 1-833-468-1468.

Alternatively, you may find the answer in the 'Help' section at the back of this guide.

<sup>1</sup>You must subscribe to your network provider's Caller ID service for this feature to work. A subscription fee may be payable.

Please Note that this equipment is not designed for making emergency telephone calls when the power fails. Alternative arrangements should be made for access to emergency services.

**This User Guide provides you with all the information you need to get the most from your phone.**

**Before you make your first call you will need to set up your phone. Follow the simple instructions in ‘Getting started’, on the next few pages.**

**Important**

Only use the telephone line cord supplied.

**Got everything?**

- Cordless handset
- Base
- AC power adaptor for the base
- Telephone line cord
- 2 x rechargeable Ni-MH battery cells

**If you have purchased an T6 multiple pack you will also have the following additional items:**

- Cordless handset & charger cradle
- AC power adaptor for the charger cradle
- 2 x rechargeable Ni-MH battery cells

1.	Getting started .....	8
2.	Getting to know your phone .....	12
3.	Using the phone .....	17
3.1	Switch the handset on / off .....	17
3.2	Calls .....	17
3.2.1	Make a call .....	17
3.2.2	Preparatory dialling .....	17
3.2.3	End a call .....	17
3.2.4	Receive a call .....	17
3.3	Adjust the earpiece / hands-free volume .....	17
3.4	Mute .....	17
3.5	Intercom .....	18
3.5.1	Make an internal call .....	18
3.5.2	Receive an internal call .....	18
3.5.3	Transfer a call .....	18
3.5.4	3-way conference call .....	18
3.6	Hands-free .....	19
3.6.1	Make a hands-free call .....	19
3.6.2	Answer a call hands-free .....	19
3.7	Redial .....	19
3.7.1	View or dial an entry .....	19
3.7.2	Copy a Redial list number to the phonebook .....	19
3.7.3	Delete an entry .....	19
3.7.4	Delete the entire Redial list .....	20
3.8	Lock / unlock the keypad .....	20
3.9	Paging / Find handset .....	20
4.	Phonebook .....	21
4.1	Store a name and number .....	21
4.2	View or dial an entry .....	21
4.3	Edit a name and number .....	22
4.4	Delete an entry .....	22
4.5	Delete all entries .....	22
4.6	Store a quickdial number .....	22
5.	Call block .....	23
5.1	Switch anonymous call on/off .....	23
5.2	Switch block mode on/off .....	23
5.3	Set a call block number .....	23
6.	Clock and alarm .....	24
6.1	Date & time .....	24
6.2	Setting the alarm .....	24
7.	Phone setup .....	25
7.1	Handset tones .....	25
7.1.1	Ring volume .....	25
7.1.2	Ring tones .....	25
7.1.3	Key tones on/off .....	25
7.1.4	Docking tone on /off .....	25

7.1.5	Battery tones .....	26
7.2	Base tones .....	26
7.2.1	Ringer volume .....	26
7.2.2	Ringer melody .....	26
7.3	Handset name .....	26
7.4	Language .....	27
7.5	Auto answer .....	27
7.6	Auto hang-up .....	27
<b>8.</b>	<b>Advanced settings .....</b>	<b>28</b>
8.1	Call list type .....	28
8.2	Area code .....	28
8.3	Auto prefix .....	28
8.4	Flash time .....	28
8.5	Dial mode .....	29
8.6	Switch Auto clock on / off .....	29
8.7	Registration .....	29
8.7.1	Register a handset .....	29
8.7.2	Deregister a handset .....	29
8.8	Restore default settings .....	30
8.9	Default settings .....	30
<b>9.</b>	<b>Caller ID and the Calls list .....</b>	<b>31</b>
9.1	Caller ID .....	31
9.2	Calls list .....	31
9.2.1	View the Calls list .....	31
9.2.2	Dial a number in the Calls list .....	32
9.2.3	Store a Calls list number to the phonebook .....	32
9.2.4	Delete an entry .....	32
9.2.5	Delete the entire Calls list .....	32
9.2.6	Store a number to the blacklist .....	32
<b>10.</b>	<b>Using your Answering Machine .....</b>	<b>33</b>
10.1	Switch the answering machine on / off .....	33
10.2	Listening to your messages .....	33
10.3	Delete all messages .....	34
10.4	Announcement .....	34
10.4.1	Record also .....	34
10.4.2	Answer only .....	34
10.4.3	Record, play or delete your own announcement .....	34
10.4.4	Select the announcement .....	34
10.5	Ring delay .....	35
10.6	Remote access .....	35
10.7	Remote access on/off and change remote PIN .....	36
10.8	Voice language .....	36
10.9	Memory full .....	36
<b>11.</b>	<b>Help .....</b>	<b>37</b>
<b>12.</b>	<b>Technical Specifications .....</b>	<b>39</b>
<b>13.</b>	<b>General information .....</b>	<b>40</b>

# 1. Getting started

## Location

### Important

Do not place your T6 in the bathroom or other humid areas.

Place your T6 base within reach of the AC power outlet and telephone wall jack. The socket-outlet should be installed near the equipment and should be easily accessible.

Make sure it is at least 1 meter away from other electrical appliances to avoid interference. Your T6 works by sending radio signals between the handset and base. The strength of the signal depends on where you place the base. Putting it as high as possible ensures the best signal.

## Handset range

The unit has a range of up to 300 meters outdoors when there is a clear line of sight between the base and handset. Any obstruction between the base and handset will reduce the range significantly. With the base indoors and the handset either indoors or outdoors, the range will normally be up to 50 meters. Thick concrete and stone walls can severely affect the range.

## Signal strength

▬ on your handset indicates that you are within range of the base. When out of range of the base, ▬ disappears. If you are on a call, you will hear a warning beep.

If you are on a call, the line will hang up if the handset moves out of range of the base. Move back within range. The handset will automatically re-connect to the base.

## Setting up

### Important

The base station must be plugged into the AC power at all times. Use only the AC power adaptor and telephone line cord supplied with the product.



## Connecting the base

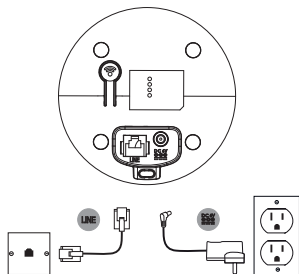

1. Plug the telephone line cord into the socket marked **LINE** on the underside of the base and the other end of the line cord into the telephone line wall jack.
2. Plug the AC power jack into the socket marked **DC 5V** on the underside of the base and plug the AC adaptor into the AC power outlet. Switch on the AC power.

## Installing and charging the handset

1. Remove the battery cover from the back of the handset and insert the rechargeable Ni-MH battery cells supplied. Please note the '+' and '-' markings inside the battery compartment and insert in the correct direction.

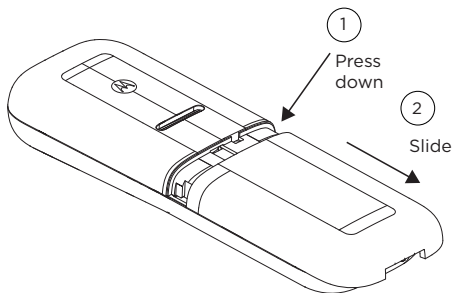



2. Slide the battery cover back into place.
3. When charging the battery pack for the first time, place the handset on the base to charge for at least 16 hours continuously.
4. When the handset is fully charged,  will appear steadily on the display. Plug the other end of the telephone line cord (make sure that one end is already plugged into the base) into the telephone wall socket.

## Connecting the handset and charger cradle (for multi-pack only)

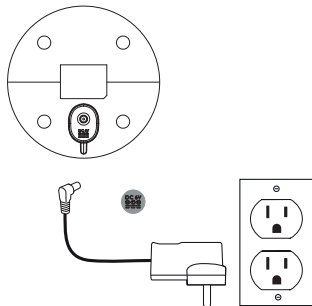
If you have purchased a multiple pack, you will need to carry out this process for all the handsets and charger cradles.



1. Plug the AC power jack into the socket marked  on the underside of the charger cradle and plug the power adaptor into the AC power outlet.
2. Remove the battery cover from the back of the handset and insert the 2 x AAA Ni-MH rechargeable batteries supplied. Please note the '+' and '-' markings inside the battery compartment and insert in the correct direction.
3. Slide the battery cover back into place.
4. When charging the battery pack for the first time, place the handset on the charger cradle to charge for at least 16 hours continuously.
5. When the handset is fully charged,  will appear steadily on the display. The display will show the time and the date on the screen, to indicate that it is registered to the base.

### Important

Warning! Use only the approved rechargeable Ni-MH battery cells (2 x AAA Ni-MH 300mAh rechargeable batteries) supplied with your T6.

### Battery low warning

If  flashes on the display and there is a warning beep every 2 minutes during a call, recharge the handset before using it again.

When charging,  will scroll on the display.

## Battery performance

In ideal conditions, fully charged batteries should give up to 10 hours talk time or up to 200 hours standby time on a single charge.<sup>1</sup>

Note that new batteries do not reach their full capacity until they have been put to normal use for several days.

To keep your batteries in the best condition, leave the handset off the base for a few hours at a time.

Running the batteries right down at least once a week will help them last as long as possible.

The charge capacity of the rechargeable battery will reduce with time as it wears out, giving the handset less talk / standby time. Eventually it will need to be replaced.

After charging your handset for the first time, subsequent charging time is about 6–8 hours a day. Batteries and the handset may become warm during charging. This is normal.

## Important









When fully charged batteries are removed and re-inserted, or the handset is powered off and on, the battery icon on the display will reduce to 1 bar. The battery is still fully charged and the handset can be used as normal. If you charge the handset again by replacing it on the base unit, it will usually show fully charged after 10 minutes (this time will be dependent on the battery capacity). This is normal behaviour and is a reminder to charge the handset to prevent calls being dropped.

<sup>1</sup>All talk and standby times are approximate and depend on features selected and usage pattern.

## Date and time

If you have subscribed to a Caller ID Service and Auto Clock is set to on (see page 29), the date and time is set automatically for all handsets when you receive your first call. If Auto Clock is set to off the time and date does not set automatically.

If you do not have a Caller ID service, you can set the date and time manually.

1. Press , scroll  to **Clock/Alarm** and press .
2. **Date & time** is displayed. Press .
3. Enter the date using the format MM-DD-YY e.g. 08/27/21 for 27 August 2021 and press .
4. Enter the time (HH:MM) e.g. 04.30 and press  or  to select **AM** or **PM** press .
5. Press  to return to standby.

**Your T6 is now ready for use.**

## 2. Getting to know your phone

### Overview of your handset

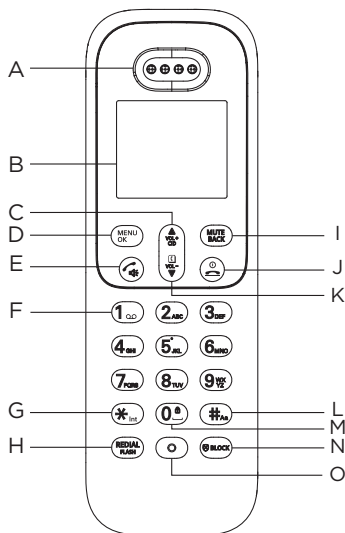

**A Earpiece**

**B Display**

See page 14 for an overview of the display icons.

**C Call List / Scroll Up / Volume up**

Press to enter the Call list.

Scroll up through lists and settings.

Increase the earpiece or hands-free volume during a call.

**D Menu / OK**

Enter the main menu.

Select the option displayed on screen.

Confirm menu option.

**E Talk / Hands-free**

Press to switch hands-free on or off during a call.

Press to make and receive calls.

**F Voicemail**

Press and hold to dial voicemail.

Note: You will need to set the voicemail number if default is empty.

**G \* / Intercom**

Dial a \*.

Press and hold to make an internal call. to make internal calls to other T6 handsets registered to the base.

**H Redial / Flash**

Open the redial list.

Use flash (F) functions.

**I Clear / Mute / Back**

Delete characters and digits when entering names and numbers.

Mute / unmute the microphone during a call.

Go back to previous menu level.

**J End Call / Exit / Switch Handset on / off**

End a call.

When in a menu, go back to standby mode.

Press and hold to switch handset off (when in standby) or on.

**K Phonebook / Scroll Down / Volume down**

Press  to open the phonebook list.

Scroll down through lists and menus.

Decrease the earpiece or hands-free volume during a call.

**L # / Change case / Pause / CID format**

Dial a #.

When entering letters / editing, press and hold to change the case from Abc to abc or ABC mode.

When dialling or storing a number, press and hold to enter a pause (P).

In calls lists: Press to toggle the Caller ID display format among 7, 10 and 11 digits when returning calls from Caller ID list.

**M Keypad lock / Space**

In standby mode press and hold to lock / unlock the keypad.

Press to inset a space in text / number editing.

**N Call block**







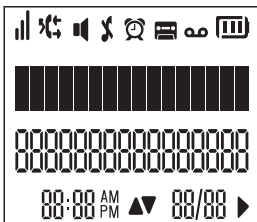









Press to enter the call block menu.

**O Microphone**

## Handset display



## Display icons

-  Indicates signal strength.  
Flashes when handset is not registered to the base or if you go out of range.
-  Flashes to indicate a missed call.
-  Steady when making an outgoing call.  
Flashes to indicate an incoming or internal call.
-  Indicates an incoming call when viewing the calls list.<sup>1</sup>
-  Indicates an outgoing call when viewing the redial list.
-  Hands-free is on.
-  Handset ringer is off.
-  Alarm is on.
-  Answer machine is on.
-  Indicates new voicemail messages received.<sup>2</sup>  
Off when there is no voicemail messages.
-  Time.
-  Date.
-  ▲▼ Indicates you can scroll through a list or adjust the volume in talk mode.
-  Battery is fully charged.
-  Battery is partially charged.
-  Battery is running low.

 Flashes when battery is almost fully discharged.

► Indicates more text after the displayed information.

<sup>1</sup>For this feature to work, you must subscribe to Caller ID Service from your network operator. A subscription fee may be payable.

<sup>2</sup>This feature is dependent on your Network Service provider supporting the service. A subscription fee may be payable.

## Overview of the base

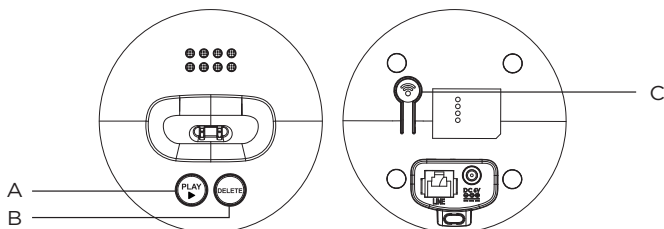

### A Play / New message indicator / Stop

Press to play recorded messages.  
Flashes when there is a new message.  
Stops message playback.

### B Delete

Press to delete recorded messages during playback.  
In standby, press and hold to delete all old messages.

### C Page

In standby mode, press to ring the handset(s).  
Press and hold to enter registration mode when registering handsets.

## Navigating the menus

The basic steps of navigating through the menu and on-screen options.

1. From the standby screen, press **MENU OK** to open the main menu
2. Use **▲ VOL+** to scroll up **▼ VOL-** to scroll down through the menu.
3. Press **MENU OK** to select **OK** and open a sub-menu or validate an option.  
To return to the previous menu level, correct a character or cancel an action, press **MUTE BACK**.
4. Press **0** to return to standby.

### Note

If you do not press any button on the handset for 30 seconds the display will automatically return to standby. It will also return to standby when the handset is placed on the base or charger cradle.

## Menu map

### Phonebook

- View
- Add new
- Edit
- Delete<sup>1</sup>
- Delete all<sup>1</sup>

### Call block

- Anonymous call
- Blacklist

### Clock/Alarm

- Date & time
- Set alarm

### Personal set

- Handset tone
  - Ring volume
  - Ring tones
  - Key tone
  - Docking tone
  - Battery tone
- Base tone
  - Base volume
  - Base melody
- Phone name
- Language
- Auto answer
- Auto hang-up

### Advanced set

- Call list type
- Area code
- Auto prefix
  - Detect digits
  - Prefix
- Flash time
- Dial mode
- Auto clock
- Register
- Unregister
- Reset

### Answ. machine



- Play
- Delete all
- Announcement
- Voice answer
- Ring delay
- Remote access
- Voice language

<sup>1</sup>Only available when a phonebook entry is already stored.



## 3. Using the phone

### 3.1 Switch the handset on / off



1. Press and hold  to switch the handset off.
2. Press  to switch the handset on.

### 3.2 Calls

#### 3.2.1 Make a call

1. Press .
2. Dial the number.

#### 3.2.2 Preparatory dialling

1. Dial the number first. If you make a mistake press  to delete the last digit.
2. Press  to dial.

#### 3.2.3 End a call

1. Press , or place the handset back on the base or charger cradle.

#### Note

If Auto hang up is switched off you will need to press  to end a call.

#### 3.2.4 Receive a call



When you receive an external call, the phone rings and  flashes on the display.

1. Press  to answer the call.

#### Note



If Auto answer is switched on you can simply lift the handset from the base or charger base to answer a call.

### 3.3 Adjust the earpiece / hands-free volume

During a call, press  or  to increase or decrease the volume. There are 5 levels to choose from.

### 3.4 Mute



You can mute your handset so that you can talk to someone nearby without your caller hearing.

1. During a call, press . The display shows **Mute on** and your caller cannot hear you.
2. Press  again to resume your call.

## 3.5 Intercom

### 3.5.1 Make an internal call

If more than one handset is registered to the base, internal calls can be made between two handsets.  flashes and the display shows the handset number you are calling.

1. If only 2 handsets are registered to the base, press and hold  $\star_{\text{Int}}$  and the other handset rings automatically.
2. If more than 2 handset are registered to the base press and hold  $\star_{\text{Int}}$  and scroll  to the handset that is to be called and press .

### 3.5.2 Receive an internal call



When you receive an internal call,  flashes and the handset number that is calling you is displayed.

1. Press  to answer the call.

### 3.5.3 Transfer a call

You can transfer an external call to another handset registered to the base.

#### During an external call:

1. If only 2 handsets are registered to the base, press and hold  $\star_{\text{Int}}$  and the other handset rings automatically.
2. If more than 2 handset are registered to the base press and hold  $\star_{\text{Int}}$  and scroll  to the handset that is to be called and press .
3. When the other handset answers, press  to complete the transfer.





#### Note

Your external call resumes automatically after 1 minute if there is no answer.

### 3.5.4 3-way conference call

You can hold a 3-way conference call between 2 internal callers and 1 external caller.



#### During a call with an external caller:

1. If only 2 handsets are registered to the base, press and hold  $\star_{\text{Int}}$  and the other handset rings automatically.
2. If more than 2 handset are registered to the base press and hold  $\star_{\text{Int}}$  and scroll  to the handset that is to join the call and press .
3. When the other handset answers, press  to connect all three callers to begin the conference call.
4. Press  to end the call.

## 3.6 Hands-free

To talk to the caller without holding the handset and for other people in the room to listen to the conversation over the loudspeaker simply use the hands-free function.



### 3.6.1 Make a hands-free call

1. Dial the number and then press .
2. Press  to end the call.

### 3.6.2 Answer a call hands-free

Press  to answer the call in hands-free.





#### Note

Press  to switch the call between the earpiece and the loudspeaker. During a hands-free call, press  or  to adjust the volume.







## 3.7 Redial

The last 10 entries dialled are stored in the redial list.









### 3.7.1 View or dial an entry

1. Press  to open the Redial list.
2. Scroll  or  to the entry you want.
3. Press  to dial the displayed entry or press  to return to standby.







### 3.7.2 Copy a Redial list number to the phonebook

1. Press  to open the Redial list.
2. Scroll  or  to the entry you want.
3. Press . The display shows **Save number**.
4. Press  again. The display shows **Enter name**.
5. Enter the name and press . The number is displayed.
6. Edit the number if necessary, then press  to save.

### 3.7.3 Delete an entry

1. Press  to open the Redial list.
2. Scroll  or  to the entry you want. Press .
3. If the entry is stored to the phonebook **Delete** is displayed, if not scroll  to **Delete** and press . The display shows **Confirm?**
4. Press  to confirm or  to cancel.

### 3.7.4 Delete the entire Redial list



1. Press  to open the Redial list.
2. Press . Scroll  to **Delete all**.
3. Press  again. The display shows **Confirm?**
4. Press  to confirm or  to cancel.

### 3.8 Lock / unlock the keypad

You can lock the keypad so that it cannot be operated accidentally while carrying it around.



#### Note

When the keypad is locked, you can still answer incoming calls and operate the handset as normal during the call. When the call ends, the keypad lock comes on again.

1. Press and hold .  
**Keys locked** is displayed.
2. To unlock the keypad, press and hold  again.

### 3.9 Paging / Find handset

You can alert a handset user that they are wanted or locate a missing handset. Paging calls cannot be answered by a handset.

1. Press  on the base. All handsets registered to the base will ring.
2. To stop the ringing, press  on the base again or press any button on the handset.

## 4. Phonebook

You can store up to 100 names and numbers in the phonebook. Names can be up to 15 characters long and numbers up to 24 digits.







### 4.1 Store a name and number

If the phone is connected to a switchboard, you may need to enter a pause in a stored number. This gives the switchboard time to find an outside line. A pause is normally stored after the switchboard access code (e.g. 9).

When storing a number, press and hold  until the display shows P. You can then continue storing the phone number.

If you have subscribed to Caller ID Service and wish to display the name of your caller as well as the number, save the full telephone number including the area code to your phonebook.

You can store multiple entries with the same name. However, to prevent unnecessary duplicated entries, you can only store the same number once.

1. Press . The display shows **Phonebook**.
2. Press . Scroll  to **Add new**.
3. Press . The display shows **Enter name**.
4. Enter the name and press . The display shows **Enter number**.
5. Enter the number and press  to save.

#### Entering names

Use the keypad letters to enter names, e.g. to store Tom:

Press **8** once to enter T.

Press **6** three times to enter o.

Press **6** once to enter m.







#### Writing tips

Press  to delete the last character or digit.



Press  or  to move between characters.

Press **0** to insert a space.



### 4.2 View or dial an entry

1. Press .  
Scroll  or  to the entry you want.  
OR  
Enter the first letter of the name to search alphabetically.  
The first name that starts with this letter or the nearest letter in the alphabet will be displayed. Scroll  or  to the entry you want.
2. Press  to dial or  to return to standby.

### 4.3 Edit a name and number

1. Press **MENU OK**. The display shows **Phonebook**.
2. Press **MENU OK**.
3. Scroll  to **Edit** and press **MENU OK**.
4. Scroll  or  to the entry you want to edit, or search alphabetically and press **MENU OK**. The existing name is displayed.
5. Press **MUTE BACK** to delete the name if required, then enter the new name and press **MENU OK**. The existing number is displayed.
6. Press **MUTE BACK** to delete the number if required, then enter the new number and press **MENU OK** to save.

### 4.4 Delete an entry

1. Press **MENU OK**. The display shows **Phonebook**.
2. Press **MENU OK**.
3. Scroll  to **Delete** and press **MENU OK**.
4. Scroll  or  to the entry you want to delete, or search alphabetically and press **MENU OK**. The display shows **Confirm?**.
5. Press **MENU OK** to confirm or **MUTE BACK** to cancel.



### 4.5 Delete all entries

1. Press **MENU OK**. The display shows **Phonebook**.
2. Press **MENU OK**.
3. Scroll  to **Delete all** and press **MENU OK**.
4. The display shows **Confirm?**.
5. Press **MENU OK** to confirm or **MUTE BACK** to cancel.

### 4.6 Store a quickdial number

Your phone can store 2 quickdial numbers for key 1 and 2. If a number is stored in the phonebook, it cannot be stored as a quickdial number.

The quickdial number can be up to 24 digits.

1. Press **MENU OK**. The display shows **Phonebook**.
2. Press **MENU OK**.
3. Scroll  to **Edit** and press **MENU OK**.
4. Scroll  or  to select the **Speed dial 1** or **Speed dial 2** you want to store the number under and press **MENU OK**.
5. Enter the number and press **MENU OK** to save.

#### Note

If you want to change the quickdial number follow the first 4 steps in 4.6 above and then delete the number there by pressing **MUTE BACK** and enter the new number, press **MENU OK** to save.

## 5. Call block









You can set the phone so that when certain phone numbers call the phone does not ring.

For this feature to work, you must subscribe to Caller ID Service from your network operator. A subscription fee may be payable.

You can go to **Call block** through the handset menu as described below, or by pressing the dedicated  key on the handset.









### 5.1 Switch anonymous call on/off

You can also set the phone so that any call that shows Private, Anonymous, Unavailable or Out of Area will not ring.











1. Press , scroll  to **Call block** and press .
2. Scroll  to **Call block**, press .
3. **Anonymous call** is displayed.
4. Press ,  or  to select **On** or **Off** and press  to confirm.

### 5.2 Switch block mode on/off

You can set the phone so that when phone numbers added to the blacklist call, the phone does not ring. Up to 100 numbers can be added to the blacklist.





1. Press , scroll  to **Call block** and press .
2. Scroll  to **Blacklist** and press .
3. **Block mode** is displayed.
4. Press ,  or  to select **On** or **Off** and press  to confirm.

### 5.3 Set a call block number

1. Press , scroll  to **Call block** and press .
2. Scroll  to **Blacklist** and press .
3. Scroll  to **Block number** and press .
4. Scroll  to **Add new** and press .
5. Enter the number you want to block. Press  to confirm.

#### Note





When you are storing an phone number in the Blacklist, you will need to store the full number including the dialling code for the number to be blocked.

If you want to change/delete the blacklist number follow the first 3 steps in 5.3 above, and then scroll to the slot where the number is stored and press . Delete the number by pressing  and either press  to save no number or enter the new number and press  to save.







## 6. Clock and alarm

If you have subscribed to Caller ID Service, the date and time will be set on your handset whenever a call is received. You can also manually set the date and time.



### 6.1 Date & time

1. Press **MENU** **OK**, scroll  to **Clock/Alarm** and press **MENU** **OK**.
2. **Date & time** is displayed. Press **MENU** **OK**.
3. Enter the date using the format MM-DD-YY e.g. 08/27/21 for 27 August 2021 and press **MENU** **OK**.
4. Enter the time (HH:MM) e.g 04.30 and press  or  to select **AM** or **PM** press **MENU** **OK** to confirm
5. Press  to return to standby.

### 6.2 Setting the alarm

1. Press **MENU** **OK**, scroll  to **Clock/Alarm**.
2. Press **MENU** **OK**. Scroll  to **Set alarm** and press **MENU** **OK**.
3. Scroll  or  to select **On** or **Off** and press **MENU** **OK**.
4. If you select **On** enter the time (HH:MM) e.g 04.30 and press  or  to select **AM** or **PM** press **MENU** **OK** to confirm.

#### Note

Once the alarm is set to on,  is displayed and the alarm will sound every day until it is turned off again. When the alarm sounds  flashes and **Alarm On** is displayed. Press any key to stop the sound.



## 7. Phone setup

### 7.1 Handset tones

#### 7.1.1 Ring volume

You can adjust the ringer volume and set different volume levels. Choose from 5 volume levels or Off.

1. Press **MENU OK**, scroll **↓** to **Personal set**.
2. Press **MENU OK**. The display shows **Handset tone**.
3. Press **MENU OK**. The display shows **Ring volume**.
4. Press **MENU OK**, scroll **↑** **vol. +** or **↓** **vol. -** to select the volume (1 -5 or Off).
5. Press **MENU OK** to confirm or **MUTE BACK** to return to the previous menu.

#### 7.1.2 Ring tones

You can set different ringer melodies for your external calls. Choose from 10 different ringer melodies.

You will hear a sample ring as you scroll to each ring melody.

1. Press **MENU OK**, scroll **↓** to **Personal set**.
2. Press **MENU OK**. The display shows **Handset tone**.
3. Press **MENU OK**. Scroll **↓** to **Ring tones**.
4. Press **MENU OK**, scroll **↑** **vol. +** or **↓** **vol. -** to select the melody (1 -10).
5. Press **MENU OK** to confirm or **MUTE BACK** to return to the previous menu.

#### 7.1.3 Key tones on/off

When you press a button on the handset keypad, you will hear a beep. You can switch these beeps on or off.

1. Press **MENU OK**, scroll **↓** to **Personal set**.
2. Press **MENU OK**. The display shows **Handset tone**.
3. Press **MENU OK**. Scroll **↓** to **Key tone**.
4. Press **MENU OK**, **↑** **vol. +** or **↓** **vol. -** to select **On** or **Off** and press **MENU OK** to confirm.

#### 7.1.4 Docking tone on /off

When you replace the handset in the base you will hear a double beep. You can switch this beep on or off.

1. Press **MENU OK**, scroll **↓** to **Personal set**.
2. Press **MENU OK**. The display shows **Handset tone**.
3. Press **MENU OK**. Scroll **↓** to **Docking tone**.
4. Press **MENU OK**, **↑** **vol. +** or **↓** **vol. -** to select **On** or **Off** and press **MENU OK** to confirm.

## 7.1.5 Battery tones

When your batteries are running low on charge you will hear a beep. You can switch this beep on or off.

1. Press **MENU OK**, scroll **↓** to **Personal set**.
2. Press **MENU OK**. The display shows **Handset tone**.
3. Press **MENU OK**. Scroll **↓** to **Battery tone**.
4. Press **MENU OK**, **▲ VOL+ CID** or **▼ VOL- CID** to select **On** or **Off** and press **MENU OK** to confirm.

## 7.2 Base tones

### 7.2.1 Ringer volume

You can adjust the base ringer volume and set different volume levels. Choose from 5 volume levels or Off.

1. Press **MENU OK**, scroll **↓** to **Personal set**.
2. Press **MENU OK**, scroll **↓** to **Base tone**.
3. Press **MENU OK**. The display shows **Base volume**.
4. Press **MENU OK**, scroll **▲ VOL+ CID** or **▼ VOL- CID** to select the volume (1-5 or Off).
5. Press **MENU OK** to confirm or **MUTE BACK** to return to the previous menu.

### 7.2.2 Ringer melody

You can set different ringer melodies for your external calls. Choose from 5 different ringer melodies.

You will hear a sample ring as you scroll to each ring melody.









1. Press **MENU OK**, scroll **↓** to **Personal set**.
2. Press **MENU OK**, scroll **↓** to **Base tone**.
3. Press **MENU OK**. Scroll **↓** to **Base melody**.
4. Press **MENU OK**, scroll **▲ VOL+ CID** or **▼ VOL- CID** to select the melody (1-5).
5. Press **MENU OK** to confirm or **MUTE BACK** to return to the previous menu.

## 7.3 Handset name









If you are using more than one handset with your phone base, you can set a personalized name for each handset to easily distinguish between them. A name can be up to 13 characters long.

1. Press **MENU OK**, scroll **↓** to **Personal set**.
2. Press **MENU OK**, scroll **↓** to **Phone name** and press **MENU OK**.
3. Enter the new handset name and press **MENU OK** to confirm.  
Delete the current name by pressing **MUTE BACK**.









## 7.4 Language

1. Press , scroll  to **Personal set**.
2. Press . Scroll  to **Language** and press .
3. Scroll  or  to select the required language and press  to confirm.

## 7.5 Auto answer

1. Press , scroll  to **Personal set**.
2. Press . Scroll  to **Auto answer**.
3. Press ,  or  to select **On** or **Off** and press  to confirm.

## 7.6 Auto hang-up

1. Press , scroll  to **Personal set**.
2. Press . Scroll  to **Auto hang-up**.
3. Press ,  or  to select **On** or **Off** and press  to confirm.

## 8. Advanced settings

### 8.1 Call list type

You can set the Call list to show All calls or Missed calls only. If All calls is selected, press  $\uparrow$  VOL+ key in idle and you can view all calls lists. If Missed calls is selected, press  $\downarrow$  VOL- key in idle and you can view missed calls only.

1. Press  $\text{MENU OK}$ , scroll  $\uparrow$  to **Advanced set** and press  $\text{MENU OK}$ .
2. The display shows **Call list type**, press  $\text{MENU OK}$ .
3. Scroll  $\uparrow$  VOL+ or  $\downarrow$  VOL- to select **All calls** or **Missed calls** and press  $\text{MENU OK}$  to confirm.

### 8.2 Area code

The area code must be 3 digits long.

1. Press  $\text{MENU OK}$ , scroll  $\uparrow$  to **Advanced set** and press  $\text{MENU OK}$ .
2. Scroll  $\uparrow$  to **Area code** is displayed. Press  $\text{MENU OK}$ .
3. Using the keypad enter the area code and press  $\text{MENU OK}$  to confirm.

### 8.3 Auto prefix

You can set the phone to detect a dialling number and replace it with another number. The number to be detected can be up to 5 digits long. It can be replaced with a number up to 10 digits.

1. Press  $\text{MENU OK}$ , scroll  $\uparrow$  to **Advanced set** and press  $\text{MENU OK}$ .
2. Scroll  $\uparrow$  to **Auto prefix**, press  $\text{MENU OK}$ .
3. **Detect digit** is displayed. Press  $\text{MENU OK}$ .
4. Enter the number you want to be detected and press  $\text{MENU OK}$ .
5. The display shows **Prefix**, press  $\text{MENU OK}$ .
6. Enter the number you want it replaced with.
7. Press  $\text{MENU OK}$  to confirm or  $\text{END}$  to return to standby.









### 8.4 Flash time

Depending on your country and network operator, your phone has the flash time set as long. It is unlikely that you need to change this setting unless advised to do so.

1. Press  $\text{MENU OK}$ , scroll  $\uparrow$  to **Advanced set** and press  $\text{MENU OK}$ .
2. Scroll  $\uparrow$  to **Flash time** and press  $\text{MENU OK}$ .
3. Press  $\uparrow$  VOL+ or  $\downarrow$  VOL- to select **80ms, 90ms, 100ms, 110ms, 160ms, 200ms, 250ms, 300ms, 400ms, 600ms, 700ms** or **900ms** and press  $\text{MENU OK}$  to confirm.







## 8.5 Dial mode

Your phone is set to tone dialling. You should only need to change this if connected to an older type of switchboard / PBX which requires pulse dialling.

1. Press **MENU** , scroll  to **Advanced set** and press **MENU** .
2. Scroll  to **Dial mode** and press **MENU** .
3. Press **MENU**  or **MENU**  to select **Tone** or **Pulse** and press **MENU**  to confirm.

## 8.6 Switch Auto clock on / off

If you have subscribed to Caller ID Service, the date and time will be set on all your handsets whenever a call is received. This feature can be set to On or Off.

1. Press **MENU** , scroll to **Advanced set** and press **MENU** .
2. Scroll  to **Auto clock** and press **MENU** .
3. Scroll  to **On** or **Off** then press **MENU**  to confirm.

## 8.7 Registration

Up to 4 handsets can be registered to one base station. Additional handsets must be registered to the base before you can use them.







- The instructions described below apply specifically to your handset. If you wish to register another manufacturer's handset, the instructions may vary. In this case, please refer to the manufacturer of the additional handset.
- The Master PIN is required before you can register or unregister handsets. The PIN is 0000.

### 8.7.1 Register a handset

**At the base:**









1. Press and hold the  button on the base until you hear a beep. You have 120 seconds in which to register a handset.

**At the handset:**

1. If the handset is not already registered to a base, press **MENU** .
2. Or if the handset is already registered to a base, press **MENU**  scroll  to **Advanced set** and press **MENU** . Scroll  to **Register** and press **MENU** .
3. When the display shows **PIN**, enter the base PIN and press **MENU** . When the handset registers with the base, it is assigned a handset number.

### 8.7.2 Deregister a handset

Use one handset to delete another. You cannot delete the handset that you are using.

1. Press **MENU** , scroll  to **Advanced set** and press **MENU** .
2. Scroll  to **Deregister** and press **MENU** .
3. Enter the 4 digit master PIN and press **MENU** . Display shows the first registered handset number.
4. Scroll **MENU**  or **MENU**  to select the handset you want to delete and press **MENU** . **Deregistered** is displayed on the handset screen.



## 8.8 Restore default settings

You can restore your phone to its default (original) settings.

All the handsets that are registered to the base will be retained.

### Important

Resetting your phone to its default settings will delete all entries in the Redial and Calls list, but Phonebook numbers will be retained. All handset and base settings will also be reset.

1. Press **MENU** **OK**, scroll  to **Advanced set** and press **MENU** **OK**.
2. Scroll  **VOL+** **CD** to **Reset** and press **MENU** **OK**.
3. **Confirm?** is displayed. Press **MENU** **OK**.

## 8.9 Default settings

Handset name	Handset
Ringer tone	1
Ringer volume	5
Ear volume	4
Hands-free volume	3
Flash time	700 ms
Phonebook	Unchanged
Calls list	Empty
Redial list	Empty
PIN code	0000
Dial mode	Tone
Ring delay	4
Answer mode	Record Also

## 9. Caller ID and the Calls list

### 9.1 Caller ID

To use Caller ID, you must first subscribe to the service from your network provider. A subscription fee may be payable.

If you have subscribed to a Caller ID Service, you will be able to see your caller's number on your handset (provided it is not withheld) prior to answering the call. The display can show the last 16 digits or 16 characters of the phone numbers or names.

If your caller's name and number are stored in the phonebook and a number match is found, you will see the caller's name on the display as well. To ensure that the caller's name is displayed, make sure you have stored the full telephone number, including the area code in the phonebook.

If the call is a private call, **Private** will be displayed.

If the number is unavailable, **Unavailable** will be displayed.

If the call is from the operator, **Operator** will be displayed.

If the call is from a payphone, **Payphone** will be displayed.

If the call is from a ringback request, **Ringback** will be displayed.

### 9.2 Calls list

The Calls list stores details of your last 50 incoming calls, including the phone number and date and time of the call.

The Calls list also alerts you when you have unanswered calls.

The caller's details are stored in the Calls list whether or not you have answered the call. The list is shared by all handsets registered to the base.



When the list is full, and a new call is received, the oldest entry will be deleted automatically.

When you have missed call(s) (incoming calls that you haven't answered) the display will show **X missed call(s)** and the **☎** will flash on all handsets registered to the base. Press **MENU** to see the callers details.





1. Press **▲** to open the Calls list. If there are no calls in the list, the display shows **List empty**.
  - The most recent number (and name if stored in the phonebook) is displayed.
2. Press **▲** or **▼** to scroll through the list.
  - If the call was answered, **☎** is displayed as you scroll to the entry. If the call was unanswered, **☎** is displayed as you scroll to the entry.
  - If the telephone number is longer than 16 digits, **▶** is displayed. Press **MUTE BACK** to see the remaining digits.
  - Press **MENU OK** to access the options to view, store the entry to your phonebook, delete the number, delete all numbers or block the number.

#### 9.2.1 View the Calls list

1. Press **▲** to open the Calls list.
2. Scroll **▲** or **▼** to the entry you want.









3. Press , the display shows **View**.
4. Press  to view the call name and time and date of the call, press  to switch between the name and number.

### 9.2.2 Dial a number in the Calls list









1. Press  to open the Calls list.
2. Scroll  or  to the entry you want.
3. Press  to dial the displayed entry.

### 9.2.3 Store a Calls list number to the phonebook







If a phone number is stored in the calls list but is not already in the phonebook you can save the name and number.

1. Press  to open the Calls list.
2. Scroll  or  to the entry you want.
3. Press , the display shows **View**.
4. Scroll  to **Save number** and press .
5. The display shows **Enter name**.
6. Enter the name and press . The number is displayed.
7. Edit the number if necessary, then press . The number is stored.









### 9.2.4 Delete an entry

1. Press  to open the Calls list.
2. Scroll  or  to the entry you want.
3. Press , the display shows **View**.
4. Scroll  to **Delete** and press . The display shows **Confirm?**.
5. Press  to confirm or  to cancel.

### 9.2.5 Delete the entire Calls list

1. Press  to open the Calls list.
2. Press , the display shows **View**.
3. Scroll  to **Delete all** and press . The display shows **Confirm?**.
4. Press  to confirm or  to cancel.

### 9.2.6 Store a number to the blacklist

1. Press  to open the Calls list.
2. Scroll  or  to the entry you want.
3. Press , the display shows **View**.
4. Scroll  to **Block number** and press . Scroll  to the next available slot and press  the number is displayed, press  to confirm.



## 10. Using your Answering Machine

The phone can digitally record up to 12 minutes of messages.

The answering machine can be operated from:

- the base
- the handset
- remotely, from any other DTMF telephone, see page 35.

### 10.1 Switch the answering machine on / off

**Via the handset**

1. Press **MENU OK**, scroll **▲ VOL+ / CD** or **▼ VOL- / CD** to **Answ. machine** and press **MENU OK**.
2. Scroll **▼** to **Voice answer** and press **MENU OK**.
3. Press **▲ VOL+ / CD** or **▼ VOL- / CD** to select either **Answer only**, **Record also** or **Off** and press **MENU OK** to confirm.

### 10.2 Listening to your messages

**Using the base:**

1. If there are new messages, press **▶ PLAY** and only they will be played. Press and hold **▶ PLAY** to play all messages.
2. If there are no new messages, press **▶ PLAY** all messages will be played.

**During playback:**

Press **▶ PLAY** to stop message playback.

Press **DELETE** to delete the current message.

**Note**

When in standby press and hold **DELETE** for 2 seconds to delete all old messages.

**Using the handset:**

1. If there is a new message press **MENU OK** and the new message will be played.
2. If there is no new message press **MENU OK**, scroll **▼** to **Answ. machine** and press **MENU OK**.
3. **Play** is displayed, press **MENU OK**.
4. The display shows the number of the message being played and the date and time the message was left will toggle on the screen.
5. During playback press **MENU OK** to display a list of options.
6. Use the **▲ VOL+ / CD** or **▼ VOL- / CD** to change the options.
  - **Repeat** press **MENU OK** to repeat current message.
  - **Next** press **MENU OK** to play next message.
  - **Previous** press **MENU OK** to play previous message.
  - **Delete** press **MENU OK** to delete the current message.
7. Press **⏏** to stop playback and return to standby.

## 10.3 Delete all messages

1. Press **MENU OK**, scroll **▲ VOL+ CID** or **▼ VOL- CID** to **Answ. machine** and press **MENU OK**.
2. Scroll **▼** to **Delete all** and press **MENU OK**.
3. Display shows **Confirm?**, press **MENU OK**.

## 10.4 Announcement

This is the message your callers hear on the answer machine. There are two pre-recorded outgoing messages, or you can record your own.

### 10.4.1 Record also

The pre-set Record also announcement, that allows your caller to leave a message, is 'Hello, your call cannot be taken at this moment, so please leave your message after the tone'.

### 10.4.2 Answer only

The caller can listen to your announcement but cannot leave a message. The pre-recorded message is 'Hello, your call cannot be taken at this moment, and you cannot leave a message, so please call later.'

### 10.4.3 Record, play or delete your own announcement

1. Press **MENU OK**, scroll **▼** to **Answ. machine** and press **MENU OK**.
2. Scroll **▼** to **Announcement** and press **MENU OK**.
3. Press **▲ VOL+ CID** or **▼ VOL- CID** to select either **Answer only** or **Record also** and press **MENU OK**.  
Scroll **▲ VOL+ CID** or **▼ VOL- CID** to select either **Play, Record** or **Use default** and press **MENU OK**.

If you select **Play** the current announcement will play back.

If you select **Record** once you hear the beep speak your announcement into the handset, to end recording press **MENU OK**. The announcement will play back.

If you selected **Use default** the display shows **Confirm?**, press **MENU OK** to confirm.

### 10.4.4 Select the announcement









Press **MENU OK**, scroll **▼** to **Answ. machine** and press **MENU OK**.

Scroll **▼** to **Voice answer** and press **MENU OK**.

Press **▲ VOL+ CID** or **▼ VOL- CID** to select either **Answer only** or **Record also** and press **MENU OK** to confirm.

## 10.5 Ring delay

Select the duration of rings before your answer machine picks up the call. Choose from 3-8 Rings or Toll Saver.

- When set to Toll Saver, if you have new messages your phone answers after 3 Rings.
  - If there are no new messages it will answer after 5 Rings. So you have the option to hang up, saving the time and cost of a call.
  - If the memory is full, it will automatically revert to Answer Only mode.
1. Press **MENU** , scroll  to **Answ. machine** and press **MENU** .
  2. Scroll  to **Ring delay** and press **MENU** . The handset will display the current setting.
  3. Use  or  to select the number of rings required and press **MENU**  to confirm.

## 10.6 Remote access

You can operate your answering machine from any DTMF phone by calling your product and entering a 4 digit security PIN code.

1. Dial your telephone number. When you hear your outgoing message, press #.
2. Enter your 4-digit PIN (default setting 0000) you will hear a confirmation beep. Use the keypad to operate the answering machine.

Press 1 for previous the message	Press 7 to turn On the answering machine
Press 2 to play messages	Press 8 to stop message playback
Press 3 to play the next message	Press 9 to turn Off the answering machine
Press 6 to delete the current message	

## 10.7 Remote access on/off and change remote PIN

1. Press **MENU OK**, scroll **▲ VOL+ / ▼ VOL-** or **□** to **Answ. machine** and press **MENU OK**.
2. Scroll **□** to **Remote access** and press **MENU OK**.
3. Scroll **▲ VOL+ / ▼ VOL-** to select **Activate**, **Deactivate** or **Change PIN**.
4. Press **MENU OK** to confirm.  
If you choose **Change PIN** enter the old PIN and press **MENU OK**.
5. Enter the new PIN and press **MENU OK**.
6. Re-enter the new PIN.
7. Press **MENU OK** to confirm.

## 10.8 Voice language

1. Press **MENU OK**, scroll **▲ VOL+ / ▼ VOL-** or **□** to **Answ. machine** and press **MENU OK**.
2. Scroll **□** to **Voice language** and press **MENU OK**.
3. Scroll **▲ VOL+ / ▼ VOL-** or **□** to select the required language and press **MENU OK** to confirm.

## 10.9 Memory full

The memory is full if there is less than 15 seconds of recording time left or if the maximum total of 59 messages has been reached.

When the memory becomes full:

-  flashes quickly on the handset display.
- The handset will display **Memory full** in idle mode
- The machine will automatically switch to Answer Only mode.

If the memory becomes full while a caller is leaving a message, they will hear a beep and the call is ended.

## 11. Help

### The is not scrolling during charge

- Bad battery contact – move the handset slightly.
- Dirty contact – Clean the battery contact with a cloth moistened with alcohol.
- Battery is full – no need to charge.

### No dialling tone

- No power – check the connections. Reset the phone: unplug and plug back in the mains.
- Batteries are empty – charge the batteries for at least 16 hours.
- You are too far from the base – move closer to the base.
- Wrong line cable – use the line cable provided.
- Line adaptor (when needed) is not connected to the line cord – connect the line adaptor (when needed) to the line cord.

### Poor audio quality

- The base is too close to electrical appliances, reinforced concrete walls or metal doorframes – move the base at least one meter away from any electrical appliances.

### The is blinking or has disappeared

- Handset is not registered to the base – register the handset to the base.
- You are too far from the base – move closer to the base.

### No ring tone

- The ring tone is deactivated.
- Increase the volume.
- Make sure the Call Block mode is switched to off.

### Caller ID service does not work

- Check your subscription with your network operator.

### A phonebook entry cannot be stored

- The phonebook is full. Delete an entry to free memory.

### No display

- Try recharging the batteries.
- Try disconnecting and connecting the base power supply.
- If LED is not lit up, then try disconnecting and connecting the base power supply.

### Unable to register another handset

- Maximum number of 4 handsets has been reached.
- The display shows **Searching**. You must unregister a handset in order to register a new one.

**Noise interference on your radio or television**

- Your base or charger cradle may be too close. Move it as far away as possible.

**Answer machine does not record messages**

- Switch the answer machine on.
- The memory may be full. If so, you will need to delete some messages.
- Answer mode may be set to Answer only. Change the mode to Record also.

**Cannot access messages remotely**

- Remote access may be switched off.
- If wrong PIN is entered a beep is played. You can enter the PIN again.

**Cannot record announcement**

- The memory may be full. If so, you will need to delete some messages.

**Answer machine stops automatically**

- The memory may be full. If so, you will need to delete some messages.
- The maximum message length is 3 minutes.

## 12. Technical Specifications

RF Frequency Bands	1.92GHz to 1.93GHz (DECT 6.0)
RF Transmission Power	0.115 W (maximum)
RF Channels	5 Duplex Channels
Power Supply for Base	DC 6.0V, 0.45A
Base Adaptor Power Rating	Input: AC 100V to 240V, 50/60Hz Output: DC 6.0V, 0.45A
Power Supply for Handset	2x DC 1.2V AAA 300mAh Ni-MH rechargeable batteries
Battery Information	HFR-AAA300 manufactured by Shenzhen Highpower Technology Co., LTD, or 30AAAHC manufactured by GPI International LTD
Power Supply for Charger Cradle	DC 6.0V, 0.45A
Charger Adaptor Power Rating	Input: AC 100V to 240V, 50/60Hz Output: DC 6.0V, 0.45A

## 13. General information

### Cleaning

- Clean the handset and base (or charger cradle) with a damp (not wet) cloth, or an anti-static wipe.
- Never use household polish as this will damage the product. Never use a dry cloth as this may cause static shock.

### Environmental

- Do not expose to direct sunlight.
- The handset may become warm when the batteries are being charged or during prolonged periods of use. This is normal. However, we recommend that to avoid damage, do not place the product on antique / veneered wood.
- Do not place your product on carpets or other surfaces which generate fibres, or place it in locations preventing the free flow of air over its surfaces.
- Do not submerge any part of your product in water and do not use it in damp or humid conditions, such as bathrooms.
- Do not expose your product to fire, explosives or other hazardous conditions.
- There is a slight chance that your phone could be damaged by an electrical storm. We recommend that you unplug the power and telephone line cord during an electrical storm.

### Product disposal instructions

#### Product disposal instructions for residential users

When you have no further use for it, please remove any batteries and dispose of them and the product according to your local authority's recycling processes. For more information, please contact your local authority or the retailer where the product was purchased.



#### Product disposal instructions for business users

Business users should contact their suppliers and check the terms and conditions of the purchase contract and ensure that this product is not mixed with other commercial waste for disposal.

### Consumer Products and Accessories Warranty

Thank you for purchasing this Motorola branded product manufactured under license by Meizhou Guo Wei Electronics Co. LTD., AD1 section, The economy exploitation area, Meizhou, Guangdong, P.R.China . ("MZGW")

#### What Does this Warranty Cover?

Subject to the exclusions contained below, MZGW warrants that this Motorola branded product ("Product") or certified accessory ("Accessory") sold for use with this product that it manufactured to be free from defects in materials and workmanship under normal consumer usage for the period outlined below. This Limited Warranty is your exclusive warranty and is not transferable.



## Who is covered?

This warranty extends only to the first consumer purchaser, and is not transferable.

## What will MZGW do?

MZGW or its authorized distributor at its option and within a commercially reasonable time, will at no charge repair or replace any Products or Accessories that do not conform to this limited warranty. We may use functionally equivalent reconditioned / refurbished / pre-owned or new Products, Accessories or parts.

## What Other Limitations Are There?

ANY IMPLIED WARRANTIES, INCLUDING WITHOUT LIMITATION THE IMPLIED WARRANTIES OF MERCHANTABILITY AND FITNESS FOR A PARTICULAR PURPOSE, SHALL BE LIMITED TO THE DURATION OF THIS LIMITED WARRANTY, OTHERWISE THE REPAIR OR REPLACEMENT PROVIDED UNDER THIS EXPRESS LIMITED WARRANTY IS THE EXCLUSIVE REMEDY OF THE CONSUMER, AND IS PROVIDED IN LIEU OF ALL OTHER WARRANTIES, EXPRESS OF IMPLIED. IN NO EVENT SHALL MOTOROLA OR MZGW BE LIABLE, WHETHER IN CONTRACT OR TORT (INCLUDING NEGLIGENCE) FOR DAMAGES IN EXCESS OF THE PURCHASE PRICE OF THE PRODUCT OR ACCESSORY, OR FOR ANY INDIRECT, INCIDENTAL, SPECIAL OR CONSEQUENTIAL DAMAGES OF ANY KIND, OR LOSS OF REVENUE OR PROFITS, LOSS OF BUSINESS, LOSS OF INFORMATION OR OTHER FINANCIAL LOSS ARISING OUT OF OR IN CONNECTION WITH THE ABILITY OR INABILITY TO USE THE PRODUCTS OR ACCESSORIES TO THE FULL EXTENT THESE DAMAGES MAY BE DISCLAIMED BY LAW.

Some jurisdictions do not allow the limitation or exclusion of incidental or consequential damages, or limitation on the length of an implied warranty, so the above limitations or exclusions may not apply to you. This warranty gives you specific legal rights, and you may also have other rights that vary from one jurisdiction to another.

Products Covered	Length of Coverage
<b>Consumer Products</b>	<b>One (1) year</b> from the date of the products original purchase by the first consumer purchaser of the product.
<b>Consumer Accessories (battery, power supply(s) and line cords)</b>	<b>Ninety (90) days</b> from the date of the accessories original purchase by the first consumer purchaser of the product.
<b>Consumer Products and Accessories that are Repaired or Replaced</b>	<b>The balance of the original warranty or for ninety (90) days</b> from the date returned to the consumer, whichever is longer.

## Exclusions

**Normal Wear and Tear.** Periodic maintenance, repair and replacement of parts due to normal wear and tear are excluded from coverage.

**Batteries.** Only batteries whose fully charged capacity falls below 80% of their rated capacity and batteries that leak are covered by this limited warranty.

**Abuse & Misuse.** Defects or damage that result from: (a) improper operation, storage, misuse or abuse, accident or neglect, such as physical damage (cracks, scratches, etc.) to the surface of the product resulting from misuse; (b) contact with liquid, water, rain, extreme humidity or heavy perspiration, sand, dirt or the like, extreme heat, or food; (c) use of the Products or Accessories for commercial purposes or subjecting the Product or Accessory to abnormal usage or conditions; or (d) other acts which are not the fault of Motorola or MZGW are excluded from coverage.

**Use of Non-Motorola branded Products and Accessories.** Defects or damage that result from the use of Non-Motorola branded or certified Products or Accessories or other peripheral equipment are excluded from coverage.

**Unauthorized Service or Modification.** Defects or damages resulting from service, testing, adjustment, installation, maintenance, alteration, or modification in any way by someone other than Motorola, MZGW or its authorized service centers, are excluded from coverage.

**Altered Products.** Products or Accessories with (a) serial numbers or date tags that have been removed, altered or obliterated; (b) broken seals or that show evidence of tampering; (c) mismatched board serial numbers; or (d) nonconforming or non-Motorola branded housings, or parts, are excluded from coverage.

**Communication Services.** Defects, damages, or the failure of Products or Accessories due to any communication service or signal you may subscribe to or use with the Products or Accessories is excluded from coverage.

### How to Obtain Warranty Service or Other Information?

To obtain service or information, please call: 1-833-468-1468.

You will receive instructions on how to ship the Products or Accessories at your expense and risk, to a MZGW Authorized Repair Center.

To obtain service, you must include: (a) the Product or Accessory; (b) the original proof of purchase (receipt) which includes the date, place and seller of the Product; (c) if a warranty card was included in your box, a completed warranty card showing the serial number of the Product; (d) a written description of the problem; and, most importantly; (e) your address and telephone number.

## FCC, ACTA and IC regulations

### FCC Part 15

This equipment has been tested and found to comply with the requirements for a Class B digital device under Part 15 of the Federal Communications Commission (FCC) rules. These requirements are intended to provide reasonable protection against harmful interference in a residential installation. This equipment generates, uses and can radiate radio frequency energy and, if not installed and used in accordance with the instructions, may cause harmful interference to radio communications. However, there is no guarantee that interference will not occur in a particular installation. If this equipment does cause harmful interference to radio or television reception, which can be determined by turning the equipment off and on, the user is encouraged to try to correct the interference by one or more of the following measures:

- Reorient or relocate the receiving antenna.
- Increase the separation between the equipment and receiver.
- Connect the equipment into an outlet on a circuit different from that to which the receiver is connected.
- Consult the dealer or an experienced radio/TV technician for help.

Changes or modifications to this equipment not expressly approved by the party responsible for compliance could void the user's authority to operate the equipment.

This device complies with Part 15 of the FCC rules. Operation is subject to the following two conditions: (1) this device may not cause harmful interference, and (2) this device must accept any interference received, including interference that may cause undesired operation. Privacy of communications may not be ensured when using this telephone.

To ensure safety of users, the FCC has established criteria for the amount of radio frequency energy that can be safely absorbed by a user or bystander according to the intended usage of the product. This product has been tested and found to comply with the FCC criteria. Both the Handset may be safely held against the ear of the user. The telephone base shall be installed and used such that parts of the user's body other than the hands are maintained at a distance of approximately 20 cm (8 inches) or more.

This Class B digital apparatus complies with Canadian ICES-003.

This device complies with Industry Canada licence-exempt RSS standard(s). Operation is subject to the following two conditions: (1) this device may not cause interference, and (2) this device must accept any interference, including interference that may cause undesired operation of the device.

## FCC Part 68 and ACTA

This equipment complies with Part 68 of the FCC rules and with technical requirements adopted by the Administrative Council for Terminal Attachments (ACTA). This Product Complies With 47CFR PART 68.

The plug and jack used to connect this equipment to premises wiring and the telephone network must comply with applicable Part 68 rules and technical requirements adopted by ACTA. A compliant telephone cord and modular plug is provided with this product. It is designed to be connected to a compatible modular jack that is also compliant. An RJ11 jack should normally be used for connecting to a single line and an RJ14 jack for two lines. See Installation Instructions in the User's Guide.

The Ringer Equivalence Number (REN) is used to determine how many devices you may connect to your telephone line and still have them ring when you are called. The REN for this product is encoded as the 6th and 7th characters following the US: in the product identifier (e.g., if ## is 03, the REN is 0.3). In most, but not all areas, the sum of all RENs should be five (5.0) or less. For more information, please contact your local telephone company.

This equipment may not be used with Party Lines. If you have specially wired alarm dialing equipment connected to your telephone line, ensure the connection of this equipment does not disable your alarm equipment. If you have questions about what will disable alarm equipment, consult your telephone company or a qualified installer.

If this equipment is malfunctioning, it must be unplugged from the modular jack until the problem has been corrected. Repairs to this telephone equipment can only be made by the manufacturer or its authorized agents. For repair procedures, follow the instructions outlined under the Limited Warranty.

If this equipment is causing harm to the telephone network, the telephone company may temporarily discontinue your telephone service. The telephone company is required to notify you before interrupting service. If advance notice is not practical, you will be notified as soon as possible. You will be given the opportunity to correct the problem and the telephone company is required to inform you of your right to file a complaint with the FCC. Your telephone company may make changes in its facilities, equipment, operation, or procedures that could affect the proper functioning of this product. The telephone company is required to notify you if such changes are planned.

If this product is equipped with a corded or cordless handset, it is hearing aid compatible. If this product has memory dialing locations, you may choose to store emergency telephone numbers (e.g., police, fire, medical) in these locations. If you do store or test emergency numbers, please:

- Remain on the line and briefly explain the reason for the call before hanging up.
- Perform such activities in off-peak hours, such as early morning or late evening.

## **FCC Exposure to Radio Frequency (RF) Signals**

### **For Handset**

This is a radio transmitter and receiver. It is designed and manufactured not to exceed the emission limits for exposure to radio frequency (RF) energy set by the Federal Communications Commission (FCC) of the U.S. Government. These limits are part of comprehensive guidelines and establish permitted levels of RF energy for the general population. The guidelines are based on the safety standards previously set by both U.S. and international standards bodies.

These standards include a substantial safety margin designed to assure the safety of all persons, regardless of age and health. This device and its antenna must not be collocated or operating in conjunction with any other antenna or transmitter. This product has been shown to be capable of compliance for localized specific absorption rate (SAR) for uncontrolled environment/general population exposure limits specified in ANSI/IEEE Std. C95.1-1992 and had been tested in accordance with the measurement procedures specified in FCC/OET Bulletin 65 Supplement C (2001) and IEEE 1528.

### **For Base**

This equipment complies with FCC radiation exposure limits set forth for an uncontrolled environment. This equipment should be installed and operated with minimum distance 20cm between the radiator& your body.

This transmitter must not be co-located or operating in conjunction with any other antenna or transmitter.

## **ISED Warning**

This device complies with Innovation, Science, and Economic Development Canada licence-exempt RSS standard(s). Operation is subject to the following two conditions:

- (1) this device may not cause interference, and
- (2) this device must accept any interference, including interference that may cause undesired operation of the device.

The device is compliance with RF exposure guidelines, users can obtain Canadian information on RF exposure and compliance.

### **ISED Specific Absorption Rate (SAR) information**

#### **For Handset**

SAR tests are conducted using standard operating positions accepted by the ISED with device transmitting at its highest certified power level in all tested frequency bands, although the SAR is determined at the highest certified power level, the actual SAR level of the device while operating can be well below the maximum value. Before a new model device is available for sale to the public, it must be tested and certified to the ISED that it does not exceed the exposure limit established by the ISED, tests for each device are performed in positions and locations as required by the ISED. For body worn operation, this model device has been tested and meets the ISED RF exposure guidelines when used with an accessory designated for this product or when used with an accessory that contains no metal.

#### **For Base**

This equipment complies with ISED radiation exposure limits set forth for an uncontrolled environment. This equipment should be installed and operated with minimum distance 20cm between the radiator& your body.

This transmitter must not be co-located or operating in conjunction with any other antenna or transmitter.

### **CS-03:**

This product meets the applicable ISED technical specifications.

The REN is an indication of the maximum number of terminals allowed to be connected to a telephone interface. The termination on an interface may consist of any combination of devices subject only to the requirement that the sum of the Ringer Equivalence Numbers of all the devices does not exceed five.

**REN: 0.1**

## California Energy Commission(CEC)/Canada Battery Charger(NRCAN) Battery Charging Testing

It is not necessary to activate testing mode during normal usage, unless you want to charge the battery only and disable all telephone functions.

### To activate the battery charge testing mode:

1. Ensure handset and base are powered and in range.
2. Press **MENU**  
**OK** , and enter **\*2201** to enter **Test Mode**.
3. Select **Test Base** and press **MENU**  
**OK** .
4. Scroll **▲**  
**VOL+ /**  
**CD-** to **CEC Mode** and press **MENU**  
**OK** to confirm.
5. Press **⏻**.

### To deactivate/exit the battery charge testing mode.

1. Unplug the base power, reconnect the base power.
2. Remove the handset battery, then insert the battery into the handset to power up the handset.
3. After Handset link to base, it is back to normal mode.Note

If you do not press any button on the handset for 30 seconds the display will automatically return to standby. It will also return to standby when the handset is placed on the base or charger cradle.

Manufactured, distributed or sold by Meizhou Guo Wei Electronics Co. LTD., official licensee for this product. MOTOROLA and the Stylized M Logo are trademarks or registered trademarks of Motorola Trademark Holdings, LLC. and are used under license. All other trademarks are the property of their respective owners. © 2021 Motorola Mobility LLC. All rights reserved.

Version 1.3 (EN\_US)

