



motorola

Motorola AXH01

Wireless Home Telephone
with Alexa Built-In

Warning: Charge the handset for 16 hours before use.

Welcome...

to your new Motorola AXH01 wireless home telephone with Alexa Built-In!

Before you can use Alexa you will need

- An active landline home telephone service.
- An active Caller Display subscription.
- An active internet connection and router.
- An Amazon account.
- The Amazon Alexa app.

Alexa

- Access Alexa at the touch of a button on your cordless handset.
- Instant access to your cell phone contacts to make calls via the Motorola AXH01 handset over your land line.

General Features

- 2.0" 65k TFT bright backlit colour display (176 x 220).
- Laser etched backlit keypad.
- Polyphonic ringer melodies.
- Caller ID shows you who's calling and see details of the callers in a Calls lists.¹
- Make internal calls, transfer external calls and hold 3-way conversation.

Need help?

If you have any problems setting up or using your Motorola AXH01, please contact Customer services: xxxxxxxx

Alternatively, you may find the answer in the 'Help' section at the back of this guide.

Please note that this equipment is not designed for making emergency telephone calls when the power fails. Alternative arrangements should be made for access to emergency services.

¹ Some features may require a subscription from your local telephone company.

This User Guide provides you with all the information you need to get the most from your phone.

Before you make your first call or use Alexa you will need to set up your phone. Follow the simple instructions in 'Getting Started', on the next few pages.

Got everything?

- AXH handset
- AXH charger cradle
- AXH base
- AC power adaptor for the base
- AC power adaptor for the charger cradle
- 2 x rechargeable Ni-MH battery cells
- Ethernet cable
- Telephone line cord

For a better tomorrow

We make every effort through our design, research, engineering and supply chain management to make better products for everyone, focusing on both social and environmental responsibility.

- Eco friendly packaging with a minimum 20% post consumer recycled content.
- Phone housing is built with a minimum of 25% post consumer recycled content plastic.

1.	Getting started	7
2.	Getting to know your phone	11
3.	Alexa	16
3.1	Download the Amazon Alexa app and sign in	16
3.2	Download the Motorola AXH01 App and log into Alexa	16
3.3	To activate Alexa	17
4.	Using the phone	18
4.1	Switch the handset on / off	18
4.2	Calls	18
4.2.1	Make a call	18
4.2.2	Preparatory dialling	18
4.2.3	Make a call using speed dial keys	18
4.2.4	End a call	18
4.2.5	Receive a call	19
4.3	Adjust the earpiece or hands-free volume	19
4.4	Adjust the ringer volume	19
4.5	Mute	19
4.7	Intercom, second calls, transferring calls and conference calls	19
4.7.1	Making an internal call	19
4.7.2	Receiving an internal call	19
4.7.3	Making a second call	20
4.7.4	Conference calls	20
4.7.5	Transferring calls	21
4.7.6	Receiving a second call (call waiting)	21
4.8	Lock / unlock the keypad	21
5.	Contacts	22
5.1	View the details or dial an entry	22
5.2	Redial an entry	22
6.	Calls List	23
6.1	New calls alert	23
6.2	Dial a number in the calls list	23
6.3	Save a calls list number to the contact list	23
6.4	View the details of an entry	24
6.5	Delete an entry	24
6.6	Delete all calls list	24

6.7	Predial an entry in the calls list.....	24
7.	Clock & alarm	25
7.1	Set the date and time.....	25
7.2	Set the alarm.....	25
8.	Call settings	26
8.1	Auto hang-up	26
8.2	Auto answer	26
8.3	Add a speed dial number.....	26
8.4	Edit / Delete a speed dial number	27
9.	Handset settings	28
9.1	Sound.....	28
9.1.1	Ringer volume	28
9.1.2	Ringer melody.....	28
9.1.3	Key beep.....	28
9.1.4	Out of range tone	29
9.1.5	Cradle tone	29
9.2	Display.....	29
9.2.1	Display contrast.....	29
9.2.2	Wallpaper	29
9.2.3	Display backlight.....	30
9.3	Language.....	30
9.4	Registration.....	30
9.5	De-registering a handset.....	31
9.6	Handset name	31
9.7	Restore to default settings.....	31
9.8	Handset version.....	31
10.	Advanced settings	32
10.1	DECT settings.....	32
10.1.1	Change PIN.....	32
10.1.2	Clock master	32
10.1.3	ECO +.....	32
10.1.4	Base version.....	32
10.1.5	Restore to default settings.....	33
10.2	Internal names.....	33
10.3	Line settings.....	33
10.3.1	Line name.....	33

10.3.2	Line ID	33
10.4	Line selection.....	34
10.5	Default settings.....	34
11.	Technical Specifications.....	35
12.	Help.....	36
13.	General information	38

1. Getting started

Location

Important

Do not place your Motorola AXH01 in the bathroom or other humid areas.

Place your Motorola AXH01 base within reach of the AC power outlet, telephone wall socket and router. The AC outlet should be installed near the equipment and should be easily accessible.



Note

If you are wall mounting your phone please refer to the wall mount template on page 46.

Handset range

The unit has a range of up to 300 meters outdoors when there is a clear line of sight between the base and handset. Any obstruction between the base and handset will reduce the range significantly. With the base indoors and the handset either indoors or outdoors, the range will normally be up to 50 meters. Thick concrete and stone walls can severely affect the range.

Signal strength

The  on your handset indicates that you are within range of the base. When out of range of the base, the handset will display . If you are on a call, and the out of range tone is set to on, you will hear a warning beep.

The line will hang up if the handset moves out of range of the base. Move closer to the base and the handset will automatically reconnect.



Setting up

Important

The base station must be plugged into the AC power outlet at all times. Use only the AC power adaptor and telephone line cord supplied with the product.

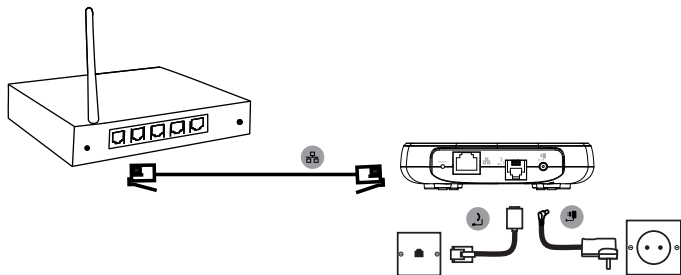
Connecting the base



1. Plug the telephone line cord into the socket marked  on the rear of the base and plug the other end into the telephone wall socket.
2. Plug the AC power adaptor into the socket marked  on the rear of the base and plug the other end into the AC outlet. Switch on the AC power.
3. Plug the Ethernet cable into the socket marked  on the rear of the base and plug the other end into the router.

Connecting the charger

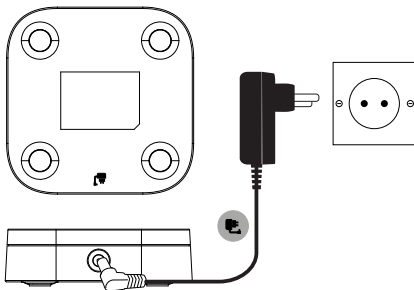

1. Plug the AC power adaptor into the socket marked  on the rear of the charger and plug the other end into the AC power outlet. Switch on the AC power.

Installing and charging the handset

1. Remove the battery cover from the back of the handset and insert the rechargeable Ni-MH battery cells supplied. Please note the '+' and '-' markings inside the battery compartment and insert in the correct direction.

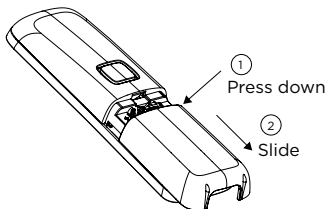

2. Slide the battery cover back into place.
3. If you are charging the batteries for the first time, place the handset on the charger to charge for at least 16 hours continuously.
4. When the handset is fully charged,  will appear steady on the display.

Important

Warning! Use only the approved rechargeable Ni-MH battery cells (2 x AAA Ni-MH 750mAh rechargeable batteries) supplied with your Motorola AXH01.

Battery low warning

If you hear a warning beep every 60 seconds during a call, you will need to recharge the handset before you can use it again.

When charging,  will scroll on the display.

Battery performance

In ideal conditions, fully charged batteries should give up to 17.5 hours talk time or up to 300 hours standby time on a single charge.¹

Note that new batteries do not reach their full capacity until they have been put to normal use for several days.

To keep your batteries in the best condition, leave the handset off the charger for a few hours at a time.

Running the batteries right down at least once a week will help them last as long as possible.

The charge capacity of rechargeable batteries will reduce with time as they wear out, giving the handset less talk / standby time. Eventually they will need to be replaced.

After charging your handset for the first time, subsequent charging time is about 6–8 hours a day. Batteries and handset may become warm during charging. This is normal.

¹All talk and standby times are approximate and depend on features selected and usage pattern.

Date and time

The date and time is set automatically when registered to the base. You can change the date and time format to show MM/DD or DD/MM and 12 hours or 24 hours.

Note

The phone can be set so that the base or handset can be the clock master, once set this will sync across all handset. If you have the handset set to clock master as well as changing the format you can set the date and time manually.

1. Press **Menu**, scroll **▶** to **Clock & Alarm** and press **Select**.
2. **Date/Time** is highlighted. Press **Select**.
3. To change the date format, scroll **▼** to **Date Format** and scroll **◀** or **▶** to select either **MM/DD** or **DD/MM**.
4. Scroll **▲** to **Enter Date**, enter the date, e.g. when set to MM/DD, 08/27/19 for 27 August 2019 and press **Ok**.
5. Once the date is set, to change the time format, scroll **▼** to **Time Format** and scroll **◀** or **▶** to select either **12 Hours** or **24 Hours**.

6. Scroll ▲ to **Enter Time**, enter the time, e.g. when set to 24 Hours, 1430 for 2:30pm and press **Save**.
If the current time format setting is 12 hour, scroll ◀ or ▶ to select **AM** or **PM**.
7. Press  to return to standby.

Setting up Alexa

In order to set-up the Motorola AXH01 to work with Alexa, landline and Alexa2Alexa (A2A) calling you need the following:

1. An active landline home telephone service.
2. An active Caller Display subscription.
3. An active internet connection and router.
4. An Amazon account. <https://www.amazon.com>
5. The Amazon Alexa app. Download it free to your cell phone.
Start the download process in your mobile browser at <http://alexa.amazon.com>

Your Motorola AXH01 is now ready for use.

2. Getting to know your phone

Overview of your handset

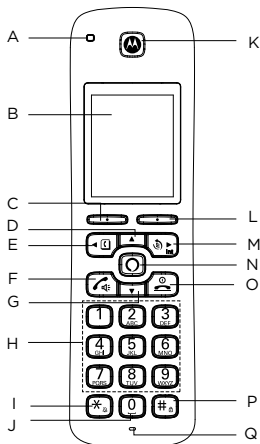

A Ring indicator LED

Flashes when the phone rings.

B Display

For display icons, see "Display" on page 13.

C Left softkey / Menu / OK

Enter the main menu.

Select the option displayed on screen.

Confirm a menu option.

D Scroll up / Volume up

Scroll up through lists and menus.

During a call, press to increase the earpiece and hands-free volume.

In standby, press to enter the handset ringer volume setting.

When you have entered the handset ringer volume setting, press to increase the handset ringer volume. When the phone is ringing, press to increase the handset ringer volume.

E Scroll left / Contacts / Flash

Scroll left when in the menu options.

Press to move the cursor to the left.

Press to enter the contact list menu.

Press and hold for switchboard / PABX services and some network services.

F Talk / Hands-free / Line selection

Make or answer a call.

Activate and deactivate hands-free during a call.

Press and hold to open the Line selection menu.

G Scroll down / Volume down

Scroll down through lists and settings.

During a call, press to decrease the earpiece and hands-free volume.

In standby, when you have entered the handset ringer volume setting, press

to decrease the handset ringer volume. When the phone is ringing press to decrease the handset ringer volume.

H Speed dial keys

Press and hold to view / edit / dial the speed dial information for that key.

I * / Change case / Pulse to tone dialling / Ringer off

Press to dial a *.

Press to change the case when entering letters / editing.

During a call, press and hold to switch from pulse dialling to tone dialling.

(This feature is base dependent).

Press and hold in standby to turn the ringer on / off.

J Space / Pause

Press to insert a space during text editing.

Press and hold to enter a pause (P) when dialling or storing numbers or when in call mode.

K Earpiece

L Right softkey / Clear / Back / Call list

Delete characters on screen when entering names and numbers.

When **Back** is displayed on the screen, press to go back to the previous menu.

In standby, press to enter the call list.

M Scroll right / Redial / Intercom

Scroll right when in the menu options.

Press to move the cursor to the right.

Press to enter the redial list.

In standby, press and hold for intercom.

N Alexa key

Press to activate Alexa.

O End call / Power on/off / Exit

Press to end a call.

In standby, press and hold to switch the phone off.

When the handset is switched off press to turn the handset on.

When in the menu press to return to standby.

P # / Keypad lock













Dial a #.

Press and hold to lock the keypad.

In editing mode, press to bring up symbols.

Q Microphone

Display overview

-  Signal icon
-  Displays when in hands-free mode
-  Mute is activated
-  Ringer is switched off
-  Indicates a missed call
-  Indicates a message has been left
-  Alexa Notification icon
-  Alarm is set
-  Batteries are fully charged
-  Batteries are partially charged
-  Batteries are running low
-  Batteries are almost fully discharged
-  Batteries are empty

Overview of the charger

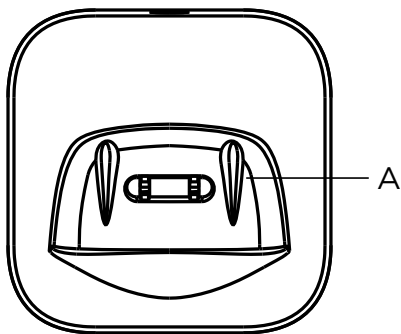



A Charging contacts

Navigating the menu

Your Motorola AXH01 has an easy to use menu system on the handset.

Each menu has a list of options, which you can see on the menu map on the following page.

Scrolling through menus

1. From the standby screen, press **Menu**.
The main menu is opened.
2. Use the ▲ / ▼ /  (◀) /  (▶) keys to scroll through the menu.
3. Left softkey - press to action the corresponding word prompt shown in the lower left corner of the display.
Right softkey - press to action the corresponding word prompt in the lower right corner of the display.
4. Press  to return to standby.

Menu map

Contacts

Press **[1]** to enter the phonebook.

View ¹

Predial ¹

Call List

Missed Calls

Received Calls

Outgoing Calls

Accepted Calls

All Call

Clock & Alarm

Date/Time

Alarm

Call Settings

Auto Hang-up

Auto Answer

Speed Dial

Handset Settings

Sound

Ringer Volume

Ringtone

Key Beep

Out Range Tone

Cradle Tone

Display

Contrast

Wallpaper

Backlight Timeout

Language

Registration

Handset Name

Handset Setback

Handset Version

Advance Settings

DECT Settings

Change PIN

Clock Master

ECO +

Base Version

Base Setback

Internal Names

Line Settings

Line Selection

3. Alexa

3.1 Setting up

Download the Amazon Alexa app

With the Amazon Alexa app, you can set up your phone, manage shopping lists, alarms, music, and much more. The Amazon Alexa app is available on cell phones with:

Fire OS 3.0 or higher

Android 5.0 or higher

iOS 9.0 or higher

To download the Amazon Alexa app, go to the app store on your mobile device and search for “Amazon Alexa app.” Select and download the app.

Once you have downloaded the Amazon Alexa app go to your cell phone’s home screen and click on the icon, you will then be asked to log using your Amazon account details.

Download the hello voice app and log into Alexa

Download the hello voice app to your cell phone (Go to the app store on your mobile device and search for hello voice app). Select and download the app.

Ensure your cell phone is using the same Wi-Fi connection as the router your base is plugged into.

Once you have downloaded the app, go to your cell phone’s home screen and click on the icon.

Once the app is open it will automatically search for all active devices. Select the device you want and select **Done**.

You will then be asked to log into Amazon Alexa through the hello voice app.

Select **Amazon Alexa Login**, you will then be asked to log using your Amazon account details.

After you get the “Login success” page you can start using your AXH01.

3.3 To activate Alexa



1. Press  to activate Alexa, the display will show **Alexa listening...** and a beep will be heard.

2. You can then ask Alexa what you need.
For example:
Alexa what's the weather today.
The screen will display **Alexa thinking...**

3. The display will show **Alexa speaking...** when a response is provided.

4. Using the phone



4.1 Switch the handset on / off

1. To power the handset off, press and hold  for about 5 seconds.
2. **Confirm?** is displayed, press **Yes** to confirm or **No** to cancel.
3. Press  to turn the handset back on.

4.2 Calls

4.2.1 Make a call



When making calls you can pre set the line selection to auto, manual or individual line selection, see page 35. The default setting is auto, when a call is made the base will automatically select the line.

1. Press .
2. Dial the number.
If the line selection is set to manual, press  scroll **▲** or **▼** to highlight **Auto** or **Line Name** and press **Select**, if **Line Name** is selected scroll **▲** or **▼** to the desired line and press **Select**, then dial the number.
3. Press  again to switch to hands-free call.



Note

Your phone will automatically time the duration of all external calls, the call timer will display on the screen. When the call ends, the total duration of your talk time is shown for 1 second.

4.2.2 Preparatory dialling

1. Dial the number first. If you make a mistake press **Clear** to delete the last digit.
2. Press  to dial.
If the line selection is set to manual, press  scroll **▲** or **▼** to highlight **Auto** or **Line Name** and press **Select**, if **Line Name** is selected scroll **▲** or **▼** to the desired line and press **Select**.
3. Press  again to switch to hands-free call.

4.2.3 Make a call using speed dial keys

1. Press and hold the relevant keypad number (1-9), press  the number will be dialled automatically.
If the line selection is set to manual, press  scroll **▲** or **▼** to highlight **Auto** or **Line Name** and press **Select**, if **Line Name** is selected scroll **▲** or **▼** to the desired line and press **Select**.

Note

To assign a speed dial number, see page 26.

4.2.4 End a call

Press , or place the handset back on the charger.

Note

You can end calls simply by placing the handset on the charger. To turn this feature off, see Auto hang-up, see page 26 .

4.2.5 Receive a call

When you receive an external call, the phone rings, , the line information and the phone number (or name if stored in the contact list) is displayed.

1. Press  to answer the call and press  again to switch to hands-free.

Note

If you prefer for the call to be automatically answered when you lift the handset off the charger, you will need to switch Auto answer on, see page 26.

4.3 Adjust the earpiece or hands-free volume

1. During a call, press ▲ to increase and ▼ to decrease the volume level. There are 5 levels to choose from, volumes 1-5.

4.4 Adjust the ringer volume

In standby, press ▲ and then scroll ▲ or ▼ to select the desired volume level.

While the phone is ringing, press ▲ or ▼ to select the desired volume level.

Press and hold  in standby to turn the ringer off. Press and hold again to turn the ringer back on.

4.5 Mute

1. During a call press **Mute**,  is displayed.
2. To turn mute off, press **Unmute**.

4.7 Intercom, second calls, transferring calls and conference calls

4.7.1 Making an internal call

If more than one handset is registered to the base, an internal call can be made between handsets and a second call can also be made, see page 20.

1. If 2 handsets are registered to the base, press **Intercom** and the other handset rings automatically.
2. If 2 or more handsets are registered to the base, press **Intercom** and scroll ▼ to select the handset that is to be called, press **Select**.

4.7.2 Receiving an internal call

When an internal call is received, the handset name or number that is calling is displayed.

1. Press **Silence** to stop the handset ringing.
2. Press **Reject** to reject the call.
3. Press  to answer the call.

4.7.3 Making a second call

When on an internal or external call you can make a second internal or external call without ending the first call.

Second internal call

During a call:

1. Press **Option** and scroll ▼ **Intercom** and press **Select**.
2. If 2 handsets are registered to the base the other handset rings automatically.
3. If 2 or more handsets are registered to the base, scroll ▼ to select the handset that is to be called, or select **All Handsets** to ring all handsets, press **Select**.
4. When the second handset answers you can have an internal conversion.
5. Press **Option**, then scroll ▲ or ▼ to the required option.
Switch Calls - to switch between the 2 calls.
Conference - to join the 2 calls to make a 3-way call.
Transfer - to transfer the call to the second handset.
Release Active - to end the active call.

Second external call

During a call:

1. Press **Option** and scroll ▼ to **Add Call**, press **Select**.
2. You can either:
Dial the number manually.
Press **[□]** - to dial a number in the contact list.
Press ▼ - to dial a number in the call list.
Then press **Dial** to dial.
3. If the line selection is set to manual, press **[☎]** scroll ▲ or ▼ to highlight **Auto** or **Line Name** and press **Select**, if **Line Name** is selected scroll ▲ or ▼ to the desired line and press **Select**.
4. When the second call answers you can have a conversion.
5. Or select the following options:
Press **Option**, then scroll ▲ or ▼ to the required option.
Switch Calls - to switch between the 2 calls.
Conference - to join the 2 calls to make a 3-way call.
Transfer - to transfer the call to the second handset.
Release Active - to end the active call.

4.7.4 Conference calls

If intrusion calls is set to allowed, see page 34, when a handset is on a call a second handset can initiate a conference call. Press **[☎]** on the second handset and it will take the same line and a conference call will begin.

4.7.5 Transferring calls

If when transferring a call the second handset doesn't answer, then you can press **Option**, **Transfer** is highlighted, press **Select** to transfer the call to the second handset unannounced.

4.7.6 Receiving a second call (call waiting)

When on an internal or external call you can receive a second internal or external call without ending the first call.

When there is a second call the call waiting screen will be displayed, you can either press **Accept** to accept the second call and put your first caller on hold or **Reject** to reject the second call.

If the call is accepted, press **Option**, then scroll ▲ or ▼ to the required option.

Switch Calls - to switch between the 2 calls.



Conference - to join the 2 calls to make a 3-way call.

Transfer - to transfer the call to the second handset.

Release Active - to end the active call.

4.8 Lock / unlock the keypad

The keypad can be locked so that it cannot be operated accidentally.

1. Press and hold , **Keys Locked** is displayed.
2. Press and hold  again to unlock the keypad.

Note

When the keypad is locked an incoming call can still be answered and the handset will operate as normal. When the call ends, the keypad lock comes on again.

5. Contacts

You can enter the contacts list by pressing **C**. The list is stored in the base and you cannot add, edit or delete contacts from the list.,

5.1 View the details or dial an entry

1. Press **C** to enter the contacts list.
2. Scroll **▲** or **▼** to the entry you want or search alphabetically.
3. Press **☎** to dial.
4. Or to see the details, press **Option** scroll **▼** to **View** and press **Select**.

5.2 Predial an entry

1. Press **C** to enter the contacts list.
2. Scroll **▲** or **▼** to the entry you want or search alphabetically and press **Option**.
3. Scroll **▼** to **Predial** and press **Select**.
4. If the entry has more than one number stored, **▼** to the number you require, press **Select**.
5. The number is displayed.
6. Press **☎** to dial.

6. Calls List

Provided the identity of the caller is not withheld, the number of the caller will be displayed together with the date and time of the call (if provided by the network).

You can either enter the calls list by pressing ▼ or through the handset menu. You can also enter the outgoing calls list directly by pressing ►.

Note



If the caller's number is stored in your contact list along with a name, when you receive a call the name will also be displayed.

6.1 New calls alert

You can either enter the calls list by pressing ▼ or through the handset menu. You can also enter the outgoing calls list directly by pressing ►.

When you have new missed calls (incoming calls that you haven't answered), the display shows **X Missed Call(s)** and  flashes.

6.2 Dial a number in the calls list

1. Press ▼, scroll ▲ or ▼ to highlight the calls list (**Missed Calls, Received Calls, Outgoing Calls, Accepted Calls, All Call**) you want.
2. Press **Select**, the most recent number (or name if stored in the contact list) is displayed.
3. Scroll ▲ or ▼ to the entry you want to dial.
4. Press  to dial.
If the line selection is set to manual, press  scroll ▲ or ▼ to highlight **Auto** or **Line Name** and press **Select**, if **Line Name** is selected scroll ▲ or ▼ to the desired line and press **Select**.

6.3 Save a calls list number to the contact list

1. Press ▼, scroll ▲ or ▼ to highlight the Calls list (**Missed Calls, Received Calls, Outgoing Calls, Accepted Calls, All Call**) you want.
2. Press **Select**, the most recent number (or name if stored in the contact list) is displayed.
3. Scroll ▲ or ▼ to the entry you want and press **Option**.
4. **Save Number** is highlighted, press **Select**.
5. Scroll ▲ or ▼ to select the desired contact list and press **Select**.
6. Scroll ▼ to select the number category you want to store the number under, either **Home, Mobile, or Office** and press **Select**.
7. **First Name** is highlighted, enter the first name and scroll ▼.
8. **Last Name** is highlighted, enter the last name and press **Save**.
9. Press  to return to standby.

6.4 View the details of an entry

1. Press **▼**, scroll **▲** or **▼** to highlight the Calls list (**Missed Calls, Received Calls, Outgoing Calls, Accepted Calls, All Call**) you want.
2. Press **Select**, the most recent number (or name if stored in the contact list) is displayed.
3. Scroll **▲** or **▼** to the entry you want and press **Option**.
4. Scroll **▼** to **View** and press **Select**. The number (and name if stored in the contact list), and the time and date of the call are displayed.
5. Press  to return to standby.



6.5 Delete an entry

1. Press **▼**, scroll **▲** or **▼** to highlight the calls list (**Missed Calls, Received Calls, Outgoing Calls, Accepted Calls, All Call**) you want.
2. Press **Select**, the most recent number (or name if stored in the contact list) is displayed.
3. Scroll **▲** or **▼** to the entry you want and press **Option**.
4. Scroll **▼** to **Delete** and press **Select**. The display shows **Delete?**.
5. Press **Yes** to delete or **No** to cancel.
6. Press  to return to standby.

6.6 Delete all calls list

1. Press **▼**, scroll **▲** or **▼** to highlight the calls list (**Missed Calls, Received Calls, Outgoing Calls, Accepted Calls, All Call**) you want.
2. Press **Select**, the most recent number (or name if stored in the contact list) is displayed.
3. Press **Option**, scroll **▼** to **Delete All** and press **Select**. The display shows **Delete All?**.
4. Press **Yes** to delete or **No** to cancel.
5. Press  to return to standby.

6.7 Predial an entry in the calls list

1. Press **▼**, scroll **▲** or **▼** to highlight the calls list (**Missed Calls, Received Calls, Outgoing Calls, Accepted Calls, All Call**) you want.
2. Press **Select**, the most recent number (or name if stored in the contact list) is displayed.
3. Scroll **▲** or **▼** to the entry you want and press **Option**.
4. Scroll **▼** to **Predial** and press **Select**. The number is displayed.
5. Press  to dial.
If the line selection is set to manual, press  scroll **▲** or **▼** to highlight **Auto** or **Line Name** and press **Select**, if **Line Name** is selected scroll **▲** or **▼** to the desired line and press **Select**.

7. Clock & alarm

The date and time is set automatically when registered to the base. You can change the date and time format to show MM/DD or DD/MM and 12 hours or 24 hours.

Note

The phone can be set so that the base or handset can be the clock master, once set this will sync across all handset. If you have the handset set to clock master as well as changing the format you can set the date and time manually.

7.1 Set the date and time

1. Press **Menu**, scroll **▶** to **Clock & Alarm** and press **Select**.
2. **Date/Time** is highlighted. Press **Select**.
3. To change the date format, scroll **▼** to **Date Format** and scroll **◀** or **▶** to select either **MM/DD** or **DD/MM**.
4. Scroll **▲** to **Enter Date**, enter the date, e.g. when set to MM/DD, 08/27/19 for 27 August 2019 and press **Ok**.
5. Once the date is set, to change the time format, scroll **▼** to **Time Format** and scroll **◀** or **▶** to select either **12 Hours** or **24 Hours**.
6. Scroll **▲** to **Enter Time**, enter the time, e.g. when set to 24 Hours, 1430 for 2:30pm and press **Save**. If the current time format setting is 12 hour, scroll **◀** or **▶** to select **AM** or **PM**.
7. Press **⏪** to return to standby.

7.2 Set the alarm

1. Press **Menu**, scroll **▶** to **Clock & Alarm** and press **Select**.
2. Scroll **▼** to **Alarm** and press **Select**.
3. Activation is highlighted, scroll **◀** or **▶** to **Off**, **Once** or **Daily**.
4. Scroll **▼** to highlight **Enter Time**.
5. Enter the time (HH:MM). If the current time format setting is 12 hour, scroll **◀** or **▶** to select **AM** or **PM**.
6. Scroll **▼** to highlight **Ringtone** **◀** or **▶** to select the desired ringtone and press **Save**.
7. Press **⏪** to return to standby.

Notes

When the alarm sounds,  will flash and the alarm time displays on the screen, press **Off** or **⏪** to stop the ring.

If the alarm is set to **Once**,  will disappear from the screen after the alarm has sounded once.

If the alarm is set to **Daily**,  will remain on the screen after the alarm has sounded.

8. Call settings

8.1 Auto hang-up

The phone is set to end calls by placing the handset on the charger. This feature can be switched off so that calls can only be ended by pressing .

1. Press **Menu**, scroll **▼** to **Call Settings** and press **Select**.
2. **Auto Hang-up** is highlighted. Press **Select**.
3. Scroll **▲** or **▼** to **On** or **Off** and press **Select**.
4. Press  to return to standby.

8.2 Auto answer

The phone is set to answer calls by pressing . If you would rather be able to answer the call by lifting the handset off the charger you will need to turn this feature on.

1. Press **Menu**, scroll **▼** to **Call Settings** and press **Select**.
2. Scroll **▼** to **Auto Answer** and press **Select**.
3. Scroll **▲** or **▼** to **On** or **Off** and press **Select**.
4. Press  to return to standby.

8.3 Add a speed dial number

1. Press **Menu**, scroll **▼** to **Call Settings** and press **Select**.
2. Scroll **▼** to **Speed Dial** and press **Select**.
3. Scroll **▲** or **▼** to select the key where you want to store the number (1-9), press **Select**.
If the entry is empty **No Number** will be displayed, press **Edit**.
4. **Name** is highlighted, enter the name and scroll **▼** to highlight **Number**.
5. Enter the number and press **Save**.
6. Press  to return to standby.

Note

To dial a speed dial number, see page 16.

8.4 Edit / Delete a speed dial number

1. Press **Menu**, scroll ▼ to **Call Settings** and press **Select**.
2. Scroll ▼ to **Speed Dial** and press **Select**.
3. Scroll ▲ or ▼ to select the key where the number is stored, press **Select**.
4. **Name** is highlighted, press **Clear** to delete a character, or press and hold **Clear** to delete all characters. Edit the name if necessary.
5. Scroll ▼ to the number, press **Clear** to delete a digit, or press and hold **Clear** to delete all digits. Edit the number if necessary and press **Save**.
6. Press  to return to standby.

9. Handset settings

9.1 Sound

9.1.1 Ringer volume

The ring volume can be set to different volume levels. Choose from 5 volume levels or Off.

1. Press **Menu**, scroll ▼ to **Handset Settings** and press **Select**.
2. **Sound** is highlighted. Press **Select**.
3. **Ringer Volume** is highlighted. Press **Select**.
4. Scroll ▲ or ▼ to the volume you require and press **Select**.
5. Press  to return to standby.

Note

You can also switch of the ringer off, by pressing and holding  when the handset is in standby

9.1.2 Ringer melody

You can set ringer melodies on your handset. Choose from 10 different melodies. While scrolling a sample ring will be heard for each melody.

1. Press **Menu**, scroll ▼ to **Handset Settings** and press **Select**.
2. **Sound** is highlighted. Press **Select**.
3. Scroll ▼ to **Ringtone** and press **Select**.
4. Scroll ▲ or ▼ to the ringtone you require and press **Select**.
5. Press  to return to standby.

9.1.3 Key beep

When you press a button on the Motorola AXH01 handset, you will hear a beep. You can switch this beep on or off.

1. Press **Menu**, scroll ▼ to **Handset Settings** and press **Select**.
2. **Sound** is highlighted. Press **Select**.
3. Scroll ▼ to **Key Beep** and press **Select**.
4. Scroll ▲ or ▼ to **On** or **Off** and press **Select**.
5. Press  to return to standby.

9.1.4 Out of range tone

When on a call if you move out of range of the base, you will hear a beep. You can switch this tone on or off.

1. Press **Menu**, scroll ▼ to **Handset Settings** and press **Select**.
2. **Sound** is highlighted. Press **Select**.
3. Scroll ▼ to **Out Range Tone** and press **Select**.
4. Scroll ▲ or ▼ to **On** or **Off** and press **Select**.
5. Press  to return to standby.

9.1.5 Cradle tone

When you place the handset on the charger, you will hear a beep. You can switch this beep on or off.

1. Press **Menu**, scroll ▼ to **Handset Settings** and press **Select**.
2. **Sound** is highlighted. Press **Select**.
3. Scroll ▼ to **Cradle Tone** and press **Select**.
4. Scroll ▲ or ▼ to **On** or **Off** and press **Select**.
5. Press  to return to standby.

9.2 Display

9.2.1 Display contrast

You can set the display contrast on the handset screen.

1. Press **Menu**, scroll ▼ to **Handset Settings** and press **Select**.
2. Scroll ▼ to **Display** and press **Select**.
3. **Contrast** is highlighted. Press **Select**.
4. Scroll ▲ or ▼ to the contrast you require and press **Select**.
5. Press  to return to standby.

9.2.2 Wallpaper

Select from 2 different wallpapers for your handset or set to no wallpaper.

1. Press **Menu**, scroll ▼ to **Handset Settings** and press **Select**.
2. Scroll ▼ to **Display** and press **Select**.
3. Scroll ▼ to **Wallpaper** and press **Select**.
4. Scroll ▲ or ▼ to the wallpaper you require and press **Select**.
5. Press  to return to standby.

9.2.3 Display backlight

You can set the amount of time before the backlight turns off.

1. Press **Menu**, scroll ▼ to **Handset Settings** and press **Select**.
2. Scroll ▼ to **Display** and press **Select**.
3. Scroll ▼ to **Backlight Timeout** and press **Select**.
4. Scroll ▲ or ▼ to the time you require and press **Select**.
5. Press  to return to standby.

9.3 Language

1. Press **Menu**, scroll ▼ to **Handset Settings** and press **Select**.
2. Scroll ▼ to **Language** and press **Select**.
3. Scroll ▲ or ▼ to the language you require and press **Select**.
4. Press  to return to standby.

9.4 Registration

On the base:

Press and hold the  button on the base for 5 seconds. You have 120 seconds in which to register a handset.

On the handset:

1. If the handset is not registered to a base, press **Register**. The screen displays **Registering** and once successful **Registered** will be displayed.
2. If the handset is already registered to another base, press **Menu**, scroll ▼ to **Handset Settings** and press **Select**.
3. Scroll ▼ to **Registration** and press **Select**.
4. **Register** is highlighted, press **Select**.
5. The screen displays **Registering** and once successful **Registered** will be displayed.

Note

If the PIN is no longer set to default (0000) then you will be prompted to enter the PIN to register the handset.

A beep will be heard if the registration is successful. The handset is automatically assigned an available handset number.

If registration is not successful the first time, please repeat the process again in case the base registration period ran out of time

If you still cannot register a handset to the base please check how many handsets are already registered. The total number of handsets that can be registered to a base is dependent on the base.

9.5 De-registering a handset

A handset can cancel any handset registered to the same base. This allows the handset to end the wireless connection with the system.

1. Press **Menu**, scroll ▼ to **Handset Settings** and press **Select**.
2. Scroll ▼ to **Registration** and press **Select**.
3. Scroll ▼ to **Unregister** and press **Select**.
4. Enter the PIN and press **Ok**.
5. Scroll ▲ or ▼ to the handset that you want to de-register and press **Select**.
6. The display shows **Unregister?**, press **Yes** to de-register or **No** to cancel.
7. Press  to return to standby.

9.6 Handset name

A personalized name can be set for each handset to easily distinguish between them. A name can be up to 16 characters.

1. Press **Menu**, scroll ▼ to **Handset Settings** and press **Select**.
2. Scroll ▼ to **Handset Name** and press **Select**.
3. The handset name is displayed, press **Clear** to delete a character, or press and hold **Clear** to delete all characters. Enter the new name and press **Save**.
4. Press  to return to standby.

9.7 Restore to default settings

1. Press **Menu**, scroll ▼ to **Handset Settings** and press **Select**.
2. Scroll ▼ to **Handset Setback** and press **Select**.
3. **Confirm?** is displayed, Press **Yes** to confirm or **No** to cancel.
4. Press  to return to standby.

9.8 Handset version

1. Press **Menu**, scroll ▼ to **Handset Settings** and press **Select**.
2. Scroll ▼ to **Handset Version** and press **Select**.
3. The software version will be displayed.
4. Press  to return to standby.

10. Advanced settings

Advanced settings availability are dependent on the CAT-iq base that is being used.

10.1 DECT settings

10.1.1 Change PIN

Some functions are protected by a 4 digit PIN code which must be entered if the settings are changed. The default depends on the base. The PIN can be changed to a preferred number.

When entering a PIN, the digits are shown as ****

1. Press **Menu**, scroll ▼ to **Advanced Settings** and press **Select**.
2. **DECT Settings** is highlighted. Press **Select**.
3. **Change PIN** is highlighted. Press **Select**.
4. Enter the old PIN and press **Ok**.
5. Enter the new PIN and press **Ok**.
6. Re-enter the new PIN and press **Save**.
7. Press  to return to standby.

10.1.2 Clock master

The phone can be set so that the base or handset can be the clock master, once set this will sync across all handset.

1. Press **Menu**, scroll ▼ to **Advanced Settings** and press **Select**.
2. **DECT Settings** is highlighted. Press **Select**.
3. Scroll ▼ to **Clock Master** and press **Select**.
4. Scroll ▲ or ▼ to **Base** or **Handset** and press **Select**.
5. Press  to return to standby.

10.1.3 ECO +

You can set the base ECO + mode via this menu, and the transmission power method depends on the base.

1. Press **Menu**, scroll ▼ to **Advanced Settings** and press **Select**.
2. **DECT Settings** is highlighted. Press **Select**.
3. Scroll ▼ to **ECO +** and press **Select**.
4. Scroll ▲ or ▼ to **De-activate** or **Activate** and press **Select**.
5. Press  to return to standby.

10.1.4 Base version

1. Press **Menu**, scroll ▼ to **Advanced Settings** and press **Select**.
2. **DECT Settings** is highlighted. Press **Select**.
3. Scroll ▼ to **Base Version** and press **Select**.

4. The Firmware, EEPROM and Hardware Versions will be displayed.
5. Press  to return to standby.

10.1.5 Restore to default settings

1. Press **Menu**, scroll **▼** to **Advance Settings** and press **Select**.
2. **DECT Settings** is highlighted. Press **Select**.
3. Scroll **▼** to **Base Setback** and press **Select**.
4. **Confirm?** is displayed, Press **Yes** to confirm or **No** to cancel.
5. Press  to return to standby.

10.2 Internal names

This will show you the list handsets registered to the base.

1. Press **Menu**, scroll **▼** to **Advance Settings** and press **Select**.
2. Scroll **▼** to **Internal Names** and press **Select**.
3. Scroll **▲** or **▼** to the required handset and press **Option**.
Dial - to intercom the selected handset.
Edit - to prevent a call from the selected handset being intercepted, and edit the handset name.
Delete - to unregister the selected handset.
4. Press  to return to standby.

10.3 Line settings

10.3.1 Line name

If you have multiple lines, each line can have a different name.

1. Press **Menu**, scroll **▼** to **Advance Settings** and press **Select**.
2. Scroll **▼** to **Line Settings** and press **Select**.
3. Enter the PIN and press **Ok**.
4. Scroll **▲** or **▼** to the required line and press **Option**.
5. **Line Name** is highlighted, press **Select**.
6. The line name is displayed, press **Clear** to delete a character, or press and hold **Clear** to delete all characters. Enter the new name and press **Save**.
7. Press  to return to standby.

10.3.2 Line ID

1. Press **Menu**, scroll **▼** to **Advance Settings** and press **Select**.
2. Scroll **▼** to **Line Settings** and press **Select**.
3. Enter the PIN and press **Ok**.
4. Scroll **▲** or **▼** to the required line and press **Option**.
5. Scroll **▼** to **Line ID** and press **Select**.
6. The line ID is displayed.

7. Press  to return to standby.

10.4 Line selection

When making calls you can pre set the line selection to auto, manual or individual line selection.

1. Press **Menu**, scroll **▼** to **Advance Settings** and press **Select**.
2. Scroll **▼** to **Line Selection** and press **Select**.
3. Scroll **▲** or **▼** to select **Manual**, **Auto** or the desired named line and press **Select**.
4. Press  to return to standby.

10.5 Default settings

Contact list	Unchanged
Ring volume	3
Ring tones	1
Key tone	On
Out of range tone	Off
Cradle tone	On
Handset name	Supplied by the base
Date & time	01-01-2016, 12:00
Auto answer	Off
Auto hang-up	On
Alarm	Off
Caller list	base dependent
Redial list	base dependent
Receiver/speaker volume	3
Line selection	Auto
Speed dial	Unchanged

11. Technical Specifications

RF frequency band	1921.536 - 1928.448MHz
Channels	5
Operation temperature	10 - 40°C
Base voltage (AC voltage, 50Hz/60Hz)	100V - 230V AC
Base voltage (Adaptor output)	5VDC/1A
Handset voltage	750mAh 1.2Vx2 AAA Ni-MH battery
Charger voltage (Adaptor output)	6VDC/0.4A

12. Help

Unable to open the Alexa App

- Force close the app.
- Restart your cell phone.
- Uninstall and reinstall the app.
- For further help you can go to Apple or Google support.
iOS - <https://getsupport.apple.com/>
Android - <https://support.google.com/android/>

No dial tone

- Use only the telephone line cord supplied.
- Check that the telephone line cord is connected properly.
- Check that the AC power is connected properly and switched on.

No display

- Check that the batteries are inserted correctly and fully charged. Use only approved rechargeable batteries supplied.
- Check that the handset is switched on. Press and hold .
- Reset the unit by removing the batteries and disconnecting the AC power. Wait for around 15 seconds before connecting it again. Allow up to one minute for the handset and base to synchronize.

LCD does not light up during operation

- Battery charge is low. Fully charge the batteries.

Signal icon is not white

- Handset is out of range. Move closer to the base.
- Check that the AC power is connected properly.

Keypad does not seem to work

- Check that the keypad lock is not on.

Battery icon is not scrolling during charge

- Adjust the handset slightly on the charger.
- Clean the charging contacts with a cloth moistened with alcohol.
- Check that the charger power is connected properly.
- The battery is full. The battery icon will appear steady on the display.

No Caller Display

- Check with your network operator.
- The caller may have withheld their number.

Caller Display doesn't show the name of the caller

- The record cannot be found in the contact list.
- Check that the correct name/number is stored in the contact list, with the full area code.

Cannot register a handset to the base

- The number of handsets that can be registered is dependent on the base. Check that correct PIN code (default is dependent on the base) has been entered.

Handset does not ring

- The handset ringer volume may be set to Off.
- Check the handset is saved as an attached handset for the line being called.

Noise interference on my phone or on other electrical equipment nearby

- Place the phone at least one meter away from electrical appliances or any metal obstructions to avoid any risk of interference.

13. General information

Important

This equipment is not designed to make emergency telephone calls when the power fails. Alternative arrangements should be made for access to emergency services.

This product is intended for connection to analogue public switched telephone networks and private switchboards in the US.

Important safety instructions

Follow these safety precautions when using your phone to reduce the risk of fire, electric shock, and injury to persons or property:

- Keep all slits and openings of the phone unblocked. Do not set the phone on a heating register or over a radiator. Ensure that proper ventilation is provided at the installation site.
- Do not use while wet or while standing in water.
- Do not use this product near water (for example, near a bath tub, kitchen sink, or swimming pool).
- Do not allow anything to rest on the power cord. Place the power cord so that it will not be walked on.
- Never insert objects of any kind into the product vents as that may result in fire or electric shock.
- Unplug this product from the wall outlet before cleaning. Do not use liquid cleaners or aerosol cleaners. Use a damp cloth for cleaning.
- Do not disassemble this product. If service or repair work is required, contact the customer service helpline found in this user's Guide.
- Do not overload wall outlets and extension cords.
- Avoid using during an electrical storm. Use a surge protector to protect the equipment.
- Do not use this phone to report a gas leak, especially if you are in the vicinity of the gas line.

Important

To reduce the risk of fire, use only the supplied AC power adaptor.

Unplug this phone immediately from an outlet if:

- The power cord or plug is damaged or frayed.
- Liquid has been spilled on the product.
- The product has been exposed to rain or water. Do not retrieve the base or charger until after you have unplugged the power the wall. Then retrieve the unit by the unplugged cords.
- The product has been dropped or the cabinet has been damaged.
- The product exhibits a distinct change in performance.

Installation Guidelines

- Read and understand all instructions and save them for future reference.
- Follow all warnings and instructions marked on the product.
- Do not install this product near a bath tub, sink, or shower.
- Operate this phone using only the power source that is indicated on the marking label. If you are unsure of the power supply to your home, consult with your dealer or local power company.
- Do not place this product on an unstable cart, stand, or table. This product may fall, causing serious damage to the product.
- Adjust only those controls that are covered by the operating instructions. Improper adjustment of other controls may result in damage and will often require extensive work to restore the product to normal operation.
- Clean this product with a soft, damp cloth. Do not use chemicals or cleaning agents to clean this phone.
- Use only the power supply that came with this unit. Using other power supplies may damage the unit.

Battery Safety Instructions

- Do not burn, disassemble, mutilate, or puncture the battery. The battery contains toxic materials that could be released, resulting in injury.

Important

There is a risk of explosion if you replace the battery with an incorrect battery type. Use only the batteries that came with your phone or an authorized replacement recommended by the manufacturer.

- Keep batteries out of the reach of children.
- Remove batteries if storing over 30 days.
- Do not dispose of batteries in fire, which could result in explosion.
- The rechargeable batteries that power this product must be disposed of properly and may need to be recycled. Refer to your battery's label for battery type. Contact your local recycling center for proper disposal methods.

Save these instructions

Cleaning

- Clean the phone with a damp (not wet) cloth, or an anti-static wipe.
- Never use household polish as this will damage the product. Never use a dry cloth as this may cause static shock.

Environmental

- Do not expose to direct sunlight.
- The phone may become warm when the batteries are being charged or during prolonged periods of use. This is normal. However, we recommend that to avoid damage, do not place the product on antique / veneered wood.
- Do not place your product on carpets or other surfaces which generate fibres, or place it in locations preventing the free flow of air over its surfaces.
- Do not submerge any part of your product in water and do not use it in damp or humid conditions, such as bathrooms.
- Do not expose your product to fire, explosives or other hazardous conditions.
- There is a slight chance that your phone could be damaged by an electrical storm. We recommend that you unplug the power cord during an electrical storm.

Product disposal instructions

Product disposal instructions for residential users

When you have no further use for it, please remove any batteries and dispose of them and the product according to your local authority's recycling processes. For more information, please contact your local authority or the retailer where the product was purchased.

Product disposal instructions for business users

Business users should contact their suppliers and check the terms and conditions of the purchase contract and ensure that this product is not mixed with other commercial waste for disposal.

Consumer Products and Accessories Warranty

Thank you for purchasing this Motorola branded product manufactured under license by Meizhou Guo Wei Electronics Co. Ltd., AD1 section, Economic Development Area, Dongsheng Industrial District, Meizhou, Guangdong, China. ("MZGW")

What Does this Warranty Cover?

Subject to the exclusions contained below, MZGW warrants that this Motorola branded product ("Product") or certified accessory ("Accessory") sold for use with this product that it manufactured to be free from defects in materials and workmanship under normal consumer usage for the period outlined below. This Limited Warranty is your exclusive warranty and is not transferable.

Who is covered?

This warranty extends only to the first consumer purchaser, and is not transferable.

What will MZGW do?

MZGW or its authorized distributor at its option and within a commercially reasonable time, will at no charge repair or replace any Products or Accessories that do not conform to this limited warranty. We may use functionally equivalent reconditioned / refurbished / pre-owned or new Products, Accessories or parts.

What Other Limitations Are There?

ANY IMPLIED WARRANTIES, INCLUDING WITHOUT LIMITATION THE IMPLIED WARRANTIES OF MERCHANTABILITY AND FITNESS FOR A PARTICULAR PURPOSE, SHALL BE LIMITED TO THE DURATION OF THIS LIMITED WARRANTY, OTHERWISE THE REPAIR OR REPLACEMENT PROVIDED UNDER THIS EXPRESS LIMITED WARRANTY IS THE EXCLUSIVE REMEDY OF THE CONSUMER, AND IS PROVIDED IN LIEU OF ALL OTHER WARRANTIES, EXPRESS OR IMPLIED. IN NO EVENT SHALL MOTOROLA OR MZGW BE LIABLE, WHETHER IN CONTRACT OR TORT (INCLUDING NEGLIGENCE) FOR DAMAGES IN EXCESS OF THE PURCHASE PRICE OF THE PRODUCT OR ACCESSORY, OR FOR ANY INDIRECT, INCIDENTAL, SPECIAL OR CONSEQUENTIAL DAMAGES OF ANY KIND, OR LOSS OF REVENUE OR PROFITS, LOSS OF BUSINESS, LOSS OF INFORMATION OR OTHER FINANCIAL LOSS ARISING OUT OF OR IN CONNECTION WITH THE ABILITY OR INABILITY TO USE THE PRODUCTS OR ACCESSORIES TO THE FULL EXTENT THESE DAMAGES MAY BE DISCLAIMED BY LAW.

Some jurisdictions do not allow the limitation or exclusion of incidental or consequential damages, or limitation on the length of an implied warranty, so the above limitations or exclusions may not apply to you. This warranty gives you specific legal rights, and you may also have other rights that vary from one jurisdiction to another.

Products Covered	Length of Coverage
Consumer Products	One (1) year from the date of the products original purchase by the first consumer purchaser of the product.
Consumer Accessories (battery, power supply(s) and line cords)	Ninety (90) days from the date of the accessories original purchase by the first consumer purchaser of the product.
Consumer Products and Accessories that are Repaired or Replaced	The balance of the original warranty or for ninety (90) days from the date returned to the consumer, whichever is longer.

Exclusions

Normal Wear and Tear. Periodic maintenance, repair and replacement of parts due to normal wear and tear are excluded from coverage.

Batteries. Only batteries whose fully charged capacity falls below 80% of their rated capacity and batteries that leak are covered by this limited warranty.

Abuse & Misuse. Defects or damage that result from: (a) improper operation, storage, misuse or abuse, accident or neglect, such as physical damage (cracks, scratches, etc.) to the surface of the product resulting from misuse; (b) contact with liquid, water, rain, extreme humidity or heavy perspiration, sand, dirt or the like, extreme heat, or food; (c) use of the Products or Accessories for commercial purposes or subjecting the Product or Accessory to abnormal usage or conditions; or (d) other acts which are not the fault of Motorola or MZGW are excluded from coverage.

Use of Non-Motorola branded Products and Accessories. Defects or damage that result from the use of Non-Motorola branded or certified Products or Accessories or other peripheral equipment are excluded from coverage.

Unauthorized Service or Modification. Defects or damages resulting from service, testing, adjustment, installation, maintenance, alteration, or modification in any way by someone other than Motorola, MZGW or its authorized service centers, are excluded from coverage.

Altered Products. Products or Accessories with (a) serial numbers or date tags that have been removed, altered or obliterated; (b) broken seals or that show evidence of tampering; (c) mismatched board serial numbers; or (d) nonconforming or non-Motorola branded housings, or parts, are excluded from coverage.

Communication Services. Defects, damages, or the failure of Products or Accessories due to any communication service or signal you may subscribe to or use with the Products or Accessories is excluded from coverage.

How to Obtain Warranty Service or Other Information?

To obtain service or information, please call: xxxxxxxxxx.

You will receive instructions on how to ship the Products or Accessories at your expense and risk, to a MZGW Authorized Repair Center.

To obtain service, you must include: (a) the Product or Accessory; (b) the original proof of purchase (receipt) which includes the date, place and seller of the Product; (c) if a warranty card was included in your box, a completed warranty card showing the serial number of the Product; (d) a written description of the problem; and, most importantly; (e) your address and telephone number.

FCC, ACTA and IC regulations

FCC Part 15

This equipment has been tested and found to comply with the requirements for a Class B digital device under Part 15 of the Federal Communications Commission (FCC) rules. These requirements are intended to provide reasonable protection against harmful interference in a residential installation. This equipment generates, uses and can radiate radio frequency energy and, if not installed and used in accordance with the instructions, may cause harmful interference to radio communications. However, there is no guarantee that interference will not occur in a particular installation. If this equipment does cause harmful interference to radio or television reception, which can be determined by turning the equipment off and on, the user is encouraged to try to correct the interference by one or more of the following measures:

- Reorient or relocate the receiving antenna.
- Increase the separation between the equipment and receiver.
- Connect the equipment into an outlet on a circuit different from that to which the receiver is connected.
- Consult the dealer or an experienced radio/TV technician for help.

Changes or modifications to this equipment not expressly approved by the party responsible for compliance could void the user's authority to operate the equipment.

This device complies with Part 15 of the FCC rules. Operation is subject to the following two conditions: (1) this device may not cause harmful interference, and (2) this device must accept any interference received, including interference that may cause undesired operation. Privacy of communications may not be ensured when using this telephone.

This Class B digital apparatus complies with Canadian ICES-003.

This device complies with Industry Canada licence-exempt RSS standard(s). Operation is subject to the following two conditions: (1) this device may not cause interference, and (2) this device must accept any interference, including interference that may cause undesired operation of the device.

FCC Part 68 and ACTA

This equipment complies with Part 68 of the FCC rules and with technical requirements adopted by the Administrative Council for Terminal Attachments (ACTA). This Product Complies With 47CFR PART 68.

The plug and jack used to connect this equipment to premises wiring and the telephone network must comply with applicable Part 68 rules and technical requirements adopted by ACTA. A compliant telephone cord and modular plug is provided with this product. It is designed to be connected to a compatible modular jack that is also compliant. An RJ11 jack should normally be used for connecting to a single line and an RJ14 jack for two lines. See Installation Instructions in the User's Guide.

The Ringer Equivalence Number (REN) is used to determine how many devices you may connect to your telephone line and still have them ring when you are called. The REN for this product is encoded as the 6th and 7th characters following the US: in the product identifier (e.g., if ## is 03, the REN is 0.3). In most, but not all areas, the sum of all RENs should be five (5.0) or less. For more information, please contact your local telephone company.

This equipment may not be used with Party Lines. If you have specially wired alarm dialing equipment connected to your telephone line, ensure the connection of this equipment does not disable your alarm equipment. If you have questions about what will disable alarm equipment, consult your telephone company or a qualified installer.

If this equipment is malfunctioning, it must be unplugged from the modular jack until the problem has been corrected. Repairs to this telephone equipment can only be made by the manufacturer or its authorized agents. For repair procedures, follow the instructions outlined under the Limited Warranty.

If this equipment is causing harm to the telephone network, the telephone company may temporarily discontinue your telephone service. The telephone company is required to notify you before interrupting service. If advance notice is not practical, you will be notified as soon as possible. You will be given the opportunity to correct the problem and the telephone company is required to inform you of your right to file a complaint with the FCC. Your telephone company may make changes in its facilities, equipment, operation, or procedures that could affect the proper functioning of this product. The telephone company is required to notify you if such changes are planned.

If this product is equipped with a corded or cordless handset, it is hearing aid compatible. If this product has memory dialing locations, you may choose to store emergency telephone numbers (e.g., police, fire, medical) in these locations. If you do store or test emergency numbers, please:

- Remain on the line and briefly explain the reason for the call before hanging up.
- Perform such activities in off-peak hours, such as early morning or late evening.

Industry Canada

Operation is subject to the following two conditions: (1) this device may not cause harmful interference, and (2) this device must accept any interference, including interference that may cause undesired operation.

The term "IC: " before the certification/registration number only signifies that the Industry Canada technical specifications were met.

The Ringer Equivalence Number (REN) for this terminal equipment is 0.0B. The REN is an indication of the maximum number of devices allowed to be connected to a telephone interface. The termination on an interface may consist of any combination of devices subject only to the requirement that the sum of the RENs of all the devices does not exceed five.

This equipment meets the applicable Industry Canada Terminal Equipment & Technical Specifications.

Placing the receiver slightly above the ear may result in better performance for hearing aids with microphones positioned behind the ear.

FCC Exposure to Radio Frequency (RF) Signals

For Handset

This is a radio transmitter and receiver. It is designed and manufactured not to exceed the emission limits for exposure to radio frequency (RF) energy set by the Federal Communications Commission (FCC) of the U.S. Government. These limits are part of comprehensive guidelines and establish permitted levels of RF energy for the general population. The guidelines are based on the safety standards previously set by both U.S. and international standards bodies. These standards include a substantial safety margin designed to assure the safety of all persons, regardless of age and health. This device and its antenna must not be co-located or operating in conjunction with any other antenna or transmitter. This product has been shown to be capable of compliance for localized specific absorption rate (SAR) for uncontrolled environment/general population exposure limits specified in ANSI/IEEE Std. C95.1-1992 and had been tested in accordance with the measurement procedures specified in FCC/OET Bulletin 65 Supplement C (2001) and IEEE 1528.

For Base

This equipment complies with FCC radiation exposure limits set forth for an uncontrolled environment. This equipment should be installed and operated with minimum distance 20cm between the radiator & your body.

This transmitter must not be co-located or operating in conjunction with any other antenna or transmitter.

14. Wall mounting

Important

Before you wall mount your AXH base, check that you are not drilling into any hidden wiring or pipes.

Before you drill, make sure all the cables will reach the router, telephone socket and AC outlet.

1. Use the following templates to mark the drilling locations.

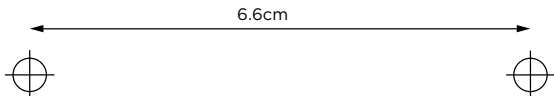

- To wall-mount the base, drill two holes in the wall 6.6cm apart horizontally using a 5mm drill bit.

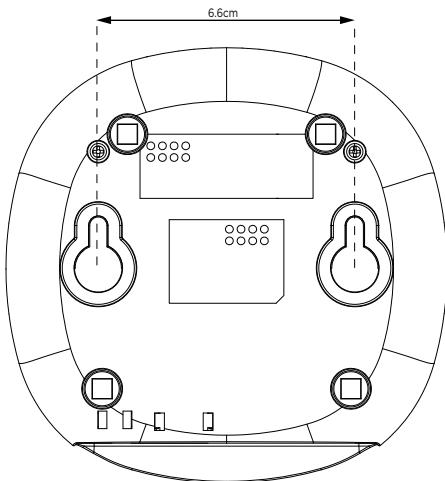

-
2. Insert the wall plugs if necessary, then insert the screws leaving about 5mm protruding from the wall on which to hang the phone.
3. Slot the holes on the back of the base over the screw heads and gently pull the base/charger down to make sure it is securely in place.

Importers Address

Manufactured, distributed or sold by Meizhou Guo Wei Electronics Co. LTD., official licensee for this product. MOTOROLA and the Stylized M Logo are trademarks or registered trademarks of Motorola Trademark Holdings, LLC. and are used under license. All other trademarks are the property of their respective owners. © 2018 Motorola Mobility LLC. All rights reserved.

Version Draft.3 (EN_US)

