



TEST REPORT

FCC Part 27

Report Reference No. : CTL1909294033-WF05

Compiled by: Happy Guo
(position+printed name+signature) (File administrators)

Happy Guo

Tested by: Nice Nong
(position+printed name+signature) (Test Engineer)

Nice Nong

Approved by: Ivan Xie
(position+printed name+signature) (Manager)

Ivan Xie

Product Name : Sentek IoT

Model/Type reference : Sentek Modem SM200 V1.3

List Model(s)..... : N/A

Trade Mark..... : N/A

FCC ID..... : 2ARQB-SM200

Applicant's name : Sentek Pty Ltd

Address of applicant : 77 Magill Road, Stepney 5069, South Australia, Australia

Test Firm..... : Shenzhen CTL Testing Technology Co., Ltd.

Address of Test Firm : Floor 1-A, Baisha Technology Park, No.3011, Shahexi Road, Nanshan District, Shenzhen, China 518055

Test specification..... :

Standard : FCC CFR Title 47 Part 2, Part 27
ANSI/TIA/EIA-603-E:2016
KDB 971168 D01

TRF Originator : Shenzhen CTL Testing Technology Co., Ltd.

Master TRF..... : Dated 2011-01

Date of receipt of test item : Mar. 05, 2020

Date of sampling..... : Mar. 05, 2020

Date of Test Date..... : Mar. 05, 2020–May 15, 2020

Date of Issue : Sep. 02, 2020

Result..... : Pass

Shenzhen CTL Testing Technology Co., Ltd. All rights reserved.

This publication may be reproduced in whole or in part for non-commercial purposes as long as the Shenzhen CTL Testing Technology Co., Ltd. is acknowledged as copyright owner and source of the material. Shenzhen CTL Testing Technology Co., Ltd. takes no responsibility for and will not assume liability for damages resulting from the reader's interpretation of the reproduced material due to its placement and context.

TEST REPORT

Test Report No. : CTL1909294033-WF05	Sep. 02, 2020
	Date of issue

Equipment under Test : Sentek IoT

Model /Type : Sentek Modem SM200 V1.3

Listed Models : N/A

Applicant : **Sentek Pty Ltd**

Address : 77 Magill Road, Stepney 5069, South Australia, Australia

Manufacturer : **Sentek Pty Ltd**

Address : 77 Magill Road, Stepney 5069, South Australia, Australia

Test result	Pass *
--------------------	---------------

*In the configuration tested, the EUT complied with the standards specified page 5.

The test results presented in this report relate only to the object tested.

This report shall not be reproduced, except in full, without the written approval of the issuing testing laboratory.

Table of Contents

Page

1. SUMMARY	5
1.1. TEST STANDARDS.....	5
1.2. TEST DESCRIPTION.....	5
1.3. TEST FACILITY	6
1.4. STATEMENT OF THE MEASUREMENT UNCERTAINTY.....	6
2. GENERAL INFORMATION	7
2.1. ENVIRONMENTAL CONDITIONS	7
2.2. GENERAL DESCRIPTION OF EUT	7
2.3. DESCRIPTION OF TEST MODES	7
2.4. EQUIPMENTS USED DURING THE TEST	8
2.5. RELATED SUBMITTAL(S) / GRANT (S).....	8
2.6. MODIFICATIONS.....	8
3. TEST CONDITIONS AND RESULTS	9
3.1. OUTPUT POWER	9
3.2. SPURIOUS EMISSION.....	13
4. TEST SETUP PHOTOS OF THE EUT.....	16
5. PHOTOS OF THE EUT.....	17

1. SUMMARY

1.1. TEST STANDARDS

The tests were performed according to following standards:

[FCC Part 27](#) : MISCELLANEOUS WIRELESS COMMUNICATIONS SERVICES

[ANSI/TIA/EIA-603-E March 2016](#): Land Mobile FM or PM Communications Equipment Measurement and Performance Standards.

[FCC Part 2](#): FREQUENCY ALLOCATIONS AND RADIO TREATY MATTERS; GENERAL RULES AND REGULATIONS

[KDB971168 D01: v02r02](#) MEASUREMENT GUIDANCE FOR CERTIFICATION OF LICENSED DIGITAL TRANSMITTERS

[ANSI C63.10: 2013](#): American National Standard for Testing Unlicensed Wireless Devices

[ANSI C63.4: 2014](#): –American National Standard for Methods of Measurement of Radio-Noise Emissions from Low-Voltage Electrical and Electronic Equipment in the Range of 9 kHz to 40GHz
Range of 9 kHz to 40GHz

1.2. Test Description

Test Item	Section in CFR 47	Result
RF Output Power	Part 2.1046 Part 27.50(d)(4)	Pass
Spurious Emission	Part 2.1053 Part 27.53(h)	Pass

1.3. Test Facility

1.3.1 Address of the test laboratory

Shenzhen CTL Testing Technology Co., Ltd.

Floor 1-A, Baisha Technology Park, No. 3011, Shahehexi Road, Nanshan, Shenzhen 518055 China

There is one 3m semi-anechoic chamber and two line conducted labs for final test. The Test Sites meet the requirements in documents ANSI C63.4 and CISPR 32/EN 55032 requirements.

1.3.2 Laboratory accreditation

The test facility is recognized, certified, or accredited by the following organizations:

CNAS-Lab Code: L7497

Shenzhen CTL Testing Technology Co., Ltd. has been assessed and proved to be in compliance with CNAS-CL01 Accreditation Criteria for Testing and Calibration Laboratories (identical to ISO/IEC 17025: 2005 General Requirements) for the Competence of Testing and Calibration Laboratories.

A2LA-Lab Cert. No. 4343.01

Shenzhen CTL Testing Technology Co., Ltd, EMC Laboratory has been accredited by A2LA for technical competence in the field of electrical testing, and proved to be in compliance with ISO/IEC 17025: 2005 General Requirements for the Competence of Testing and Calibration Laboratories and any additional program requirements in the identified field of testing.

IC Registration No.: 9618B

CAB identifier: CN0041

The 3m alternate test site of Shenzhen CTL Testing Technology Co., Ltd. EMC Laboratory has been registered by Innovation, Science and Economic Development Canada to test to Canadian radio equipment requirements with Registration No.: 9618B on Jan. 22, 2019.

FCC-Registration No.: 399832

Designation No.: CN1216

Shenzhen CTL Testing Technology Co., Ltd. EMC Laboratory has been registered and fully described in a report filed with the (FCC) Federal Communications Commission. The acceptance letter from the FCC is maintained in our files. Registration 399832, December 08, 2017.

1.4. Statement of the measurement uncertainty

The data and results referenced in this document are true and accurate. The reader is cautioned that there may be errors within the calibration limits of the equipment and facilities. The measurement uncertainty was calculated for all measurements listed in this test report acc. to CISPR 16 - 4 "Specification for radio disturbance and immunity measuring apparatus and methods – Part 4: Uncertainty in EMC Measurements" and is documented in the Shenzhen CTL Testing Technology Co., Ltd. quality system acc. to DIN EN ISO/IEC 17025. Furthermore, component and process variability of devices similar to that tested may result in additional deviation. The manufacturer has the sole responsibility of continued compliance of the device.

Hereafter the best measurement capability for CTL laboratory is reported:

Test	Range	Measurement Uncertainty	Notes
Radiated Emission	30~1000MHz	4.10dB	(1)
Radiated Emission	Above 1GHz	4.32dB	(1)
Conducted Disturbance	0.15~30MHz	3.20dB	(1)

(1) This uncertainty represents an expanded uncertainty expressed at approximately the 95% confidence level using a coverage factor of k=2.

2. GENERAL INFORMATION

2.1. Environmental conditions

During the measurement the environmental conditions were within the listed ranges:

Normal Temperature:	25°C
Relative Humidity:	55 %
Air Pressure:	101 kPa

2.2. General Description of EUT

Product Name:	Sentek IoT		
Model/Type reference:	Sentek Modem SM200 V1.3		
Power supply:	DC 11.1V from battery		
Hardware version:	V1.0		
Software version:	V1.0		
LTE band 13			
Operation Band:	band 13		
Modulation Type:	Cat-M1	QPSK, 16QAM	
Frequency range:	LTE band 13(Channel Bandwidth:5MHz)	779.5~784.5MHz	
Max. ERP power	230.67mW		
Emission Designator	1M09G7D		
Antenna Type:	External antenna		
Antenna Gain:	4 dBi		

Note: For more details, refer to the user's manual of the EUT.

2.3. Description of Test Modes

Pre-Scan has been conducted to determine the worst-case mode from all possible combinations between available modulations, data rates, XYZ axis.

The worst-case was found when positioned as the table below, Following channel(s) was(were) selected for the final test as listed below.

Band	ERP	Radiated Emission
LTE band 13	Z-plane	Z-plane

Test Item	Available channel	Test channel	Channel Bandwidth	Modulation	Mode
ERP	779.5~784.5MHz	23205(779.5MHz), 23230(782.0MHz), 23255(784.5MHz)	5MHz	QPSK, 16QAM	1 RB/0 RB Offset
Radiated Emission	779.5~784.5MHz	23205(779.5MHz), 23230(782.0MHz), 23255(784.5MHz)	5MHz	QPSK	1 RB/0 RB Offset

Note: This device was tested under all RB configurations and modulations. The worst case was found in QPSK modulation.

2.4. Equipments Used during the Test

Test Equipment	Manufacturer	Model No.	Serial No.	Calibration Date	Calibration Due Date
Bilog Antenna	Sunol Sciences Corp.	JB1	A061713	2019/05/20	2020/05/19
Bilog Antenna	Sunol Sciences Corp.	JB1	A061714	2019/05/20	2020/05/19
EMI Test Receiver	R&S	ESCI	103710	2019/05/20	2020/05/19
Spectrum Analyzer	Agilent	E4407B	MY41440676	2019/05/20	2020/05/19
Spectrum Analyzer	Agilent	N9020	US46220290	2019/05/20	2020/05/19
EXA Signal Analyzer	Keysight	N9010B	MY57110481	2019/05/20	2020/05/19
Controller	EM Electronics	Controller EM 1000	N/A	2019/05/20	2020/05/19
Horn Antenna	Sunol Sciences Corp.	DRH-118	A062013	2019/05/20	2020/05/19
Horn Antenna	Sunol Sciences Corp.	DRH-118	A062014	2019/05/20	2020/05/19
Active Loop Antenna	SCHWARZBEC K	FMZB1519	1519-037	2019/05/20	2020/05/19
Amplifier	Agilent	8449B	3008A02306	2019/05/20	2020/05/19
Amplifier	Agilent	8447D	2944A10176	2019/05/20	2020/05/19
Temperature/Humidity Meter	Gangxing	CTH-608	02	2019/05/20	2020/05/19
Wideband Radio Communication Tester	R&S	CMW500	101814	2019/05/20	2020/05/19
High-Pass Filter	K&L	9SH10-2700/X1 2750-O/O	N/A	2019/05/20	2020/05/19
High-Pass Filter	K&L	41H10-1375/U1 2750-O/O	N/A	2019/05/20	2020/05/19
RF Cable	HUBER+SUHN ER	RG214	N/A	2019/05/20	2020/05/19
Climate Chamber	ESPEC	EL-10KA	A20120523	2019/05/20	2020/05/19
SIGNAL GENERATOR	Agilent	E4421B	US40051744	2019/05/20	2020/05/19
Directional Coupler	Agilent	87300B	3116A03638	2019/05/20	2020/05/19

The calibration interval was one year

2.5. Related Submittal(s) / Grant (s)

This submittal(s) (test report) is intended to comply with of the Part 27.

2.6. Modifications

No modifications were implemented to meet testing criteria.

3. TEST CONDITIONS AND RESULTS

3.1. Output Power

LIMIT

3 watts ERP.

TEST CONFIGURATION

Conducted Power Measurement

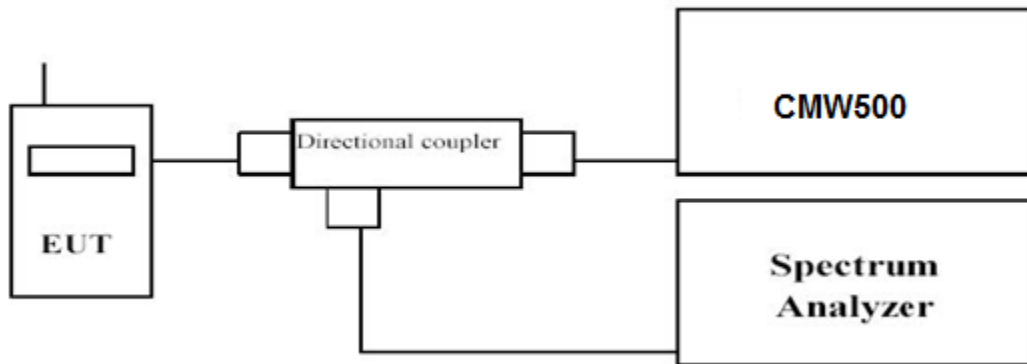

Radiated Power Measurement:

(A) Radiated Emission Test Set-Up, Frequency Below 30MHz

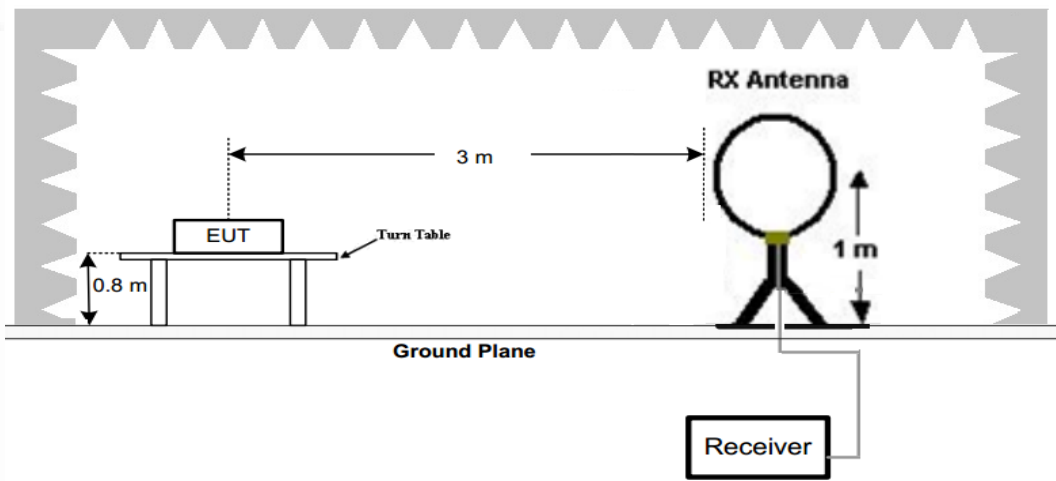

(B) Radiated Emission Test Set-Up, Frequency below 1000MHz

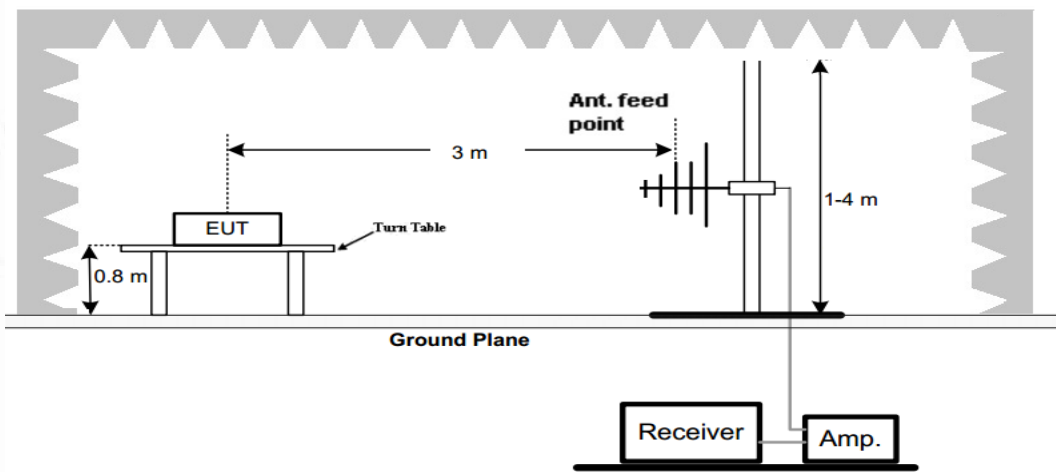

(C) Radiated Emission Test Set-Up, Frequency above 1000MHz

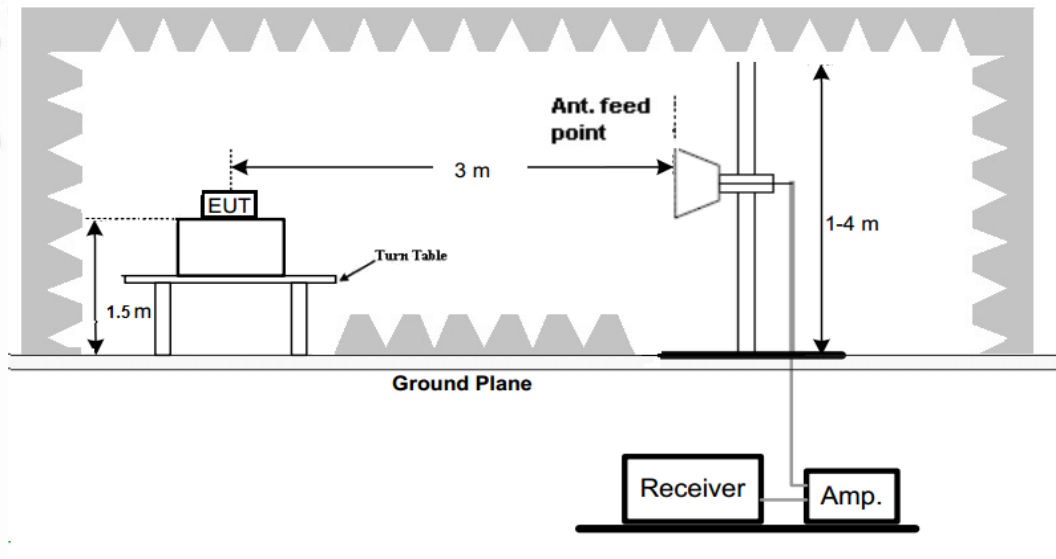

TEST PROCEDURE

The EUT was setup according to ANSI/TIA/EIA-603-E

Conducted Power Measurement:

- a) Place the EUT on a bench and set it in transmitting mode.
- b) Connect a low loss RF cable from the antenna port to a spectrum analyzer and CMW500 by a Directional Couple.
- c) EUT Communicate with CMW500 then selects a channel for testing.
- d) Add a correction factor to the display of spectrum, and then test.

Radiated Power Measurement:

- a) The EUT shall be placed at the specified height on a support, and in the position closest to normal use as declared by provider.
- b) The test antenna shall be oriented initially for vertical polarization and shall be chosen to correspond to the frequency of the transmitter
- c) The output of the test antenna shall be connected to the measuring receiver.
- d) The transmitter shall be switched on and the measuring receiver shall be tuned to the frequency of the transmitter under test.
- e) The test antenna shall be raised and lowered through the specified range of height until a maximum signal level is detected by the measuring receiver.
- f) The transmitter shall then be rotated through 360° in the horizontal plane, until the maximum signal level is detected by the measuring receiver.
- g) The test antenna shall be raised and lowered again through the specified range of height until a maximum signal level is detected by the measuring receiver.
- h) The maximum signal level detected by the measuring receiver shall be noted.
- i) The transmitter shall be replaced by a substitution antenna.
- j) The substitution antenna shall be orientated for vertical polarization and the length of the substitution antenna shall be adjusted to correspond to the frequency of the transmitter.
- k) The substitution antenna shall be connected to a calibrated signal generator.

- l) If necessary, the input attenuator setting of the measuring receiver shall be adjusted in order to increase the sensitivity of the measuring receiver.
- m) The test antenna shall be raised and lowered through the specified range of height to ensure that the maximum signal is received.
- n) The input signal to the substitution antenna shall be adjusted to the level that produces a level detected by the measuring receiver, that is equal to the level noted while the transmitter radiated power was measured, corrected for the change of input attenuator setting of the measuring receiver.
- o) The measurement shall be repeated with the test antenna and the substitution antenna orientated for horizontal polarization.
- p) The measure of the effective radiated power is the larger of the two levels recorded at the input to the substitution antenna, corrected for gain of the substitution antenna if necessary.
- q) Test site anechoic chamber refer to ANSI C63.4.

TEST RESULTS**Radiated Measurement:**

Channel Bandwidth 5MHz/QPSK							
Plane	Channel	Frequency (MHz)	Reading (dBm)	Correction Factor(dB)	ERP (dBm)	ERP (mW)	Polarization (H/V)
Z	23205	779.5	-0.95	20.67	17.57	57.15	H
	23230	782.0	-1.15	20.67	17.37	54.58	
	23255	784.5	-1.92	20.68	16.61	45.81	
	23205	779.5	5.11	20.67	23.63	230.67	V
	23230	782.0	4.49	20.67	23.01	199.99	
	23255	784.5	4.60	20.68	23.13	205.59	
Channel Bandwidth 5MHz/16QAM							
Z	23205	779.5	-1.99	20.67	16.53	44.98	H
	23230	782.0	-2.02	20.67	16.50	44.67	
	23255	784.5	-2.39	20.68	16.14	41.11	
	23205	779.5	4.59	20.67	23.11	204.64	V
	23230	782.0	4.27	20.67	22.79	190.11	
	23255	784.5	3.82	20.68	22.35	171.79	

Note: ERP(dBm)= Reading(dBm)+ Correction Factor(dB)-2.15

3.2. Spurious Emission

LIMIT

According to §27.53 (h): For operations in the 1710–1755 MHz and 2110–2155 MHz bands, the power of any emission outside a licensee's frequency block shall be attenuated below the transmitter power (P) by at least $43 + 10 \log_{10}(P)$ dB.

TEST CONFIGURATION

Conducted Spurious Measurement:

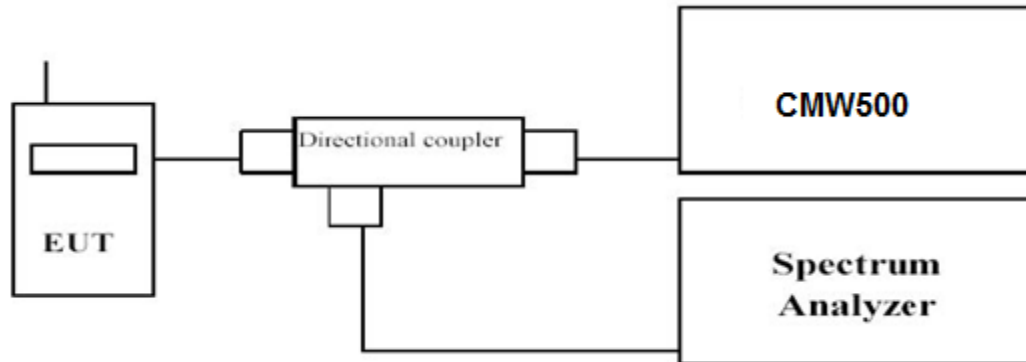

Radiated Spurious Measurement:

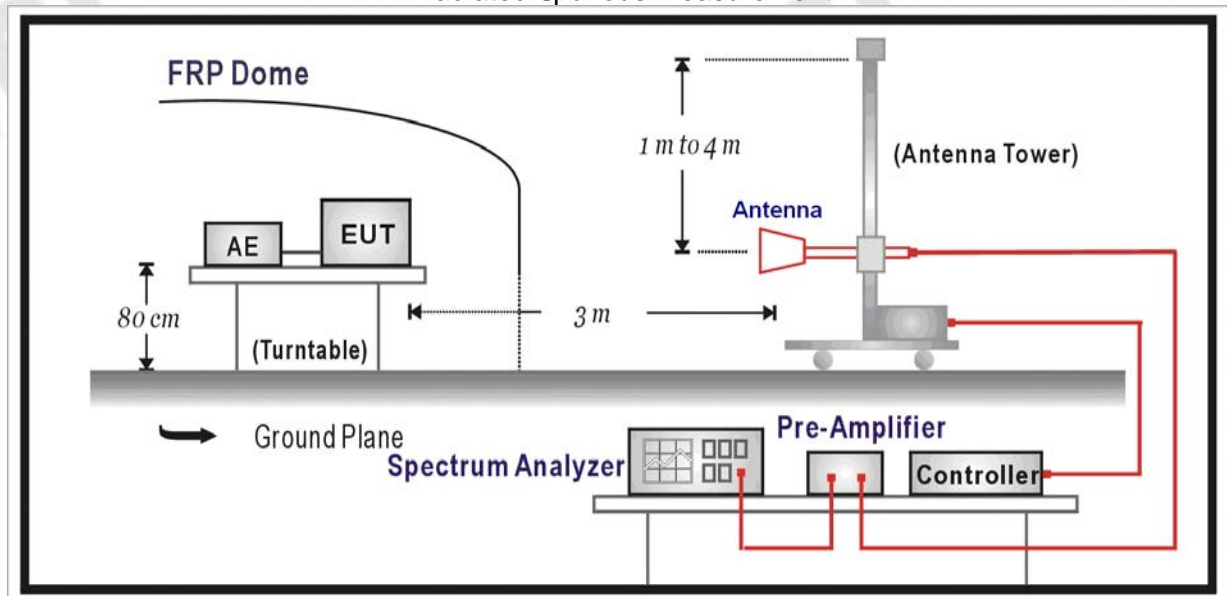

TEST PROCEDURE

The EUT was setup according to ANSI/TIA/EIA-603-E

Conducted Spurious Measurement:

- Place the EUT on a bench and set it in transmitting mode.
- Connect a low loss RF cable from the antenna port to a spectrum analyzer and CMW500 by a Directional Couple.
- EUT Communicate with CMW500 then selects a channel for testing.
- Add a correction factor to the display of spectrum, and then test.
- The resolution bandwidth of the spectrum analyzer was set sufficient scans were taken to show the out of band Emission if any up to 10th harmonic.

Radiated Spurious Measurement:

- a. The EUT shall be placed at the specified height on a support, and in the position closest to normal use as declared by provider.
- b. The test antenna shall be oriented initially for vertical polarization and shall be chosen to correspond to the frequency of the transmitter
- c. The output of the test antenna shall be connected to the measuring receiver.
- d. The transmitter shall be switched on and the measuring receiver shall be tuned to the frequency of the transmitter under test.
- e. The test antenna shall be raised and lowered through the specified range of height until a maximum signal level is detected by the measuring receiver.
- f. The transmitter shall then be rotated through 360° in the horizontal plane, until the maximum signal level is detected by the measuring receiver.
- g. The test antenna shall be raised and lowered again through the specified range of height until a maximum signal level is detected by the measuring receiver.
- h. The maximum signal level detected by the measuring receiver shall be noted.
- i. The transmitter shall be replaced by a substitution antenna.
- j. The substitution antenna shall be orientated for vertical polarization and the length of the substitution antenna shall be adjusted to correspond to the frequency of the transmitter.
- k. The substitution antenna shall be connected to a calibrated signal generator.
- l. If necessary, the input attenuator setting of the measuring receiver shall be adjusted in order to increase the sensitivity of the measuring receiver.
- m. The test antenna shall be raised and lowered through the specified range of height to ensure that the maximum signal is received.
- n. The input signal to the substitution antenna shall be adjusted to the level that produces a level detected by the measuring receiver, that is equal to the level noted while the transmitter radiated power was measured, corrected for the change of input attenuator setting of the measuring receiver.
- o. The measurement shall be repeated with the test antenna and the substitution antenna orientated for horizontal polarization.
- p. The measure of the effective radiated power is the larger of the two levels recorded at the input to the substitution antenna, corrected for gain of the substitution antenna if necessary.
- q. The resolution bandwidth of the spectrum analyzer was set at 100 kHz for Part 22 and 1MHz for Part 24. The frequency range was checked up to 10th harmonic.
- r. Test site anechoic chamber refer to ANSI C63.

TEST RESULTS

Radiated Measurement:

LTE FDD Band 13_Channel Bandwidth 5MHz_QPSK_Low Channel

Frequency (MHz)	PMea (dBm)	Distance (m)	Correction Factor(dB) (dB)	Reading (dBm) (dBm)	Limit (dBm)	Margin (dB)	Polarization
1559.0	-45.22	3	7.68	-52.90	-13	32.22	H
2338.5	-58.19	3	11.73	-69.92	-13	45.19	H
1559.0	-48.08	3	7.92	-56.00	-13	35.08	V
2338.5	-57.37	3	11.46	-68.83	-13	44.37	V

Note: Margin(dB)= Limit (dBm)-PMea(dBm)

LTE FDD Band 13_Channel Bandwidth 5MHz_QPSK_Middle Channel

Frequency (MHz)	PMea (dBm)	Distance (m)	Correction Factor(dB) (dB)	Reading (dBm) (dBm)	Limit (dBm)	Margin (dB)	Polarization
1564.0	-46.12	3	7.57	-53.69	-13	33.12	H
2346.0	-57.68	3	11.68	-69.36	-13	44.68	H
1564.0	-43.50	3	7.85	-51.35	-13	30.50	V
2346.0	-56.73	3	11.39	-68.12	-13	43.73	V

Note: Margin(dB)= Limit (dBm)-PMea(dBm)

LTE FDD Band 13_Channel Bandwidth 5MHz_QPSK_High Channel

Frequency (MHz)	PMea (dBm)	Distance (m)	Correction Factor(dB) (dB)	Reading (dBm) (dBm)	Limit (dBm)	Margin (dB)	Polarization
1569.0	-45.05	3	7.54	-52.59	-13	32.05	H
2353.5	-56.39	3	11.67	-68.06	-13	43.39	H
1569.0	-43.85	3	7.87	-51.72	-13	30.85	V
2353.5	-58.07	3	11.35	-69.42	-13	45.07	V

Note: Margin(dB)= Limit (dBm)-PMea(dBm)

4. Test Setup Photos of the EUT



5. Photos of the EUT

External Photos

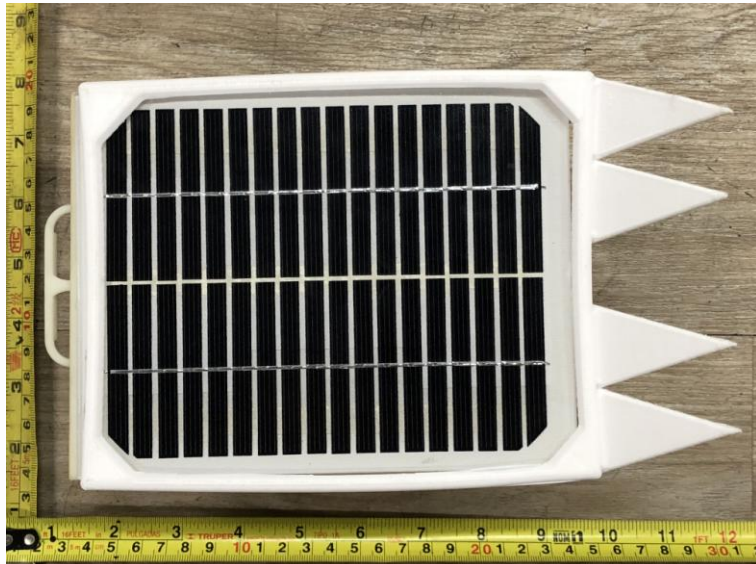

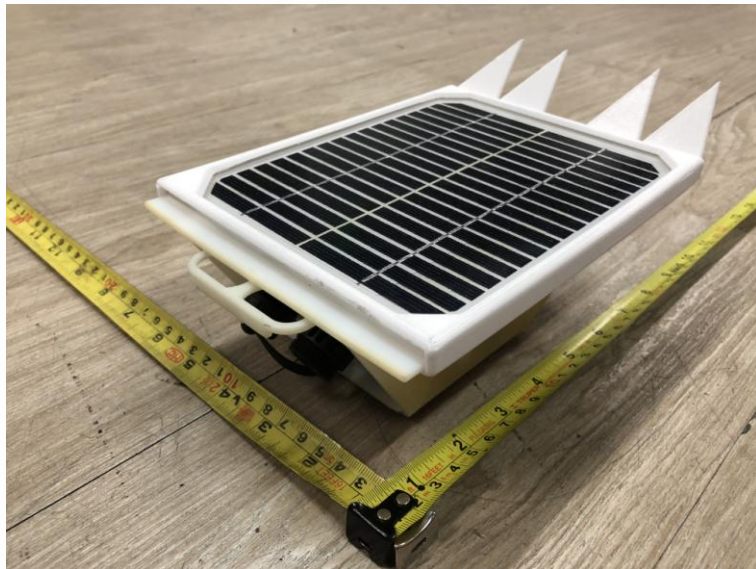



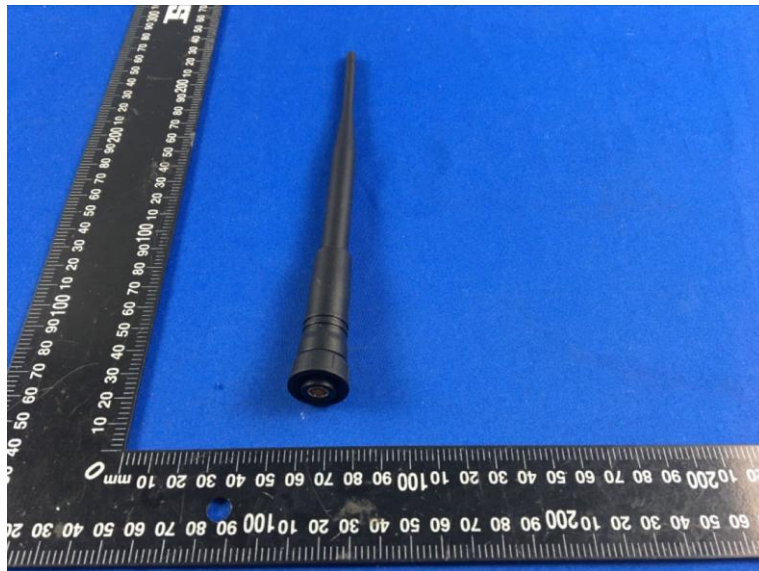

Internal Photos

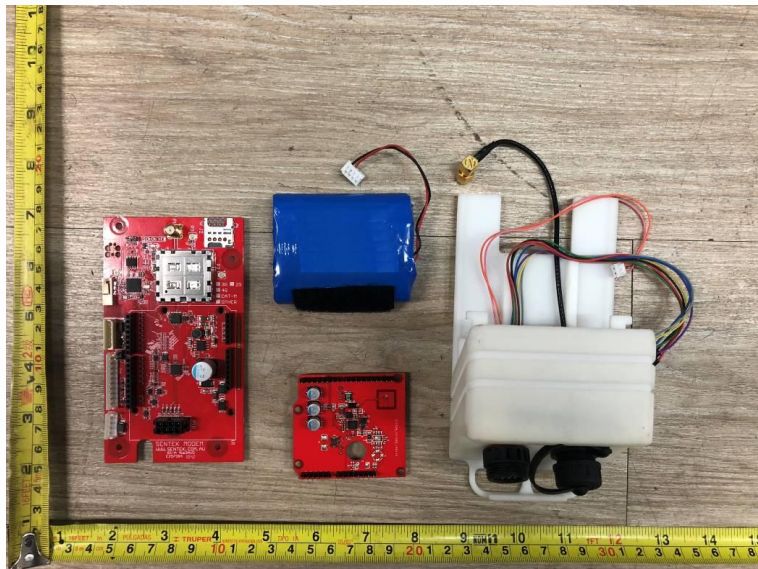
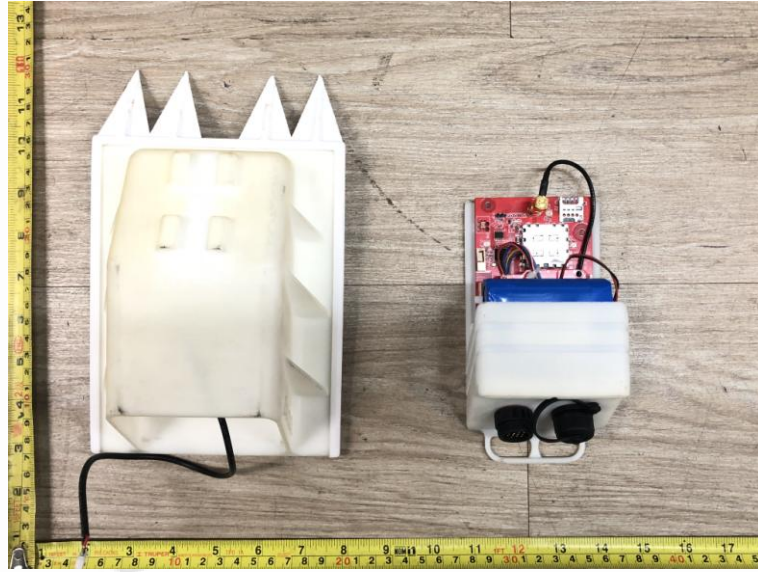

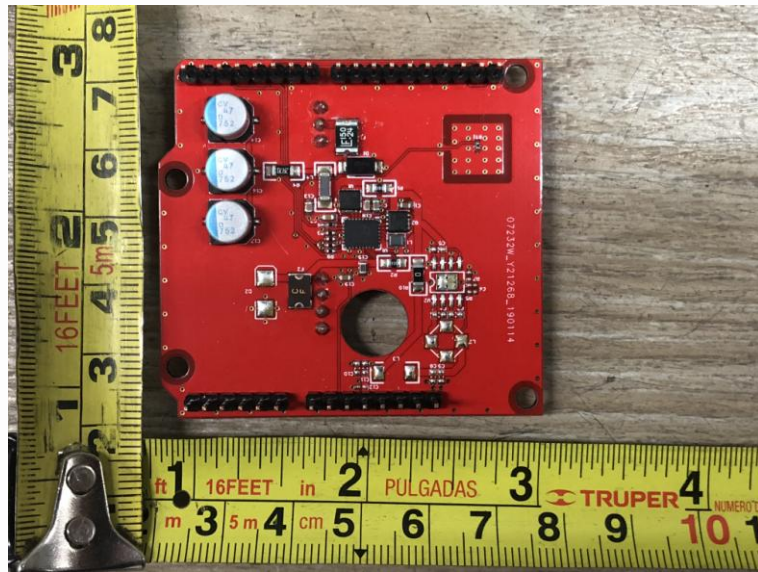
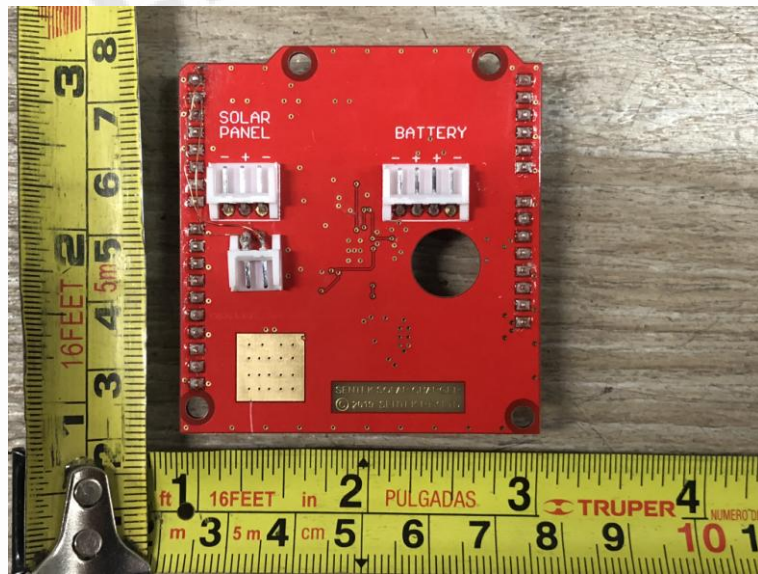
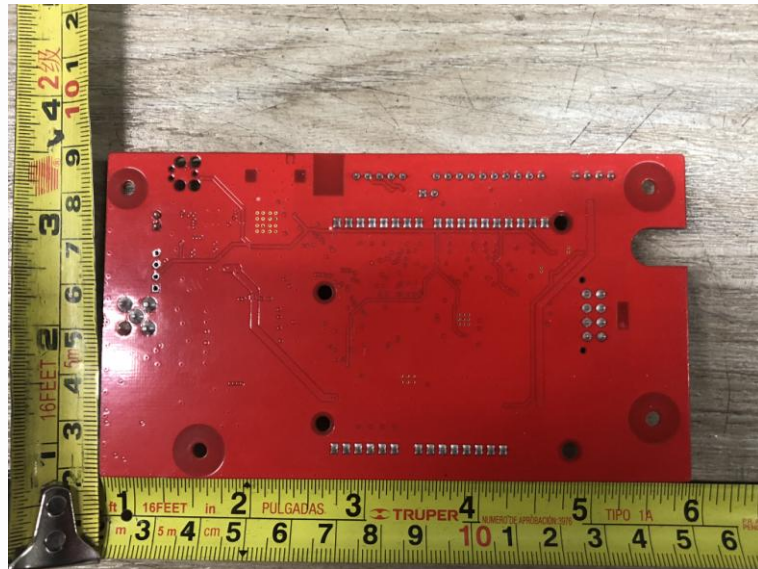



***** End of Report *****