



User Manual

NÜO Go!

ÍNDICE

1.	NÜO Go!	4
1.1.	equipment references	5
1.2.	CONTROLLER AND SECURE DOOR UNITS	6
1.3.	WIRING	12
2.	Installation	13
2.1.	BATTERY CONNECTION	13
2.2.	SHUTTING DOWN THE EQUIPMENT	14
2.3.	NÜO DC GO!8 ASSEMBLY	15
2.4.	SDU AND WILI ASSEMBLY	16
2.5.	SDU+ AND WILI+ ASSEMBLY	17
2.6.	VIDEOCONSOLA W&M VIEW F	18
3.	NÜO Go! equipment information screens	21
3.1.	NÜO DC GO! 8 DISPLAY	21
3.2.	DISPLAY NÜO SDU+	26
3.3.	DISPLAY WILI+	30
4.	Connect to NÜO Go!	34
4.1.	CONSOLE SETTINGS (VIEW DH, VIEW D, VIEW F)	34
4.2.	VOXTER/VOXTER SKY VIDEO-INTERCOM SETTINGS	34
4.3.	CONTROLLER CONNECTION TO PC	35
5.	How to use the equipment for the first time	38
5.1.	FIRST STEPS: REGISTERING A USER	39
5.1.1.	Register users	39
5.2.	FIRST STEPS - DOORS (ACTION AND SET UP).	42
5.2.1.	Door status and actions	42
5.2.2.	Set up an On-line door	44
5.2.3.	Set up an Off-line door	46
5.2.4.	Set up an Console	46

5.2.5. Set up a Video-intercom door	46
Set up warnings	47
5.2.6. Set up the lighting colours of NÜO Sky	47
5.3. REPORTS	48
5.4. MORE SYSTEM OPTIONS	51
6. Diagrams	53
6.1. CONNECTION TO NÜO DC GO! 8	53
6.1.1. CONNECTION FROM THE SDU DOOR UNITS TO NÜO DC GO! 8	53
6.1.2. NÜO SDU AND SDU+ TO NÜO DC GO! 8 CONNECTION	54
6.1.3. Detail of the connection SDU/SDU+ to NÜO DC Go!8	55
6.1.4. DIAGRAM CONNECTION OF THE ELEMENTS OF A DOOR WITH SDU	56
6.1.5. DETAILED DIAGRAM SDU CONNECTION	57
6.1.6. DIAGRAM CONNECTION OF THE ELEMENTS OF A DOOR WITH SDU+	58
6.1.7. DETAILED DIAGRAM SDU+ CONNECTION	59
6.2. VIDEO-INTERCOM CONNECTION TO WILI/WILI+	60
6.2.1. VIDEO-INTERCOM CONNECTION VOXTER TO WILI	60
6.2.2. Voxter and Readers connection to WILI+	61
6.2.3. CONNECTION FROM SKY FLUX/SURF SUPPORT TO WILI+	62
6.2.4. CONNECTION OF SKY POST	63
6.2.5. CONNECTION OF SKY CAR POST/WALK WITH WILI+	64
6.3. W&M CONNECTION TO POE SWITCH	65
7. Information regarding the NÜO DC Go! product	66

Introduction >> Technical Specifications and General Features >



This manual must be read completely in order to avoid problems and confusion during installation which could cause irreparable failures to the system.

The installation and wiring of this product should be supervised by qualified personnel and treated with caution. Follow the instructions at all times.

Do not use abrasive materials to clean the product such as bleach or ammonia. Clean it using a damp cloth with water and/or mild soap.

1. NÜO Go!

The NÜO Go! system is an access control system for 250 users, 8 On-line doors, 48 Off-line doors and 4 Video-intercom doors.

The NÜO Go! System consists of a Multi-Door IP Controller, NÜO DC Go!8, which can manage up to 4 On-line doors and 48 Off-line doors, and can be extended to up to 20 On-line doors using the NÜO DC Slave units.

By means of WILI/WILI+, 4 Video-intercom doors can be added.

It has a system capacity of up to 250 users with cards and fingerprints.

The NÜO Go! application is embedded in the controller. It can be connected to directly through a browser from any device such as a computer or a tablet.

NÜO GO! DIAGRAM

Installation Diagram

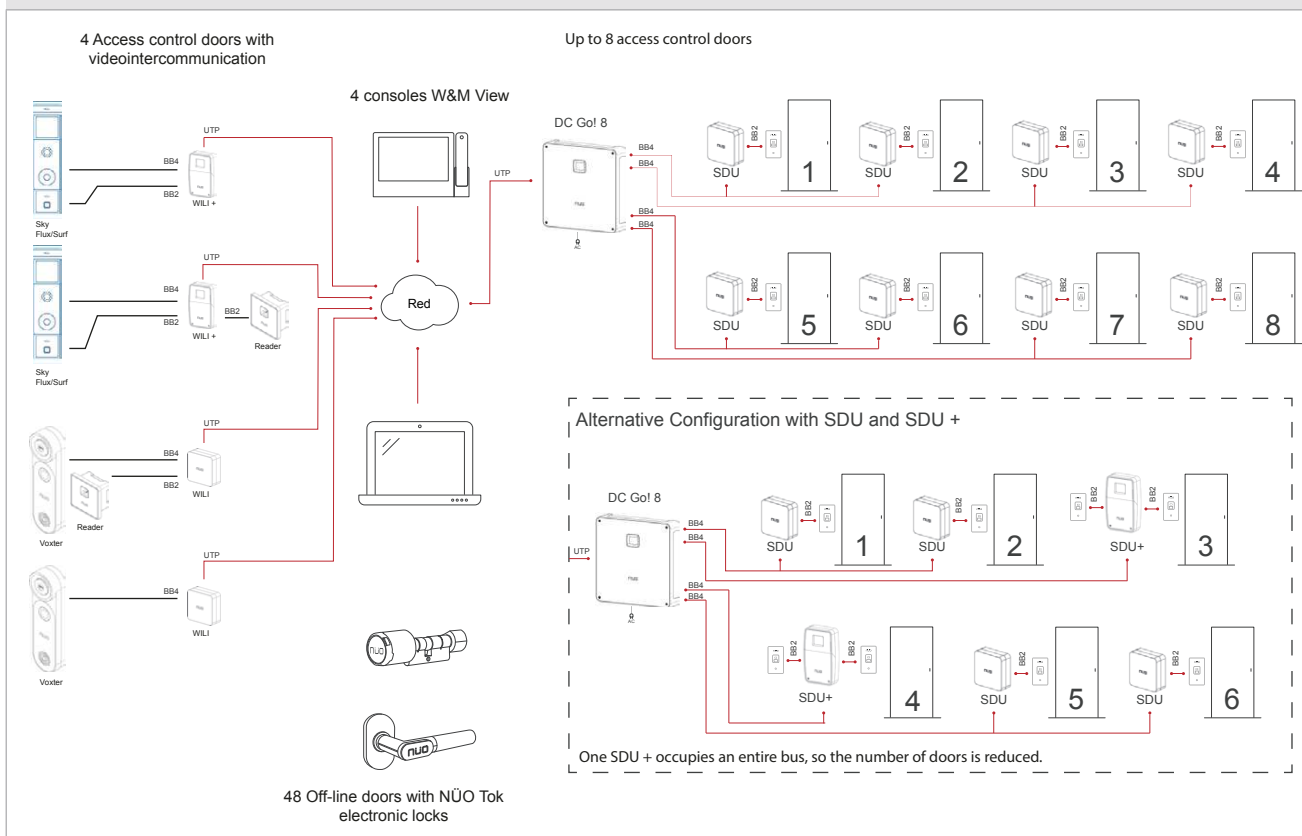



NÜO GO! GENERAL FEATURES

NÜO DC Go! 8

- IP Controller with embedded application.
- Set up from any a browser on any device (computer or tablet).
- TFT-LCD touch screen 1.77" for monitoring the status of the entire installation
- Multi-door management
 - max. 8 On-Line doors,
 - max. 48 Off-Line doors with electronic locks and Data-On-Card communication,
 - max. 4 Video-intercom doors.
- Up to 4 Video-consoles for Video-intercom.
- 250 users with cards and fingerprints.
- Manages authorisations for 25 access groups and 25 timetables.
- Compatible with all NÜO readers.
- Ethernet connection.
- Steel casing with a tough polycarbonate frame
- Operating temperature: : -10 °C a 50 °C.

1.1. EQUIPMENT REFERENCES

This manual serves as an installation and operation guide for the following equipment:

- Ref. 42552 - NÜO DC Go! 8
- Ref. 42530 - NÜO SDU
- Ref. 42550 - NÜO SDU+
- Ref. 42532 - NÜO WILI (SDUY15)
- Ref. 42545 - NÜO WILI+ (SDUY50)
- Ref. 42451 - W&M View

Introduction >> Technical Specifications and General Features >

1.2. CONTROLLER AND SECURE DOOR UNITS

NÜO DC GO! 8 ·CONTROLLER (REF: 42552)·

	INPUT VOLTAGE	In: 100 - 240 VAC Out: 48VDC
	POWER	12 W (without any connected elements) 120 W (with 8 doors and their terminals, without Batteris); 30W máximo por bus
	Number of doors	8
	Number of readers	Per door: 1 with SDU, 2 with SDU+
	BATERÍA	Sealed Lead-Acid (SLA) or GEL batteries. > 4 hours of autonomy (4 doors) > 2,5 hours of autonomy (8 doors)
	OPERATING TEMPERATURE	-10°C to 50°C
	DIMENSIONS	Height 348, Width 348, Depth 75 mm

NÜO SDU ·SECURE DOOR UNIT FOR 1 READER (REF: 42530)·

	INPUT VOLTAGE	48 VDC
	POWER	0,45 W stand-by 1 W maximum
	CONNECTIONS	1 Reader 1 Lock 1 Magnetic sensor 1 Entry Button
	OPERATING TEMPERATURE	-10°C to 50°C
	DIMENSIONS	Height 107, Width 107, Depth 43,8 mm

NÜO SDU+ ·SECURE DOOR UNIT FOR 2 READER + I/O (REF: 42550)·

	INPUT VOLTAGE	48 VDC
	POWER	1,5 W stand-by 2,5 W maximum
	CONNECTIONS	2 Readers 1 Lock 1 Magnetic sensor 1 Entry Button 2 Inputs and 2 Outputs
	OPERATING TEMPERATURE	-10°C to 50°C
	DIMENSIONS	Height 196, Width 116, Depth 49,4 mm

NÜO WILI -SECURE DOOR UNIT FOR VIDEOINTERCOM (REF: 42531)-

	INPUT VOLTAGE	PoE (802.3 af)
	POWER	0,7 W stand-by 1 W maximum
	CONNECTIONS	1 Videointercom Terminal 1 Lock 1 Magnetic Sensor 1 Entry Button
	OPERATING TEMPERATURE	-10°C to 50°C
	DIMENSIONS	Height 107, Width 107, Depth 43,8 mm

NÜO WILI+ -SECURE DOOR UNIT FOR VIDEOINTERCOM & ACCESS CONTROL(REF: 42545)-

	INPUT VOLTAGE	PoE+ (802.3 at)
	POWER	2 W stand-by 3 W maximum
	CONNECTIONS	1 Videointercom Terminal 2 Readers 1 Lock 1 Magnetic Sensor 1 Entry Button 2 Inputs y 2 Outputs
	OPERATING TEMPERATURE	-10°C to 50°C
	DIMENSIONS	Height 196, Width 116, Depth 49,4 mm



For door units, The “LOCK 24V” output feeds the locks at 24 VDC with a maximum power of 8W.

Introduction >> Technical Specifications and General Features >

Proximity Reader:

NÜO RUN		
	INPUT VOLTAGE	24 VDC
	POWER	0,5W stand-by 2W maximum
	OPERATING TEMPERATURE	-10°C to 50°C
	DIMENSIONS	Height 136, Width 49,5, Depth 11,5 mm

NÜO POLO		
	INPUT VOLTAGE	24 VDC
	POWER	0,6 W stand-by 2,1 W maximum
	OPERATING TEMPERATURE	-10°C to 50°C
	DIMENSIONS	Height 170, Width 44, Depth 8 mm (+9,5 mm recessed wall mounting)

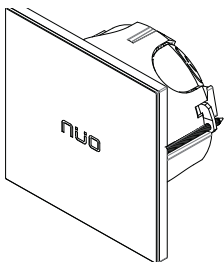
NÜO GOLF		
	INPUT VOLTAGE	24 VDC
	POWER	0,5W stand-by 2 W maximum
	OPERATING TEMPERATURE	-10°C to 50°C
	DIMENSIONS	Height 86, Width 86, Depth 33,5 mm

NÜO AIR		
	INPUT VOLTAGE	24 VDC
	POWER	1,7 W stand-by 2,8 W maximum
	OPERATING TEMPERATURE	-25°C to 60°C (suitable for outdoors)
	DIMENSIONS	Height 114,5, Width 114,5, Depth 62 mm



UHF Remote Readers

NÜO ID		
	INPUT VOLTAGE	24 VDC
	POWER	1 W stand-by 2 W maximum
	ANTENNA GAIN	9 dBi
	OPERATING TEMPERATURE	-20 a 60 °C (suitable for outdoors)
	DIMENSIONS	Height 300, Width 300, Depth 66 mm

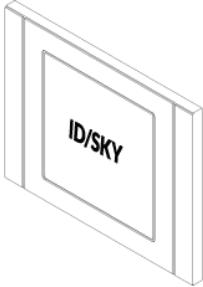
NÜO ID SKY		
	INPUT VOLTAGE	24 VDC
	POWER	1 W stand-by 2 W maximum
	ANTENNA GAIN	6 dBi
	OPERATING TEMPERATURE	-20 a 60 °C (suitable for outdoors)
	DIMENSIONS	Height 150, Width 120, Depth 61,5 mm

Biometric Reader:

NÜO LU		
	INPUT VOLTAGE	24 VDC
	POWER	1,2 W stand-by 1,8 W maximum
	OPERATING TEMPERATURE	-10°C to 50°C
	DIMENSIONS	Height 80, Width 40, Depth 10 mm

Proximity and Biometric Readers:

NÜO LU W		
	INPUT VOLTAGE	24 VDC
	POWER	1,8 W stand-by 2,8 W maximum
	OPERATING TEMPERATURE	-10°C to 50°C
	DIMENSIONS	Height 170, Width 48, Depth 44 mm

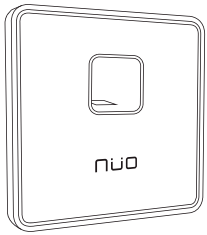
NÜO AWA		
	INPUT VOLTAGE	24 VDC
	POWER	2,8 W stand-by 3,9 W maximum
	OPERATION TEMPERATURE	-10 a 60 °C (suitable for outdoors)
	DIMENSIONS	Height 114,5, Width 114,5, Depth 62 mm

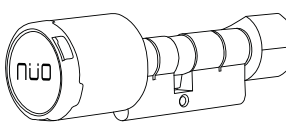

Offline Readers:

NÜO TOK K		
	INPUT VOLTAGE	Two (2) CR2 3V lithium batteries
	Nº MÁX. APERTURAS	Up to 80,000 cycles or 4 years
	OPERATING TEMPERATURE	-20 A 65 °C (Indoor and outdoor models available)

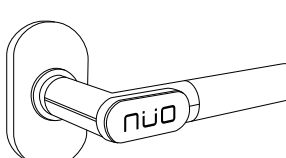
NÜO TOK H		
	INPUT VOLTAGE	One CR123A 3V lithium battery
	Nº MÁXIMO DE APERTURAS	Up to 160.000 openings
	OPERATING TEMPERATURE	-25 A 65 °C (Indoor and outdoor models available)

W&M Video-Console and Video-intercoms

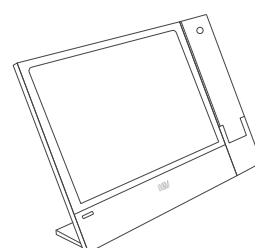
CONSOLAS - W&M VIEW (3 MODELS: F, DH Y D)		
	INPUT VOLTAGE	PoE, (802.3 af)
	POWER	6,5 W stand-by 9 W maximum
	DIMENSIONS	Height 177 mm Width 295 mm (DH), 252 mm (D, F) Depth 122 mm (DH, D), 50 mm (F)

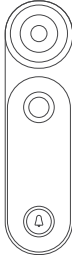
VOXTER		
	INPUT VOLTAGE	24 VDC
	POWER	2,8 W stand-by 5 W maximum
	OPERATING TEMPERATURE	-10 a 60 °C (suitable for outdoors)
	DIMENSIONS	Height 250, Width 65, Depth 39 mm

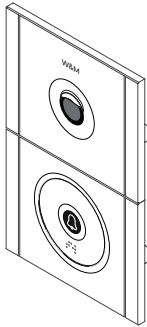
VOXTER SKY		
	INPUT VOLTAGE	24 VDC
	POWER	2,8 W stand-by 5 W maximum
	OPERATING TEMPERATURE	-10 a 60 °C (suitable for outdoors)
	DIMENSIONS	Height 240, Width 150, Depth 50 mm NÜO Sky family mounted

1.3. WIRING

- **BB2 piped cable:** Piped and shielded FTP data cable with 2 twisted pairs of 99.99% stranded pure copper wire (2 x 2 x (7*0.19 copper 99.99% + Ø1.3HDPE) + stranded drain wire). AWG24 resistance. External V0 fire retardant PVC sheath.

- **BB4 piped cable:** Piped and shielded FTP data cable with 4 twisted pairs of 99.99% stranded pure copper wire (4 x 2 x (7*0.19 copper 99.99% + Ø0.9HDPE) + stranded drain wire). AWG24 resistance. External V0 fire retardant PVC sheath.



Use the cables provided. A low quality cable can seriously affect the performance of the equipment.



2. Installation

Follow the instructions in the sections below to install each of the system components.

2.1. BATTERY CONNECTION

The equipment is compatible with the following types of sealed lead-acid and gel batteries: 12V, 7Ah and terminal F1 (FASTON 1). Maximum dimensions: 151 mm length, 65mm width and 100mm height. These dimensions may vary depending on the manufacturer.



Before removing the cover to install/remove the batteries the equipment must be disconnected from the main power supply.

It is vital you install and connect everything in the correct order for everything to work properly.

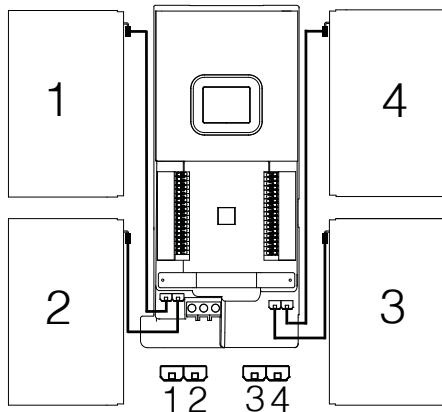

The batteries are not connected by default. They are connected automatically when you select the find doors is option in the application software. If you disconnect the equipment to the main power supply before you configure the software, in other words, without discovering doors, the equipment will go off because the batteries are not connected. Once the doors have been configured, the batteries connect automatically and if the main power supply is lost, they will keep the equipment running for up to approximately 4 hours (with 4 doors) or 2 hours (with 8 doors).

To disconnect the battery from the equipment or replace them, follow the instructions for disconnecting the terminals from the equipment:

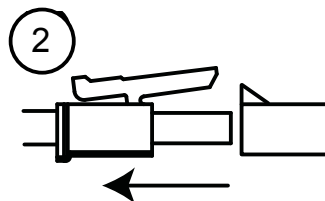
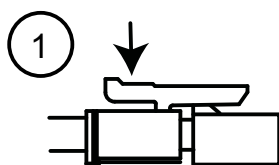

The equipment is supplied without batteries.



2.2. SHUTTING DOWN THE EQUIPMENT

After the equipment has been set up, they shut down under the following situations:

- If there is at least one Door Unit connected to the terminal blocks of the equipment, equipment is powered with batteries if the main power supply is disconnected. The equipment does not shut down.

- When the main power supply is lost and there are no readers neither Wilis and DC Slaves connected, the system shuts down in a controlled manner after 60 seconds approximately.

The equipment shuts down if the main power supply is lost and the batteries are disconnected.



2.3. NÜO DC GO!8 ASSEMBLY

Step 1: Drill holes for 6 mm studs using the box as a template to mark their position. Assemble the equipment using a Philips screwdriver (bolts and studs supplied with the equipment).

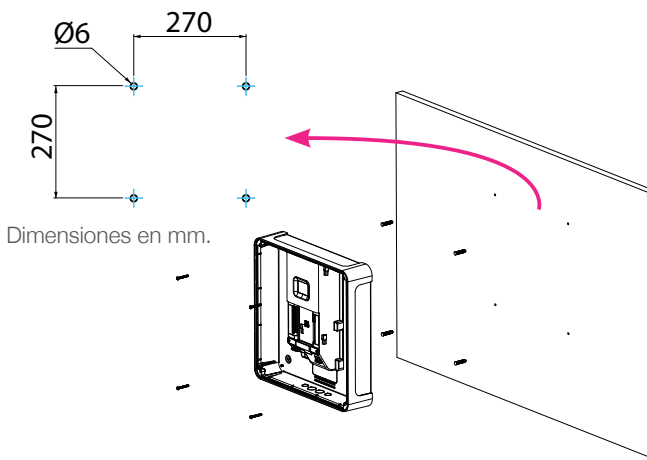

Step 3: Connect the equipment as instructed in "Step 6. Diagrams" "[6. Diagrams](#)". Finally, place the cover on the equipment.

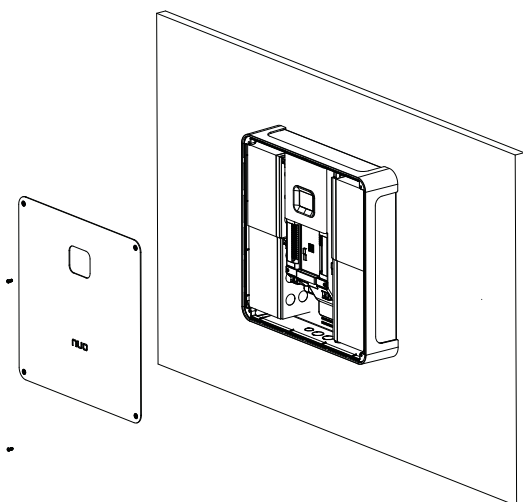

Step 2 (optional): Install the batteries and connect them to the equipment in the order specified.

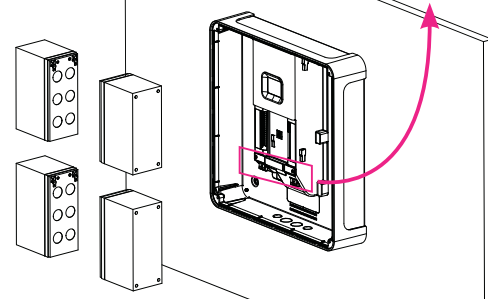
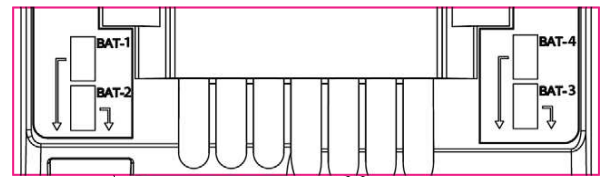

Put the battery retainers to prevent them from moving

Step 4: Equipment installed in the wall.

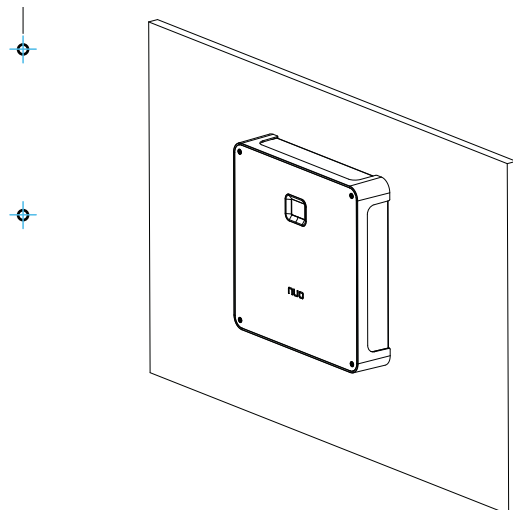

The equipment must be disconnected from the main power supply (230V) before installation. The batteries will not work until the doors have been configured in the NÜO Go! web app.

2.4. SDU AND WILI ASSEMBLY

Step 1: Drill holes for 5 mm studs and fix the support to the wall (bolts and studs supplied with the equipment)

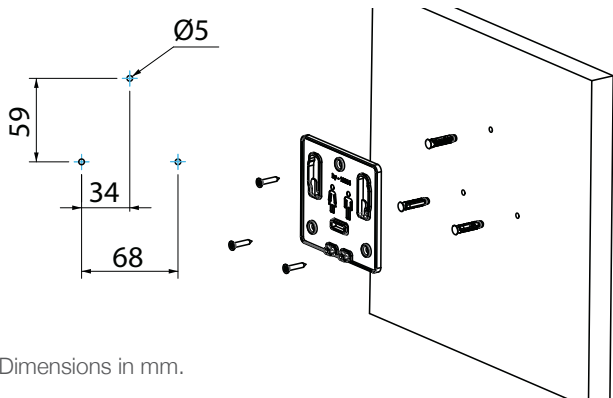

Dimensions in mm.

Step 3: Connect the earth cable.

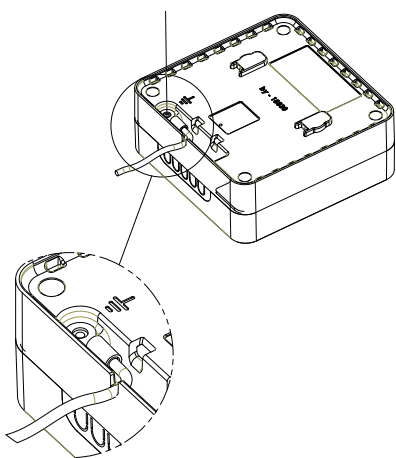

Step 5: Insert the equipment in the support by sliding downwards

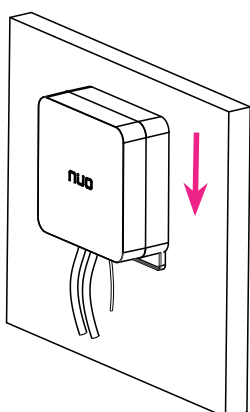

Step 2: Connect the equipment as instructed in "6.Diagrams".

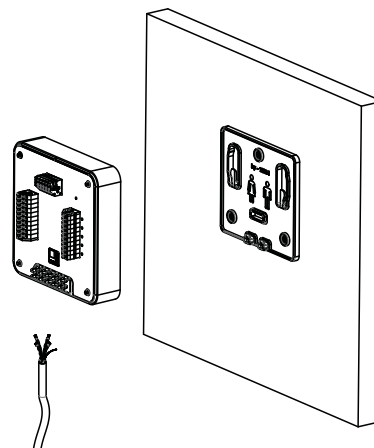

Step 4: Close the box by fixing the cover on the equipment from the back.

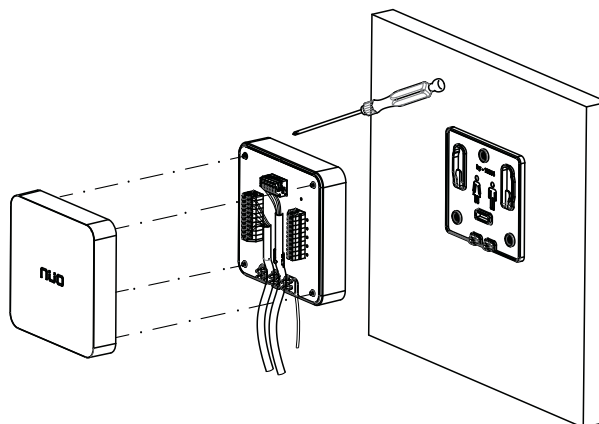

Step 6: Equipment installed in the wall

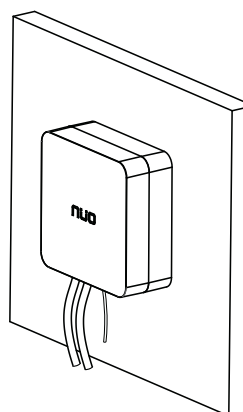



2.5. SDU+ AND WILI+ ASSEMBLY

Step 1: Drill holes for 5 mm studs and fix the support to the wall (bolts and studs supplied with the equipment).

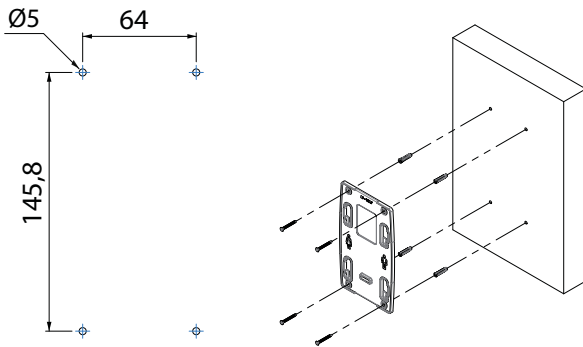

Dimensions in mm.

Step 3: Connect the earth cable

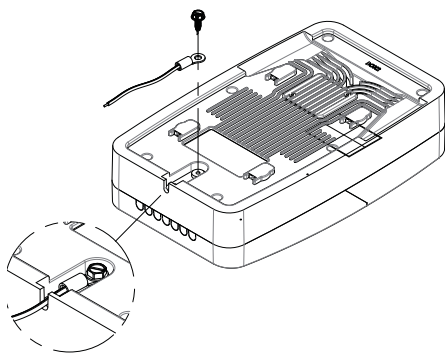

Step 5: Remove the cover to make the connection as instructed in "[6.Diagrams](#)".

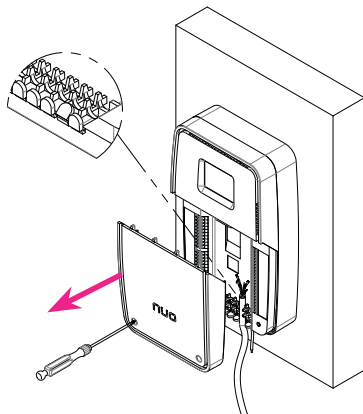

Step 2: Support fixed to the wall

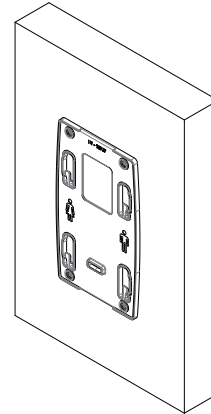

Step 4: Insert the equipment in the support by sliding downwards.

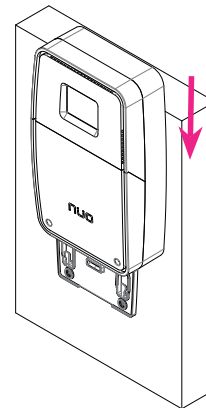

Step 6: Finally, replace the cover on the equipment

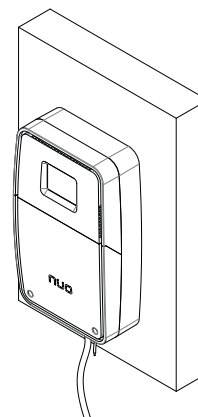

2.6. VIDEOCONSOLA W&M VIEW F

The W&M View F video console can be installed flush in brick walls, plaster prefabs, metal panels, and walls clad with tiles or technical materials. Follow the instructions below to install it correctly:

1.1.) If the wall where the console is to be installed is a solid plasterboard panel type wall, make a hole in the wall with the dimensions specified and insert the support plate.

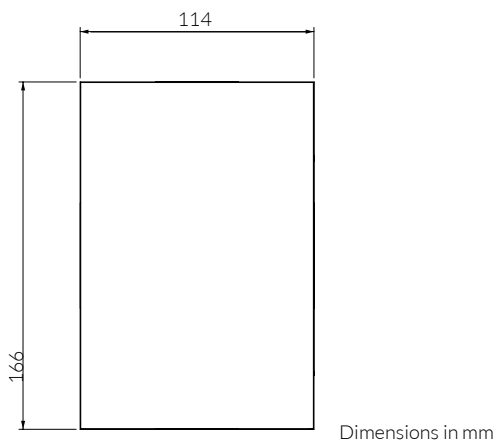

1.2.) If the wall where the console is to be installed is a solid wall (e.g. concrete), make 4 holes for 4mm wall studs at the distances specified, and a central hole with the minimum dimensions noted.

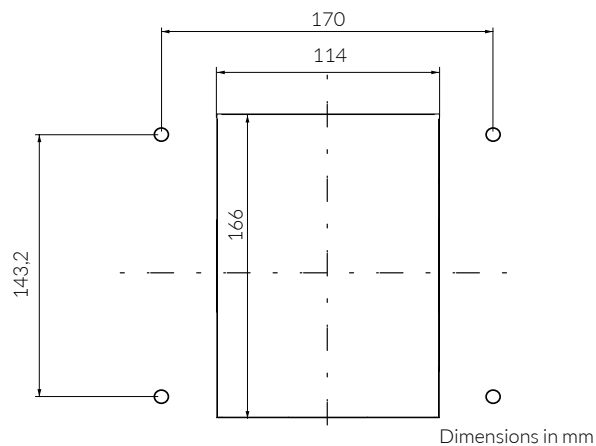

2) Uncover one of the punched holes located in the contour of the sheet metal support to pass the cable through it.

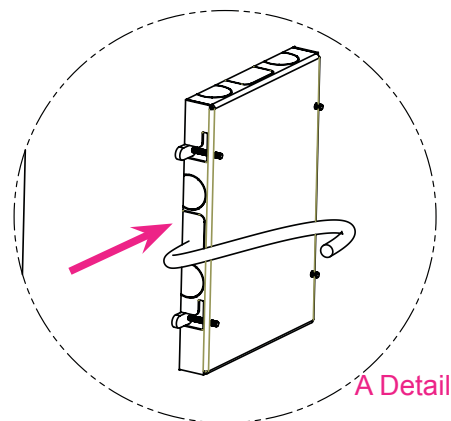
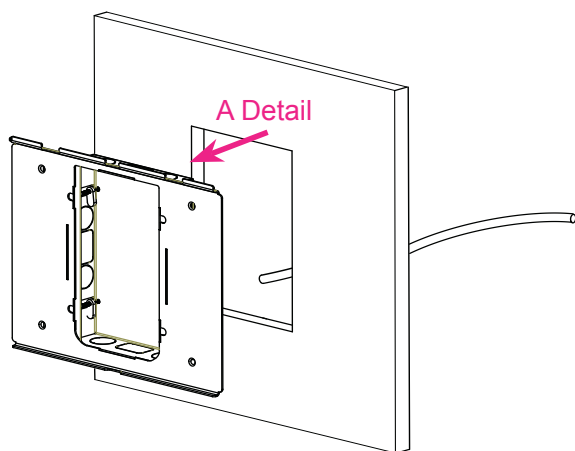



3.1) For solid plasterboard panel type walls, fix the support panel to the wall by tightening the screws included and making sure that the pressure plate is hidden behind the support.

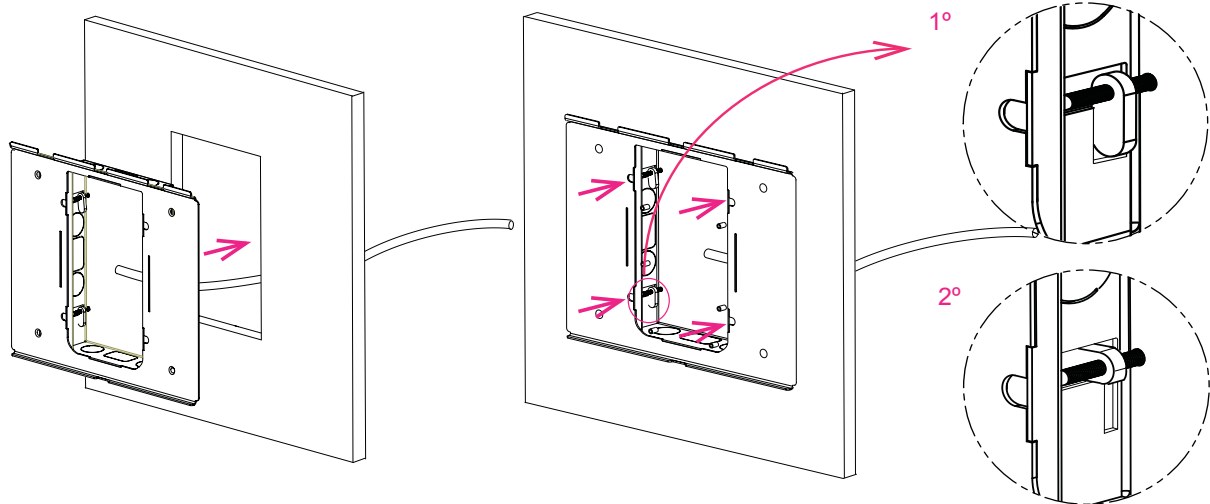

3.2) For concrete walls, insert the studs provided into the holes drilled in the wall and secure the support panel to the wall using 4 screws.

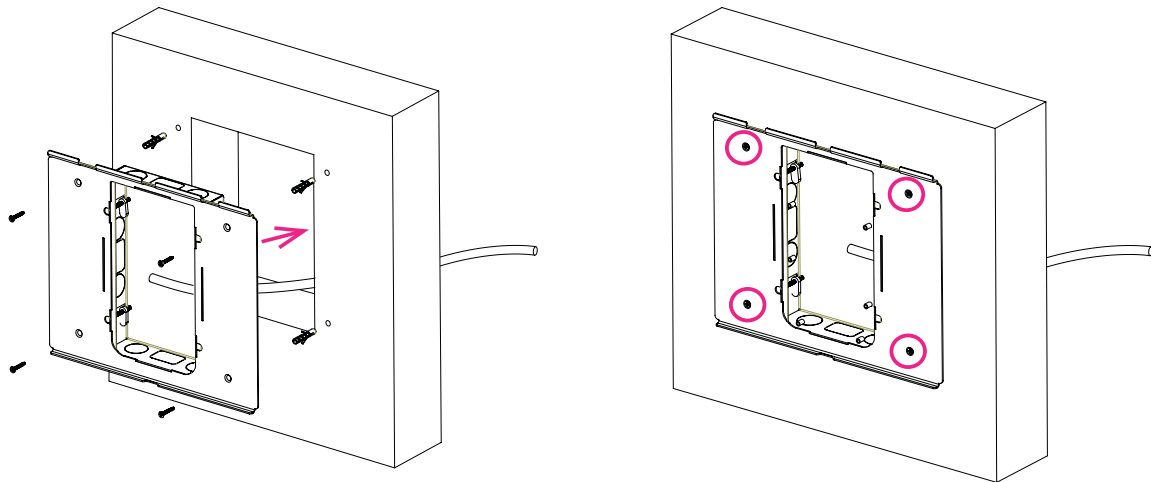

4) Remove the console cover to connect the cable to the terminal block, following the colour code.

5) Replace the console cover and screw it to secure it in place.

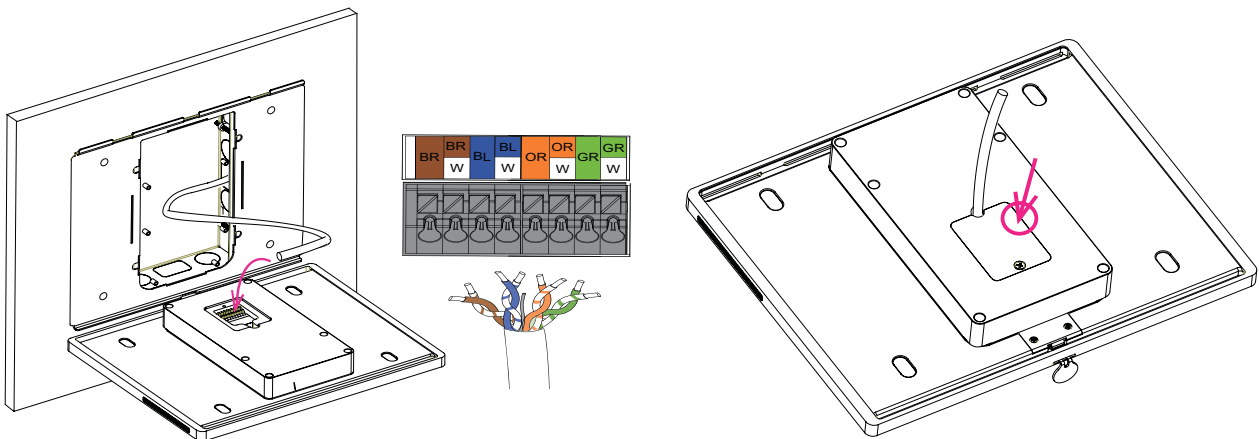



6) Insert the detachable key into the console, and push the support into place by sliding it downwards until you hear "click".

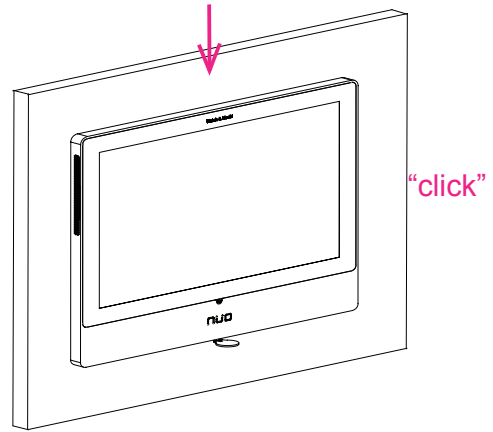
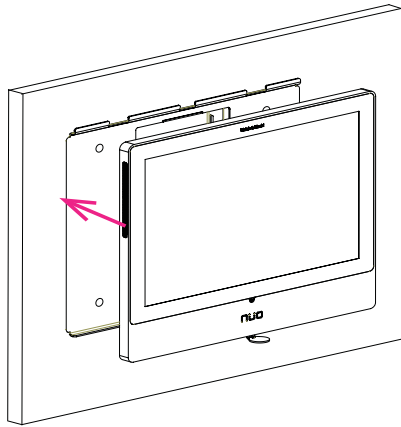

7) Remove the detachable key.

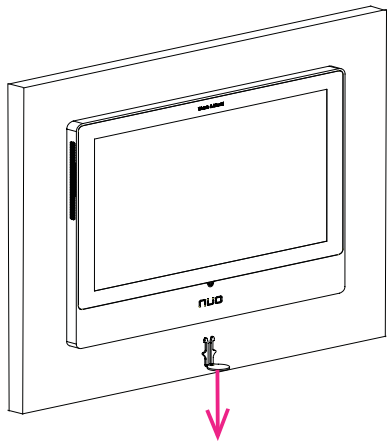

3. NÜO Go! equipment information screens

NÜO DC Go! 8, SDU+ and WILI+ equipments have a colour touch screen that displays information and the status of equipment and doors.

3.1. NÜO DC GO! 8 DISPLAY

The NÜO DC Go! 8 display shows information about the installation and on the status of the doors.

Users can browse through these screens interactively using the icons on the touch screen.

NÜO DC Go! 8 SCREEN:

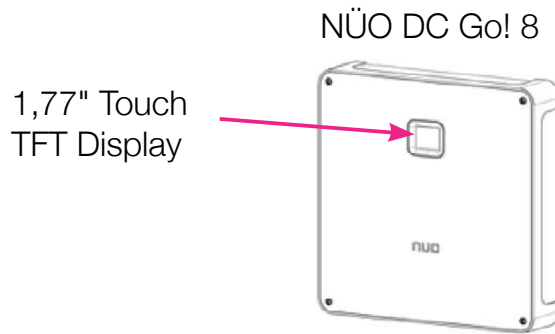

The screen sequence for the NÜO DC Go!8 controller is as follows:

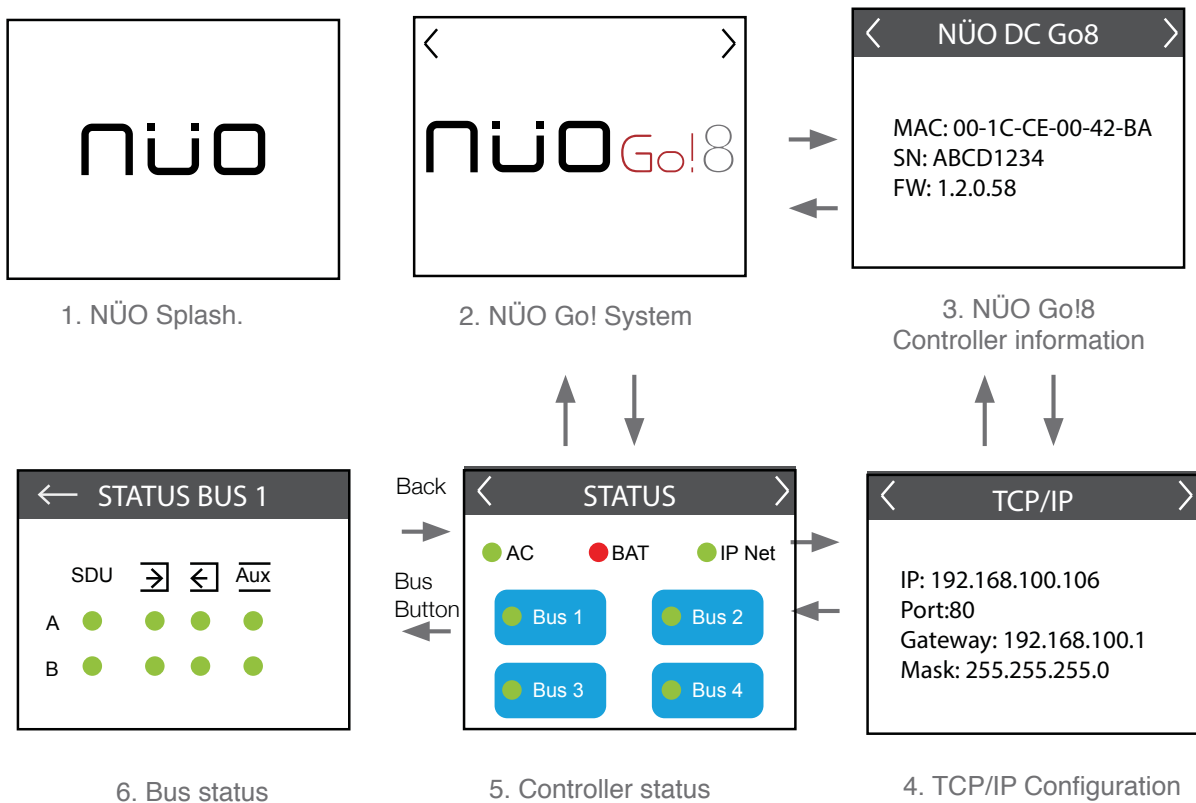

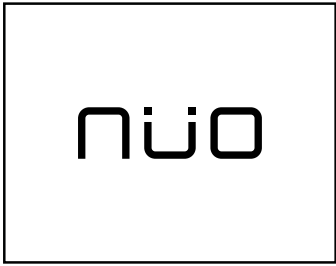

1. NÜO Splash

This screen is only shown temporarily while the equipment starts up after being turned on for the first time. NÜO logo displayed.



2. NÜO Go!8 System

Shows the NÜO Go! 8 logotype when the equipment has turned on.

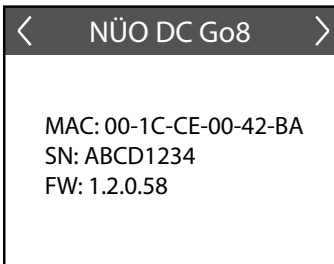

3. Information regarding the controller.

Controller name: NÜO DC Go!8

MAC: Controller MAC number displayed.

NS (Serial Number.): Controller series number displayed.

FW (Firmware): Controller Firmware version.

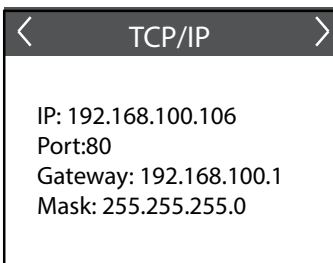

4. TCP/IP Configuration

Información sobre los datos de red:

IP: Displays controller IP number

Port: Displays controller connection port

Gateway: Displays the Gateway number of the controller.

Mask (Subnet Mask): Displays the number of the Subnet Mask of the controller.

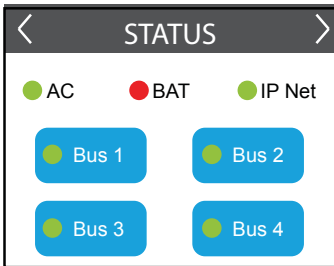

5. Controller Status

Displays the status of power supplies and connections in the controller.

AC: indicates the status of the power supply to the equipment.

- - Grey: no power.
- - Red: insufficient power.
- - Green: the power supply is correct.

BAT: indicates the general status of the batteries:

Battery charging: when the battery is charging:

- - Grey: no batteries detected.
- - Red: battery error..
- - Orange: batteries charging.
- - Green: batteries charged.

Battery discharging: when the battery is discharging:

- - Flashing red: low battery, the equipment is about to go dead.
- - Green: batteries discharging.

IP NET: indicates network connection.

- - Red: no network connection.
- - Green: connected.

BUS "x": power supply to the buses.

- - Red: insufficient power.
- - Green: the power supply is correct.

6. Bus status:

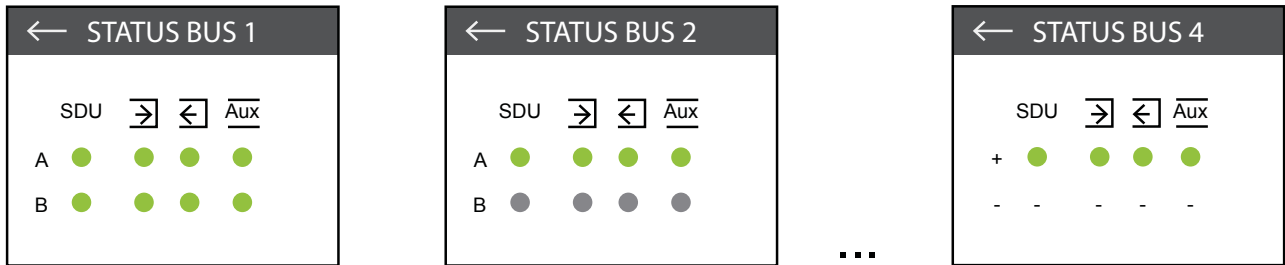

Each bus has a status screen. Each screen shows the number of doors connected to the bus (a maximum of two) A and B.

SDU $\overline{\text{SDU}}$: shows the connection status of the port units in the bus.

- - Grey: no door units configured.
- - Red: door unit configured but no connection detected.
- - Green: door unit configured and connected.

Input Terminal $\overrightarrow{\text{I}}$: shows the configuration status of the readers configured as Entry.

- - Grey: no readers configured.
- - Red: reader configured but no connection detected.
- - Green: reader configured and connected.

Output terminal $\overleftarrow{\text{O}}$: shows the configuration status of the readers configured as Exit.

- - Grey: no readers configured.
- - Red: reader configured but no connection detected.
- - Green: reader configured and connected.

Auxiliary terminal $\overline{\text{Aux}}$: shows the configuration status of the readers configured as Auxiliary.

- - Grey: no readers configured.
- - Red: reader configured but no connection detected.
- - Green: reader configured and connected.

7. Battery failure:

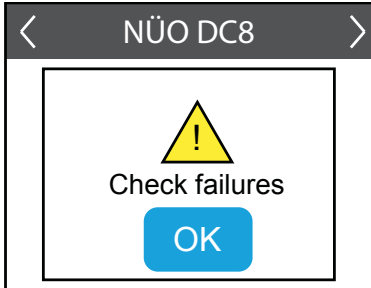

BATTERY FAILURE WARNING:

In case of a battery failure or fault, the following message appears. This message only appears the first time the fault is detected:

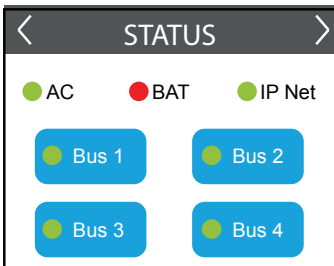

CONTROLLER STATUS

Click OK and navigate to the “Controller Status” screen and the battery status indicator will appear in red:  :

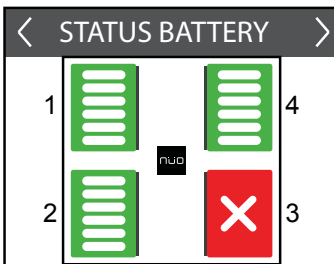

STATUS BATTERY

When you navigate to the next screen you will find the “Battery Status” screen, indicating a fault in the battery or batteries. This screen will appear until you correct the fault.

8. Battery disconnection

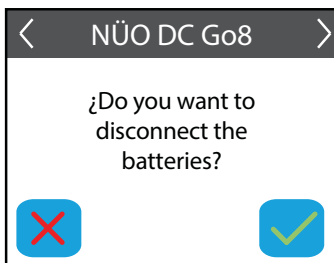

BATTERY DISCONNECT SCREEN:

If the equipment has been disconnected from the main power supply once the doors have been set up, the following screen is then displayed.

In this case, to shut down the equipment it is necessary deactivate the battery.



If you open the equipment once the doors are configured, the batteries will be active even if the equipment has been disconnected from the main 230V power supply. The batteries will be disconnected through this screen.

3.2. DISPLAY NÜO SDU+

The SDU+ 8 display shows information about the status of the door and its elements. Users can browse through these screens interactively using the icons on the touch screen

NÜO SDU+ SCREENS:

1,77" Touch TFT Display

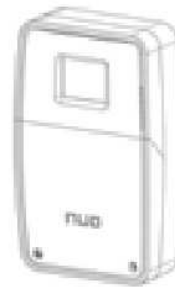

The screen sequence for the SDU+ Door Unit is as follows:

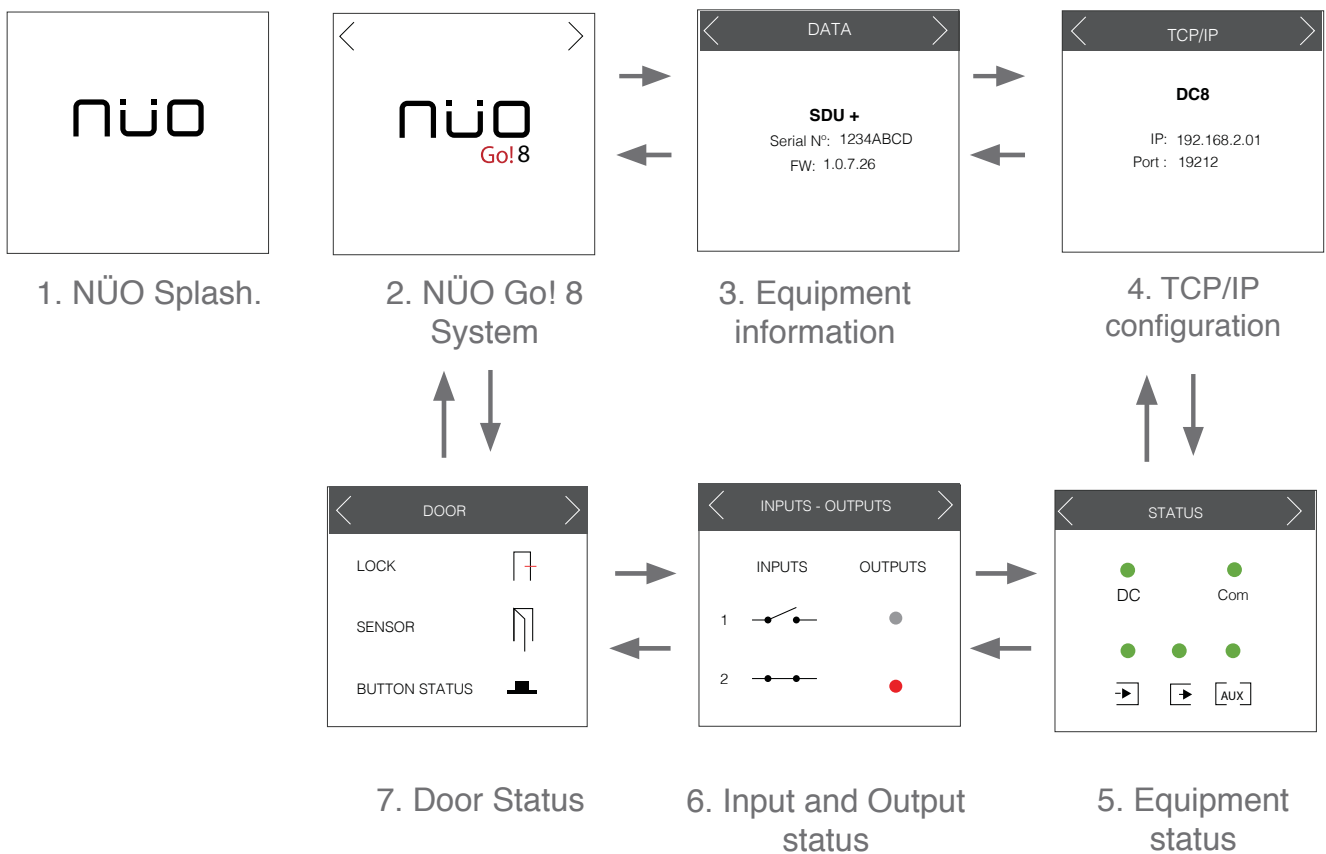



1. NÜO Splash

This screen is only shown temporarily while the equipment starts up after being turned on for the first time. NÜO logo displayed.



2. NÜO Go! 8 System

Shows the NÜO Go! 8 logotype when the equipment has turned on.

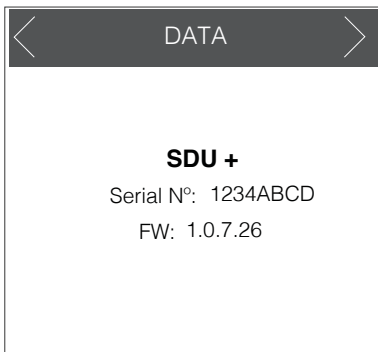

3. NÜO SDU+ Unit door information

Information regarding the Door Unit:

NÜO SDU+: Equipment name.

NS (N° De Serie): Door Unit series number displayed

FW (Firmware): Door Unit Firmware version.

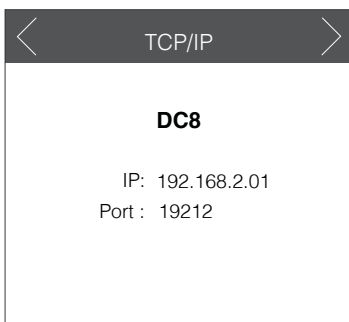

4. TCP/IP Configuration

Shows information regarding the Controller and its network data

DC Go! 8: Controller name which is connected.

IP: IP of Controller.

Port: Port Number of Door Unit

5. Equipment Status

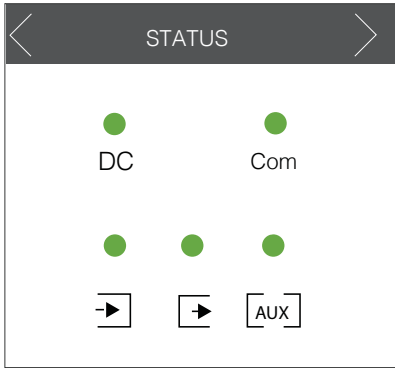

Displays the status of power supplies and connections .

DC: indicates the status of the power supply to the equipment.

- - Red: insufficient power.
- - Green: the power supply is correct.

Com: configuration/communication status

- - Red: non set up or without connection.
- - Green: set up or with connection

Entry Reader : shows the configuration status of the readers configured as Entry.

- - Grey: no reader configured.
- - Red: reader configured but no connection detected.
- - Green: reader configured and connected.

Exit Reader : shows the configuration status of the readers configured as Exit.

- - Grey: no reader configured.
- - Red: reader configured but no connection detected.
- - Green: reader configured and connected.

Auxiliary terminal : shows the configuration status of the readers configured as Auxiliary.

- - Grey: no reader configured.
- - Red: reader configured but no connection detected.
- - Green: reader configured and connected.

6. Input and output status:

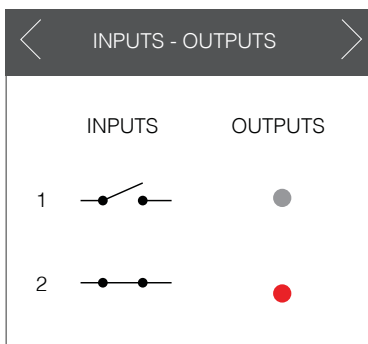

Shows input and output status.

INPUTS: shows the status of inputs.

- : inactive input.
- : active input.

OUTPUTS: shows the status of outputs.

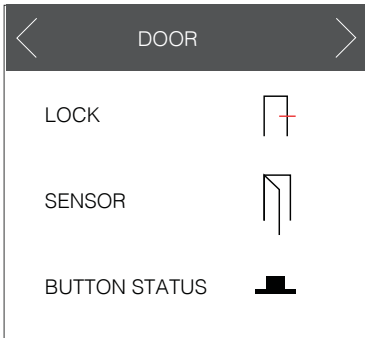

- - Grey: inactive output.
- - Red: active output.





7. Door Status



Shows the status of the elements connected to the door:

Lock: indicates the status of the lock on the door.



-  : - NO lock with power
-  : - NC lock without power

-  : - NO lock without power
-  : - NC lock with power

Sensor: door sensor status.

-  : door closed, sensor active.
-  : door open, sensor inactive.

Push button status: shows the status of the Entry Push button

-  - Red: Push button inactive.
-  - Green: Push button active.

3.3. DISPLAY WILI+

The Wili+ display shows information about the status of the door and its elements. Users can browse through these screens interactively using the icons on the touch screen

NÜO WILI+ SCREENS:

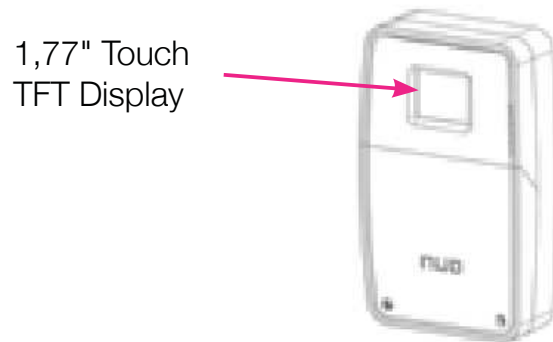

The screen sequence for the WILI+ Door Unit is as follows:

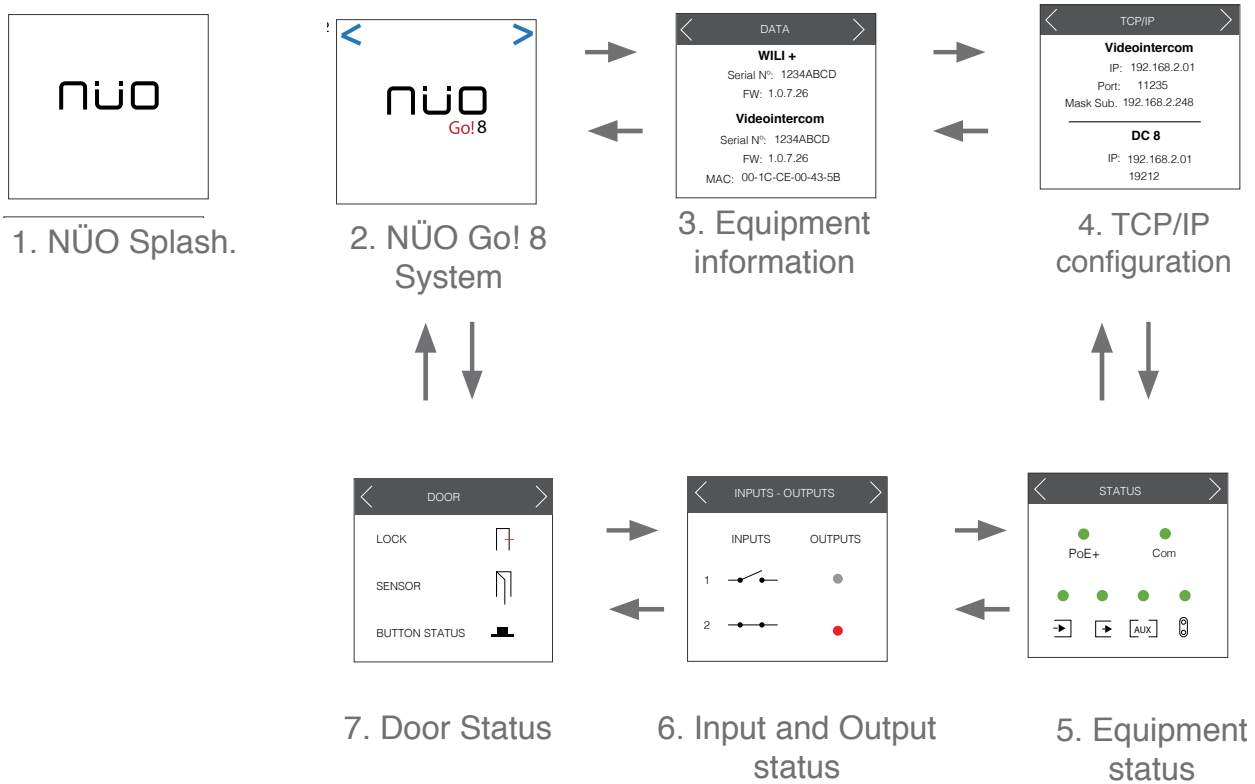

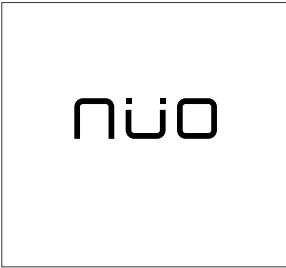

1. NÜO Splash

This screen is only shown temporarily while the equipment starts up after being turned on for the first time. NÜO logo displayed.



2. NÜO Go! 8 System

Shows the NÜO Go! 8 logotype when the equipment has turned on.



3. NÜO WILI+ Unit Door information

Information regarding the Door Unit and the Videointercom:

NÜO WILI+: Equipment name.

NS (Serial Number): Door Unit serial number displayed

FW (Firmware): Door Unit Firmware version.

Videointercom: Name of the Videointercom terminal connected.

NS (Serial Number): Videointercom terminal serial number displayed

FW (Firmware): Videointercom terminal Firmware version.

MAC: Videointercom terminal MAC number

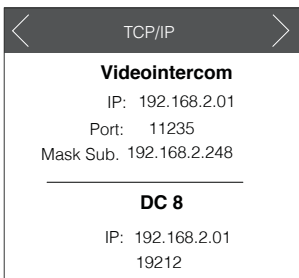

4. TCP/IP Configuration

Shows information regarding the Terminal Network data and the controller which is connected.

Videointercom: Name of the Videointercom terminal connected.

IP: IP number of the Videointercom terminal.

Port: Port Number of the Videointercom terminal.

Mask: Sub-net Mask number of the Videointercom terminal.

DC Go! 8: name of the controlled which is connected.

IP: IP number of the controller.

Port: Port number of the controller.

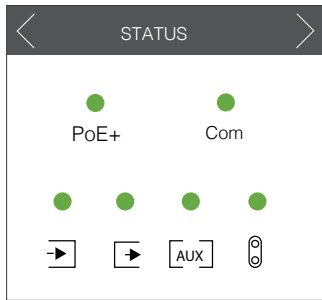

5. Equipment Status

Displays the status of power supplies and connections .

DC: indicates the status of the power supply to the equipment.

- - Red: insufficient power.
- - Green: the power supply is correct.

Com: configuration/communication status

- - Red: without link.
- - Green: with link

Entry Reader : shows the configuration status of the readers configured as Entry.

- - Grey: no reader configured.
- - Red: reader configured but no connection detected.
- - Green: reader configured and connected.

Exit Reader : shows the configuration status of the readers configured as Exit.

- - Grey: no reader configured.
- - Red: reader configured but no connection detected.
- - Green: reader configured and connected.

Auxiliary terminal : shows the configuration status of the readers configured as Auxiliary.

- - Grey: no reader configured.
- - Red: reader configured but no connection detected.
- - Green: reader configured and connected.

Videointercom : shows the configuration status with the Videointercom

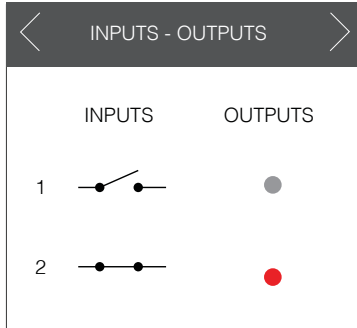

- Red: without connection.
- Green: with connection.



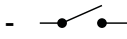

6. Input and output status:

Shows input and output status.

INPUTS: shows the status of inputs.

-  : inactive input.
-  : active input.





OUTPUTS: shows the status of outputs.

-  - Grey: inactive output.
-  - Red: active output.

7. Door Status



Shows the status of the elements connected to the door:

Lock: indicates the status of the lock on the door.

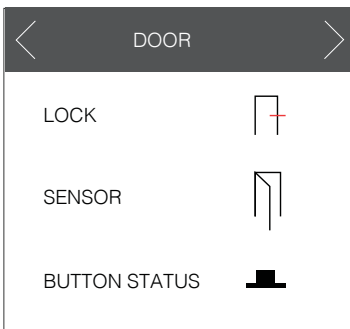

-  : - NO lock with power
-  - NC lock without power
-  : - NO lock without power
-  - NC lock with power



Sensor: door sensor status.

-  : door closed, sensor active.
-  : door open, sensor inactive.

Push button status: shows the status of the Entry Push button

-  - Red: Push button inactive.
-  - Green: Push button active.

Configuration >> NÜO Go!

4. Connect to NÜO Go!

Set the NÜO Go! network parameters before connecting the video consoles and video-intercoms to the network.



Make sure you have set the definitive NÜO DC Go! network parameters before setting up the video-intercom and console network parameters.

4.1. CONSOLE SETTINGS (VIEW DH, VIEW D, VIEW F)

Connect the video console to a data network with a PoE supply. The video consoles have a set-up wizard.

Enter the new IP and network parameters on the next screen. Also enter the NÜO DC Go! equipment IP and port number in the IP server and port fields. The default port is 9997. Confirm by pressing √.

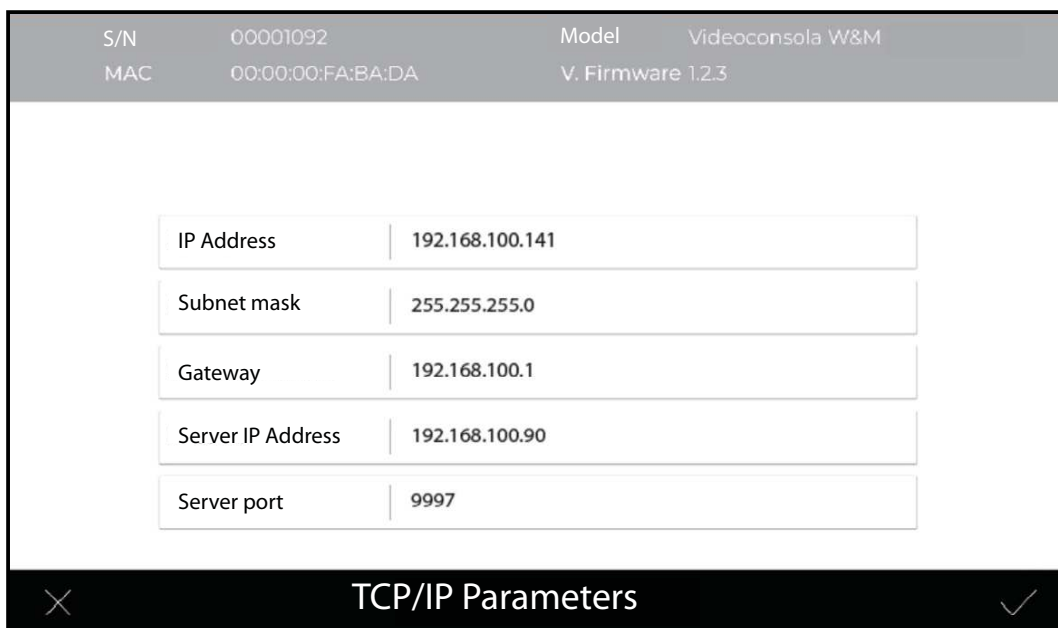

4.2. VOXTER/VOXTER SKY VIDEO-INTERCOM SETTINGS

Enter the default video-intercom IP in any web browser (192.168.100.120).

The PC should be connected to the same TCP/IP network as the devices. To create a new network, use an IP address in the 192.168.100.x range (where “X” is a number between 1 and 255, except for 120 and 140 which are already in use).



Configuration >> NÜO Go!

Change the default IP address on the web page displayed for a new one, by entering the NÜO DC Go! IP and port in the Server and Port fields. The default port is 9997.

NÜO Go! compatibility mode should be selected.

Press ✓ and wait for a few seconds for the intercom to take on the new settings.



Note that the default IP address for the VOXTER IP and the VOXTER SKY is the same, so you need to change the settings to the new IP address, connecting them one at a time to avoid duplicate IP addresses.

4.3. CONTROLLER CONNECTION TO PC

There are two ways you can connect to your NÜO Go! controller and start to use it.

- Connect your computer to the controller directly using a network cable.
- Connect the controller with a computer using a switch.

The factory IP of your NÜO DC Go! is <http://192.168.100.90>. You can confirm this IP address on the NÜO DC Go! controller LCD screen.

> Manual configuration option (MAC OS X)

1. Access the operating system settings/network preferences window:
On a **MAC OS X**, this is found in Applications / System Preferences / Network
2. Create a new service (press the button + and choose Ethernet)
3. Manually set up a new IPv4 network
4. Introduce the controller IP address (by default the factory IP is 192.168.100.X), or the IP displayed on the NÜO DC Go! LCD, and enter the subnet mask.
5. Apply/save configuration

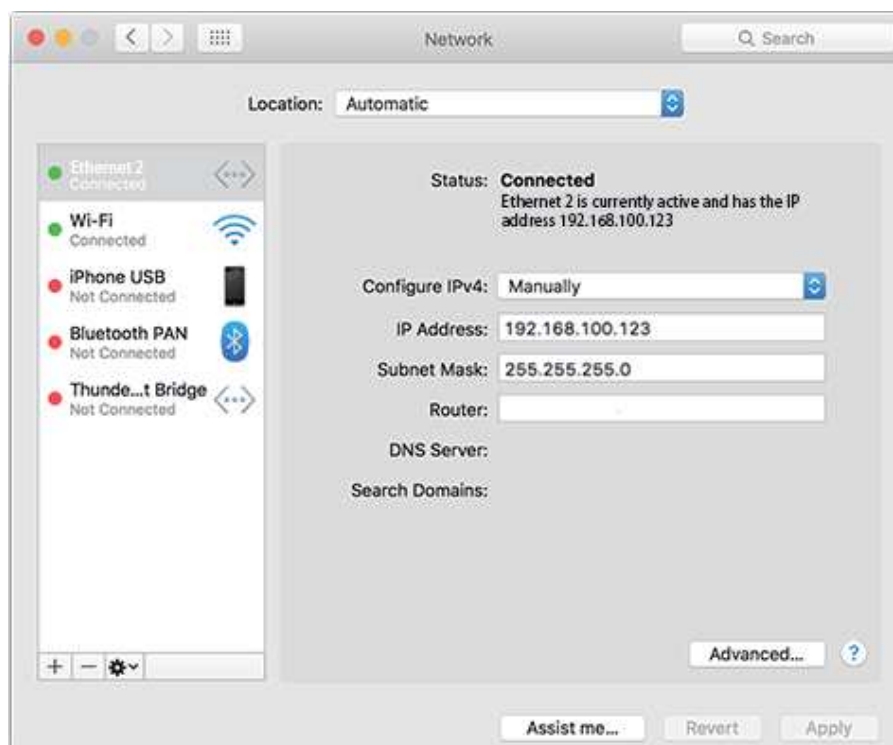

Access the application via the default IP address: <http://192.168.100.90> to launch the setup wizard for the first time. Change the NÜO DC Go! IP address when setting up the TCP/IP network as required.



If the default IP address cannot be accessed, try adding port 80 to this address, i.e. by entering: 192.168.100.90:80 in the browser.



If the DHCP option has been set up in the NÜO Go! System and 0.0.0.0 appears as the IP address on the LCD screen, you will need to reconnect to the Go! System, connect it to a DHCP network, and restart the equipment in order to obtain a new IP address.

Configuration >> NÜO Go!

> **Manual configuration option (WIN 10 or earlier)**

1. Access the operating system settings/network preferences window:
 In **WIN 7/8/10** this is found in
 - Press the Home icon
 - Type “Control Panel”. Select the Control Panel button
 - Go to Control Panel / All Control Panel Items / Network and Sharing Centre.
2. Select the network that you want to change and then select Properties
3. Make sure that you have not selected DHCP
4. Manually set up the IPv4 by introducing the controller IP address (by default the factory IP is 192.168.100.X), or the IP displayed on the NÜO DC Go! LCD, and enter the subnet mask.
5. Apply/save configuration

Access the application via the default IP address: <http://192.168.100.90> to launch the setup wizard for the first time. Change the NÜO Go! IP address when setting up the TCP/IP network as required.

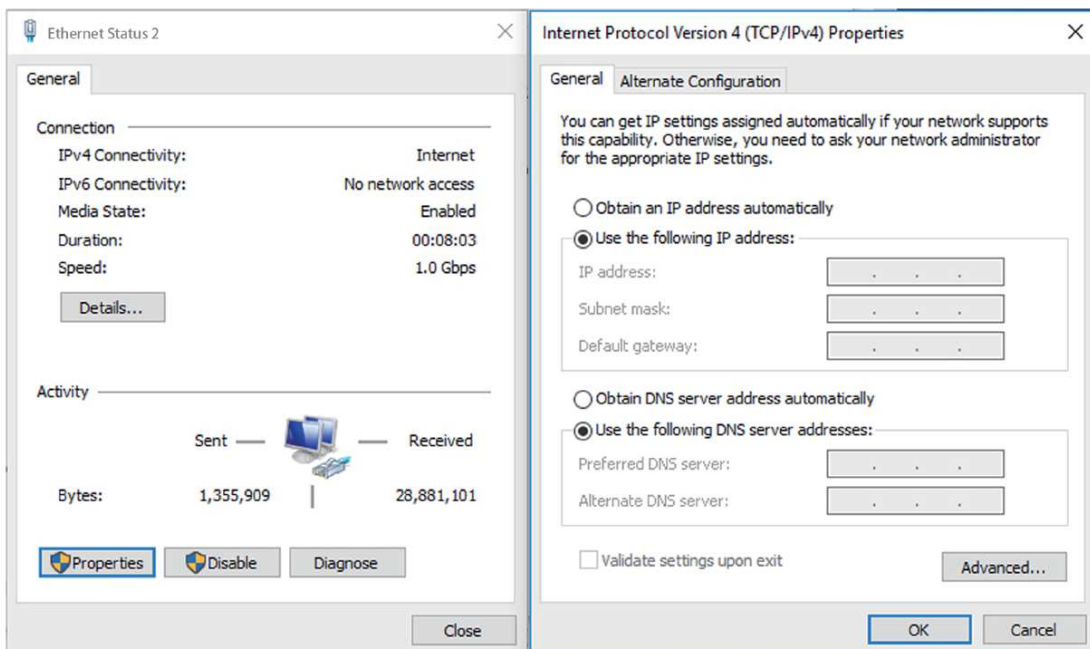

5. How to use the equipment for the first time

Follow these steps to set up your NÜO Go!

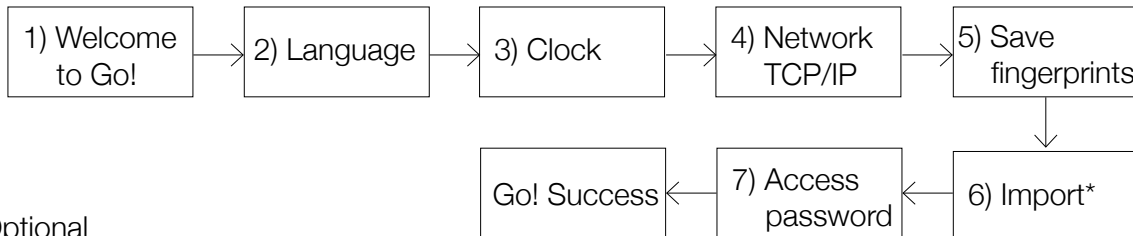

*Optional

Enter the NÜO Go! default IP address in your browser: <http://192.168.100.90/>

1. Go! Welcome screen
2. Select the application language.
3. Select a system date and time.
4. Set up the controller TCP/IP network.

DHCP option: an available IP in the network is automatically assigned to NÜO Go!

Without DHCP: to manually set up the connections. For example, if a specific IP is assigned to NÜO Go!

5. Select where you would like fingerprints to be saved. NÜO Go! is able to save fingerprints in its system or on cards that users carry with them (fingerprint on card).
6. Start from scratch, or if you wish, import a saved configuration.
7. Assign a password to the system to access the web application. You will be able to register or unregister a user, download reports, set up the system, and more.
8. You have completed the NÜO Go! set up. Wait for the system to redirect you to the Log In screen. If the default NÜO Go! IP address has been changed, enter the new IP address in your browser.



This process may take a few seconds. If it takes more than one minute, press Go!

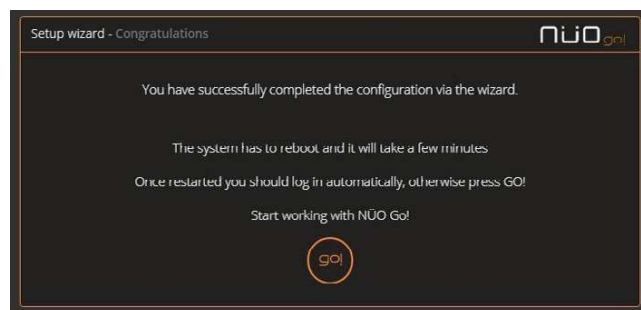

i If your equipment has already been set up, then the default password is **12345**

9. The system automatically starts to discover the installed On-line doors when you log on for the first time..

Operation >> NÜO Go!



5.1. FIRST STEPS: REGISTERING A USER

Follow these steps to set up your NÜO Go! To start registering users in the NÜO Go! System, the following fields should be set up beforehand. This is not essential and if you wish, the system will assign these values by default.

- Calendar and timetable: An Access group is assigned.
- Department
- Access group

5.1.1. Register users



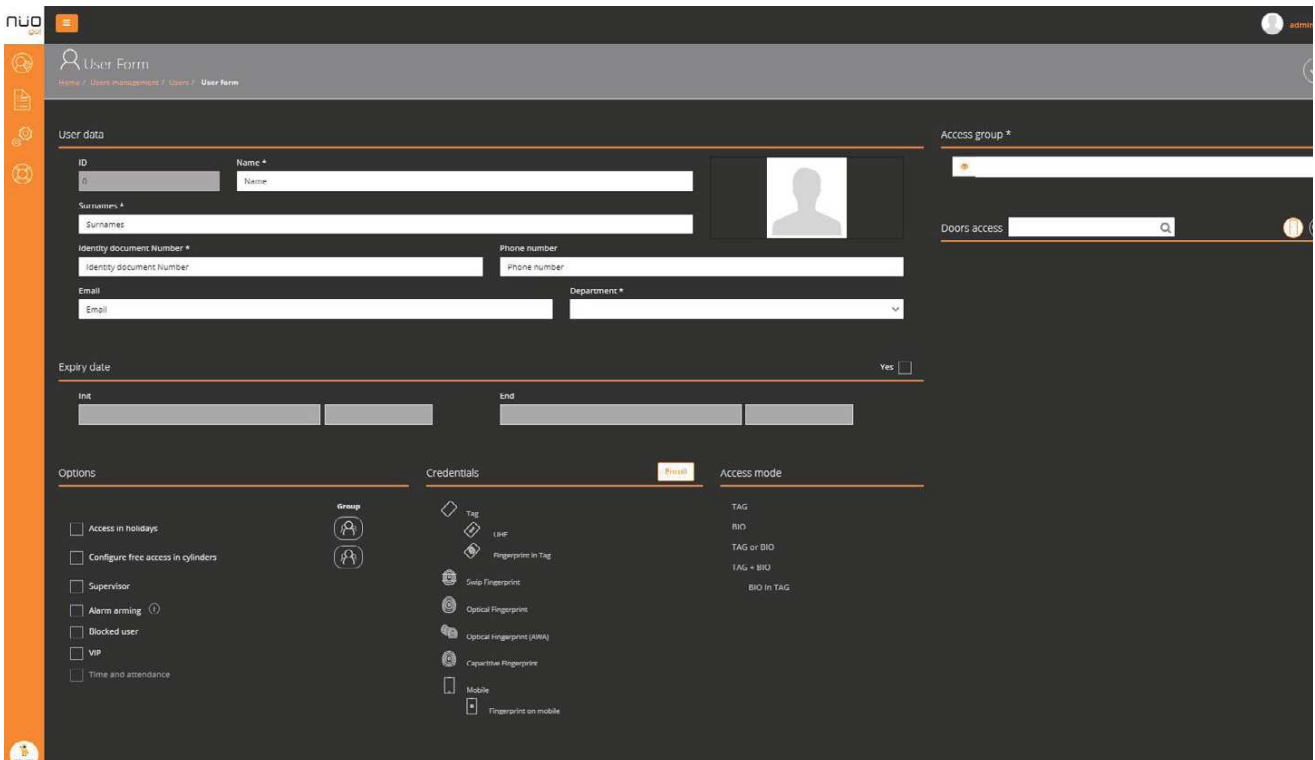

To start using NÜO Go!, try registering the first user at:

Home > User Management  > Users 

1. At Home > User Management > Users, select the New button 
2. Fill in the user's required data (name, surname(s) and ID).



Operation >> NÜO Go!







3. Assign a required Department to the user. Use the default Department if you have not created any departments (see Create Department section).
4. Assign a required Access group to the user. Use the default group if you have not created any groups (see Create Access group section).
5. Optional: assign the following fields: Telephone number, e-mail address, department, expiry date, user options, etc.
6. You can also register a user with the  button by following these steps.
7. Select the  button to save the changes.
 - Select  to edit an existing element. Select  to discard the changes.
 - Select  to delete an element.

> CALENDAR (HOME > USER MANAGEMENT  > TIMETABLES)

NÜO Go! has the flexibility to set up various timetables and calendars.





For example, calendars for different working days, access on holidays, weekends or 24 h for specific members, with/without summer working hours, etc.

To register a new calendar:

1. Go to Home > User management  > Calendars, and select the New button .
2. To enable help from the calendar configuration assistant, press **Yes** at the message saying *Would you like us to help you configure calendars?* and follow the steps given by the assistant.
3. Select the  button to save the changes.
 - Select  to edit an existing element. Select  to discard the changes.
 - Select  to delete an element.

> DEPARTMENT (HOME > USER MANAGEMENT  > DEPARTMENTS)

You can assign a department to each user. To register a new department:





1. Go to Home > User management > Departments, press the New button .
2. Enter the name of the department.
3. Select the  button to save the changes.
 - Select  to edit an existing element. Select  to discard the changes.
 - Select  to delete an element.

Operation >> NÜO Go!

> ACCESS GROUP (HOME > USER MANAGEMENT  > ACCESS GROUP)

The Access group option allows door groups to be created which can be assigned a permitted access timetable. Each user will have a group assigned to them, which then assigns the group features to the user, including the access timetable.

To register an Access group:

1. At Home > User management > Access group, select the button. 
2. Assign the Group a name.
3. Assign Access permissions on holidays if desired.
4. Select a Calendar (previously set up at Home > System settings > Calendars).
5. Select an Access method:
 - One identification options:
 - TAG: card
 - BIO: fingerprints
 - MOBILE: Card in smartphone.
 - Dual identification options:
 - TAG+BIO with option to save fingerprints in the card <BIO in TAG>.
 - MOBILE+BIO: fingerprint on mobile <Bio in Mobile>.
6. Select the  button to save changes.
 - Select  to edit an existing element. Select  to discard the changes.
 - Select  to delete an element.

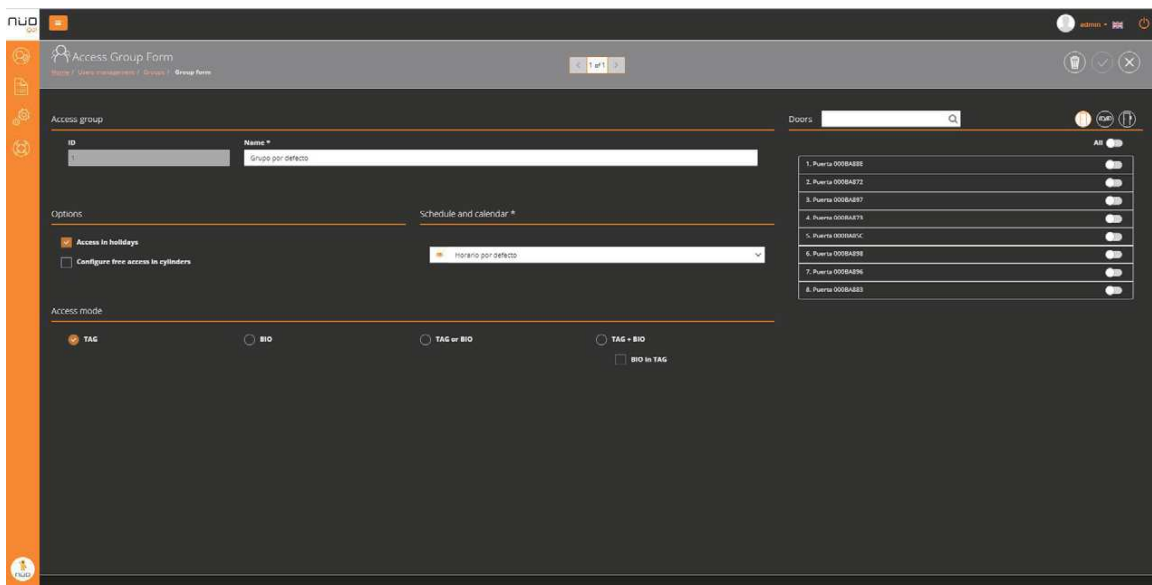



Operation >> NÜO Go!

5.2. FIRST STEPS - DOORS (ACTION AND SET UP).

5.2.1. Door status and actions

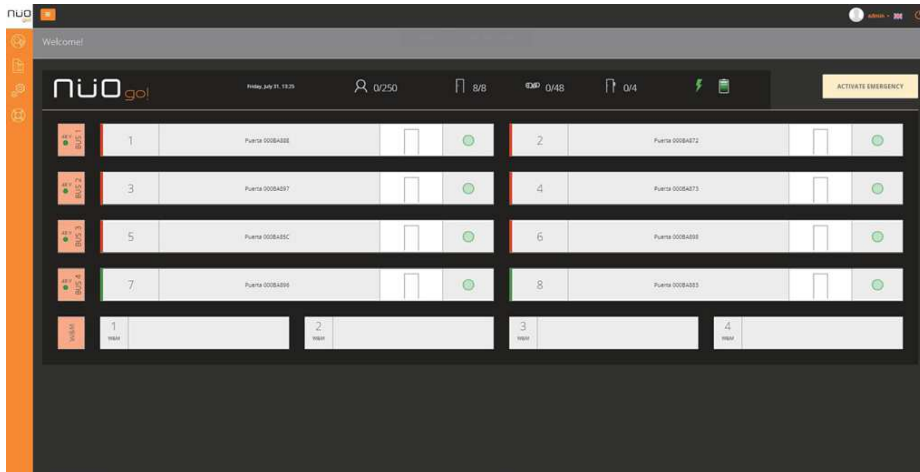
The information and actions for all doors are displayed on the NÜO Go! home page. To access the home page, select the  button in the upper left-hand corner of the screen.



The Home page has a “preview” of the doors and a Global Emergency Button  which can be used to put all installed emergency doors into an emergency status (the readers on these doors will flash green-orange).

Select the Global Emergency Button again if you would like to cancel the Global Emergency status. The reader light displays on emergency doors will then return to its normal status.

The icon  shows if the batteries are fully charged, charging or discharging or if there are no batteries connected to the installation. In case of a fault, it shows that the battery needs replacement with a similar icon to the one in the equipment display:



> View the door status

Select the  button in the upper left-hand corner to return to the Home page.

Each door has a button-tab with the name of the door in the middle:

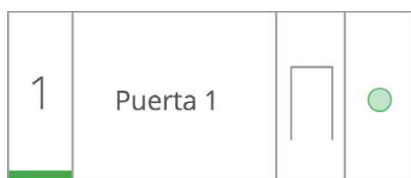

In the previous image, the green line underneath the number corresponding to each door indicates that it is open; the red line underneath the number corresponding to each door indicates that it is closed.

Operation >> NÜO Go!

>> **Actions involving doors.**

Open a door

1. Select the  button in the upper left-hand corner to go to the Dashboard.
2. The extended datasheet for each door is displayed when it is selected:

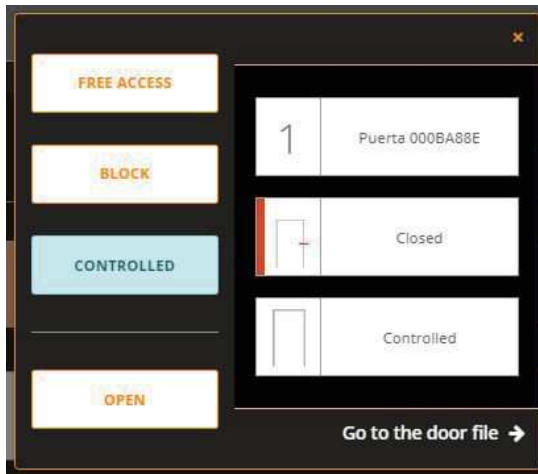

3. To open a door, select the OPEN button. The lock opens for the default duration of 3 seconds and later closes again. The user does not have to do any additional actions.

Block a door

Blocked means that no user can access the blocked door with their credentials.

1. Select the  button in the upper left-hand corner to go to the Dashboard.
2. The extended datasheet for each door is displayed when it is selected.
3. To block a door, select the BLOCK button.
4. The door remains blocked until the CONTROL button is selected.



Make a door Free Access

A door is made Free Access to allow users to pass through without showing any identification.

1. Select the  button in the upper left-hand corner to go to the Dashboard.
2. The extended datasheet for each door is displayed when it is selected.
3. To make a door unrestricted, select the UNRESTRICTED button.
4. The door remains Unrestricted until the CONTROL button is selected.

5.2.2. Set up an On-line door

Before beginning to use the system, it is important that the doors are suitably set up. You can view or modify the door options in the System settings menu .

1. Go to Home > System settings > Installation, and select the Doors button. 
2. Select the door to be changed and press 
3. Set the different door options.
4. Select the  button to save the changes.

The options that allow users to set up the doors are:

> **Change door type**

Change the type of doors to increase their security level.

There are several options:

- **Double intervention doors**

Door that are only accessible using credentials from two different configured users. Requires the presence of two registered users in order to gain access.

- **Supervisor doors**

Door only accessible to users that have presented suitable credentials in order to be set up as “supervisors” in the system.

The administrator sets a time in the application after which a supervisor’s credential will need to be validated again in order to activate access for other users.

If this is not set up then the default time is 00:00.

- **Armed Alarm doors**

A user set up with “Armed alarm” permissions may arm/disarm the alarm using a valid credential.

> **Programme door modes**

Programme Blocked door and/or Unrestricted door modes at different time throughout the week.

During unprogrammed hours and days, the door mode will be “CONTROLLED”.

> **Set up the door lock**

Set up the type of lock for the system according to the installation.

Select NO (Normally Open) or NC (Normally Closed) according to whether the lock needs a voltage supply for it to remain closed or open, respectively. Set the Lock activation time.



This is the time during which the lock function is unblocked after a user identifies himself or herself in the system to open the door and pass through. The default is 3 seconds.

> **Change door options**

Set up the doors so that they can take advantage of the various options offered by NÜO Go!

- **Emergency door**

A door that has been set up as an Emergency door is left unblocked (Unrestricted) for safety reasons when a local or general emergency is declared.

This status is displayed on the reader by a flashing green and orange light.

- **Door Open Alarm**

Set up an alarm that warns the user if a door has been left open after entering correctly.

The administrator can adjust the time period during which the door must remain open for the alarm to be raised.

- **Forced Door Alarm**

Set up an alarm in the system that warns the user if a door has been forced open.

- **Airlock**

Set up an airlock in NÜO One by selecting Airlock for the desired group of doors.

> **Reader configuration**

The system does not distinguish between a reader installed on a door exit and a reader installed at the entrance. You may change the order in this section.

Supervisor and Armed Alarm doors must have a reader set up as an auxiliary reader where the supervisor or user arming the door can be identified.

A Supervisor door must also have an entrance reader so that the remaining users can enter by showing their credential. Exit is unrestricted (a Supervisor does not need to be present at the auxiliary reader in order for the users to exit).

> **SDU+/Wili+ inputs and outputs**

You can set up 2 digital inputs and 2 output relays for the SDU+ and Wili+ using the different options offered by NÜO Go! as required.

> **Door status and actions**

The Open/Closed door status can be viewed and the Unrestricted/Block/Open actions can also be carried out from the door datasheets.

5.2.3. Set up an Off-line door

You can set up a maximum of 48 Offline Doors in your NÜO Go! system by importing the file provided by By that contains all the data required on the installation cylinders.

Go to the System Settings menu > Installation > Doors, select the Offline Doors option and select Discover. A window will appear with all the Offline doors in this file. Select all the doors that you want to add to the installation.

To complete the operation, select the Discover doors option.

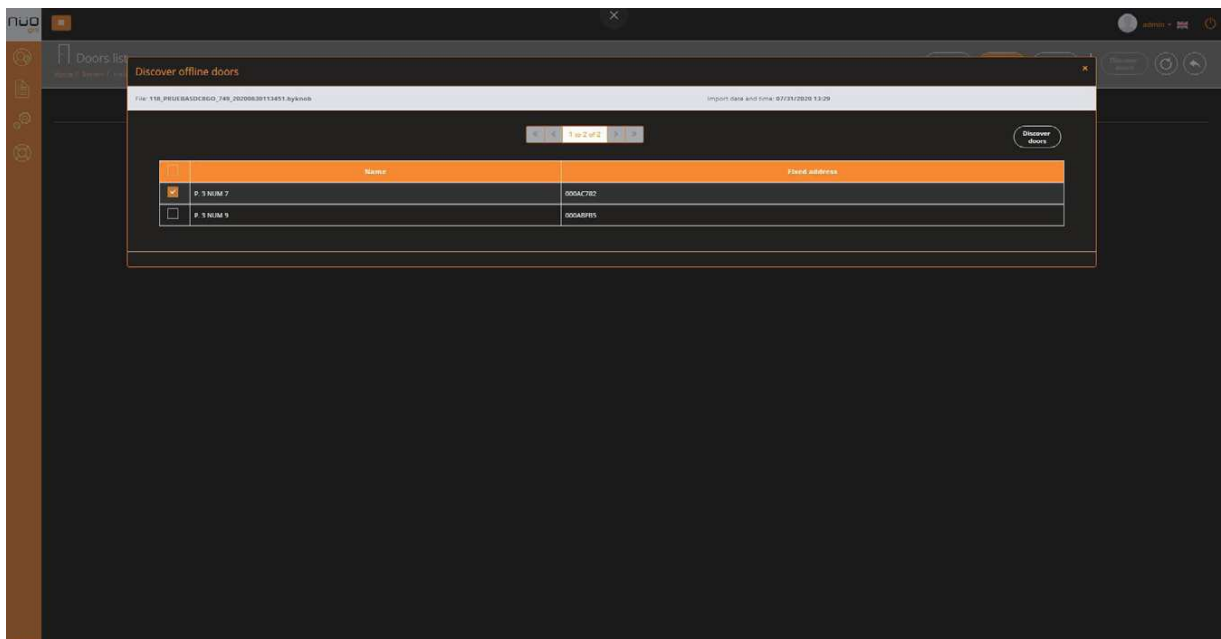

5.2.4. Set up an Console

You can set up up to 4 consoles in your NÜO Go system! in the Consoles option in the menu System> Installation> Consoles. Previously you must have configured the network parameters of the consoles, if not, go to point 6.1 Console Settings.

To discover the consoles press discover consoles . The configured consoles will appear. Select the consoles that you want to add to the system and press accept.

5.2.5. Set up a Video-intercom door

You can set up to 4 doors with video-intercom in the NÜO Go! system by selecting the Video-intercom Doors option  from the menu System > Installation > Doors. Previously you must have configured the network parameters of the video intercoms, if not, redirect to point 6.2 Voxter / Voxter Sky video-intercoms settings.

Operation >> NÜO Go!

To discover the doors with video intercommunication press discover doors  The doors with videointercommunications configured will appear. Select the doors you want to add to the system and press accept.

You can edit specific aspects of the intercom system from the Video-intercom Door data sheet such as assigning calls to consoles or changing the warning sounds, in addition to accessing all the options available for an On-Line door (they can also have readers connected to them).

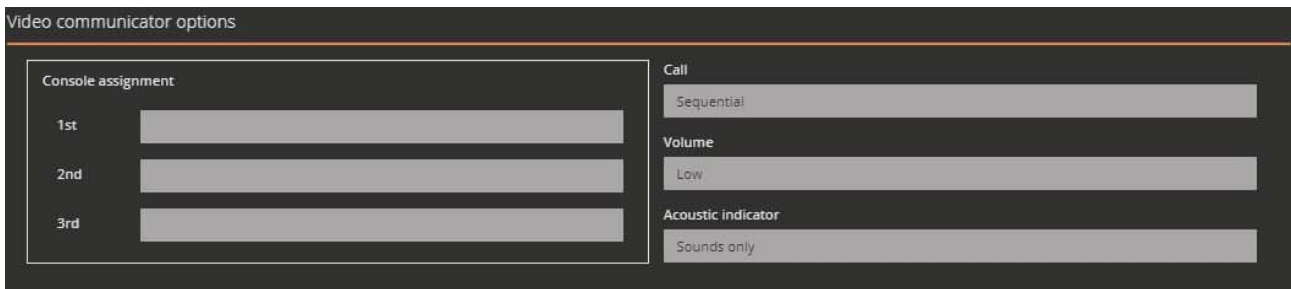

Set up warnings

If any of the wiring is changed, i.e. if it is connected to a terminal block other than the original terminal block, all the doors must be removed from this terminal from the application and they will then need to be discovered again.

5.2.6. Set up the lighting colours of NÜO Sky

From the door form where Position and Lighting modules are detected, you can perform the following actions:

- Select the colour of the Position module: Blue, Turquoise, Violet, Yellow, Magenta
- Select the colour of the Lighting module: Blue, Turquoise, Violet, Yellow, Magenta or White

If a door has both modules, the Lighting module can only be set to the same color as the Position one or to white.

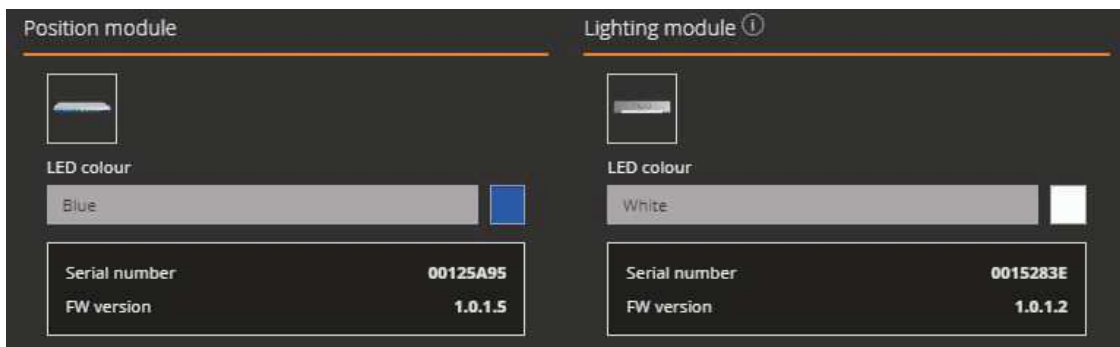



5.3. REPORTS

NÜO Go! can view and export reports on general system, door and user records and incidents.

Access the various types of reports at Home >  Reports.

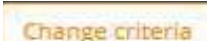

> Report by user

Access records and incidents associated with a user (granted entry/exit, access denied due to timetable, etc.).

1. At Home > Reports, select the  button.
2. Select the name of the user or enter the user's ID. If you would like to see all Access Records, do not change this field.
3. Select a range of dates to filter the records.
4. You may optionally select a door and/or specific type of incident.
5. Select the button  to prepare the report.
6. Select  to modify the filters.

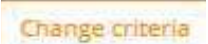

> Report by door

Access records and incidents associated with a door (e.g. different users that have passed through a certain door, access denied due to unknown fingerprint).

1. At Home > Reports, select the  button
2. Choose the door that you would like the report for.
3. Select a range of dates to filter the records.
4. You may optionally select a user, a department and/or specific type of incident.
5. Select the  button to prepare the report.
6. Select  to modify the filters.

> System report

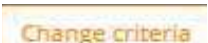

System records (e.g. terminal connections/disconnections).

1. At Home > Reports, select the  button.
2. Select a range of dates to filter the records.
3. You may optionally select a door, a terminal and/or specific type of incident.
4. Select the  button to prepare the report.
5. Select  to modify the filters.



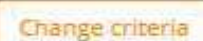

> Report by department

Access records and incidents for an entire department.

1. At Home > Reports, select the  button.
2. Choose the department that you would like the report for. If you would like to see all Access Records, do not change this field.
3. Select a range of dates to filter the records.
4. You may optionally select a door and/or specific type of incident.
5. Select the  button to prepare the report.
6. Select  to modify the filters.

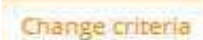

> Alarm report

Filters alarm incidents (e.g. time and door related to an alarm)/

1. At Home > Reports, select the  button.
2. Choose the type of incident that you would like the report for.
3. Select a range of dates to filter the records.
4. You may optionally select a user, a door and/or specific department.
5. Select the  button to prepare the report.
6. Select  to modify the filters.

> Report by action

Filters action incidents (e.g. time and door push button was activated to exit).

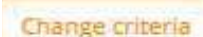
1. At Home > Reports, select the  button.
2. Choose the type of incident that you would like the report for.
3. Select a range of dates to filter the records.
4. You may optionally select a door and/or specific department.
5. Select the  button to prepare the report.
6. Select  to modify the filters.



> **User list**

List of users with various filters (e.g. expired, blocked, which have access to a specific door, etc.). The different filters possible are:

1. List of users who have access to a door. Select a specific door and press View report.
2. List of doors which the user has access to. Select a specific user and press View report.
3. List of users according to options. Select whether you want a list of the users with Access on holidays or users who are Supervisors, Armed alarm, or blocked users, and press View report.
4. List of expired users. Select whether you want to see only expired users or current users and press View report.
5. List of users according to credentials. Select the type of credential and press View report to list all users registered with a certain type of credential.
6. List of users according to access method. Select the type of access method and press View report to list all users with a certain access method assigned to them.
7. List of users according to access group. Select the type of access group and press View report to list all users who belong to a specific access group..

> **Technical report**

Filters all incidents.

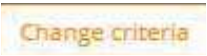
1. At Home > Reports, select the  button.
2. Select a range of dates to filter the records.
3. You may optionally select filters.
4. Select the  button to prepare the report.
5. Select  to modify the filters.

5.4. MORE SYSTEM OPTIONS

You can view or modify the components installed in the system through the System settings menu 

> **Set up doors** (See [section 5.2.2 Set up a door](#))

> **View reader features**

Press the System settings button  > Installation  > Readers 

The readers installed are classified according to the door on which they are installed.

You can activate a reader's sound and light-based signals using the Signal button .

You can view the type, serial number, firmware, status and position of the reader (entrance, exit, auxiliary)..

> **View controller features**

Press the System settings button  > Installation  > Controller 

The devices installed, their type, serial number, firmware and status will be displayed.

You can locate the device using the Signal button .

> **Console settings**

Press the System button  > Installation  > Consoles 

The installed consoles will appear, where you can check the type, serial number, firmware, MAC address and status.



You can locate the device using the Signal button .

Press the Discover button to add more consoles to the system.



Press on each console to access the console Data sheet in order to edit the characteristics and view the network parameters.

> **Set up calendars** ([See section 5.1.1 First steps user register](#))



> **Change date and time**

Select the System settings button  > System  > Date and time 
Set the system date, time and time zone.



> **Change language**

Select the System settings button  > System  > Language  .
Set the system language.



> **Import/export a back-up copy.**

Select the System settings button  > System  > Back-up copy  to export a back-up copy of the system's current status or to import a back-up copy that has previously been created.

> **Change password**

Select the System settings button  > System  > Change password  to change the password used to access the application.

> **Change network configuration**

Select the System settings button  > System  > network  to change the TCP/IP network connection configuration. (See the Network Configuration step in the NÜO Go! initial set up).

> **Update Firmware**

Select the System settings button  > System  > Update Firmware  to update the Firmware on various system devices.

Diagrams >> NÜO DC Go! 8

6. DIAGRAMS

6.1. CONNECTION TO NÜO DC GO! 8

6.1.1. CONNECTION FROM THE SDU DOOR UNITS TO NÜO DC GO! 8

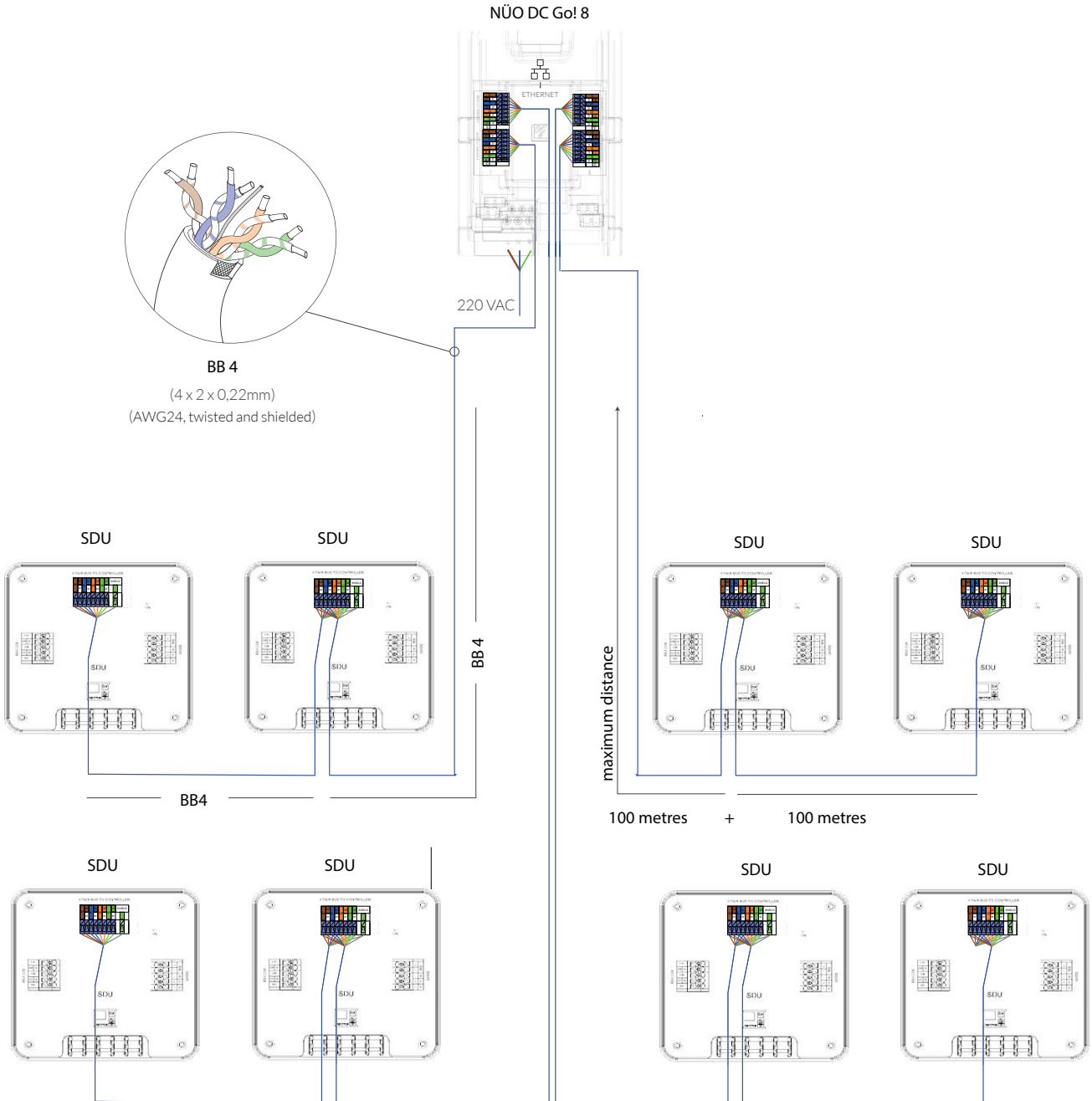

Connect up to two SDU per Bus as shown in the diagram, using no more than 100 metres of cable to the first SDU and 100 metres to the second.



Do not open the cover without disconnecting the equipment from the main power supply. Disconnect the equipment from the main power supply and it will continue to operate on battery power (provided you have configured the doors in the app). In this case, make sure you disconnect the batteries (See “Step 8. Disconnecting the Batteries” in section 3.1 NÜO DC GO! 8 DISPLAY).

6.1.2. NÜO SDU AND SDU+ TO NÜO DC GO! 8 CONNECTION

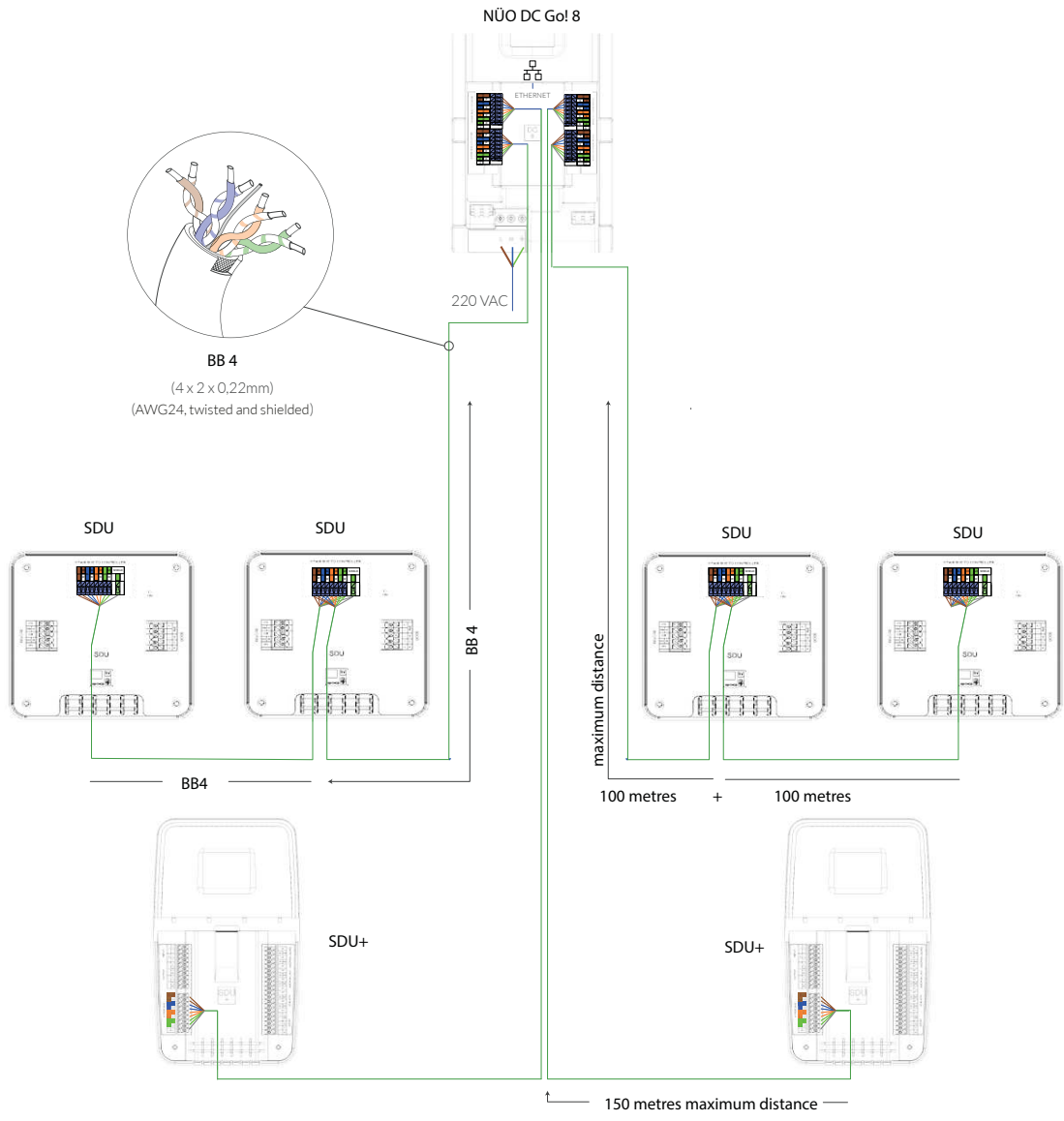

Connect up to two SDU per bus or an SDU+, using no more than 150 metres of cable in case of connecting an SDU+.



Do not open the cover without disconnecting the equipment from the main power supply. Disconnect the equipment from the main power supply and it will continue to operate on battery power (provided you have configured the doors in the app). In this case, make sure you disconnect the batteries (See “Step 8. Disconnecting the Batteries” in section 3.1 NÜO DC GO! 8 DISPLAY).



6.1.3.DETAIL OF THE CONNECTION SDU/SDU+ TO NÜO DC GO!8

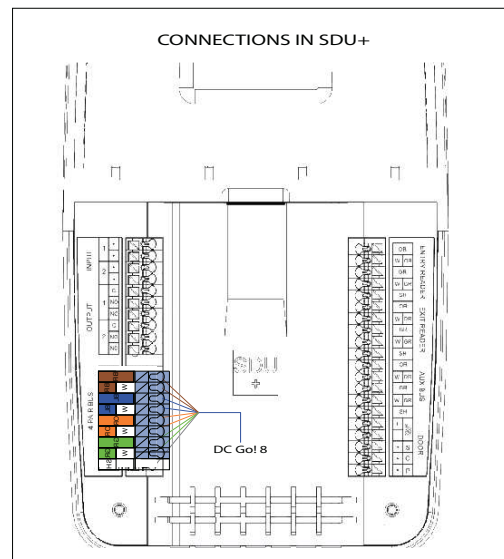
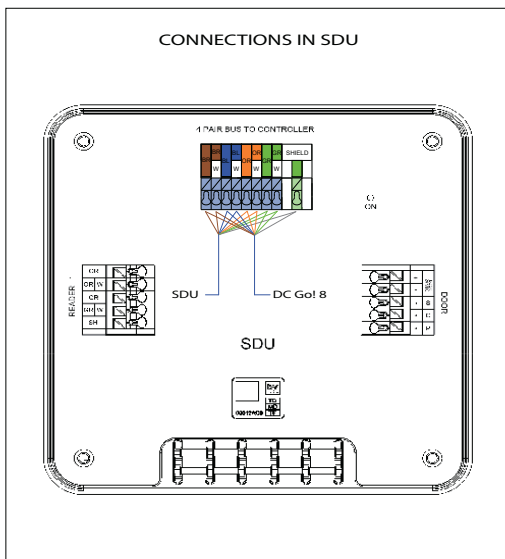
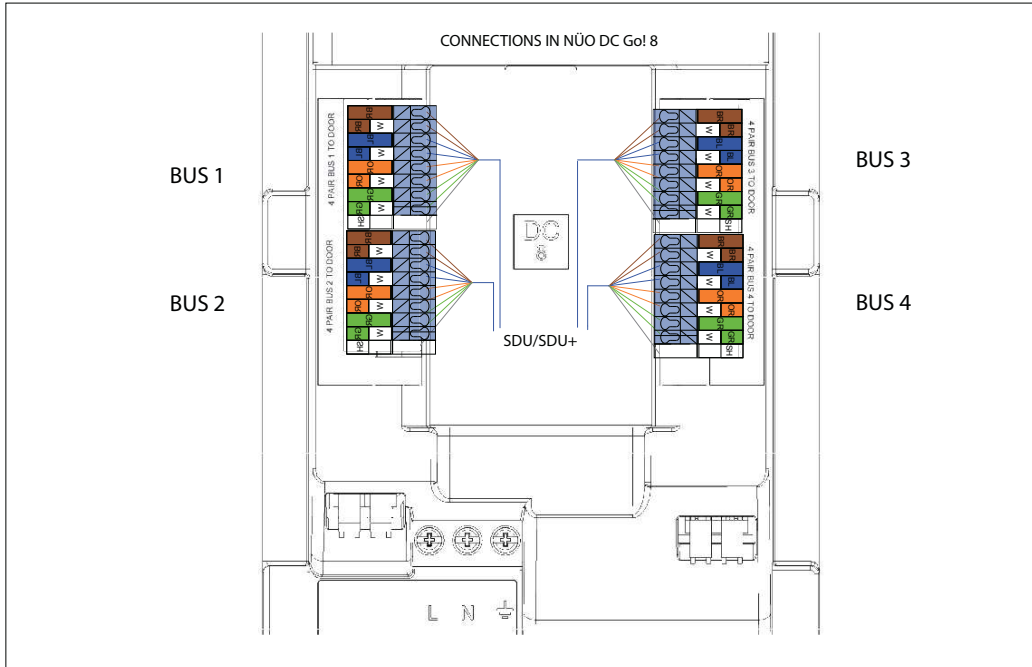

The use of incorrect wiring can damage the equipment irreversibly.



Connect up to two SDU per bus or an SDU+ as shown by the images above.



Do not open the cover without disconnecting the equipment from the main power supply. Disconnect the equipment from the main power supply and it will continue to operate on battery power (provided you have configured the doors in the app). In this case, make sure you disconnect the batteries (See “Step 8. Disconnecting the Batteries” in section 3.1 NÜO DC GO! 8 DISPLAY).

6.1.4. DIAGRAM CONNECTION OF THE ELEMENTS OF A DOOR WITH SDU

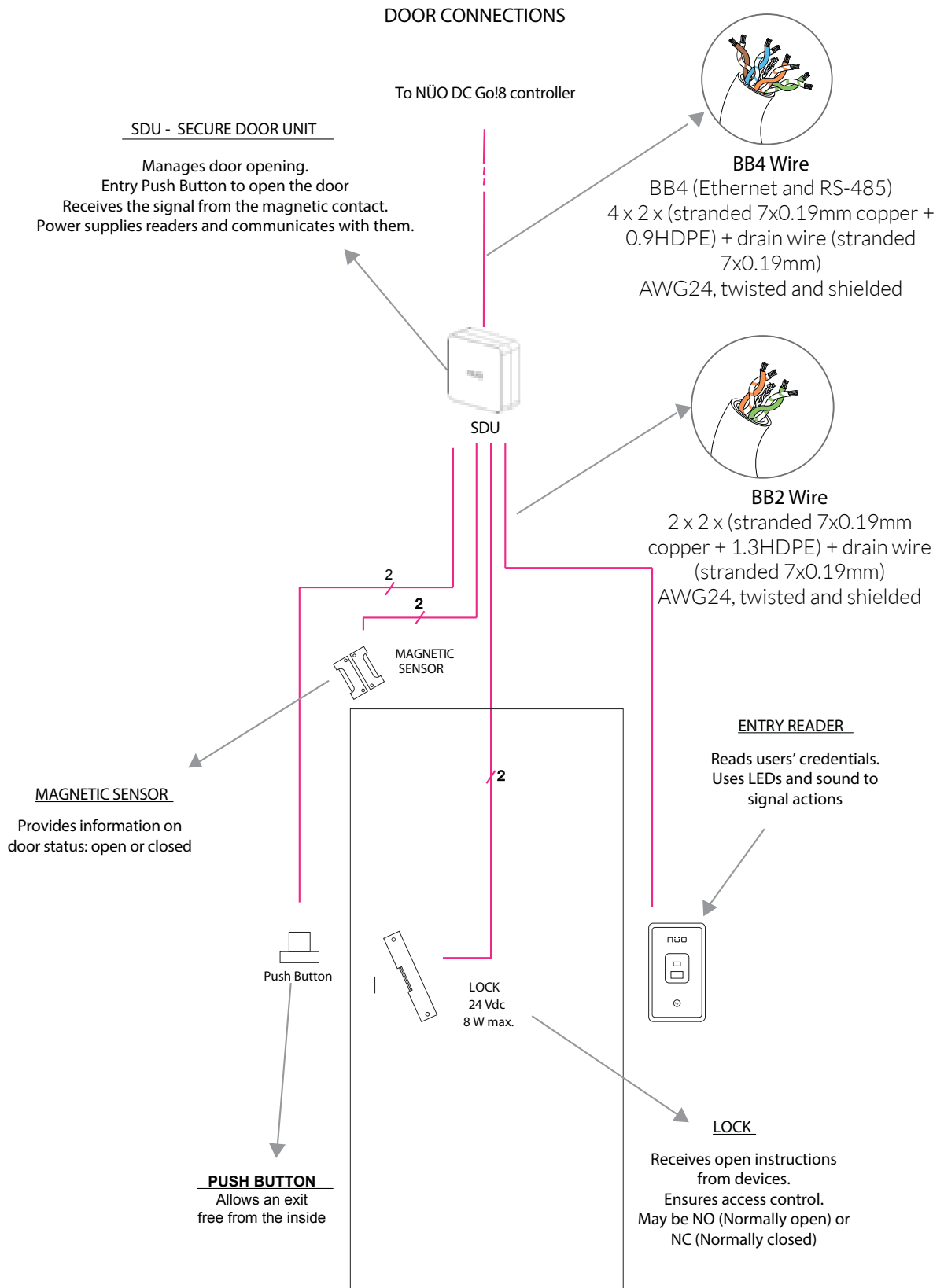

6.1.5. DETAILED DIAGRAM SDU CONNECTION

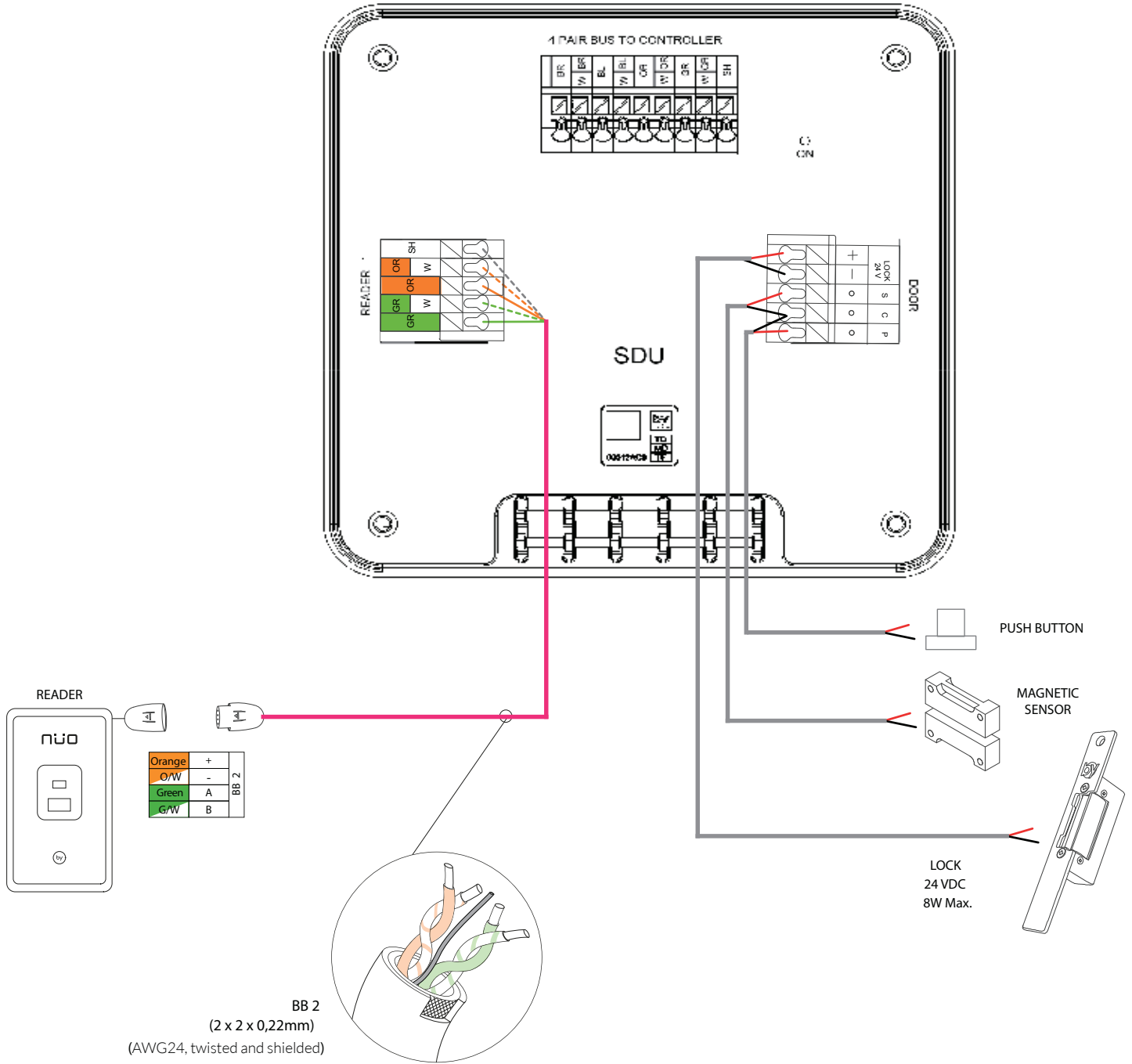

At least one reader should be connected to the door or it must to be a Face Reader connected or it should be set up as an emergency door

The use of incorrect wiring can damage the equipment irreversibly.

Reader maximun consumption 7W

Diagrams >> NÜO DC Go! 8 >

6.1.6. DIAGRAM CONNECTION OF THE ELEMENTS OF A DOOR WITH SDU+

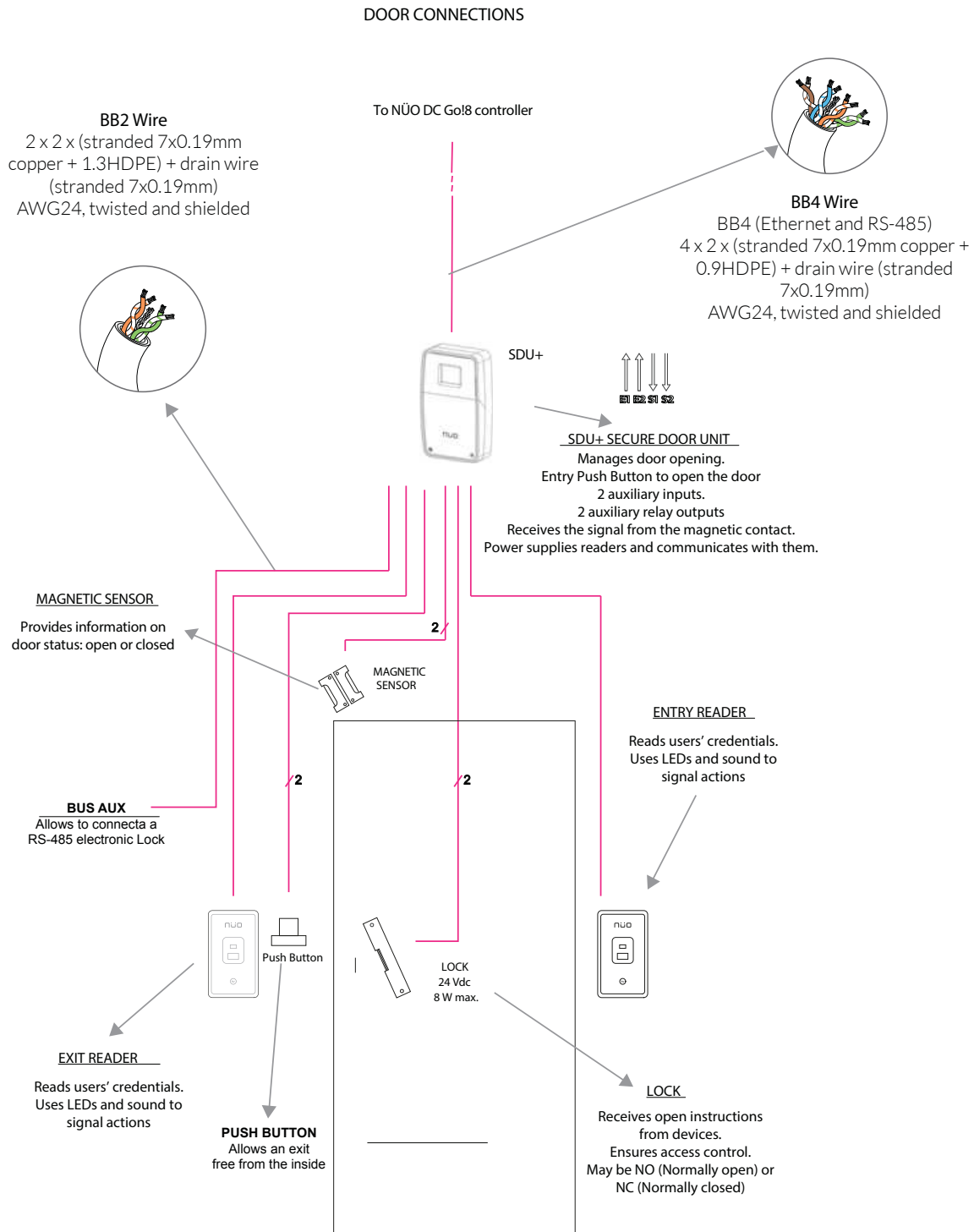

6.1.7. DETAILED DIAGRAM SDU+ CONNECTION

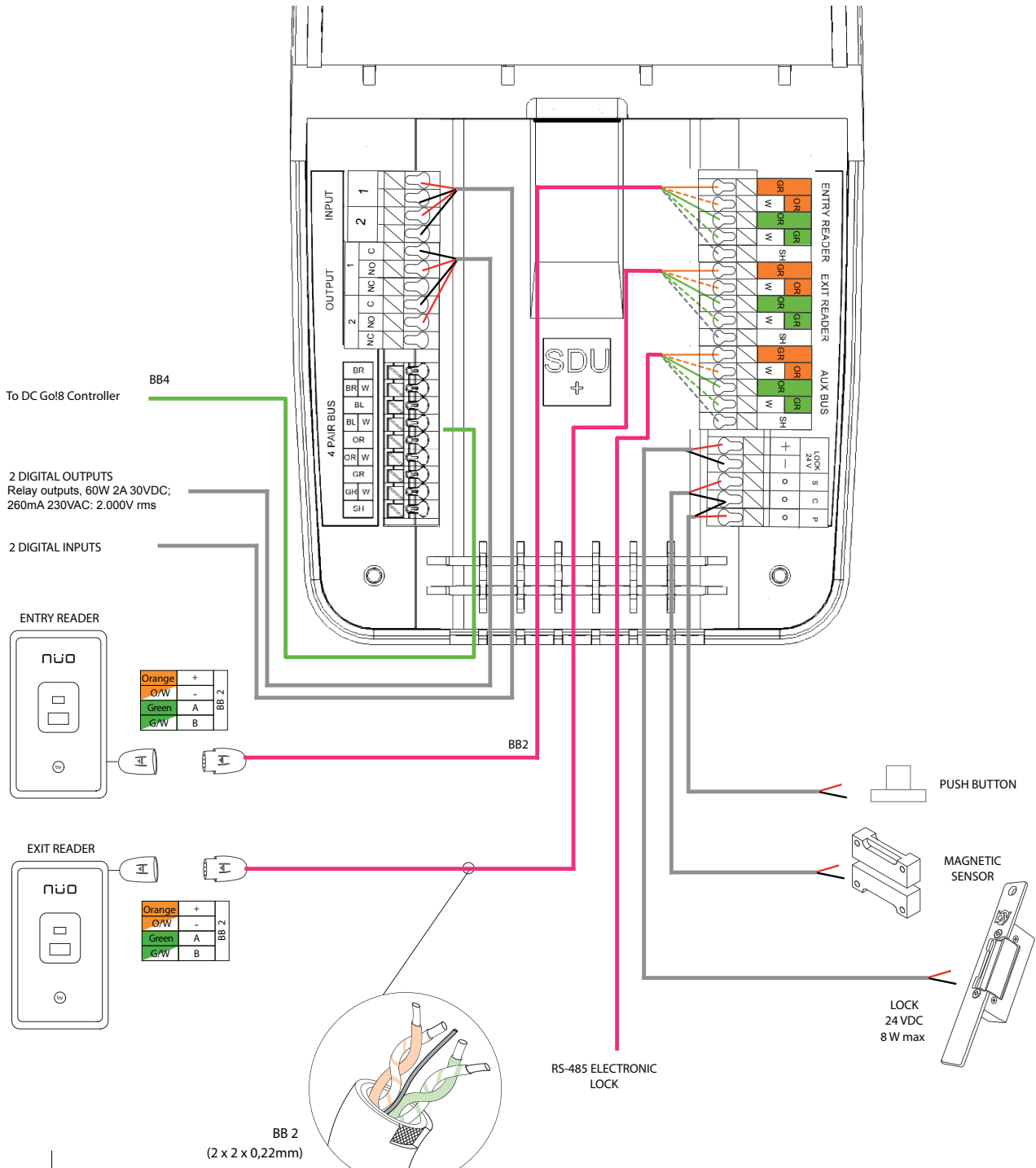

The 24VDC "Lock" can be connected at the same time as the Auxiliary Bus, delivering it at most 12W, but the sum of both must be \leq at 12W)

At least one reader should be connected to the door or it must to be a Face Reader connected or it should be set up as an emergency door.

The use of incorrect wiring can damage the equipment irreversibly.

6.2. VIDEO-INTERCOM CONNECTION TO WILI/WILI+

6.2.1. VIDEO-INTERCOM CONNECTION VOXTER TO WILI

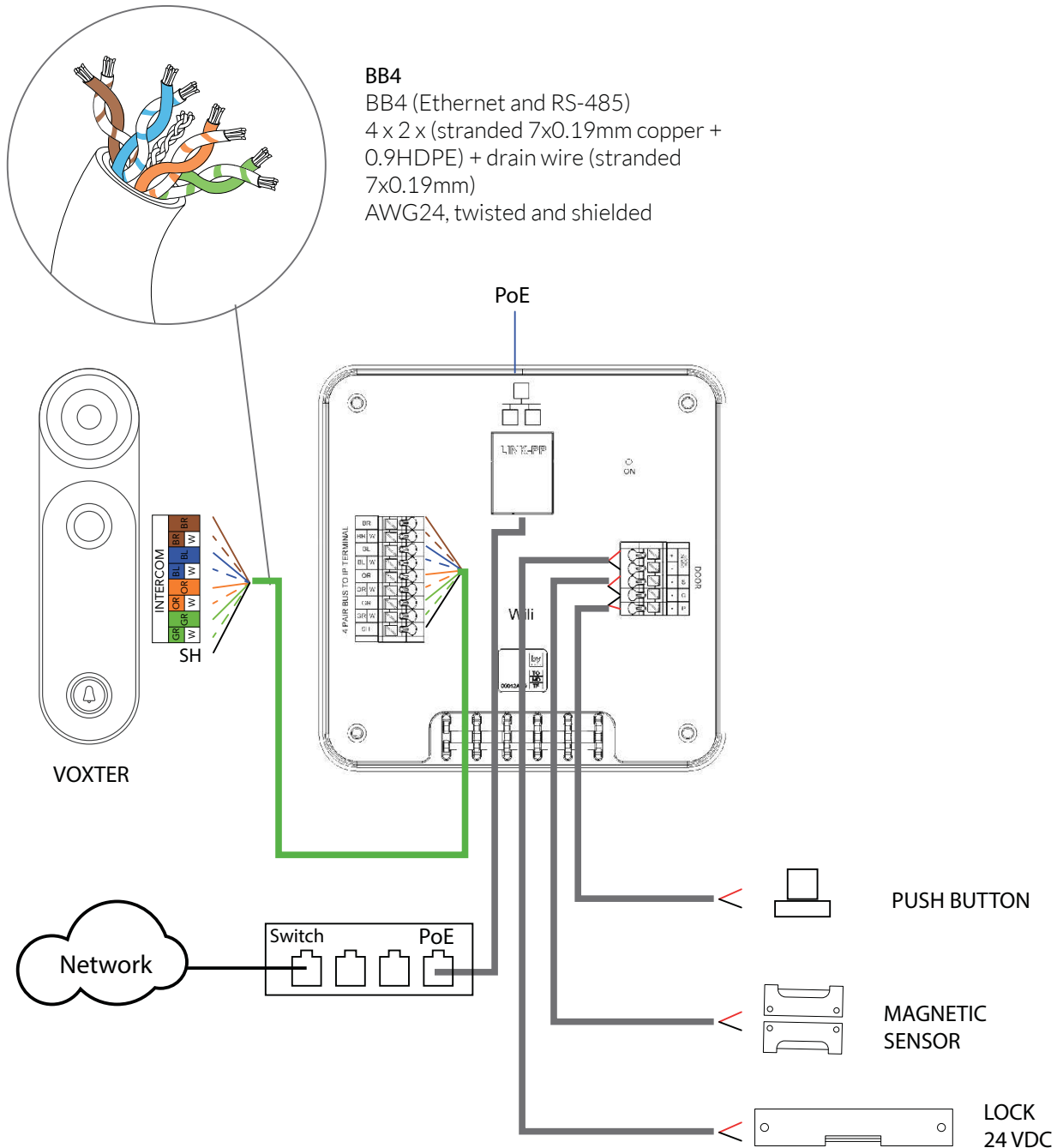

The use of incorrect wiring can damage the equipment irreversibly.

6.2.2.VOXTER AND READERS CONNECTION TO WILI+

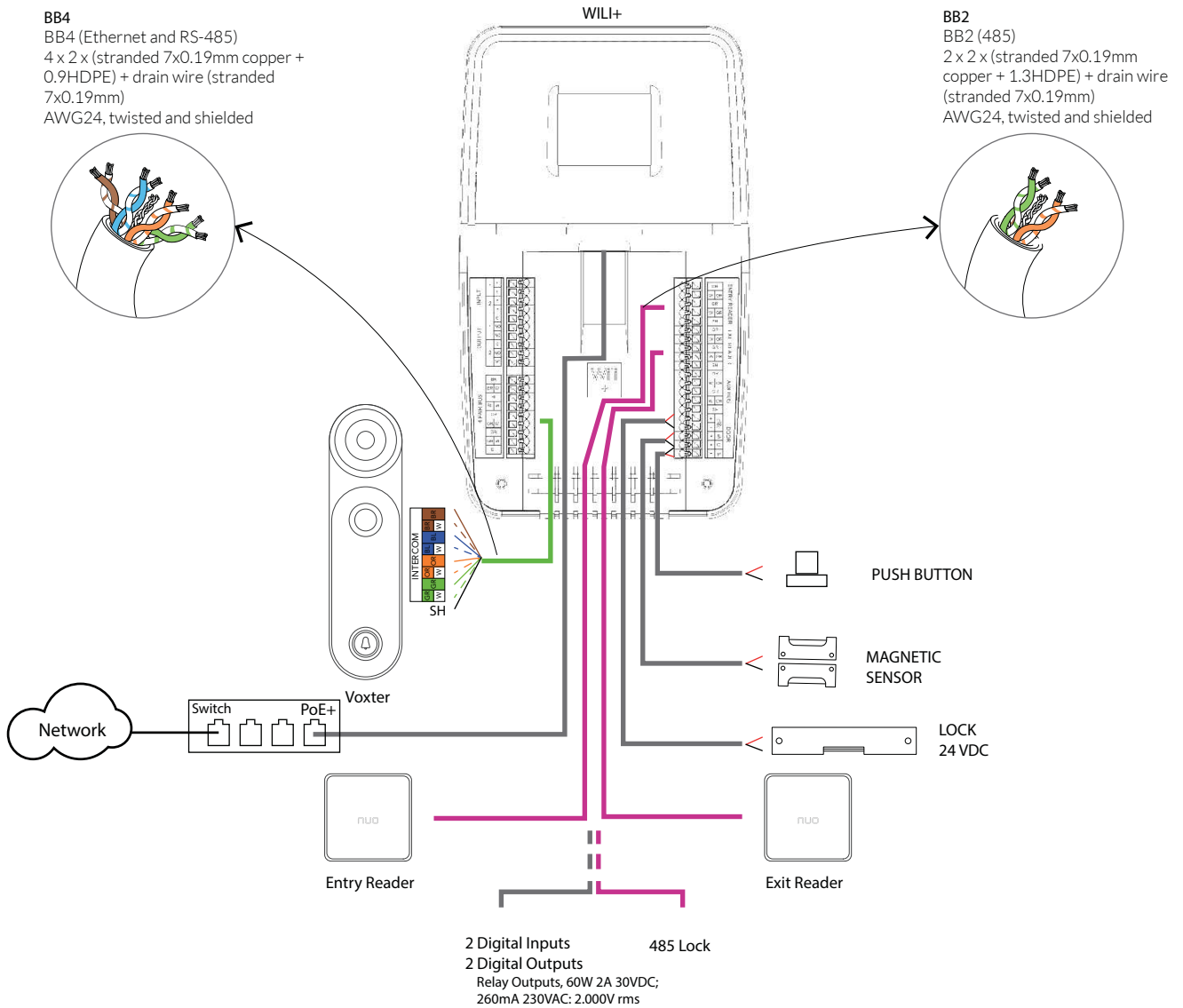

LOCK OUTPUT:



Lock 24VDC, 8W Max

*It cannot be connected at the same time as the Auxiliary Bus or it cannot exceed the sum of 10W between both of them)



The use of incorrect wiring can damage the equipment irreversibly.

6.2.3. CONNECTION FROM SKY FLUX/SURF SUPPORT TO WILI+

DOOR WITH VIDEOINTERCOMMUNICATION (W&M) Sky Flux/Surf bracket and Sky Mini post

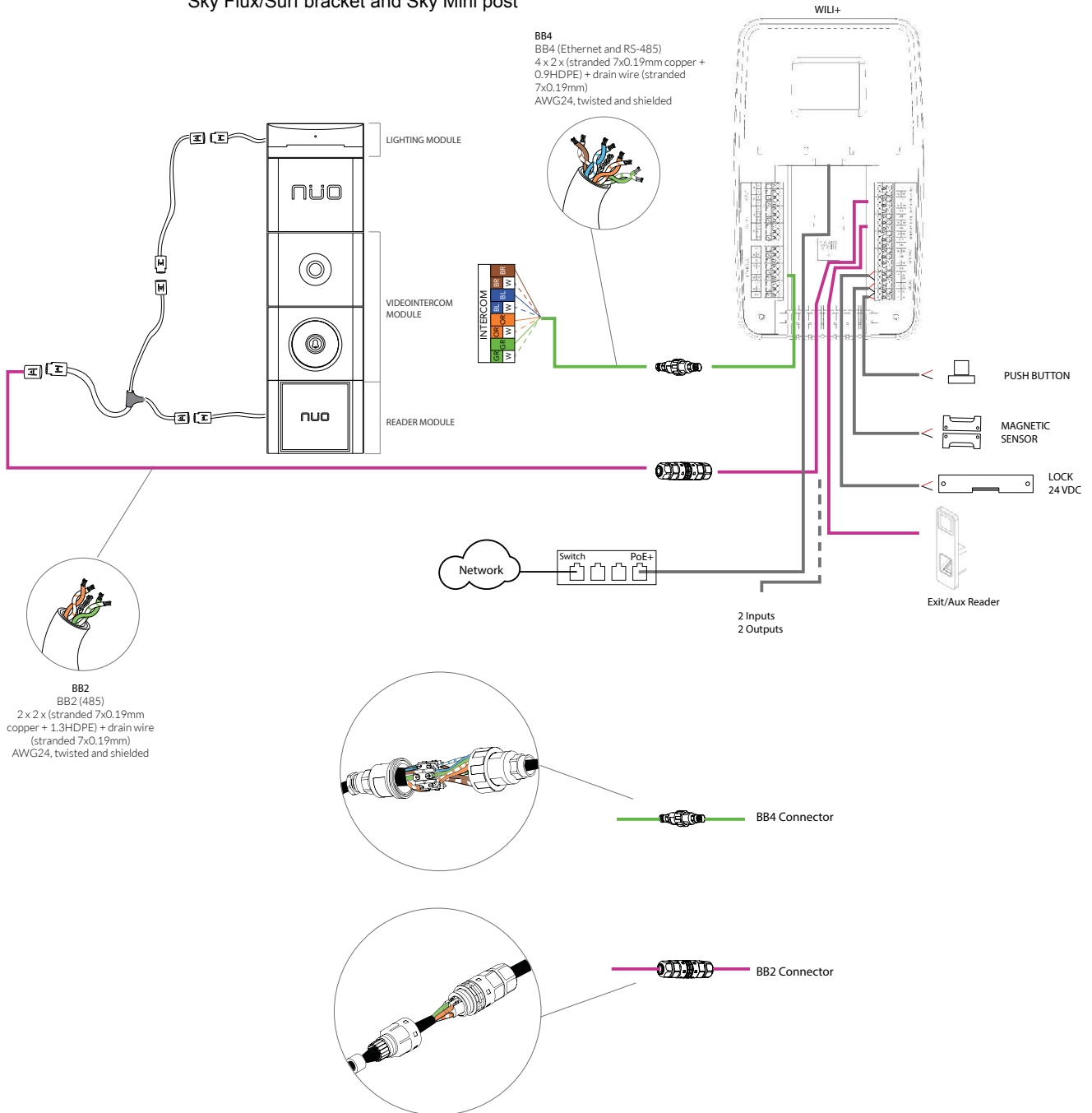

The use of incorrect wiring can damage the equipment irreversibly.

For this configuration, with two readers, the use of an external power supply for the Lock 24 VDC lock is recommended.

6.2.4. CONNECTION OF SKY POST

DOOR WITH VIDEOINTERCOMMUNICATION (W&M) Sky post

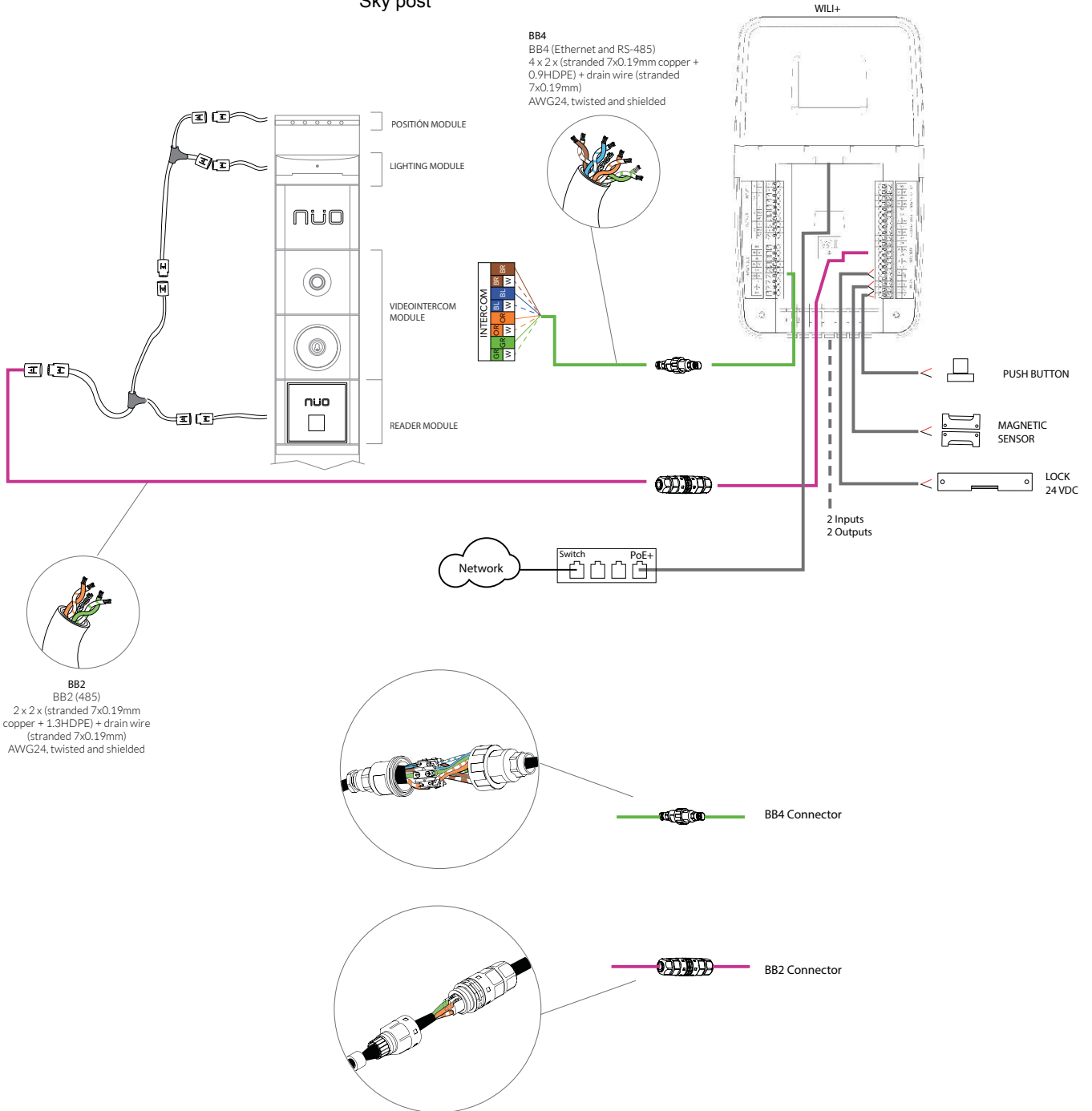

The use of incorrect wiring can damage the equipment irreversibly.
For this configuration it is recommended to use the Lock 24 VDC. 4W lock.

Diagrams NÜO DC Go! 8

6.2.5. CONNECTION OF SKY CAR POST/WALK WITH WILI+

DOOR WITH VIDEOINTERCOMMUNICATION AND UHF READER(W&M)
NÜO Sky Car/Walk

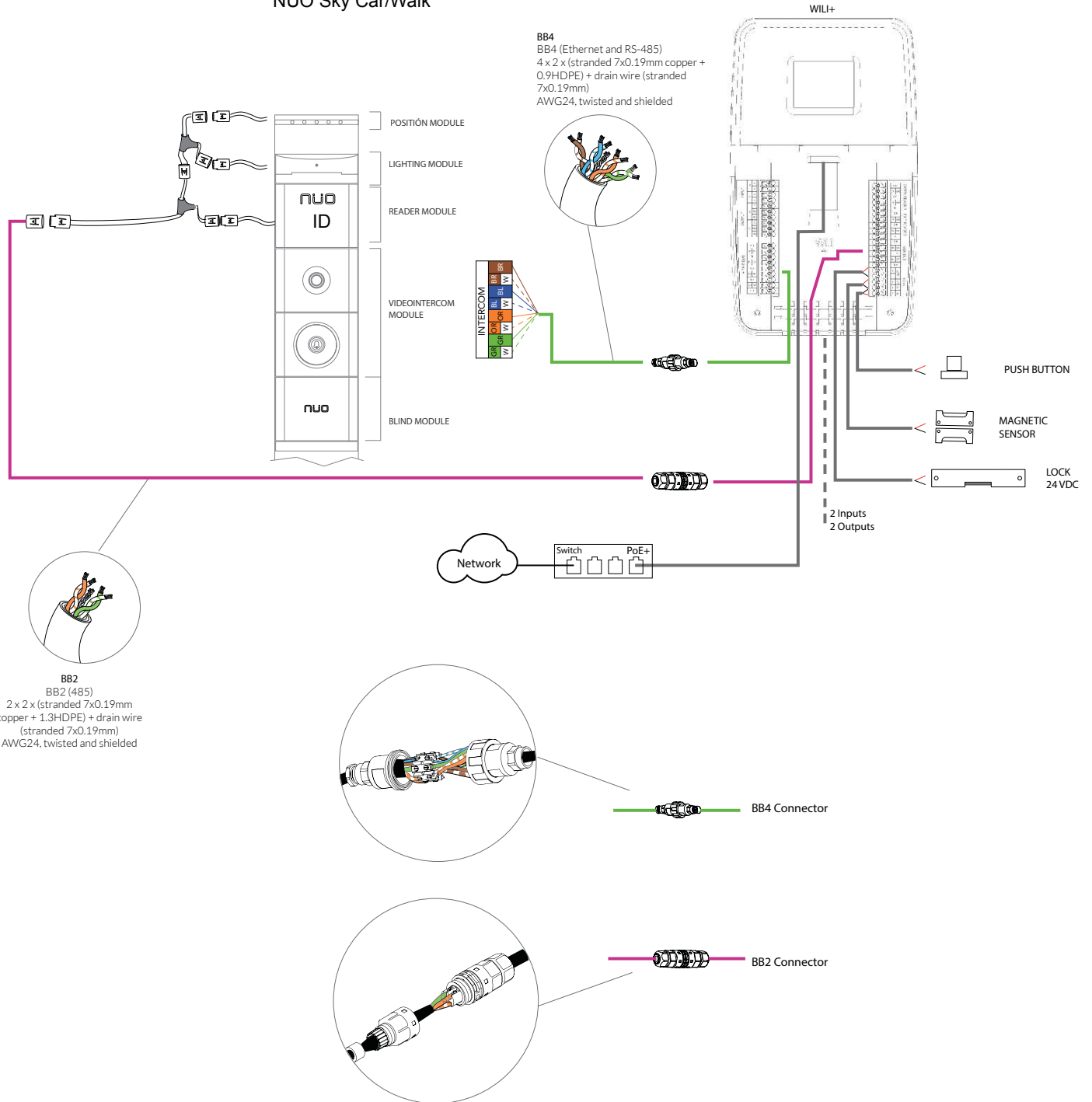

The use of incorrect wiring can damage the equipment irreversibly.
For this configuration it is recommended to use the Lock 24 VDC. 5W lock.

6.3. W&M CONNECTION TO POE SWITCH

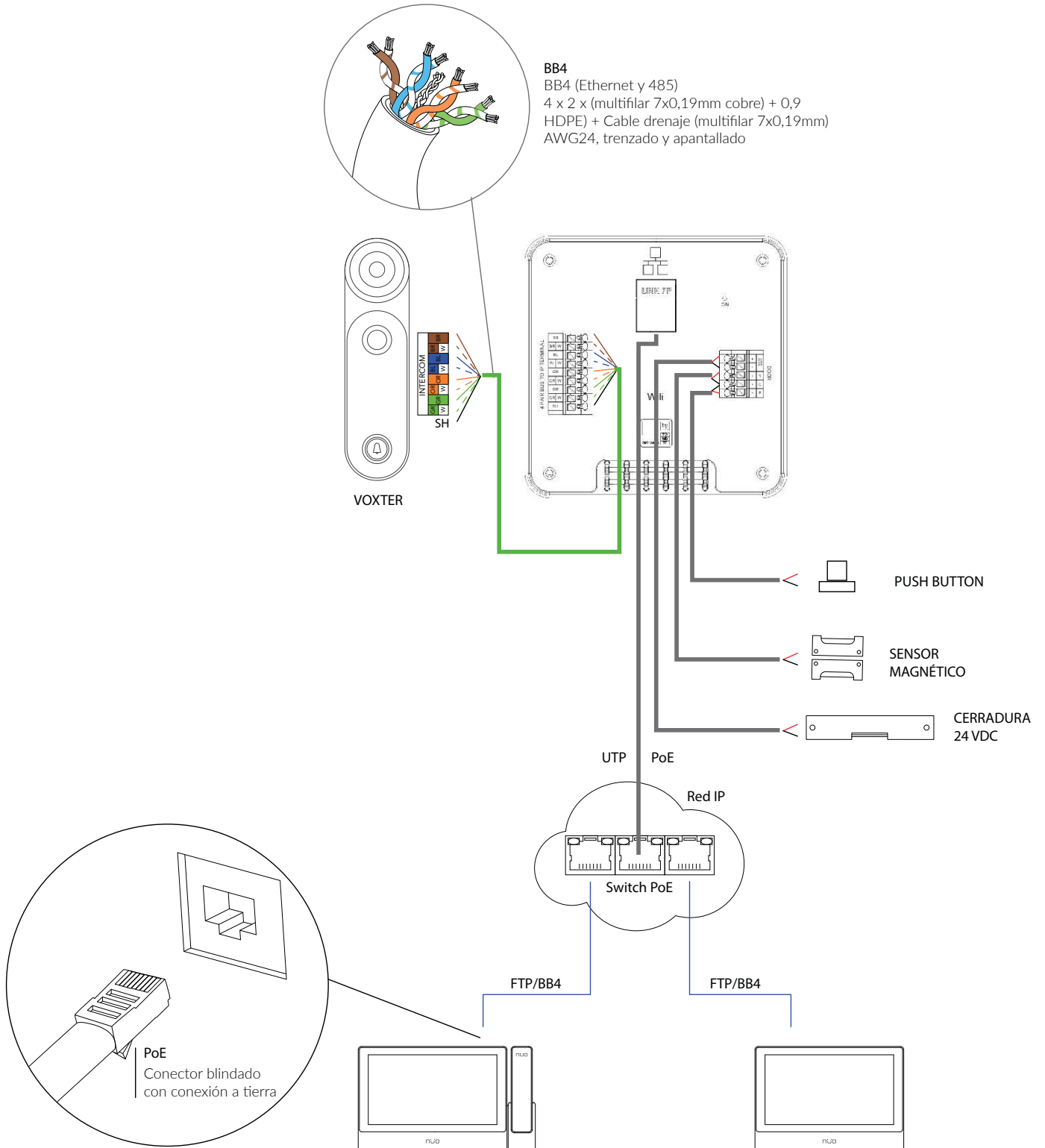

The video-console wiring must be earthed and the connector must be shielded or twisted.



7. Information regarding the NÜO DC Go! product

Indoor installation:



This product is an indoor product and does not require any maintenance to be done on live or open components.

Battery life:

Doors formed with SDU: 4 hours for 4 doors, 2.5 hours for 8 doors.
Doors formed with SDU+: 4 hours for 3 doors, 3 hours for 4 doors.

RF Frequency range and max output power

BT: 2.4-2.5GHz.
MAX OUTPUT: AIR: 0.39dBm(1.09mW) ; Polo: 6.31dBm(4.3mW) ; Golf: 1.09dBm(1.3mW)
NFC: 13.56 MHz

Altitude height

2000mtrs (Above 2000m, rise 100m, Environment temperature decrease 0.6°C)

Cross-Device and browsers supported:

The Nüo Go! App has a responsive interface for Desktop computers (Full HD) and Tablet (12.9" and 9,7").

- WINDOWS: Internet Explorer 11; Microsoft Edge ; Chrome 83 (or higher) ; Firefox 77 (or higher)
- MAC: Safari 10 (or higher)
- iPad Pro 12.9": IOS 9.3.2 : Mobile Safari 9
- Android devices: Android 5.0: Chrome for Android 43 (or higher) and Firefox for Android.

Firmware version:

NÜO DC Go! 8 Controller	v2.1.63 (or higher)
NÜO SDU · Door Unit	1.0.29 (or higher)
NÜO SDU+ · Door Unit	1.0.2 (or higher)
NÜO WILI · Door Unit	1.0.24 (or higher)
NÜO WILI+ · Door Unit	1.0.5 (or higher)
W&M Viderointercom equipments	5.13.352 (or higher)
NÜO RUN	0.0.5 (or higher)
NÜO AIR	0.0.5 (or higher)
NÜO POLO	2.0.5 (or higher)
NÜO GOLF	2.0.5 (or higher)



8. Warnings

FCC:

This equipment has been tested and found to comply with the limits for a Class B digital device, pursuant to Part 15 of the FCC Rules. These limits are designed to provide reasonable protection against harmful interference in a residential installation.

This equipment generates, uses and can radiate radio frequency energy. However, there is no guarantee that interference will not occur in a particular installation. If this equipment does cause harmful interference to radio or reception, which can be determined by turning the equipment off and on, the user is encouraged to try to correct the interference by one or more of the following measures:

- Reorient or relocate the receiving antenna.
- Increase the separation between the equipment and receiver.
- Connect the equipment into an outlet on a circuit different from that to which the receiver is connected.
- Consult the dealer or an experienced technician for help.

This device complies with part 15 of the FCC Rules. Operation is subject to the following two conditions:

- 1) This device may not cause harmful interference, and
- 2) This device must accept any interference received, including interference that may cause undesired operation.

MODIFICATION: Any changes or modifications not expressly approved by the grantee of this device could void the user's authority to operate the device.

CE

(1) The mains plug is used as disconnect device, the disconnect device shall remain readily operable.



(2)  Correct Disposal of this product. This marking indicates that this product should not be disposed with other household wastes throughout the EU. To prevent possible harm to the environment or human health from uncontrolled waste disposal, recycle it responsibly to promote the sustainable reuse of material resources. To return your used device, please use the return and collection systems or contact the retailer where the product was purchased. They can take this product for environmental safe recycling.



(3) The connections for the protective conductors shall be reliable.

(4) The connections for the protective conductors shall make earlier and shall break later than the supply connections.

INSTALLATION AND OPERATION WARNINGS

Please follow the provided installation and operation instructions to prevent any risk of injury or property damage.

- Do not install indoor products in a place with direct sunlight, moisture, rain or dust.
- Do not install the product in a place with heat from an electric source
- The user should not install or repair the product independently
- Do not allow liquids or chemicals get into the product
- Do not use cables other than the provided ones.
- Disconnect AC power supply before battery installation
- Follow batteries disconnection procedure and do not remove batteries without system acknowledgement.

REGULATIONS		
CE Marked		
EN 62368-1:2014+A1:2017 EN 55032:2015 EN 55035:2017 EN 61000-3-2:2019/-3:2013 EN 301 489-1/-3/-17 EN 300 328 EN 300 330	EN 62479:2010 EN 50663:2017 EN 50664:2017 EN 50665:2017 EN 62311:2008 EN 302 208	
BY TECHDESIGN, S.L. declares that the radio equipments in this system (operating in the 2,4 GHz and in 13,56 MHz ISM band) are in compliance with Directive 2014/53/EU and relating to electromagnetic compatibility the equipments are in compliance with Directive 2014/35/EU and Directive 2014/30/EU		
FCC Marked		
47 CFR part 15 sub-part B and C		
This system complies with part 15 of the FCC Rules. Operation is subject to the following two conditions: (1) This system may not cause harmful interference, and (2) this system must accept any interference received, including interference that may cause undesired operation.		

EU Declaration of Conformity (CE)

This manual covers the following products:

- NÜO DC GO!8, NÜO SDU and NÜO SDU+, from now on referred to as GROUP 1
- NÜO POLO, NÜO GOLF, NÜO AIR and NÜO RUN, from now on referred to as GROUP 2

All these products are CE marked according to the provisions of:

- Group 1: EMC Directive (2014/30/UE) and Low Voltage Directive (2014/35/UE)
- Group 2: Radio Equipment Directive (2014/53/UE)

Hereby, BY TECHDESIGN S.L. declares that each product is in compliance with the essential requirements and other relevant provisions of such directives.

Please visit our website www.nuoplanet.com for further information and contact details.