

Remote Control Boat

AGE 14+

Beginner's Guide

- After connect the battery socket, the boat will automatically power on when it touches the water, and it can be directly connected to the remote controller. When the connection is successful, the boat's light and the remote control's lights will be always on.
- The control distance of the boat should not exceed 50 meters, otherwise it may get out of control and lose contact.
- When the battery is fully charged, the total battery life of the boat is about 20 minutes. When the voltage is low, the boat's light will change from steady to fast flashing, and it will automatically switch to the low speed gear. Please be sure to return to the controllable range 5 minutes in advance, otherwise it will lead to failure to return the boat.
- When sailing, avoid debris such as aquatic, and avoid anything getting caught in the propeller.
- The navigation rudder needs to be manually adjusted.
- The boat is in the low speed gear by default when starting, and the high and low speeds mode can be switched by the speed button.
- If the remote control fails to connect to the boat within 2 minutes of being turned on, the remote control will automatically enter sleep mode, the indicator light will change from slow flashing to off, and can be restarted by any key.
- If it leaves the water surface when the humidity of the bottom of the boat is high, there is still a risk of conduction. Please keep the bottom of the boat dry.

1

Accessories table

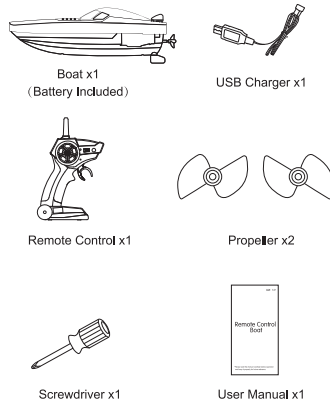

Note:

Please carefully count the parts and quantity. If you find that the parts are not complete, please provide proof of purchase and contact the sales merchant for replacement in time.

2

Meet your remote control boat

The remote control boat uses 2.4GHZ high-frequency remote control system, which is suitable for multi-player competition. Players can control the boat to run in the water, realize forward, backward, turn left and turn right.

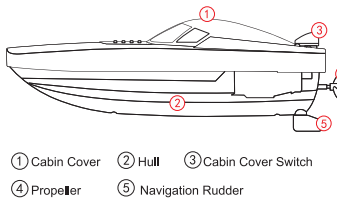

Meet your remote control

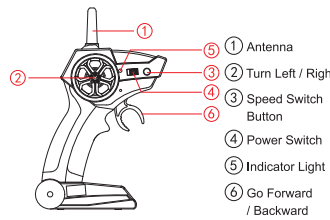

3

Boat battery installation

- Unscrew the cabin cover switch counterclockwise.
- Lift the tail of the cabin to 45 degrees and pull it out firmly.
- Connect the battery socket and install the battery into the battery holder, taking care not to reverse the plug.
- Insert the cabin at a 45-degree angle into the hull and push it forward.
- Close on the cabin and lock the hatch switch clockwise.

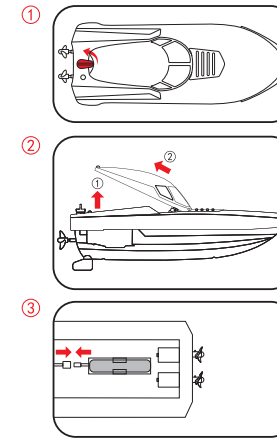

4

Remote control battery installation

Open the battery cover, and correctly insert two AA batteries according to the electrode instructions, (batteries need to be purchased separately)

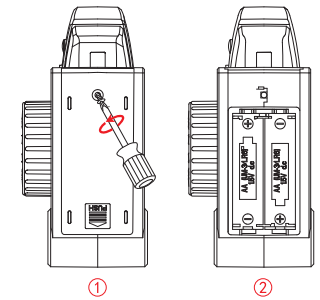

Note:

- When inserting the battery, the positive and negative poles of the battery must be identified, and they cannot be reversed.
- Do not mix old and new batteries. Do not mix different types of batteries.

5

*Please read this manual carefully before operation and keep it properly for future reference.

Operation with remote control

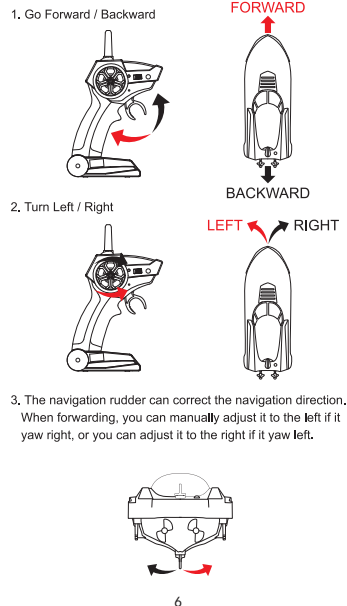

6

Boat battery charging

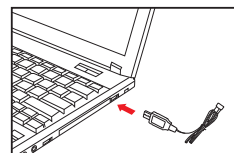

1 Insert the USB to the computer or the charging base of mobile phone.

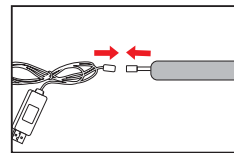

2 Connect the battery plug to the USB charger.

Note:

The charging time is about 120 minutes and the total use time is about 20 minutes. The red-light flashes when battery is charging, and turns off when full.

7

Attention to battery use!

- The use of battery has certain risks and may cause significant losses to people and property. Please use them with caution and bear all related responsibilities.
- If the battery leaks, avoid liquid contact with skin and eyes. In case of skin contact, wash immediately with soap and water. In case of contact with eyes, rinse immediately with plenty of cold water and seek medical advice immediately.
- If the charger emits suspicious odor, noise, or smoke, unplug it immediately.

Charge

- Please use the special charger delivered by the original factory for charging. It is strictly forbidden to use damaged or other brand chargers.
- Do not charge swollen, leaked or damaged batteries.
- Do not overcharge the battery. When the battery is fully charged, unplug the charger.
- Do not charge close to flammable objects (carpets, wooden floors, solid wood furniture, etc.) or conductive objects. Keep the battery in sight when charging.
- Never charge the battery immediately after using the product when the battery is still hot.
- The battery charging temperature should be between 0 ° C and 40 ° C.

Recycle

- This device consists of electronic components and battery. For electronic and electrical waste, please follow the local waste disposal requirements for special treatment.

8

Safety warning

- This product must be used under adult supervision. This remote boat is not a toy, only for children over 14 years old.
- After use, wait for the battery to cool down before recharging.
- When sailing, you must first ensure that there are no people in the sailing water area to avoid injury. There should be no aquatic or debris on the water surface to prevent the propeller from getting entangled in the water or damage to the remote boat.
- The effective remote distance is about 50 meters. Please do not exceed the effective control distance to avoid loss of control.
- This product contains small parts. Do not swallow it to avoid suffocation.
- Keep a safe distance from the propeller rotating at high speed to avoid the risk of angulation.
- The motor is a hot part, please do not touch it to avoid the risk of burns.
- In order to ensure the requirements of the electromagnetic environment of aeronautical radio stations (stations), it is prohibited to use various model remote controls in the area centered on the runway of the airport and with a radius of 5000 meters.
- During the period and area where the relevant national authority issues radio control orders, the model remote control should be stopped as required.
- Regularly check the USB cable and other components. If they are damaged, stop using them until the repair is complete.

9

Maintenance and repair

- When the remote boat stops working, the battery must be removed.
- The surface of the remote boat should avoid prolonged exposure to the sun and prevent paint stripping. After each use, the surface of the remote boat should be cleaned with dry soft cloth.
- When the remote boat is not used for a long time, the remote control battery must be taken out to prevent the battery leakage from damaging the remote control.

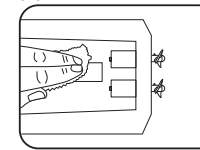

2

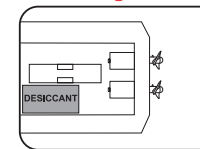

3

Note:

After each use of the remote boat, a dry soft cloth should be used to absorb the water in the cabin and put a desiccant to ensure that the hull is dry and clean.

10

NOTE: This equipment has been tested and found to comply with the limits for a Class B digital device, pursuant to part 15 of the FCC Rules. These limits are designed to provide reasonable protection against harmful interference in a residential installation. This equipment generates uses and can radiate radio frequency energy and, if not installed and used in accordance with the instructions, may cause harmful interference to radio communications. However, there is no guarantee that interference will not occur in a particular installation. If this equipment does cause harmful interference to radio or television reception, which can be determined by turning the equipment off and on, the user is encouraged to try to correct the interference by one or more of the following measures:

- Reorient or relocate the receiving antenna.
- Increase the separation between the equipment and receiver.
- Connect the equipment into an outlet on a circuit different from that to which the receiver is connected.
- Consult the dealer or an experienced radio/TV technician for help.

Changes or modifications not expressly approved by the party responsible for compliance could void the user's authority to operate the equipment.

This device complies with Part 15 of the FCC Rules. Operation is subject to the following two conditions:

- this device may not cause harmful interference, and
- this device must accept any interference received, including interference that may cause undesired operation.