

# FCC RADIO TEST REPORT

**FCC ID: 2ARNF-M07326**

**Product:** Wireless Bluetooth Controller for SNES/ PC/ Mac

**Trade Name:** Hyperkin

**Model Name:** M07326

**Serial Model:** N/A

**Report No.:** UNIA2018101130FR-01

## Prepared for

Hyperkin,inc

1939 W. Mission Blvd., Pomona, CA 91766

## Prepared by

Shenzhen United Testing Technology Co., Ltd.

2F, Annex Bldg, Jiahuangyuan Tech Park, #365 Baotian 1 Rd, Tiegang  
Community, Xixiang Str, Bao'an District, Shenzhen, China

### TEST RESULT CERTIFICATION

**Applicant's name** .....: Hyperkin,inc

Address.....: 1939 W. Mission Blvd., Pomona, CA 91766

**Manufacture's Name**.....: QS POWER TECHNOLOGY CO., LTD

Address.....: 2F No.101, Xiangyuandong Road, Shangtun Village, LiaoBu Town, Dongguan City, Guang Dong, China

**Product description**

Product name .....: Wireless Bluetooth Controller for SNES/ PC/ Mac

Trade Mark.....: Hyperkin

Model and/or type reference : M07326

**Standards** .....: FCC Rules and Regulations Part 15 Subpart C Section 15.247  
ANSI C63.10: 2013

This device described above has been tested by Shenzhen United Testing Technology Co., Ltd., and the test results show that the equipment under test (EUT) is in compliance with the FCC requirements. And it is applicable only to the tested sample identified in the report.

This report shall not be reproduced except in full, without the written approval of UNI, this document may be altered or revised by Shenzhen United Testing Technology Co., Ltd., personnel only, and shall be noted in the revision of the document.

**Date of Test**.....: Oct. 18, 2018

Date (s) of performance of tests.....: Oct. 18, 2018 -- Nov. 05, 2018

Date of Issue.....: Nov. 05, 2018

Test Result.....: Pass

Prepared by:

Kahn yang/Editor

Reviewer:

Sherman Qian/Supervisor

Approved & Authorized Signer:

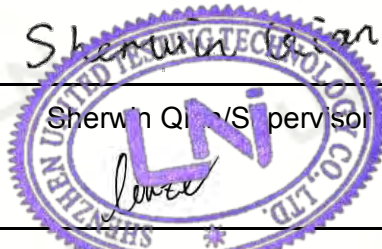

Liuze/Manager

# Table of Contents

<b>1</b>	<b>TEST SUMMARY .....</b>	<b>4</b>
<b>2</b>	<b>GENERAL INFORMATION .....</b>	<b>5</b>
2.1	ENVIRONMENTAL CONDITIONS .....	5
2.2	GENERAL DESCRIPTION OF EUT.....	5
2.3	CARRIER FREQUENCY OF CHANNELS .....	6
2.4	OPARATION OF EUT DURING TESTING .....	6
2.5	DESCRIPTION OF TEST SETUP .....	6
2.6	MEASUREMENT INSTRUMENTS LIST .....	7
<b>3</b>	<b>TEST CONDITIONS AND RESULTS .....</b>	<b>8</b>
3.1	CONDUCTED EMISSIONS TEST.....	8
3.2	RADIATED EMISSION TEST.....	11
3.3	BAND EDGE .....	18
3.4	CONDUCTED OUTPUT POWER .....	20
3.5	OCCUPIED BANDWIDTH MEASUREMENT.....	26
3.6	Frequency Separation.....	32
3.7	Number of hopping frequency .....	35
3.8	Time of Occupancy (Dwell Time).....	37
3.9	OUT-OF BAND EMISSIONS.....	43
3.10	Pseudorandom Frequency Hopping Sequence.....	51
3.11	ANTENNA REQUIREMENT .....	53
<b>4</b>	<b>PHOTOGRAPH OF TEST .....</b>	<b>54</b>
<b>5</b>	<b>PHOTOGRAPH OF EUT .....</b>	<b>55</b>

# 1 TEST SUMMARY

## 1 TEST PROCEDURES AND RESULTS

FCC PART 15.247		
FCC Part 15.207	AC Power Conducted Emission	PASS
FCC Part 15.247(a)(1)(i)	20dB Bandwidth	PASS
FCC Part 15.247(d)	Spurious RF Conducted Emission	PASS
FCC Part 15.247(b)	Maximum Peak Output Power	PASS
FCC Part 15.247(b)	Pseudorandom Frequency Hopping Sequence	PASS
FCC Part 15.247(a)(1)(iii)	Number of hopping frequency& Time of Occupancy	PASS
FCC Part 15.247(a)(1)	Frequency Separation	PASS
FCC Part 15.205/15.209	Radiated Emissions	PASS
FCC Part 15.247(d)	Band Edge Compliance of RF Emission	PASS
FCC Part 15.247(g)(h)	Pseudorandom Frequency Hopping Sequence	PASS
FCC Part 15.203/15.247 (b)	Antenna Requirement	PASS

## 2 TEST FACILITY

Test Firm : Shenzhen United Testing Technology Co., Ltd.

Address : 2F, Annex Bldg, Jiahuangyuan Tech Park, #365 Baotian 1 Rd, Tiegang Community, Xixiang Str, Bao'an District, Shenzhen, China

The testing quality ability of our laboratory meet with "Quality Law of People's Republic of China" Clause 19. The testing quality system of our laboratory meets with ISO/IEC-17025 requirements, which is approved by CNAS. This approval result is accepted by MRA of APLAC.

Our test facility is recognized, certified, or accredited by the following organizations:

CNAS-LAB Code: L6494

The EMC Laboratory has been assessed and in compliance with CNAS-CL01 accreditation criteria for testing Laboratories (identical to ISO/IEC 17025:2017 General Requirements) for the Competence of testing Laboratories.

Designation Number: CN1227

Test Firm Registration Number: 674885

The EMC Laboratory has been registered and fully described in a report filed with the (FCC) Federal Communications commission. The acceptance letter from the FCC is maintained in our files.

## 3 MEASUREMENT UNCERTAINTY

### Measurement Uncertainty

Conducted Emission Expanded Uncertainty	=	2.23dB, k=2
Radiated emission expanded uncertainty(9kHz-30MHz)	=	3.08dB, k=2
Radiated emission expanded uncertainty(30MHz-1000MHz)	=	4.42dB, k=2
Radiated emission expanded uncertainty(Above 1GHz)	=	4.06dB, k=2

## 2 GENERAL INFORMATION

### 2.1 ENVIRONMENTAL CONDITIONS

During the measurement the environmental conditions were within the listed ranges:

Temperature	Normal Temperature:	25°C
Voltage	Normal Voltage	DC 3.7V
Other	Relative Humidity	55 %
	Air Pressure	101 kPa

### 2.2 GENERAL DESCRIPTION OF EUT

Equipment	Wireless Bluetooth Controller for SNES/ PC/ Mac
Trade Mark	Hyperkin
Model Name	M07326
Serial No.	N/A
Model Difference	All models have the same functionality, software and electronics, only the color, front frame shape and model names may differ. Test sample model: M07326
FCC ID	2ARNF-M07326
Antenna Type	PCB Antenna
Antenna Gain	0.0 dbi
Frequency Range	2402MHz - 2480MHz
Number of Channels	79
Modulation Type	GFSK, $\pi$ /4DQPSK, 8DPSK
Battery	3.7V / 500mah 1.85Wh
Power Source	3.7V from battery
Adapter Model	N/A

### 2.3 CARRIER FREQUENCY OF CHANNELS

Channel	Frequency (MHz)
00	2402
01	2403
⋮	⋮
⋮	⋮
77	2479
78	2480

### 2.4 OPERATION OF EUT DURING TESTING

Operating Mode

The mode is used: Transmitting mode

Low Channel	2402MHz
Middle Channel	2441MHz
High Channel	2480MHz

### 2.5 DESCRIPTION OF TEST SETUP

Operation of EUT during Conducted testing:

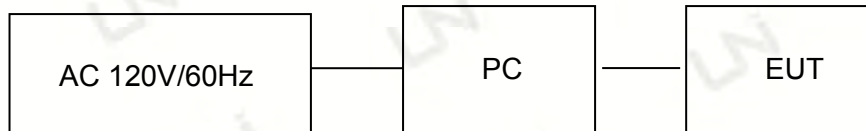

Operation of EUT during Radiation and Above1GHz Radiation testing:



2.6 MEASUREMENT INSTRUMENTS LIST

Item	Equipment	Manufacturer	Model No.	Serial No.	Calibrated until
<b>CONDUCTED EMISSIONS TEST</b>					
1	AMN	Schwarzbeck	NNLK8121	8121370	2019.09.09
2	AMN	ETS	3810/2	00020199	2019.09.09
3	EMI TEST RECEIVER	Rohde&Schwarz	ESCI	101210	2019.09.09
4	AAN	TESEQ	T8-Cat6	38888	2019.09.09
<b>RADIATED EMISSION TEST</b>					
1	Horn Antenna	Sunol	DRH-118	A101415	2019.09.29
2	BicoNLog Antenna	Sunol	JB1 Antenna	A090215	2019.09.29
3	PREAMP	HP	8449B	3008A00160	2019.09.09
4	PREAMP	HP	8447D	2944A07999	2019.09.09
5	EMI TEST RECEIVER	Rohde&Schwarz	ESR3	101891	2019.09.09
6	VECTOR Signal Generator	Rohde&Schwarz	SMU200A	101521	2019.09.28
7	Signal Generator	Agilent	E4421B	MY4335105	2019.09.28
8	MXA Signal Analyzer	Agilent	N9020A	MY50510140	2019.9.28
9	MXA Signal Analyzer	Agilent	N9020A	MY51110104	2019.09.09
10	ANT Tower&Turn table Controller	Champro	EM 1000	60764	2019.09.28
11	Anechoic Chamber	Taihe Maorui	9m*6m*6m	966A0001	2019.09.09
12	Shielding Room	Taihe Maorui	6.4m*4m*3m	643A0001	2019.09.09
13	RF Power sensor	DARE	RPR3006W	15I00041SNO88	2019.03.14
14	RF Power sensor	DARE	RPR3006W	15I00041SNO89	2019.03.14
15	RF power divider	Anritsu	K241B	992289	2019.09.28
16	Wideband radio communication tester	Rohde&Schwarz	CMW500	154987	2019.09.28
17	Biconical antenna	Schwarzbeck	VHA 9103	91032360	2019.09.08
18	Biconical antenna	Schwarzbeck	VHA 9103	91032361	2019.09.08
19	Broadband Hybrid Antennas	Schwarzbeck	VULB9163	VULB9163#958	2019.09.08
20	Horn Antenna	Schwarzbeck	BBHA9120D	9120D-1680	2019.01.12
21	Active Receive Loop Antenna	Schwarzbeck	FMZB 1919B	00023	2019.11.02
22	Horn Antenna	Schwarzbeck	BBHA 9170	BBHA9170651	2019.03.14
23	Microwave Broadband Pre-amplifier	Schwarzbeck	BBV 9721	100472	2019.10.24
24	Active Loop Antenna	Com-Power	AL-130R	10160009	2019.05.10
25	Power Meter	KEYSIGHT	N1911A	MY50520168	2019.05.10

### 3 TEST CONDITIONS AND RESULTS

#### 3.1 CONDUCTED EMISSIONS TEST

##### Limit

For unintentional device, according to § 15.107(a) Line Conducted Emission Limits is as following

Frequency range (MHz)	Limit (dBuV)	
	Quasi-peak	Average
0.15-0.5	66 to 56*	56 to 46*
0.5-5	56	46
5-30	60	50

\* Decreasing linearly with the logarithm of the frequency

For intentional device, according to §15.207(a) Line Conducted Emission Limit is same as above table.

##### Test Setup

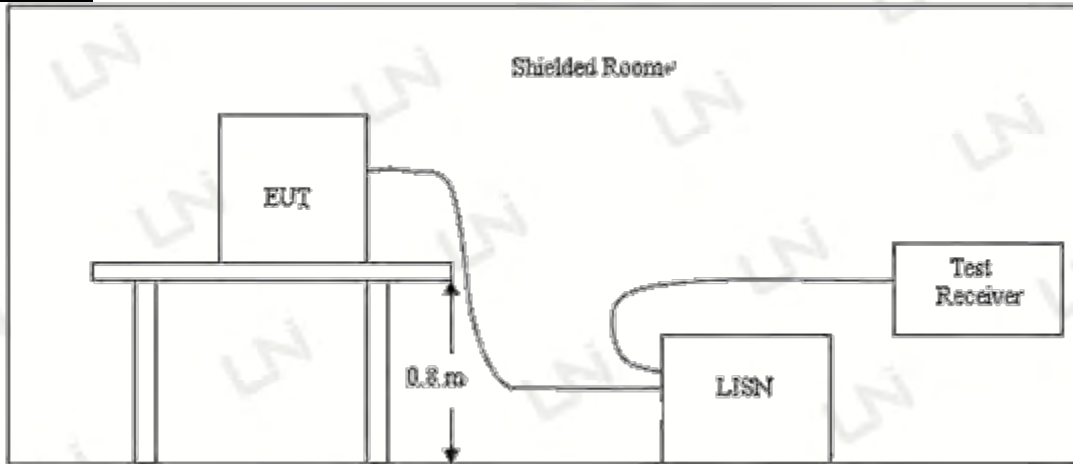

##### Test Procedure

- 1, The equipment was set up as per the test configuration to simulate typical actual usage per the user's manual. A wooden table with a height of 0.8 meters is used and is placed on the ground plane as per ANSI C63.10.
- 2, Support equipment, if needed, was placed as per ANSI C63.10.
- 3, All I/O cables were positioned to simulate typical actual usage as per ANSI C63.10.
- 4, If a EUT received DC power from the USB Port of Notebook PC, the PC's adapter received AC120V/60Hz power through a Line Impedance Stabilization Network (LISN) which supplied power source and was grounded to the ground plane.
- 5, All support equipments received AC power from a second LISN, if any.
- 6, The EUT test program was started. Emissions were measured on each current carrying line of the EUT using a spectrum Analyzer / Receiver connected to the LISN powering the EUT. The LISN has two monitoring points: Line 1 (Hot Side) and Line 2 (Neutral Side). Two scans were taken: one with Line 1 connected to Analyzer / Receiver and Line 2 connected to a 50 ohm load; the second scan had Line 1 connected to a 50 ohm load and Line 2 connected to the Analyzer / Receiver.
- 7, Analyzer / Receiver scanned from 150 KHz to 30MHz for emissions in each of the test modes.

##### Test Result

---PASS---



Please refer to test data as follows:

Temperature:	25°C	Relative Humidity:	48%
Test Date:	Oct. 27, 2018	Pressure:	1030hPa
Test Voltage:	AC 120V 60Hz	Polarization:	

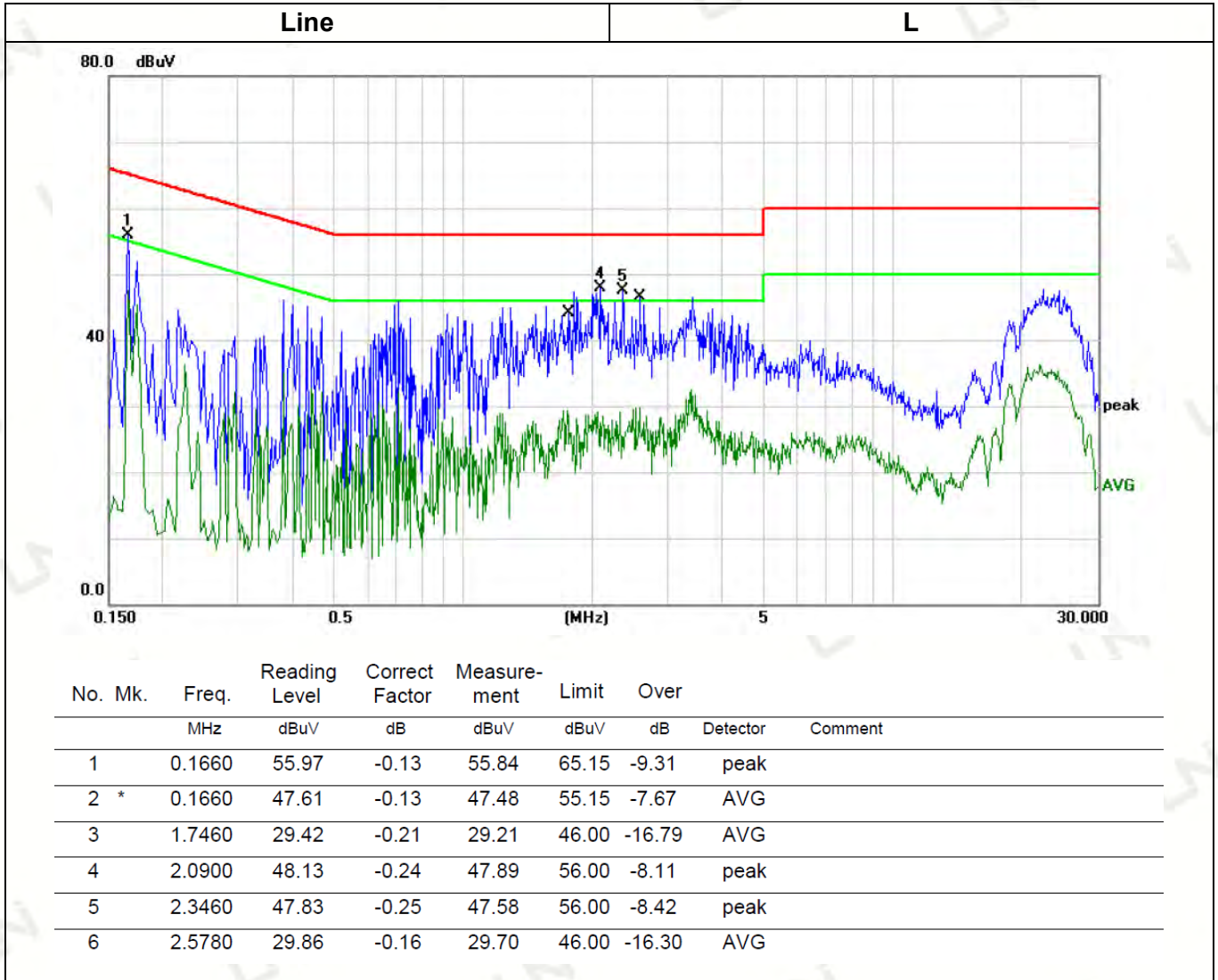

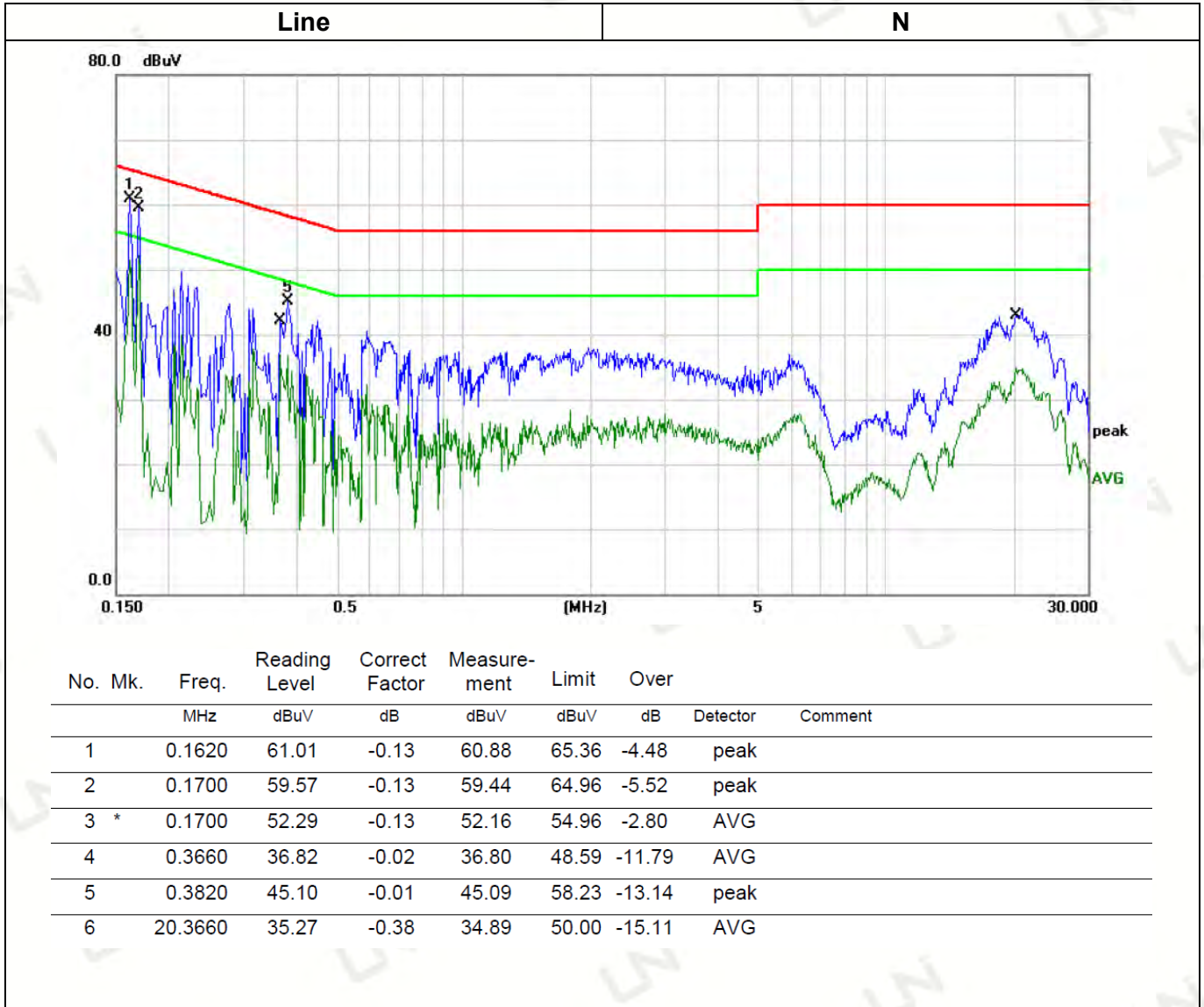

### 3.2 RADIATED EMISSION TEST

#### Radiation Limit

For unintentional device, according to § 15.109(a), except for Class A digital devices, the field strength of radiated emissions from unintentional radiators at a distance of 3 meters shall not exceed the following values:

Frequency (MHz)	Distance (Meters)	Radiated (dB $\mu$ V/m)	Radiated ( $\mu$ V/m)
30-88	3	40	100
88-216	3	43.5	150
216-960	3	46	200
Above 960	3	54	500

For intentional device, according to § 15.209(a), the general requirement of field strength of radiated emissions from intentional radiators at a distance of 3 meters shall not exceed the above table.

#### Test Setup

##### 1. Radiated Emission Test-Up Frequency Below 30MHz

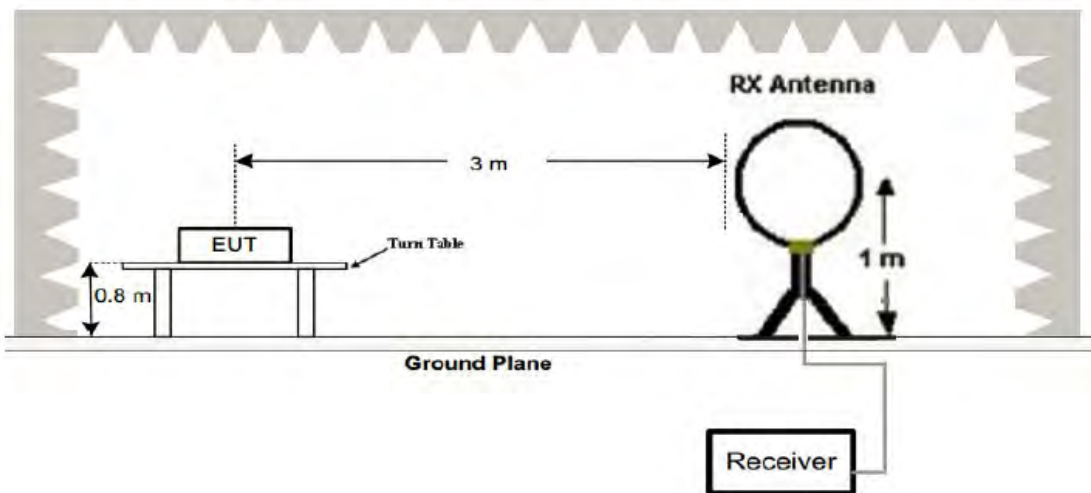

##### 2. Radiated Emission Test-Up Frequency 30MHz~1GHz

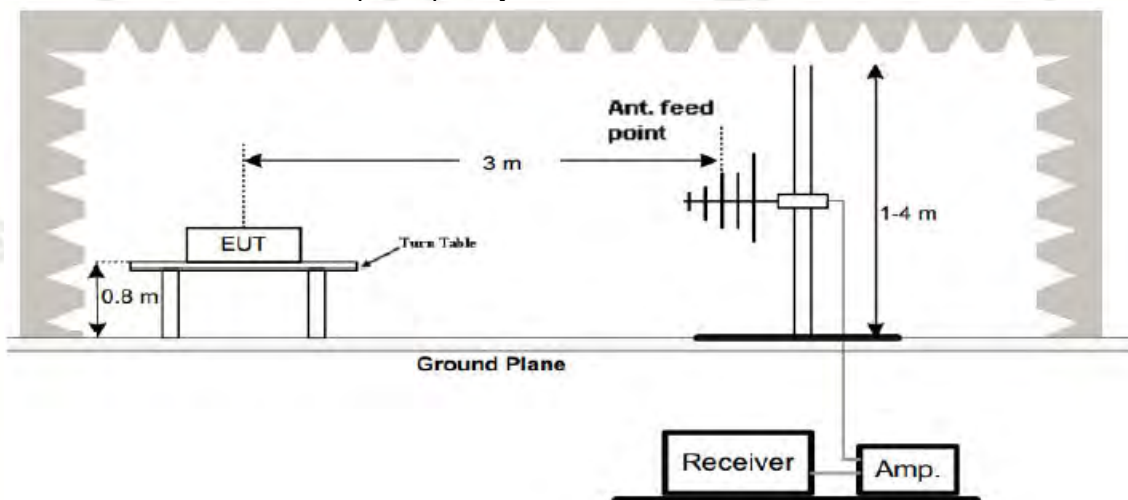

### 3. Radiated Emission Test-Up Frequency Above 1GHz

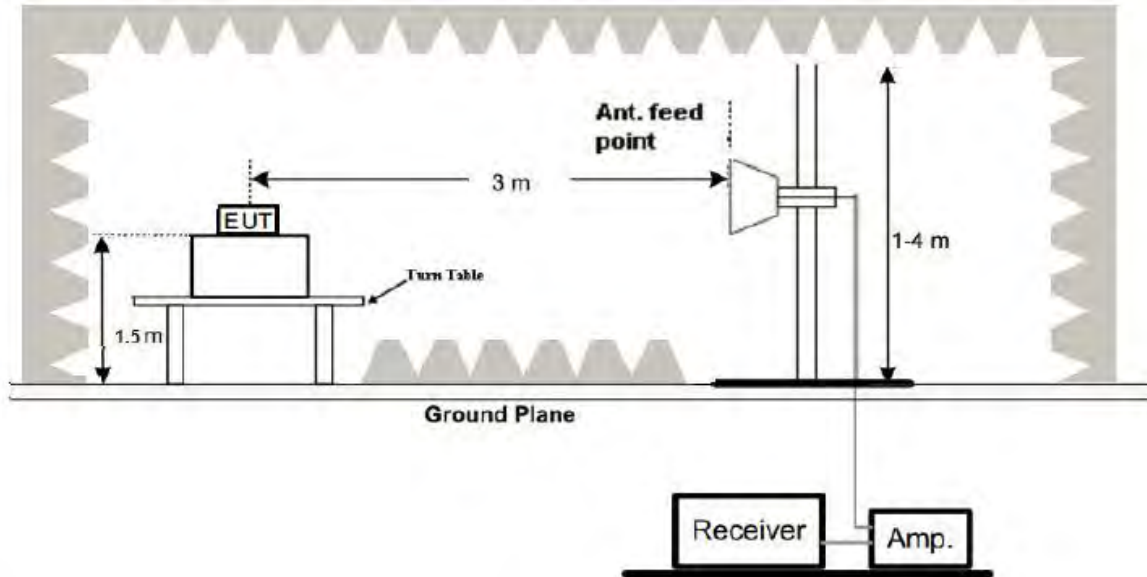

#### Test Procedure

1. Below 1GHz measurement the EUT is placed on turntable which is 0.8m above ground plane. And above 1GHz measurement EUT was placed on low permittivity and low tangent turn table which is 1.5m above ground plane.
2. The turntable shall be rotated for 360 degrees to determine the position of maximum emission level.
3. EUT is set 3m away from the receiving antenna, which is varied from 1m to 4m to find out the highest emissions.
4. Maximum procedure was performed on the six highest emissions to ensure EUT compliance.
5. And also, each emission was to be maximized by changing the polarization of receiving antenna both horizontal and vertical.
6. Repeat above procedures until the measurements for all frequencies are complete.
7. The test frequency range from 9kHz to 25GHz per FCC PART 15.33(a).

**Note:**

For battery operated equipment, the equipment tests shall be performed using a new battery.

#### Test Result

**---PASS---**

**Remark:**

1. All the test modes completed for test. The worst case of Radiated Emission is Middle channel, the test data of this mode was reported.
2. By preliminary testing and verifying three axis (X, Y and Z) position of EUT transmitted status, it was found that "Z axis" position was the worst, and test data recorded in this report.
3. Radiated emission test from 9KHz to 10th harmonic of fundamental was verified, and no emission found except system noise floor in 9KHz to 30MHz and not recorded in this report.

Below 1GHz Test Results:

Temperature:	25°C	Relative Humidity:	48%
Test Date:	Oct.27, 2018	Pressure:	1030hPa
Test Voltage:	DC 3.7V from battery	Polarization:	Horizontal/ Vertical

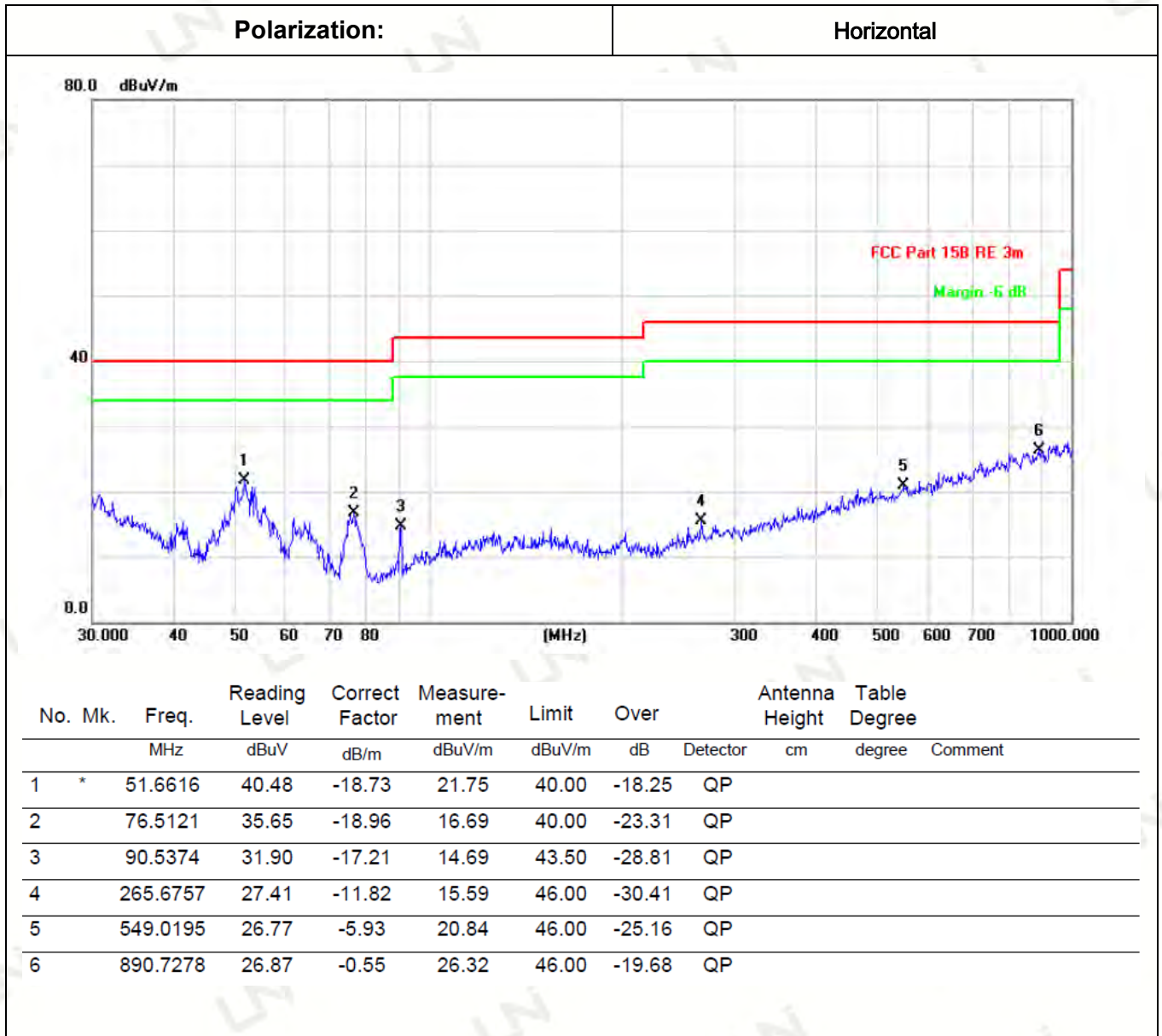

Remark: Absolute Level= Reading Level+ Factor, Margin= Absolute Level – Limit  
 Factor=Ant. Factor + Cable Loss – Pre-amplifier

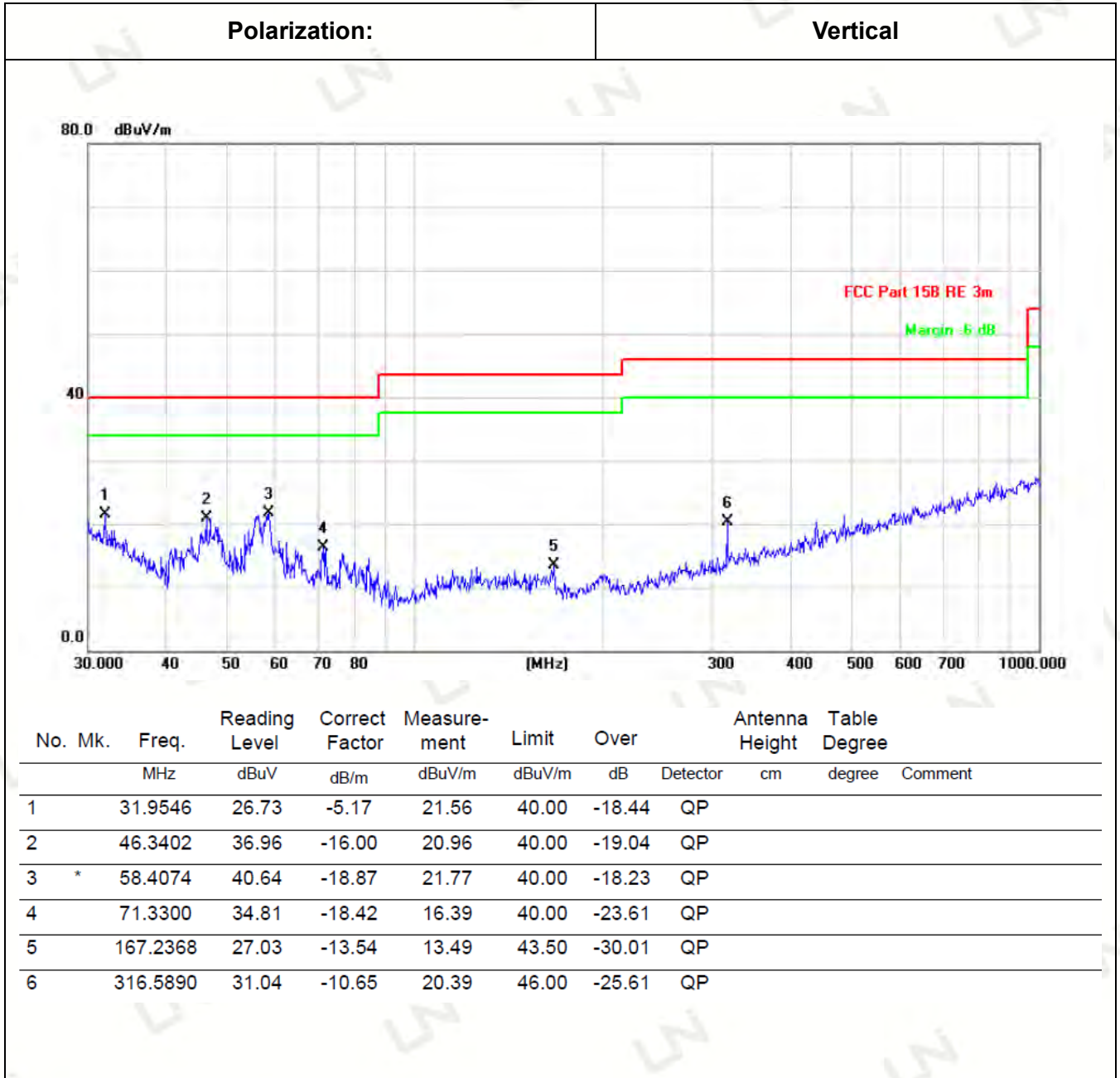

Remark: Absolute Level= Reading Level+ Factor, Margin= Absolute Level – Limit  
 Factor=Ant. Factor + Cable Loss – Pre-amplifier

Remark:

- (1) Measuring frequencies from 9 kHz to the 1 GHz, Radiated emission test from 9kHz to 30MHz was verified, and no any emission was found except system noise floor.
- (2) \* denotes emission frequency which appearing within the Restricted Bands specified in provision of 15.205, then the general radiated emission limits in 15.209 apply.
- (3) The IF bandwidth of EMI Test Receiver between 30MHz to 1GHz was 120KHz, 1 MHz for measuring above 1 GHz, below 30MHz was 10KHz.

**Above 1 GHz Test Results:**

Note: GFSK, Pi/4 DQPSK, 8DPSK all have been tested, only worse case GFSK is reported.

**GFSK: CH Low (2402MHz)**

**Horizontal:**

Frequency (MHz)	Reading Result (dB $\mu$ V)	Factor (dB)	Emission Level (dB $\mu$ V/m)	Limits (dB $\mu$ V/m)	Margin (dB)	Detector Type
4804.00	56.93	-3.64	53.29	74	20.71	PK
4804.00	44.44	-3.64	40.80	54	13.20	AV
5745.50	55.70	-2.34	53.36	74	20.64	PK
5745.50	45.62	-2.34	43.28	54	10.72	AV
7206.00	55.12	-0.95	54.17	74	19.83	PK
7206.00	40.47	-0.95	39.52	54	14.48	AV

Remark: Factor = Antenna Factor + Cable Loss – Pre-amplifier. Margin= Absolute Level – Limit

**Vertical:**

Frequency (MHz)	Reading Result (dB $\mu$ V)	Factor (dB)	Emission Level (dB $\mu$ V/m)	Limits (dB $\mu$ V/m)	Margin (dB)	Detector Type
4804.00	57.47	-3.64	53.83	74	20.17	PK
4804.00	44.34	-3.64	40.70	54	13.30	AV
5745.50	57.02	-2.34	54.68	74	19.32	PK
5745.50	44.80	-2.34	42.46	54	11.54	AV
7206.00	54.87	-0.95	53.92	74	20.08	PK
7206.00	43.92	-0.95	42.97	54	11.03	AV

Remark: Factor = Antenna Factor + Cable Loss – Pre-amplifier. Margin= Absolute Level – Limit

GFSK: CH Middle (2441MHz)

**Horizontal:**

Frequency (MHz)	Reading Result (dBμV)	Factor (dB)	Emission Level (dBμV/m)	Limits (dBμV/m)	Margin (dB)	Detector Type
4882.00	58.53	-3.51	55.02	74	18.98	PK
4882.00	43.79	-3.51	40.28	54	13.72	AV
5366.50	57.09	-2.41	54.68	74	19.32	PK
5366.50	45.46	-2.41	43.05	54	10.95	AV
7323.00	54.74	-0.82	53.92	74	20.08	PK
7323.00	40.38	-0.82	39.56	54	14.44	AV

Remark: Factor = Antenna Factor + Cable Loss – Pre-amplifier. Margin= Absolute Level – Limit

**Vertical:**

Frequency (MHz)	Reading Result (dBμV)	Factor (dB)	Emission Level (dBμV/m)	Limits (dBμV/m)	Margin (dB)	Detector Type
4882.00	56.68	-3.51	53.17	74	20.83	PK
4882.00	44.55	-3.51	41.04	54	12.96	AV
5366.50	57.38	-2.41	54.97	74	19.03	PK
5366.50	45.52	-2.41	43.11	54	10.89	AV
7323.00	54.39	-0.82	53.57	74	20.43	PK
7323.00	43.85	-0.82	43.03	54	10.97	AV

Remark: Factor = Antenna Factor + Cable Loss – Pre-amplifier. Margin= Absolute Level – Limit



GFSK: CH High (2480MHz)

**Horizontal:**

Frequency (MHz)	Reading Result (dBµV)	Factor (dB)	Emission Level (dBµV/m)	Limits (dBµV/m)	Margin (dB)	Detector Type
4960.00	57.25	-3.43	53.82	74	20.18	PK
4960.00	45.77	-3.43	42.34	54	11.66	AV
5750.60	55.79	-2.33	53.46	74	20.54	PK
5750.60	44.04	-2.33	41.71	54	12.29	AV
7440.00	55.15	-0.75	54.40	74	19.60	PK
7440.00	41.63	-0.75	40.88	54	13.12	AV

Remark: Factor = Antenna Factor + Cable Loss – Pre-amplifier. Margin= Absolute Level – Limit

**Vertical:**

Frequency (MHz)	Reading Result (dBµV)	Factor (dB)	Emission Level (dBµV/m)	Limits (dBµV/m)	Margin (dB)	Detector Type
4960.00	58.14	-3.43	54.71	74	19.29	PK
4960.00	43.23	-3.43	39.80	54	14.20	AV
5750.60	56.03	-2.33	53.70	74	20.30	PK
5750.60	45.06	-2.33	42.73	54	11.27	AV
7440.00	54.69	-0.75	53.94	74	20.06	PK
7440.00	42.46	-0.75	41.71	54	12.29	AV

Remark: Factor = Antenna Factor + Cable Loss – Pre-amplifier. Margin= Absolute Level – Limit

Remark:

- (1) Measuring frequencies from 1 GHz to the 25 GHz.
- (2) "F" denotes fundamental frequency; "H" denotes spurious frequency. "E" denotes band edge frequency.
- (3) \* denotes emission frequency which appearing within the Restricted Bands specified in provision of 15.205, then the general radiated emission limits in 15.209 apply.
- (4) Data of measurement within this frequency range shown "---" in the table above means the reading of emissions are attenuated more than 20dB below the permissible limits or the field strength is too small to be measured.
- (5) The IF bandwidth of EMI Test Receiver between 30MHz to 1GHz was 120KHz, 1 MHz for measuring above 1 GHz, below 30MHz was 10KHz. The resolution bandwidth of test receiver/spectrum analyzer is 1MHz and video bandwidth is 3MHz for peak measurement with peak detector at frequency above 1GHz. The resolution bandwidth of test receiver/spectrum analyzer is 1MHz and video bandwidth is 10Hz for Average measurement with peak detection at frequency above 1GHz.
- (6) When the test results of Peak Detected below the limits of Average Detected, the Average Detected is not need completed. For example: Top Channel at Fundamental 73.16dBuV/m(PK Value) <93.98(AV Limit), at harmonic 53.20 dBuV/m(PK Value) <54 dBuV/m(AV Limit), the Average Detected not need to completed.
- (7) All modes of operation were investigated and the worst-case emissions are reported.

### 3.3 BAND EDGE

#### Limits

In any 100 kHz bandwidth outside the frequency band in which the spread spectrum or digitally modulated intentional radiator is operating, the radio frequency power that is produced by the intentional radiator shall be at least 20 dB below that in the 100 kHz bandwidth within the band that contains the highest level of the desired power, based on either an RF conducted or a radiated measurement, provided the transmitter demonstrates compliance with the peak conducted power limits. If the transmitter complies with the conducted power limits based on the use of RMS averaging over a time interval, as permitted under paragraph (b)(3) of this section, the attenuation required under this paragraph shall be 30 dB instead of 20 dB. Attenuation below the general limits specified in §15.209(a) is not required. In addition, radiated emissions which fall in the restricted bands, as defined in §15.205(a), must also comply with the radiated emission limits specified in §15.209(a) (see §15.205(c)).

#### Test Procedure

The band edge compliance of RF radiated emission should be measured by following the guidance in ANSI C63.10 with respect to maximizing the emission by rotating the EUT, measuring the emission while the EUT is situated in three orthogonal planes (if appropriate), adjusting the measurement antenna height and polarization etc. Set RBW to 100KHz and VBM to 300KHz to measure the peak field strength and set RBW to 1MHz and VBW to 10Hz to measure the average radiated field strength. The conducted RF band edge was measured by using a spectrum analyzer. Set span wide enough to capture the highest in-band emission and the emission at the band edge. Set RBW to 100 kHz and VBW to 300 kHz, to measure the conducted peak band edge.

#### Test Result

---PASS---

Radiated Band Edge Test:

Operation Mode: TX CH Low (2402MHz)

Horizontal (Worst case):

Frequency (MHz)	Reading Result (dBµV)	Factor (dB)	Emission Level (dBµV/m)	Limits (dBµV/m)	Margin (dB)	Detector Type
2330.00	59.87	-5.78	54.09	74	19.91	PK
2330.00	37.07	-5.78	31.29	54	22.71	AV
2390.00	57.06	-5.84	51.22	74	22.78	PK
2390.00	39.44	-5.84	33.60	54	20.40	AV
2400.00	68.47	-5.84	62.63	74	11.37	PK
2400.00	44.22	-5.84	38.38	54	15.62	AV

Remark: Factor = Antenna Factor + Cable Loss – Pre-amplifier.

Vertical:

Frequency (MHz)	Reading Result (dBμV)	Factor (dB)	Emission Level (dBμV/m)	Limits (dBμV/m)	Margin (dB)	Detector Type
2330.00	58.53	-5.78	52.75	74	21.25	PK
2330.00	37.53	-5.78	31.75	54	22.25	AV
2390.00	57.50	-5.84	51.66	74	22.34	PK
2390.00	40.59	-5.84	34.75	54	19.25	AV
2400.00	67.74	-5.84	61.90	74	12.10	PK
2400.00	44.77	-5.84	38.93	54	15.07	AV

Remark: Factor = Antenna Factor + Cable Loss – Pre-amplifier.

Operation Mode: TX CH High (2480MHz)

Horizontal (Worst case):

Frequency (MHz)	Reading Result (dBμV)	Factor (dB)	Emission Level (dBμV/m)	Limits (dBμV/m)	Margin (dB)	Detector Type
2483.50	59.98	-5.65	54.33	74	19.67	PK
2483.50	37.65	-5.65	32.00	54	22.00	AV
2487.50	58.06	-5.65	52.41	74	21.59	PK
2487.50	41.43	-5.65	35.78	54	18.22	AV
2500.00	68.60	-5.72	62.88	74	11.12	PK
2500.00	45.08	-5.72	39.36	54	14.64	AV

Remark: Factor = Antenna Factor + Cable Loss – Pre-amplifier.

Vertical:

Frequency (MHz)	Reading Result (dBμV)	Factor (dB)	Emission Level (dBμV/m)	Limits (dBμV/m)	Margin (dB)	Detector Type
2483.50	59.59	-5.65	53.94	74	20.06	PK
2483.50	38.82	-5.65	33.17	54	20.83	AV
2487.50	57.05	-5.65	51.40	74	22.60	PK
2487.50	42.06	-5.65	36.41	54	17.59	AV
2500.00	66.08	-5.72	60.36	74	13.64	PK
2500.00	43.97	-5.72	38.25	54	15.75	AV

Remark: Factor = Antenna Factor + Cable Loss – Pre-amplifier.

### 3.4 CONDUCTED OUTPUT POWER

#### Limit

The Maximum Peak Output Power Measurement is 30dBm.

#### Test Procedure

Remove the antenna from the EUT and then connect a low loss RF cable from the antenna port to the power sensor.

#### Test Configuration

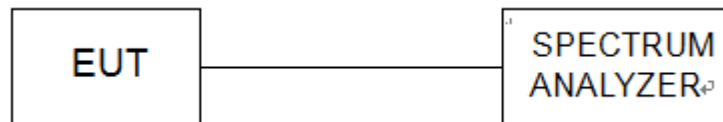

#### Test Result

Type	Channel	Output power (dBm)	Limit (dBm)	Result
GFSK	00	0.007	20.97	Pass
	39	0.734		
	78	0.955		
π/4DQPSK	00	-1.985	20.97	Pass
	39	-0.255		
	78	-0.092		
8DPSK	00	-1.699	20.97	Pass
	39	-0.113		
	78	0.072		

Note: 1.The test results including the cable lose.

### GFSK Modulation

#### CH00

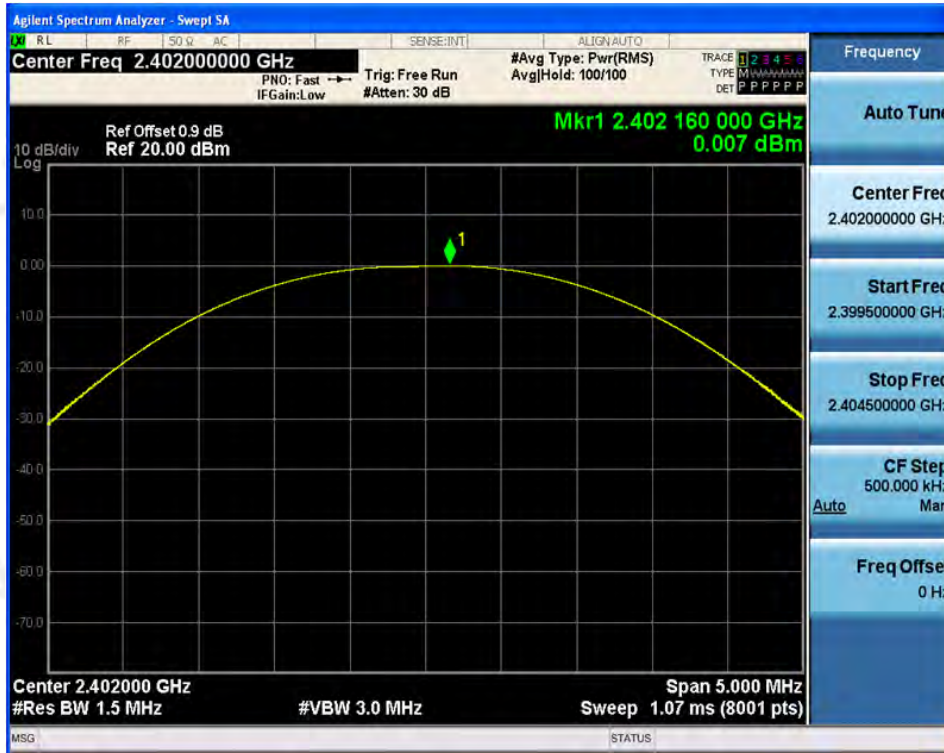

#### CH39

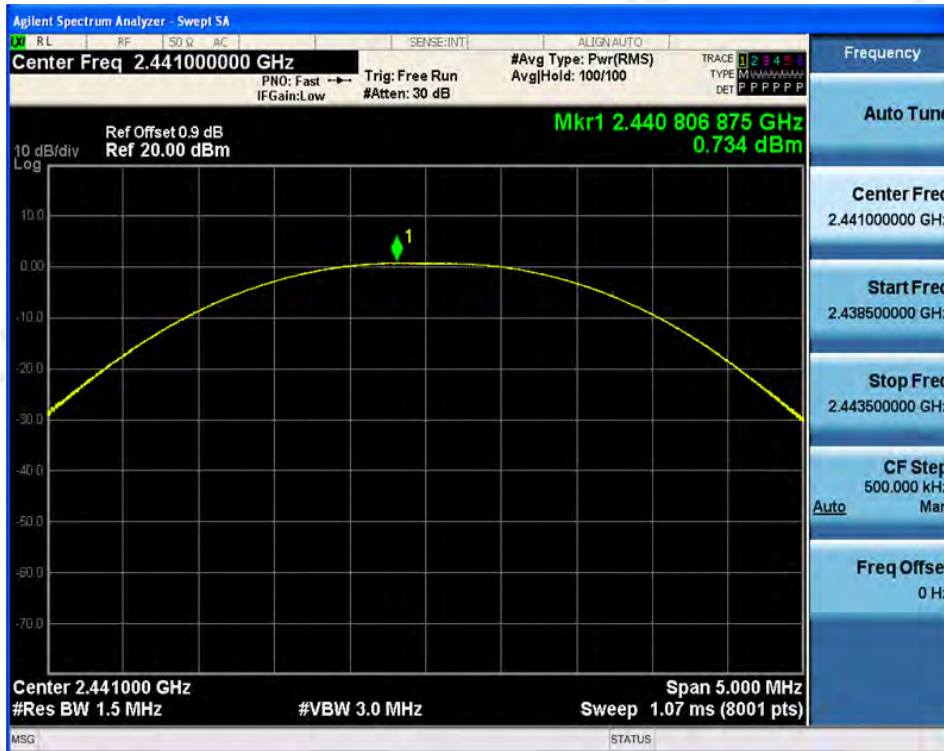

#### CH78

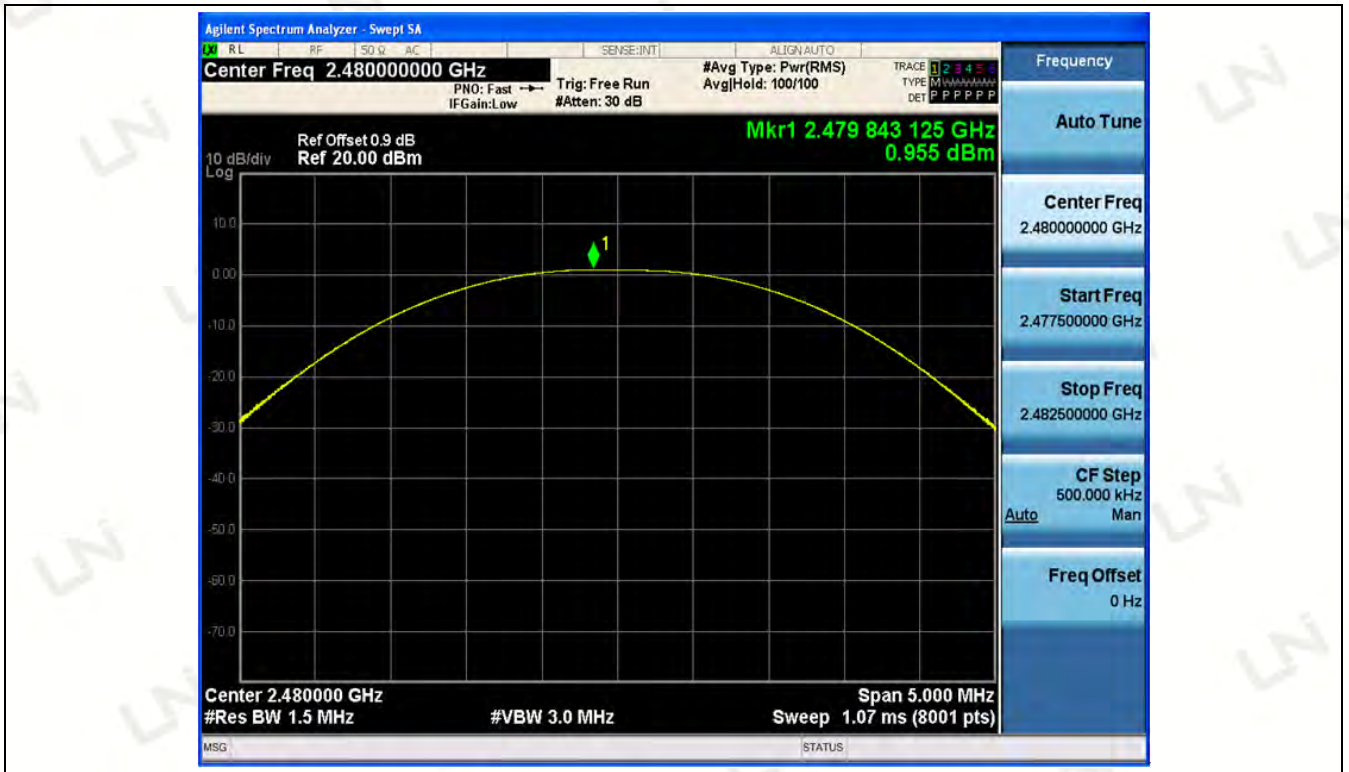

$\pi/4$ DQPSK Modulation

CH00

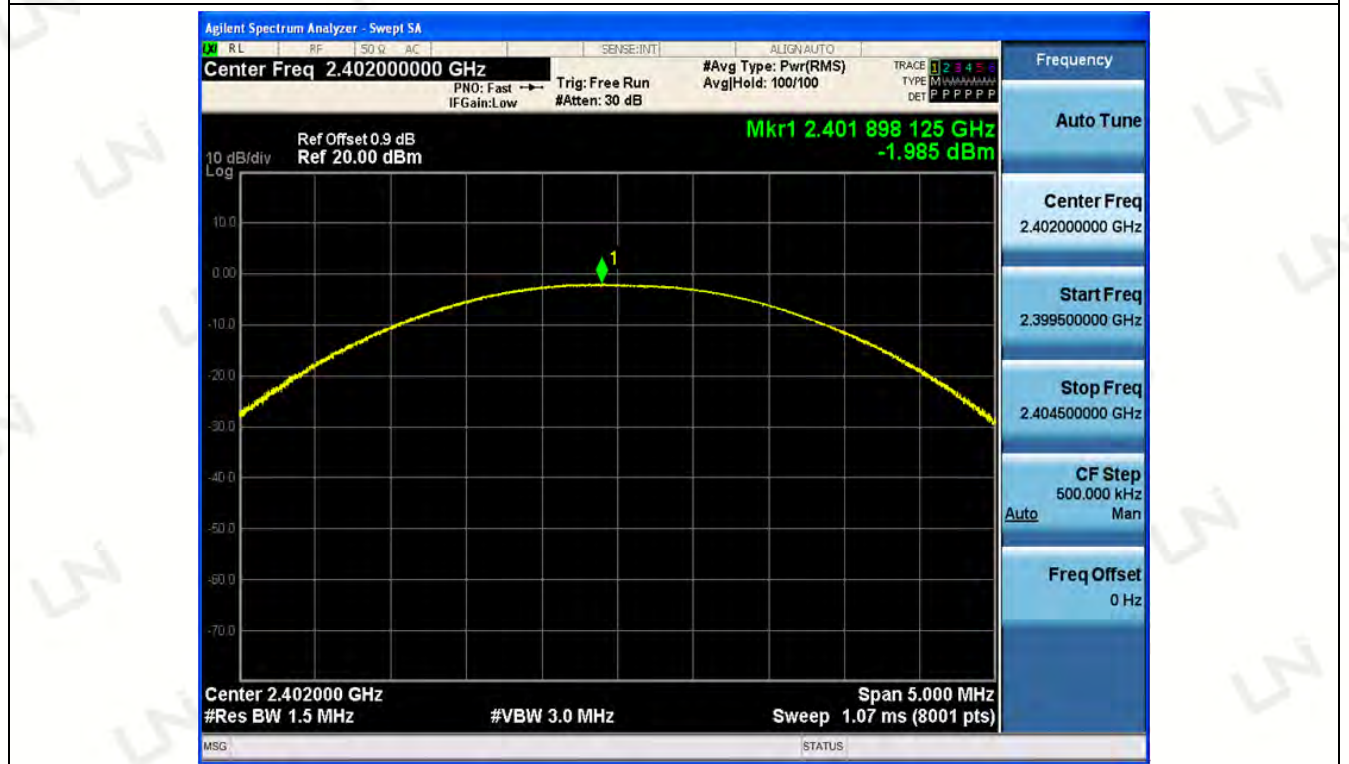

CH39

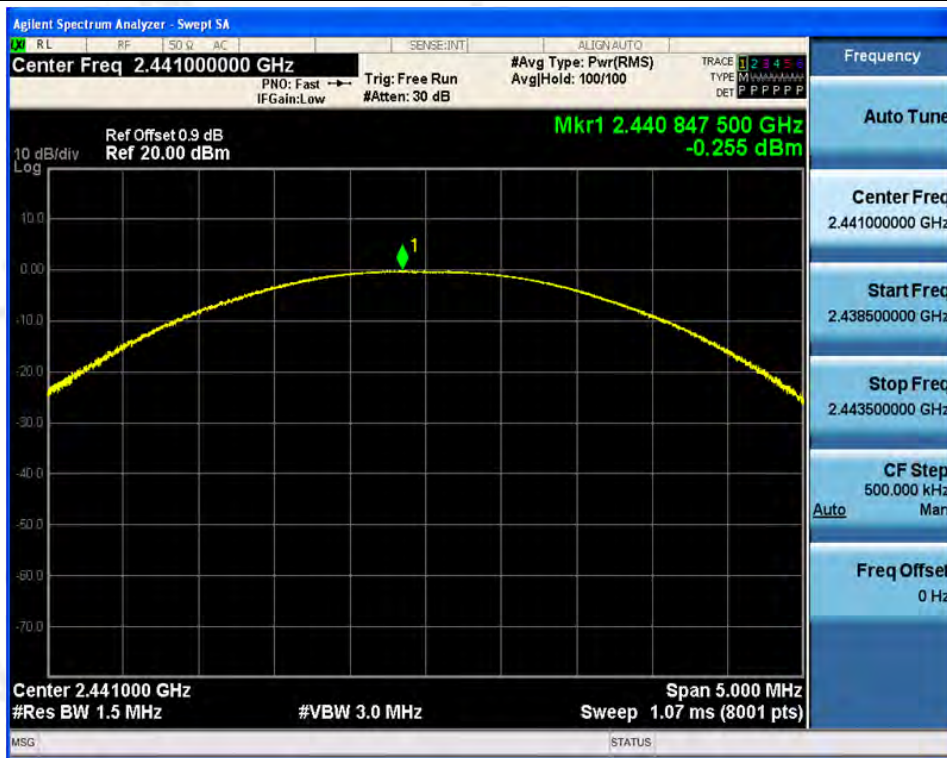

CH78

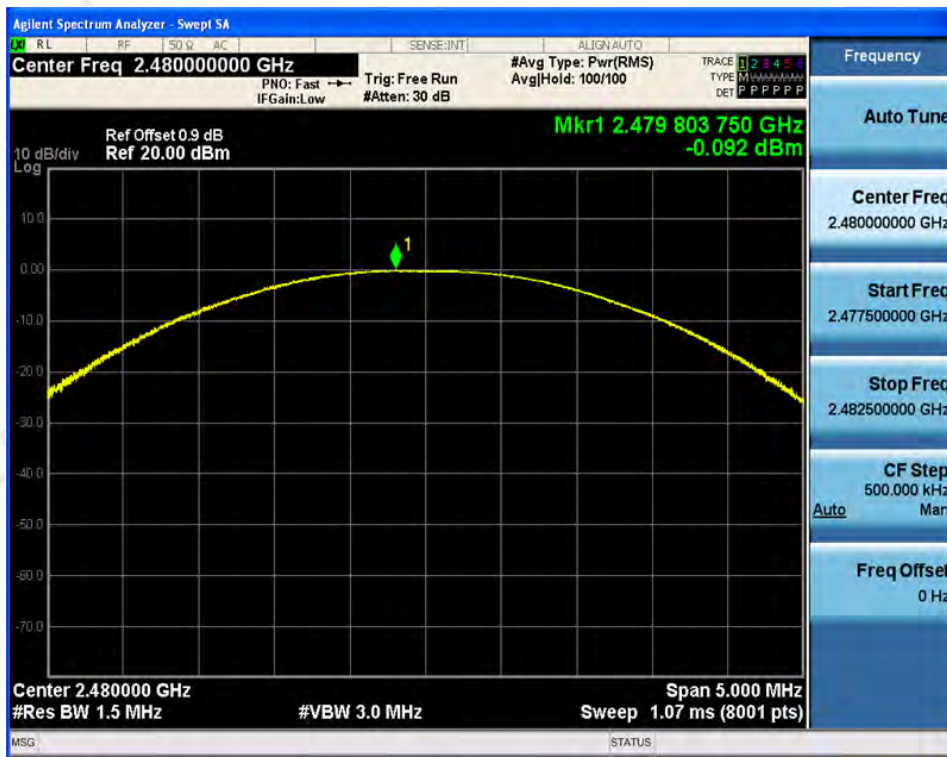

8DPSK Modulation

CH00

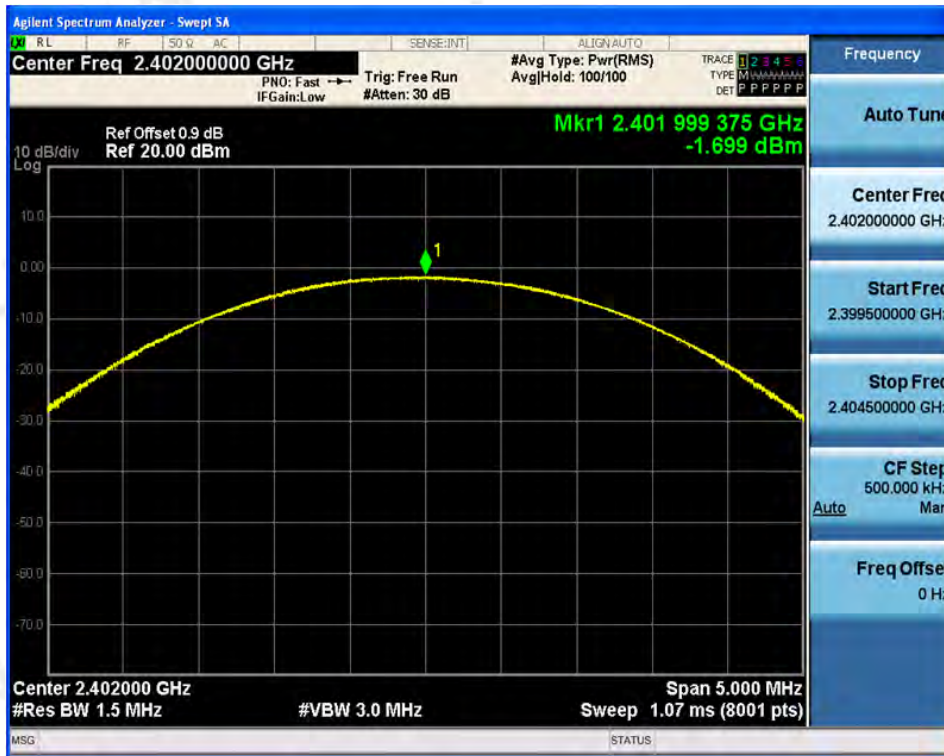

CH39

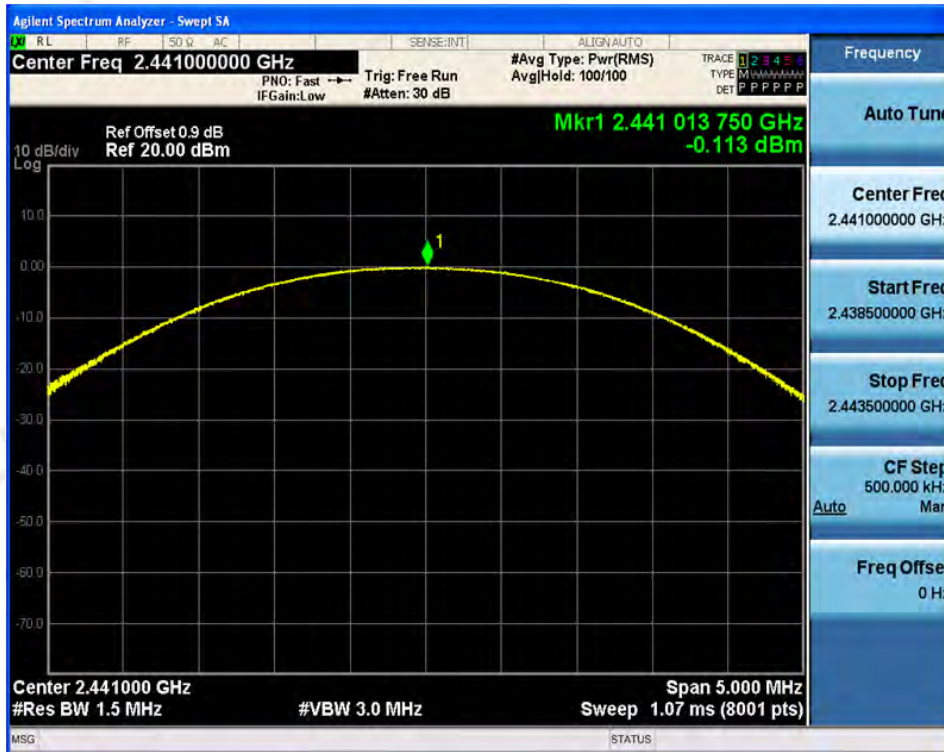

CH78



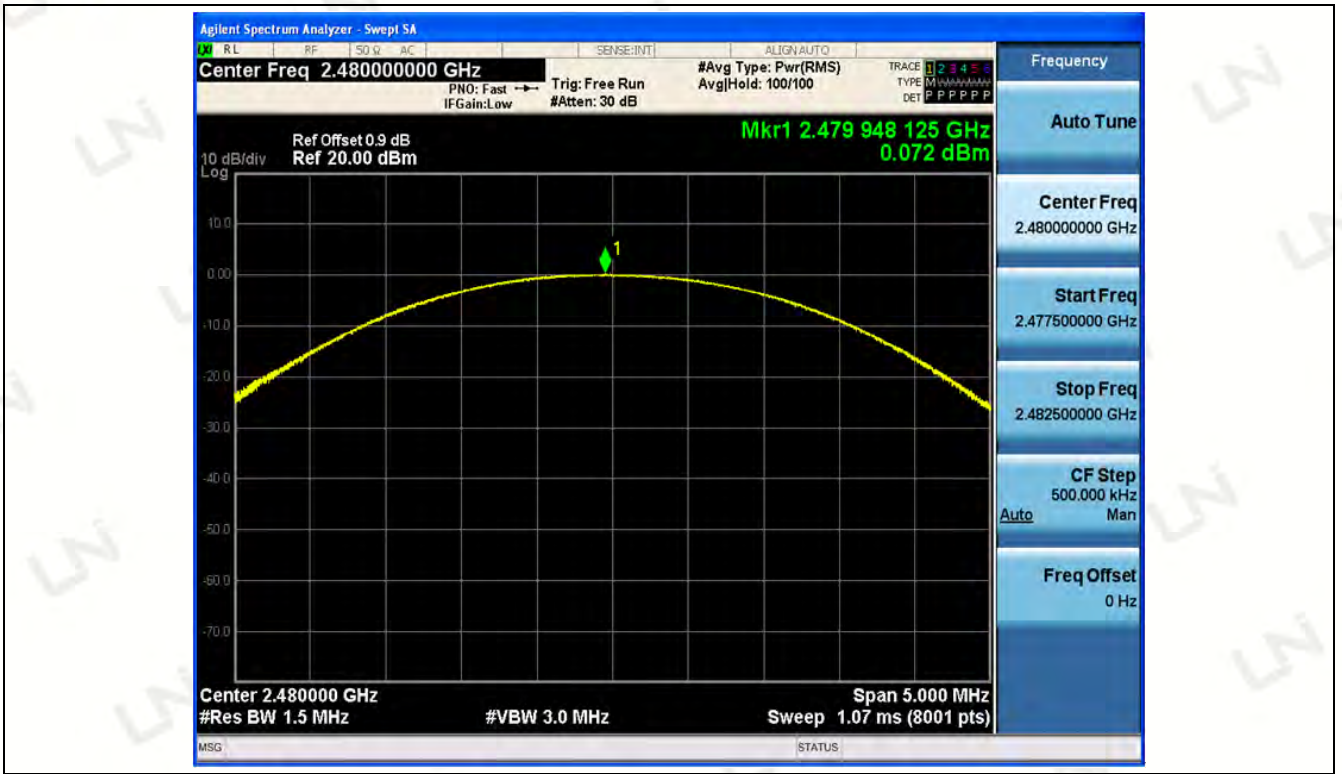

### 3.5 OCCUPIED BANDWIDTH MEASUREMENT

**Limit**

For frequency hopping systems operating in the 2400MHz - 2483.5MHz no limit for 20dB bandwidth.

**Test Procedure**

The transmitter output was connected to the spectrum analyzer through an attenuator. The bandwidth of the fundamental frequency was measured by spectrum analyzer with 30 KHz RBW and 100 KHz VBW. The 20dB bandwidth is defined as the total spectrum the power of which is higher than peak power minus 20dB.

**Test Configuration**

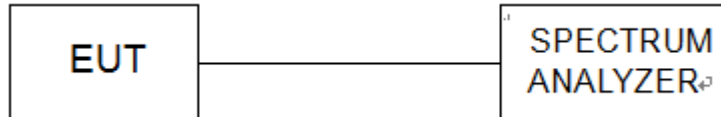

**Test Result**

---PASS---

Modulation	Channel	20dB bandwidth (MHz)	99% OBW (MHz)	Result
GFSK	CH00	0.9395	0.86883	Pass
	CH39	0.9507	0.85952	
	CH78	0.9359	0.86139	
π/4DQPSK	CH00	1.224	1.1692	
	CH39	1.230	1.1850	
	CH78	1.306	1.1788	
8DPSK	CH00	1.258	1.1686	
	CH39	1.261	1.1786	
	CH78	1.261	1.1895	

### GFSK Modulation

#### CH00



#### CH39



#### CH78



$\pi/4$ DQPSK Modulation

CH00

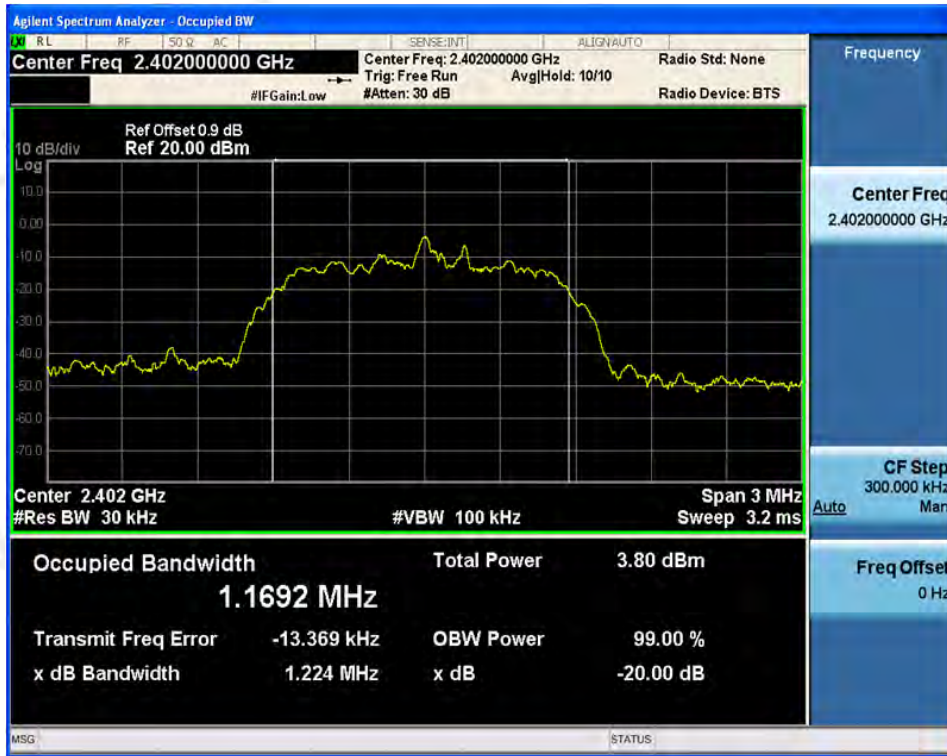

CH39

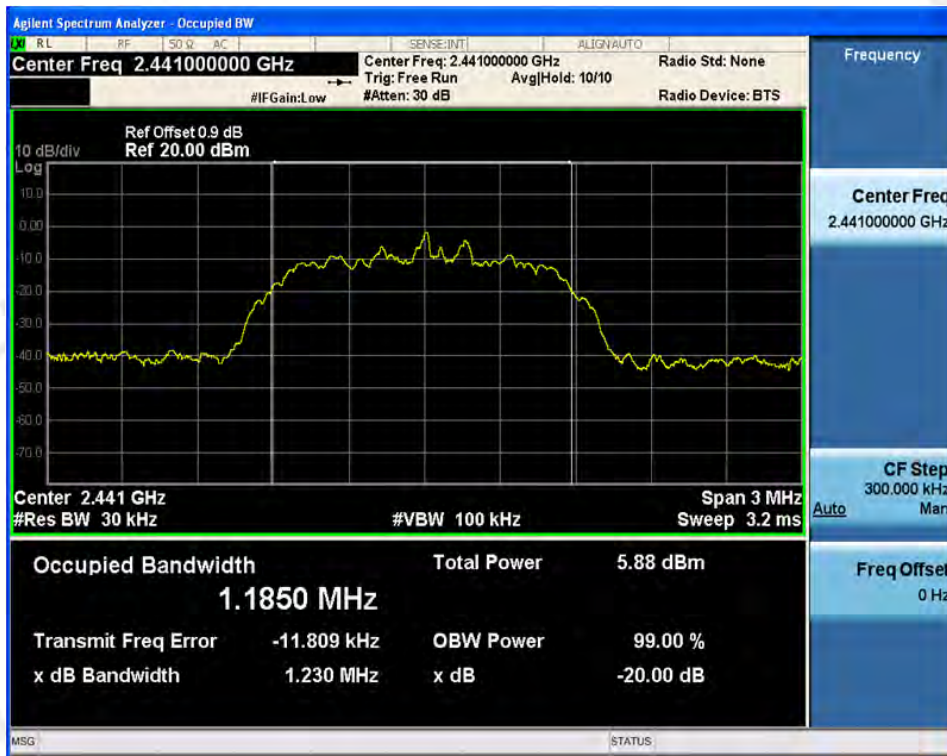

CH78

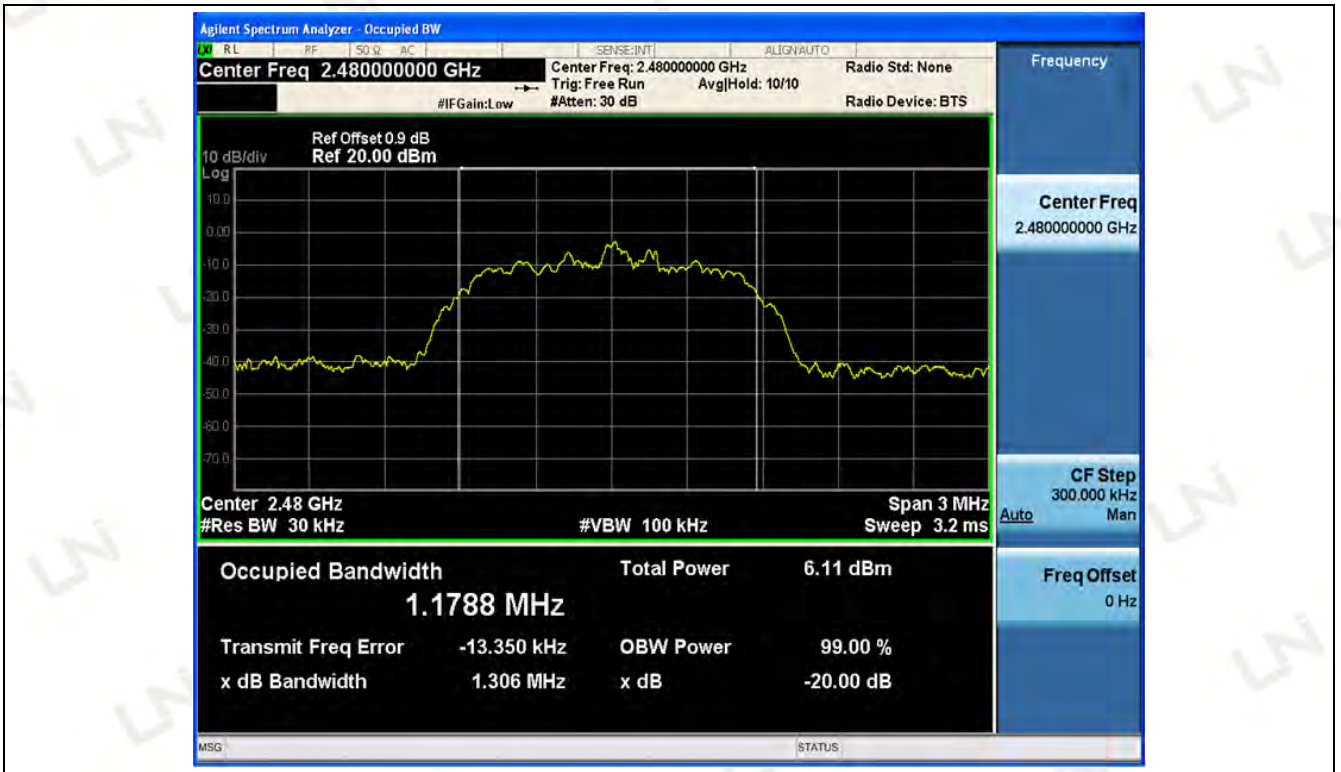

**8DPSK Modulation**

**CH00**

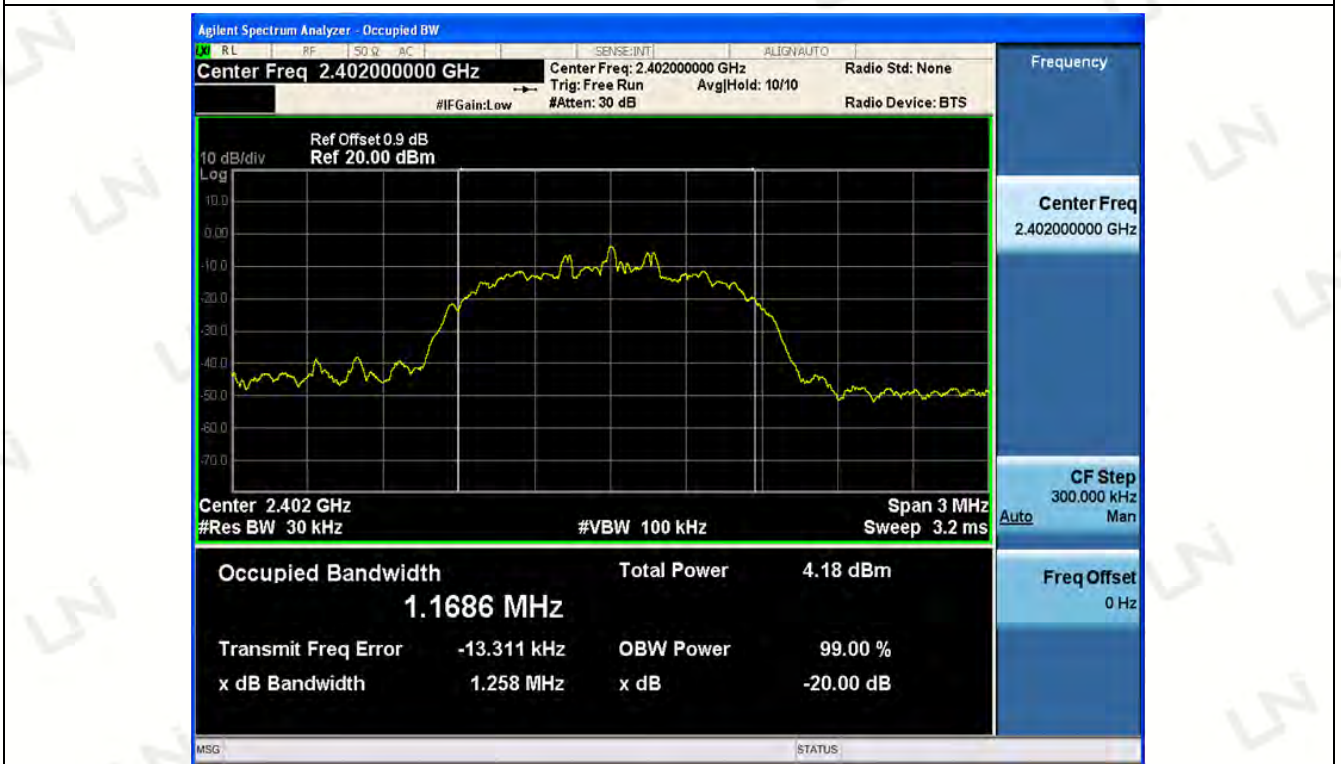

**CH39**

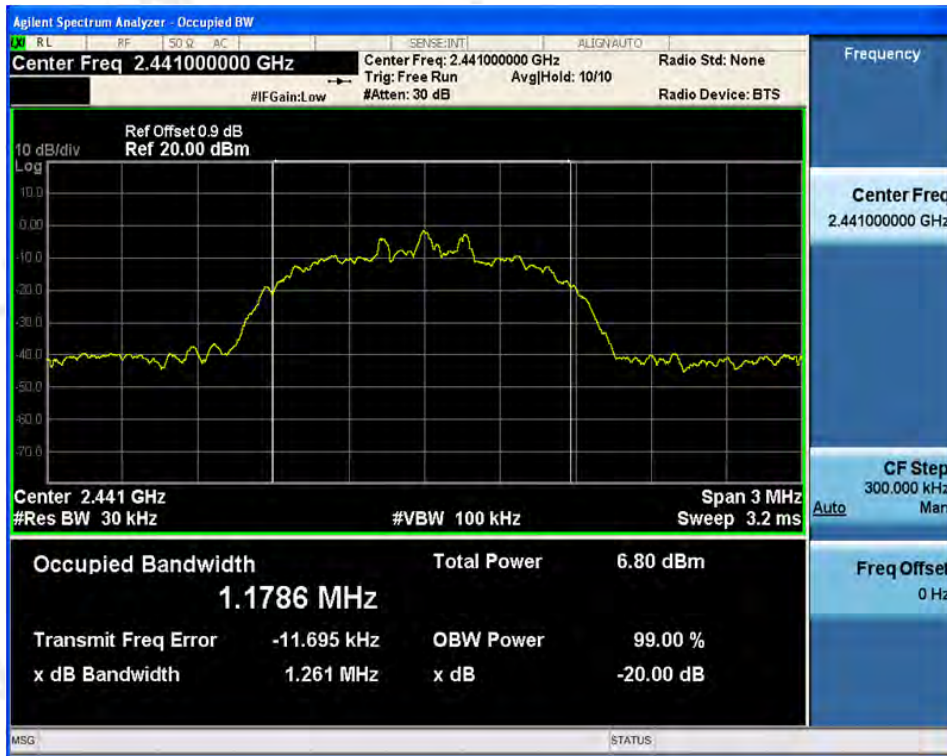

CH78

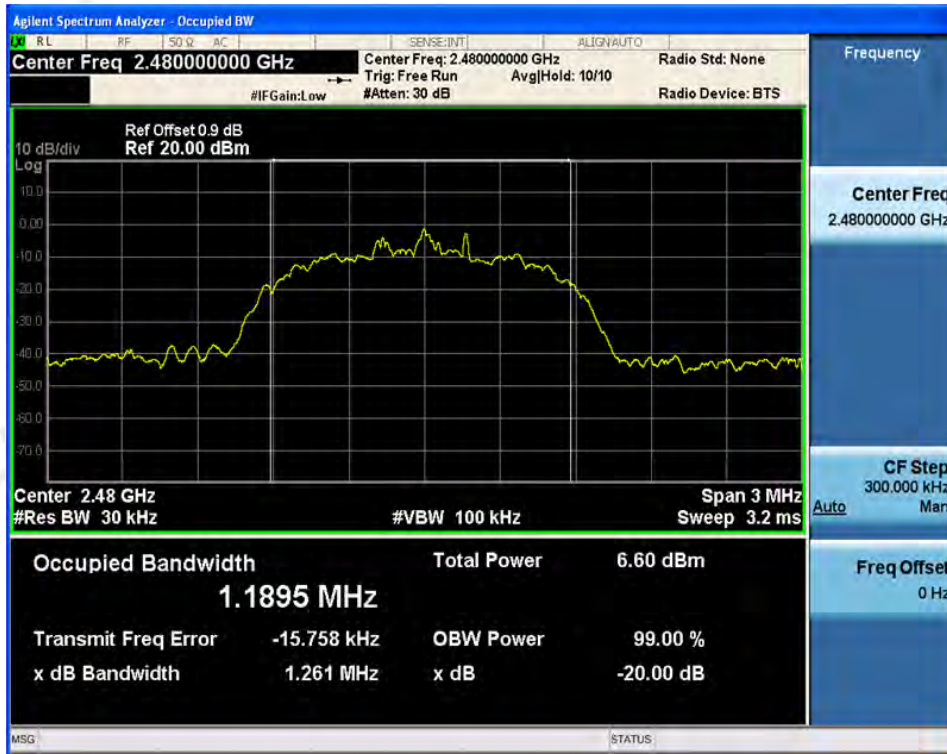

### 3.6 Frequency Separation

#### LIMIT

According to 15.247(a)(1), frequency hopping systems shall have hopping channel carrier frequencies separated by minimum of 25KHz or the  $2/3 \times 20\text{dB}$  bandwidth of the hopping channel, whichever is greater.

#### TEST PROCEDURE

The transmitter output was connected to the spectrum analyzer through an attenuator. The bandwidth of the fundamental frequency was measured by spectrum analyzer with 100 KHz RBW and 300 KHz VBW.

#### Test Configuration



#### TEST RESULTS

Modulation	Channel	Channel Separation (MHz)	Limit(MHz)	Result
GFSK	CH38	1.038	25KHz or $2/3 \times 20\text{dB}$ bandwidth	Pass
	CH39			
$\pi/4$ DQPSK	CH38	1.034	25KHz or $2/3 \times 20\text{dB}$ bandwidth	Pass
	CH39			
8DPSK	CH38	1.008	25KHz or $2/3 \times 20\text{dB}$ bandwidth	Pass
	CH39			

Note:

We have tested all mode at high, middle and low channel, and recorded worst case at middle



### GFSK Modulation



### $\pi/4$ DQPSK Modulation

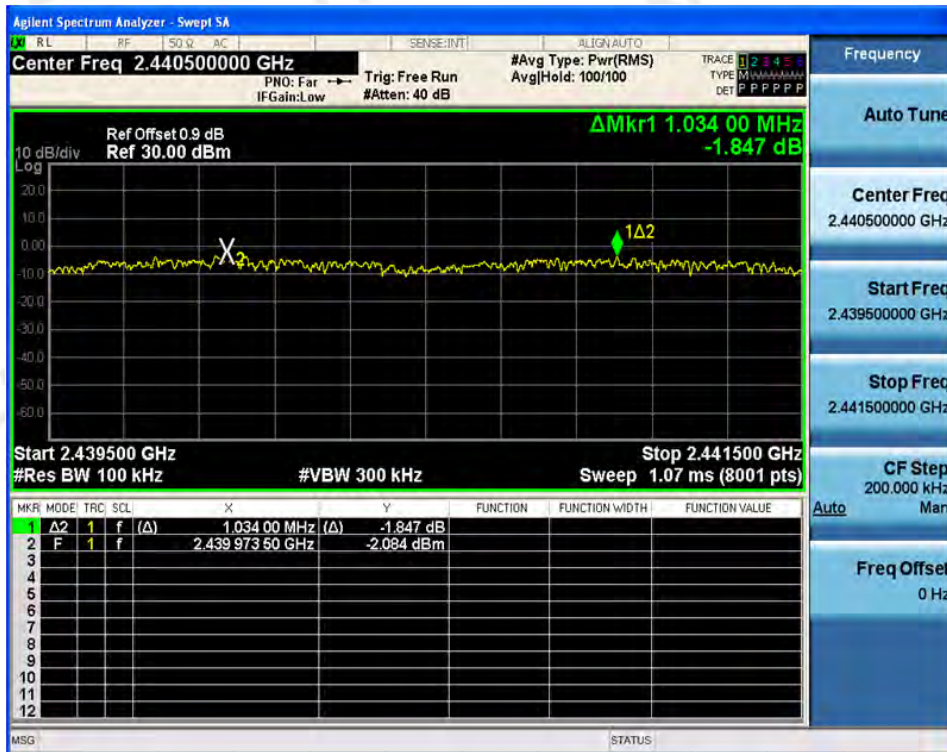

### 8DPSK Modulation

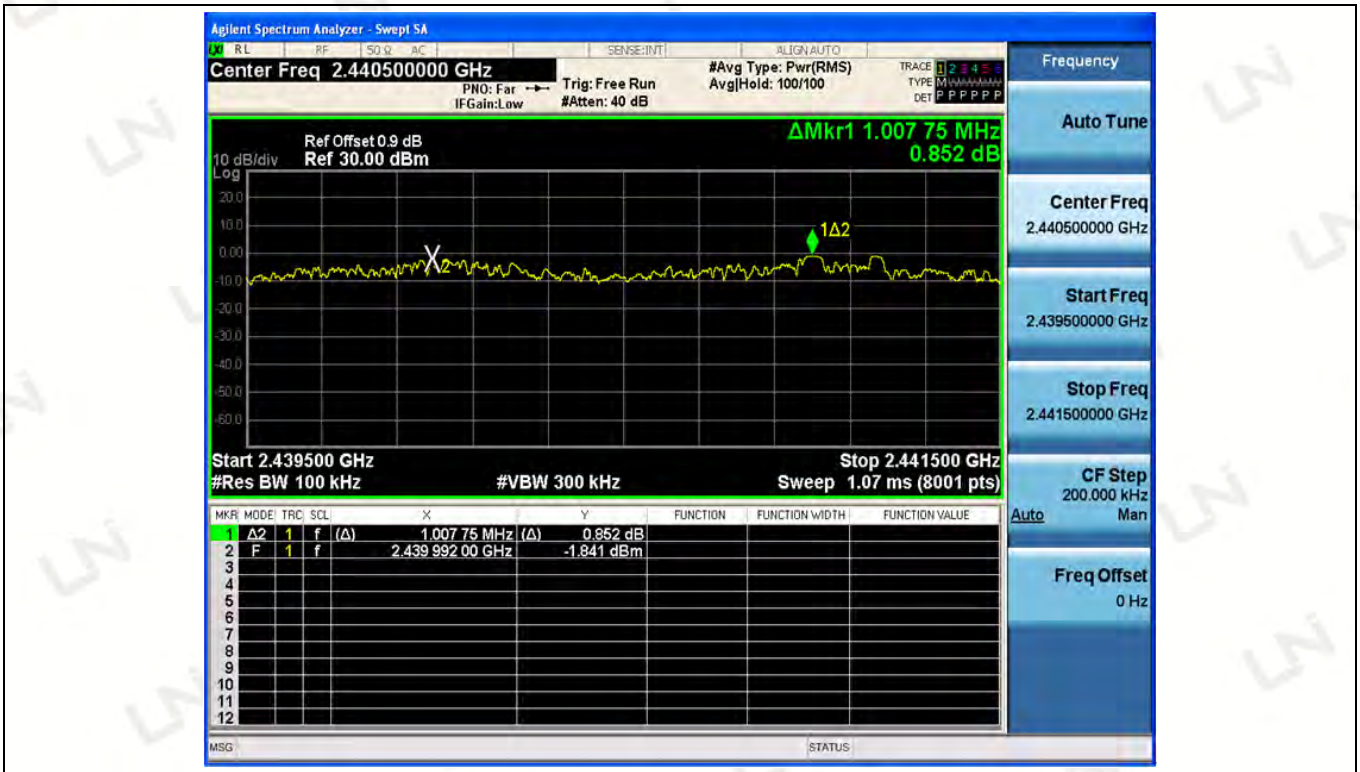

### 3.7 Number of hopping frequency

#### Limit

Frequency hopping systems in the 2400–2483.5 MHz band shall use at least 15 channels.

#### Test Procedure

The transmitter output was connected to the spectrum analyzer through an attenuator. Set spectrum analyzer start 2400MHz to 2483.5MHz with 100 KHz RBW and 300 KHz VBW.

#### Test Configuration

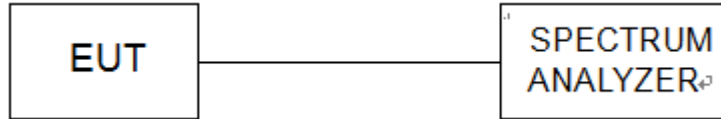

#### Test Results

Modulation	Number of Hopping Channel	Limit	Result
GFSK	79	≥15	Pass
$\pi/4$ DQPSK	79		
8DPSK	79		

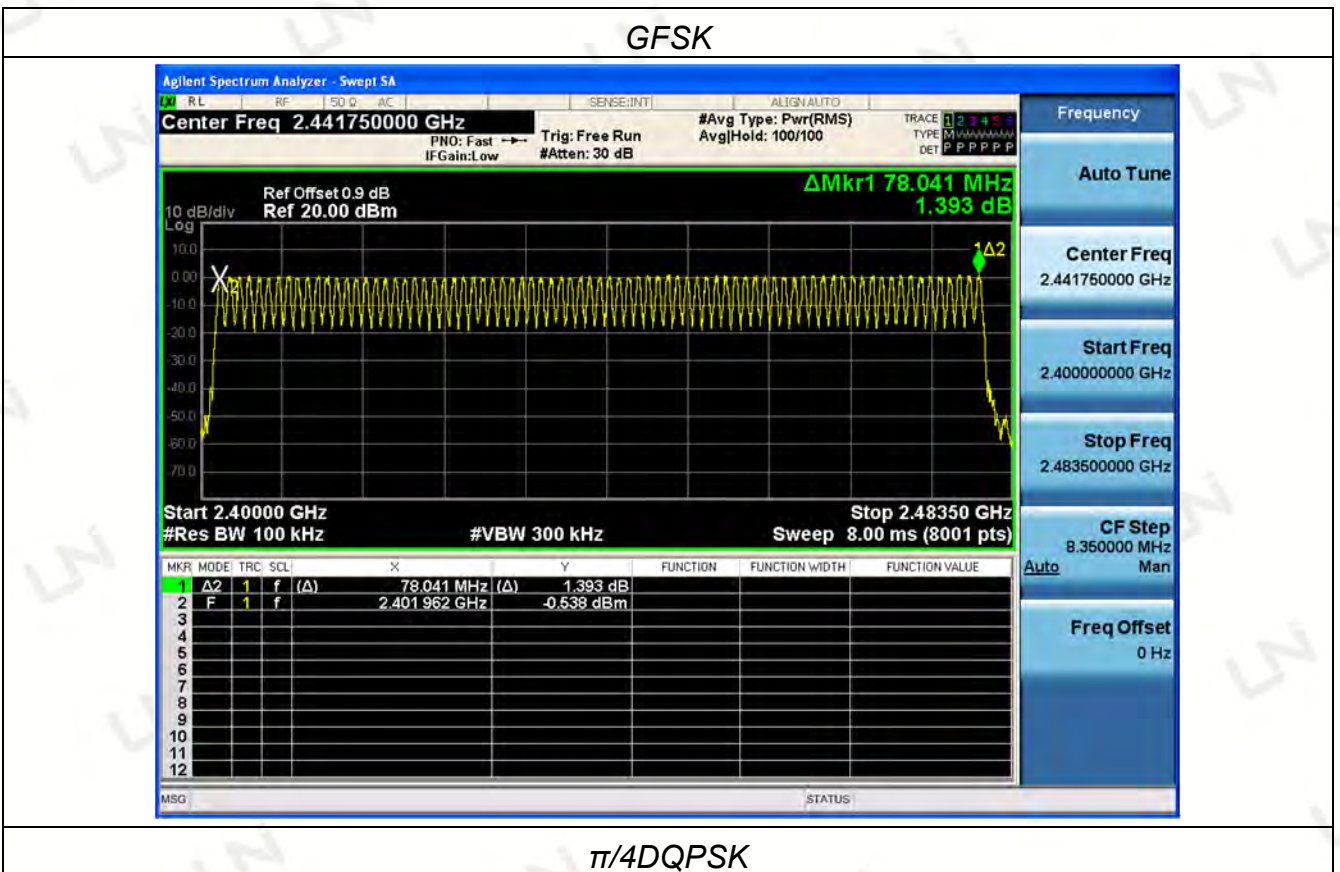

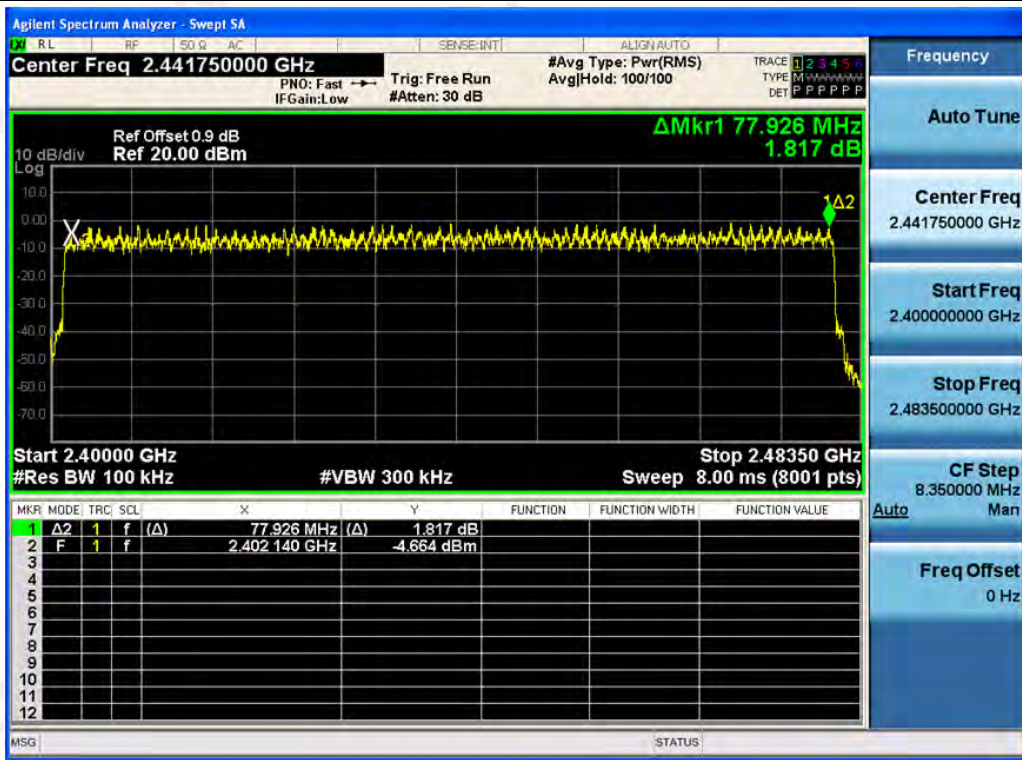

8DPSK

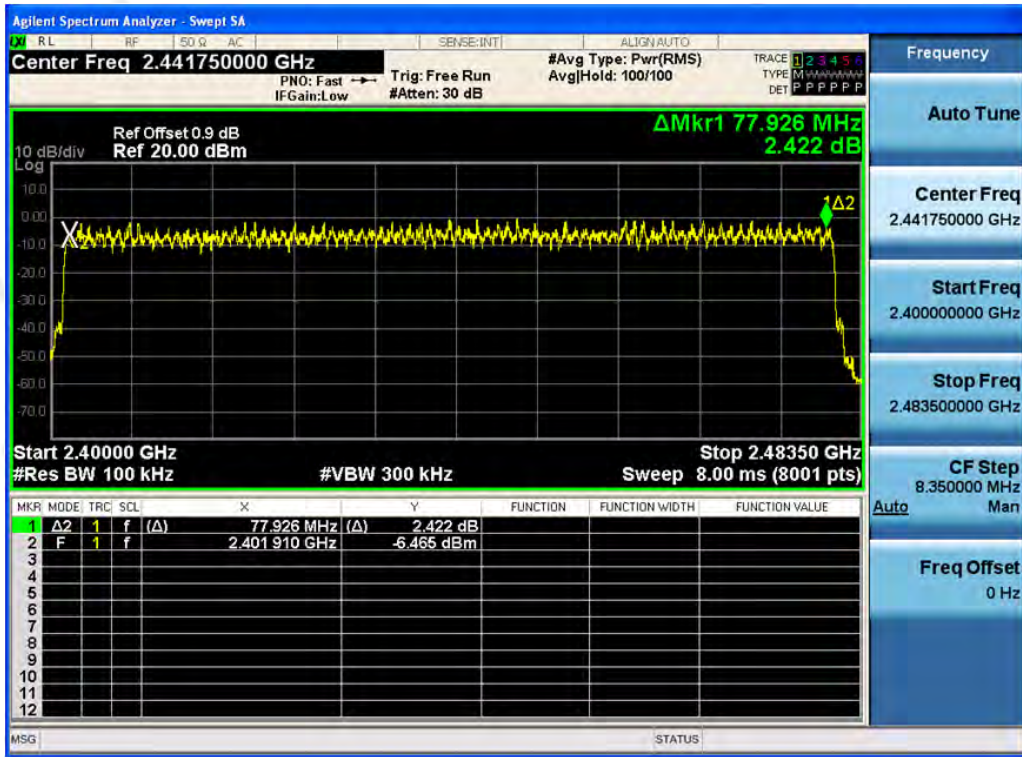

### 3.8 Time of Occupancy (Dwell Time)

#### Limit

The average time of occupancy on any channel shall not be greater than 0.4 seconds within a period of 0.4 seconds multiplied by the number of hopping channels employed.

#### Test Procedure

The transmitter output was connected to the spectrum analyzer through an attenuator. Set center frequency of spectrum analyzer=operating frequency with 1MHz RBW and 1MHz VBW, Span 0Hz.

#### Test Configuration



#### Test Results

Modulation	Packet	Pulse time (ms)	Dwell time (s)	Limit (s)	Result
GFSK	DH1	0.4115	0.1317	0.40	Pass
	DH3	1.6660	0.2666		
	DH5	2.9145	0.3109		
π/4DQPSK	2-DH1	0.4220	0.1350	0.40	Pass
	2-DH3	1.6930	0.2709		
	2-DH5	2.9210	0.3116		
8DPSK	3-DH1	0.4225	0.1352	0.40	Pass
	3-DH3	1.6700	0.2672		
	3-DH5	2.9206	0.3115		

Note:

- We have tested all mode at high,middle and low channel,and recoreded worst case at middle channel.
- $Dwell\ time = Pulse\ time\ (ms) \times (1600 \div 2 \div 79) \times 31.6\ Second$  for DH1, 2-DH1, 3-DH1  
 $Dwell\ time = Pulse\ time\ (ms) \times (1600 \div 4 \div 79) \times 31.6\ Second$  for DH3, 2-DH3, 3-DH3  
 $Dwell\ time = Pulse\ time\ (ms) \times (1600 \div 6 \div 79) \times 31.6\ Second$  for DH5, 2-DH5, 3-DH5

### GFSK DH1

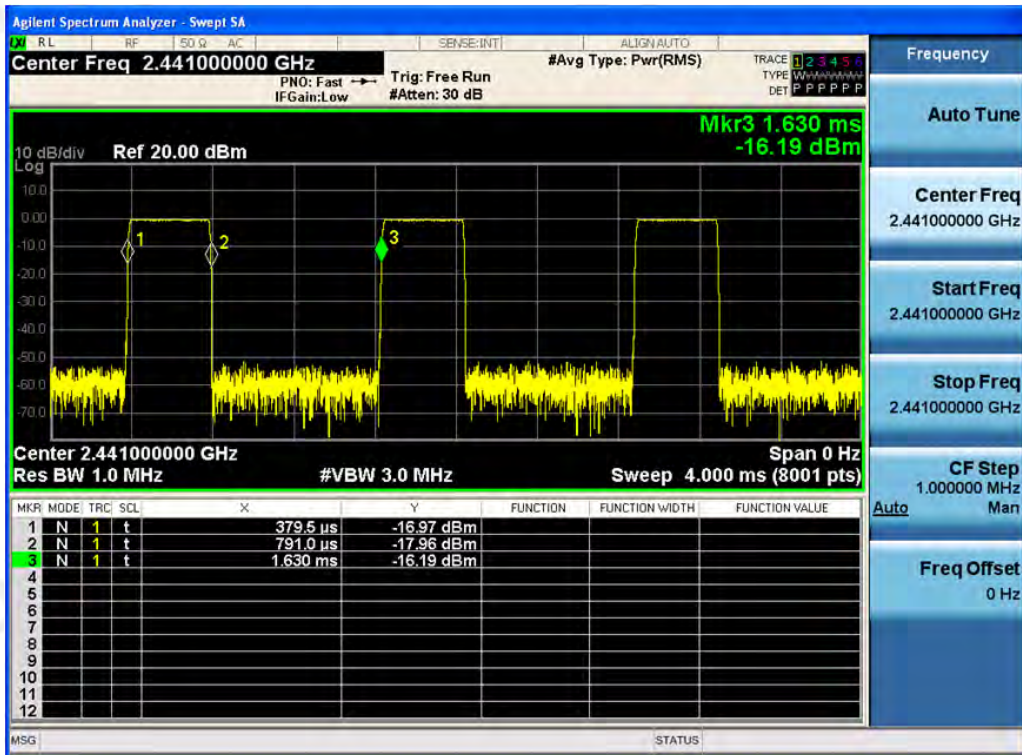

### DH3

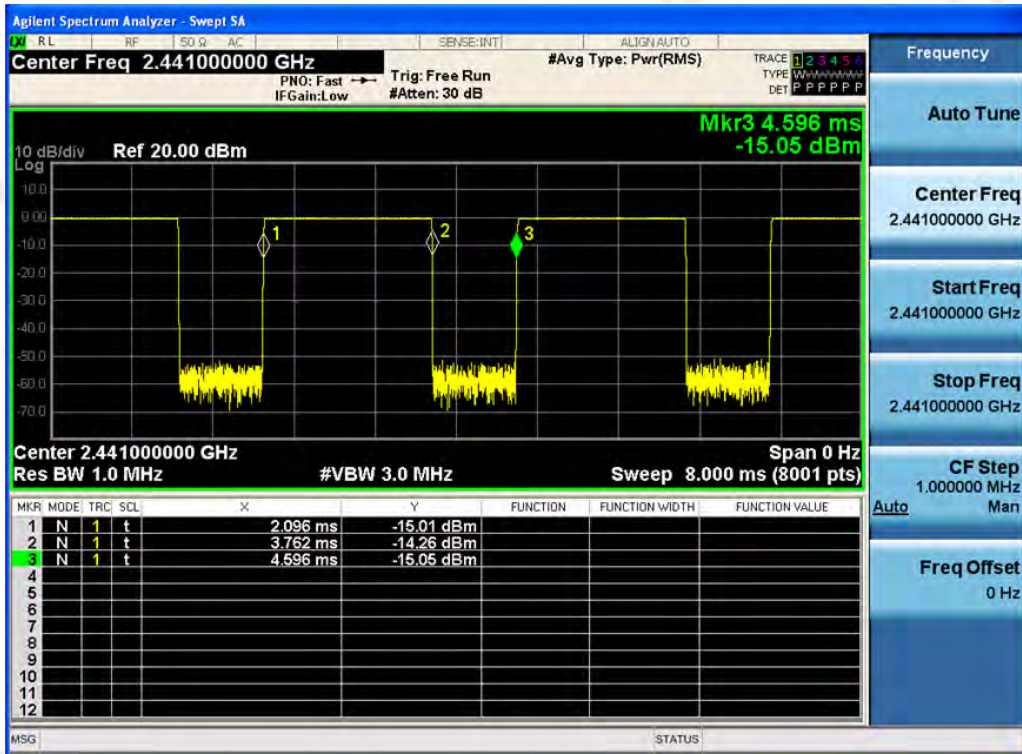

### DH5

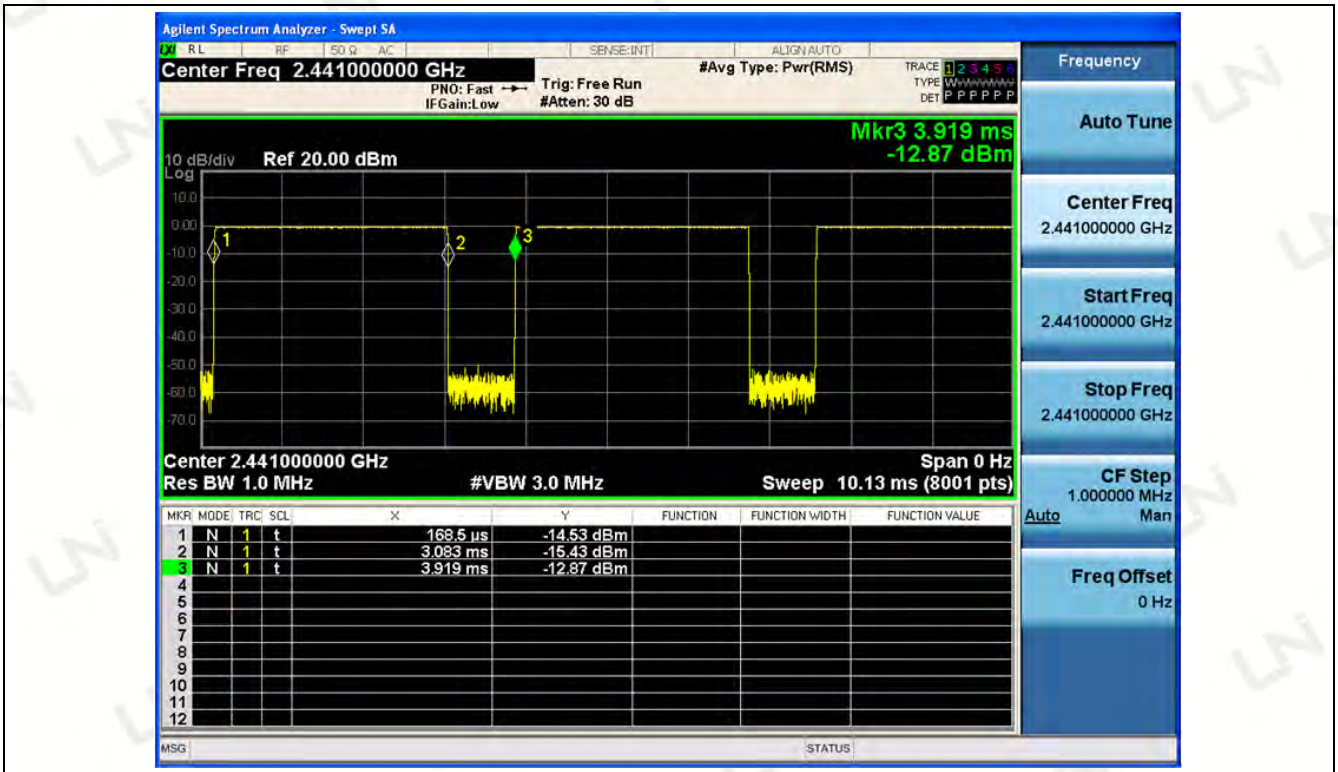

π/4DQPSK

2-DH1

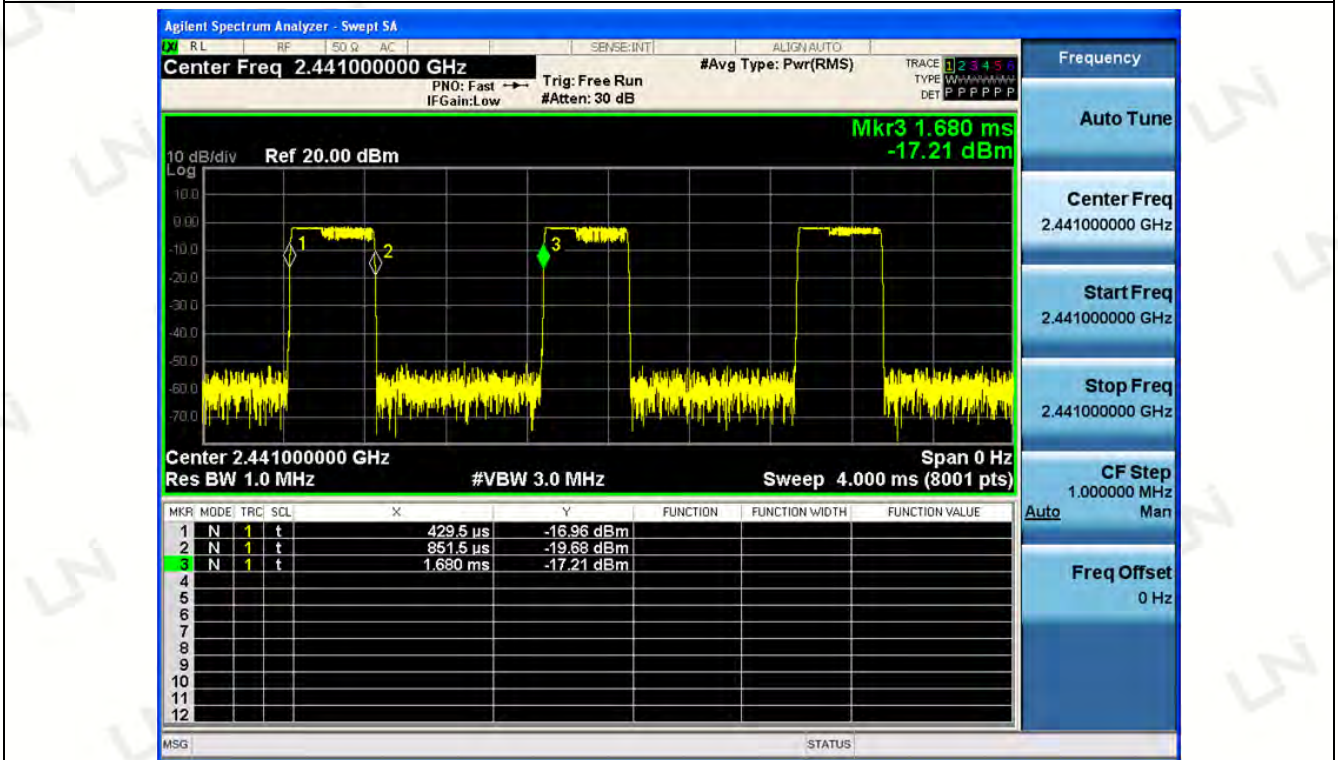

2-DH3

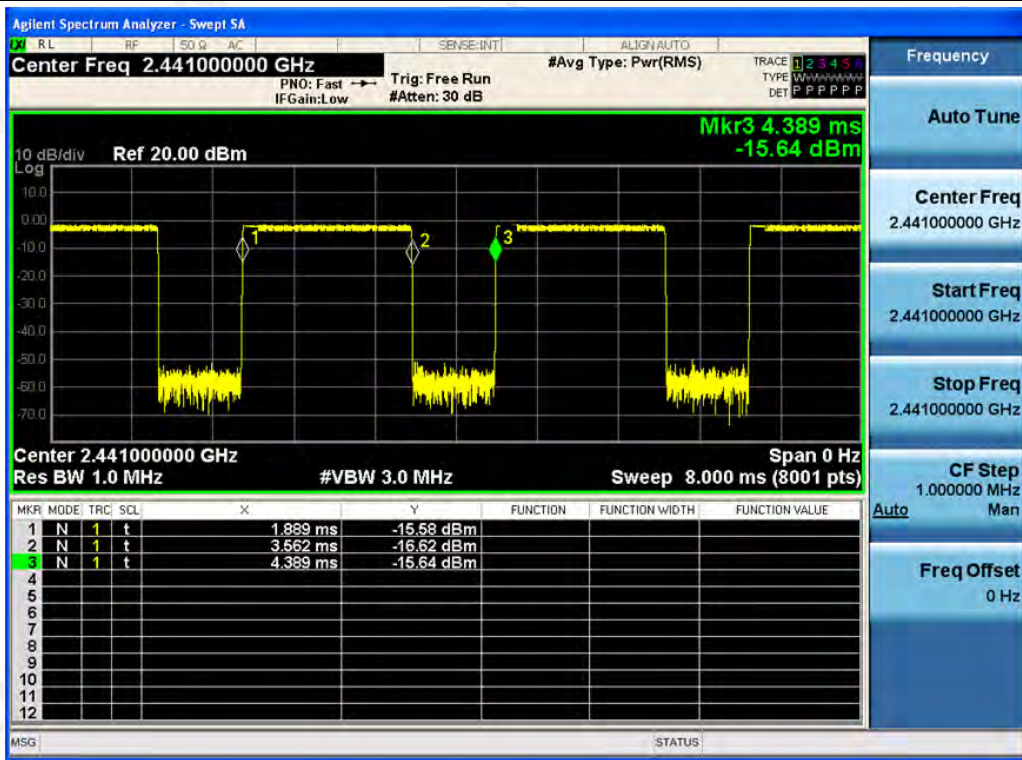

2-DH5

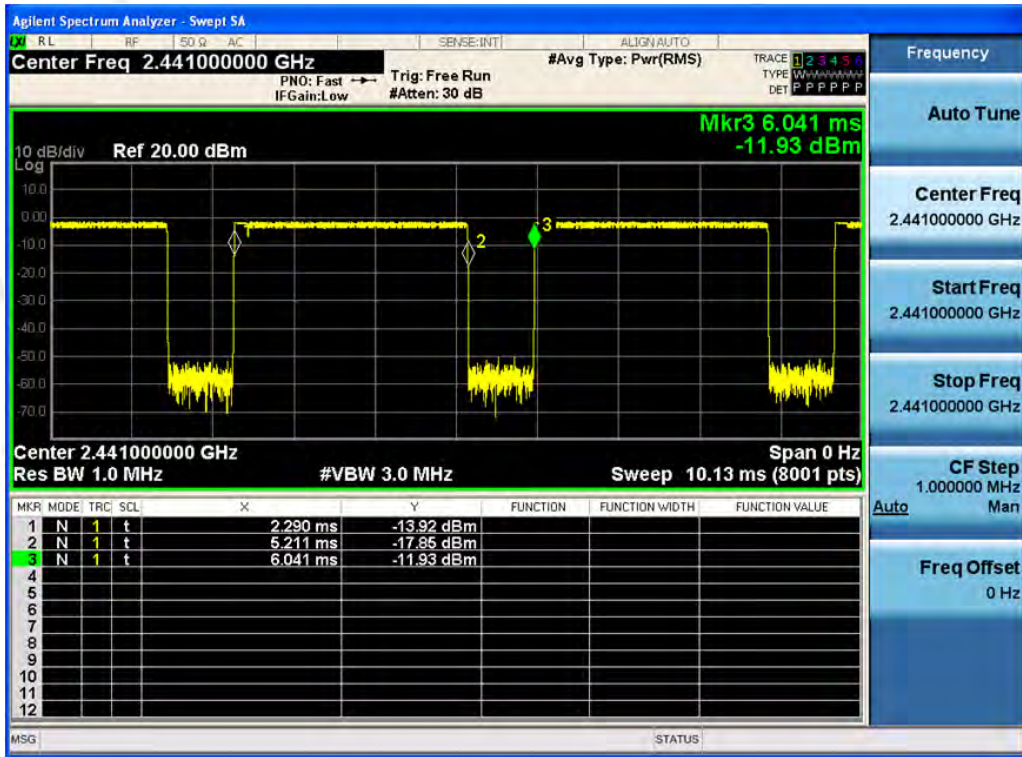



### 3-DH1

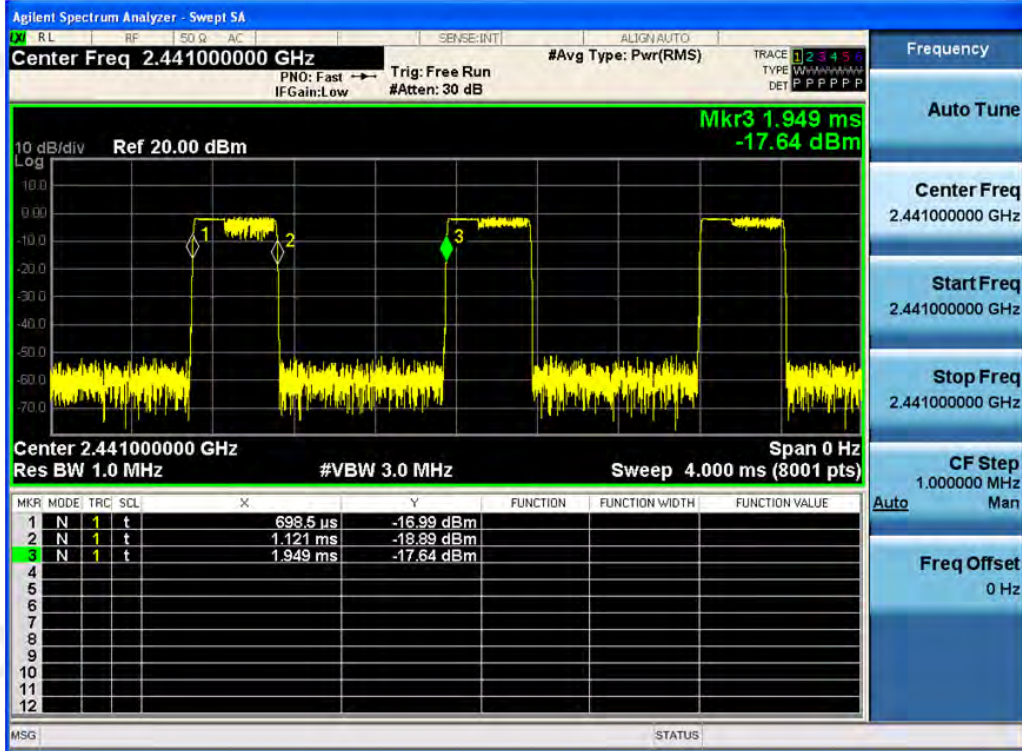

### 3-DH3

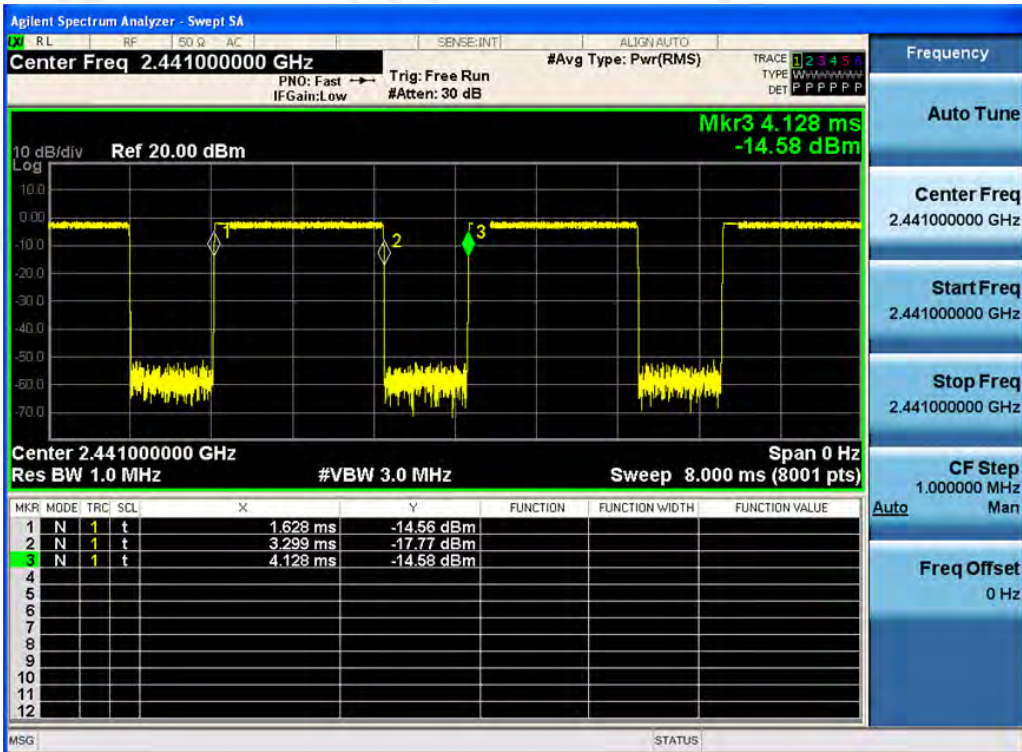

### 3-DH5

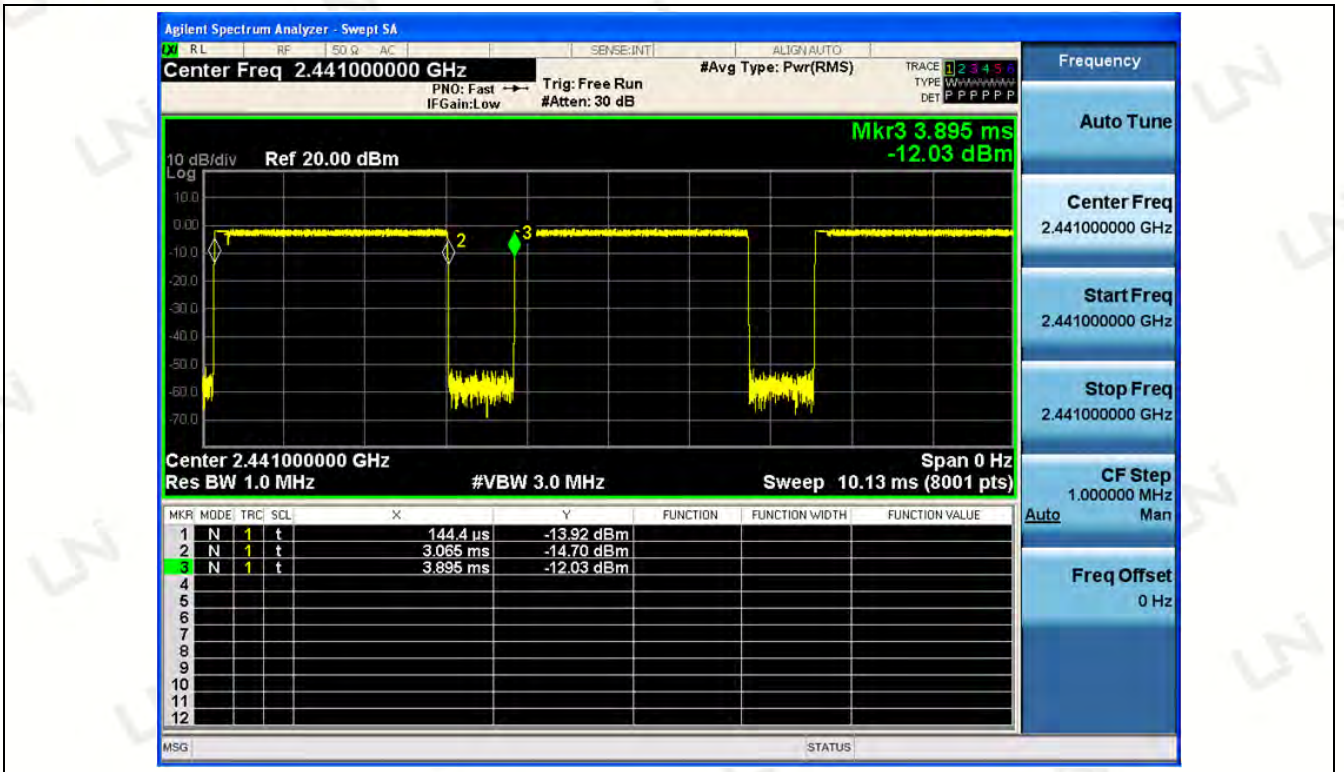

### 3.9 OUT-OF BAND EMISSIONS

#### Limit

In any 100 kHz bandwidth outside the frequency band in which the spread spectrum or digitally modulated intentional radiator is operating, the radio frequency power that is produced by the intentional radiator shall be at least 20 dB below that in the 100 kHz bandwidth within the band that contains the highest level of the desired power, based on either an RF conducted or a radiated measurement, provided the transmitter demonstrates compliance with the peak conducted power limits. If the transmitter complies with the conducted power limits based on the use of RMS averaging over a time interval, as permitted under paragraph (b)(3) of this section, the attenuation required under this paragraph shall be 30 dB instead of 20 dB. Attenuation below the general limits specified in §15.209(a) is not required.

#### Test Procedure

Connect the transmitter output to spectrum analyzer using a low loss RF cable, and set the spectrum analyzer to RBW=100 kHz, VBW= 300 kHz, peak detector, and max hold. Measurements utilizing these setting are made of the in-band reference level, bandedge and out-of-band emissions.

#### Test Configuration

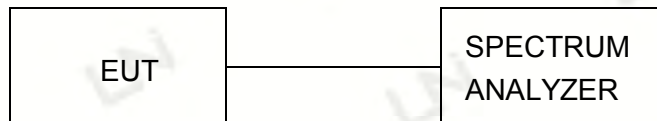

#### Test Results

Remark: The measurement frequency range is from 30MHz to the 10th harmonic of the fundamental frequency. The lowest, middle and highest channels are tested to verify the spurious emissions and bandage measurement data.

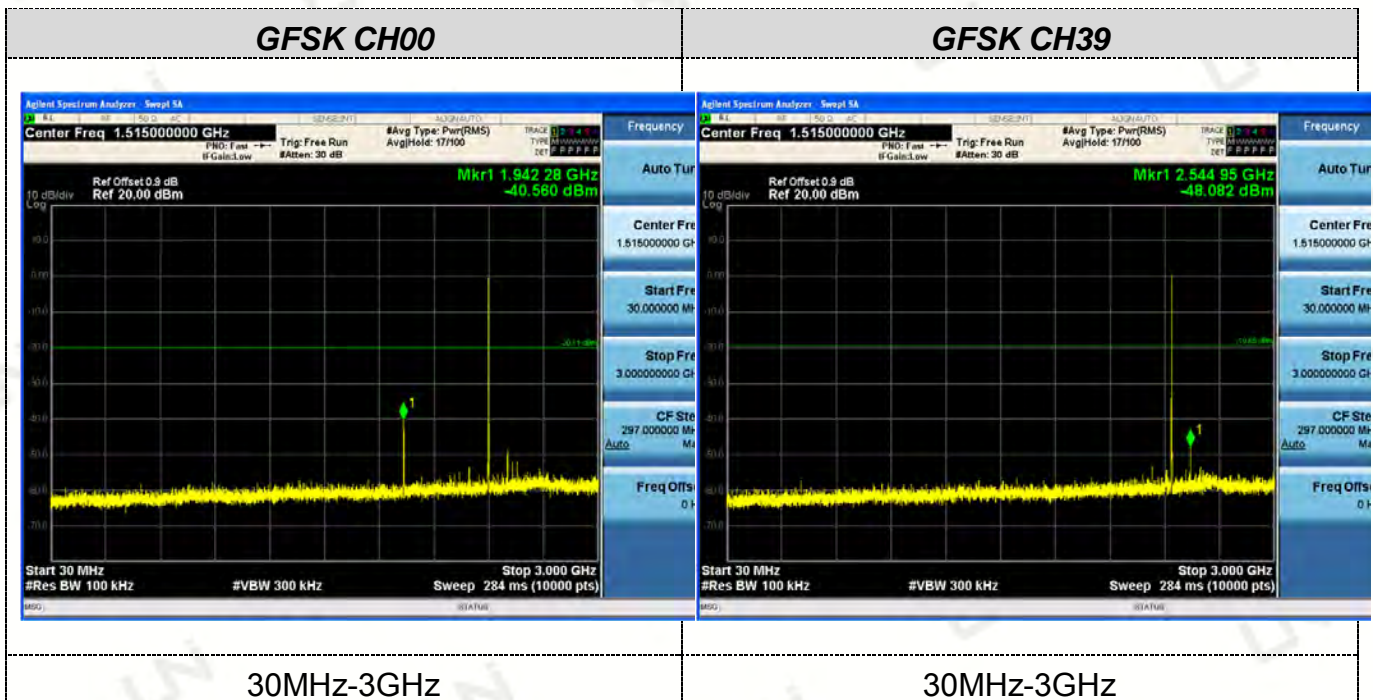

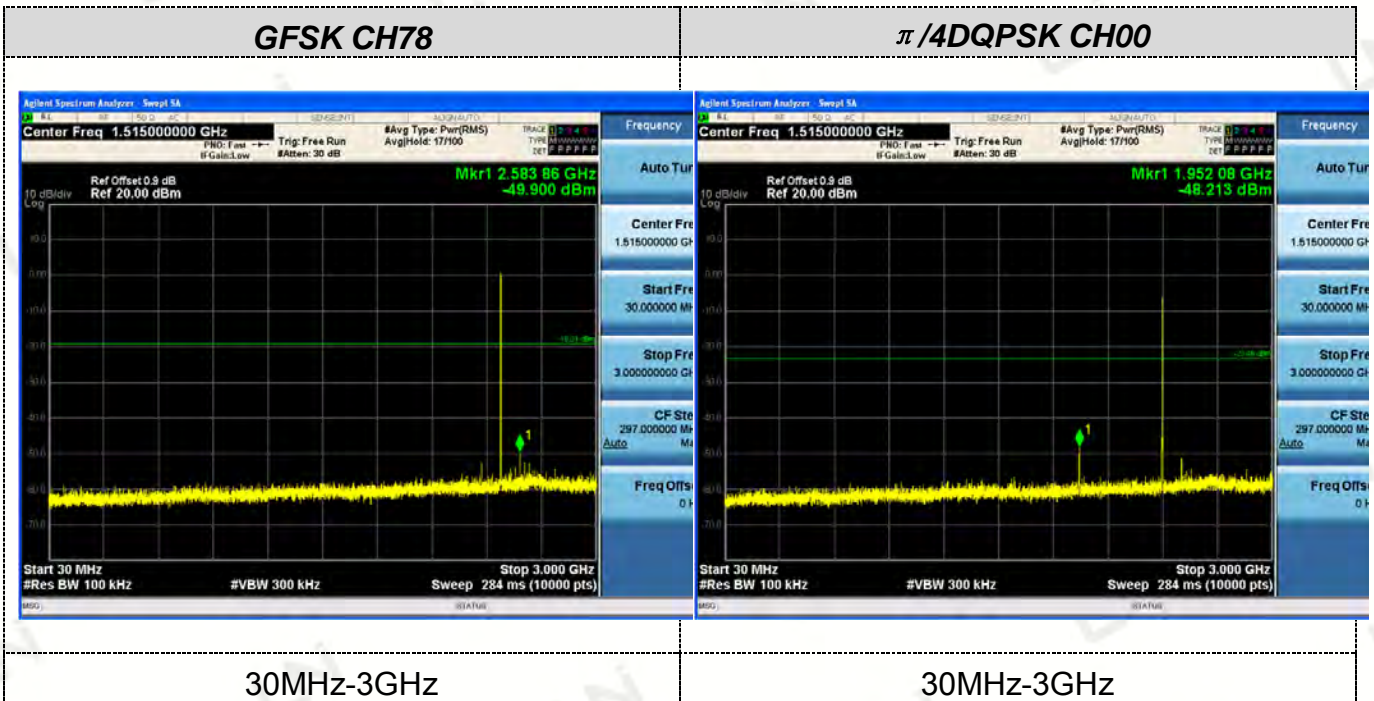
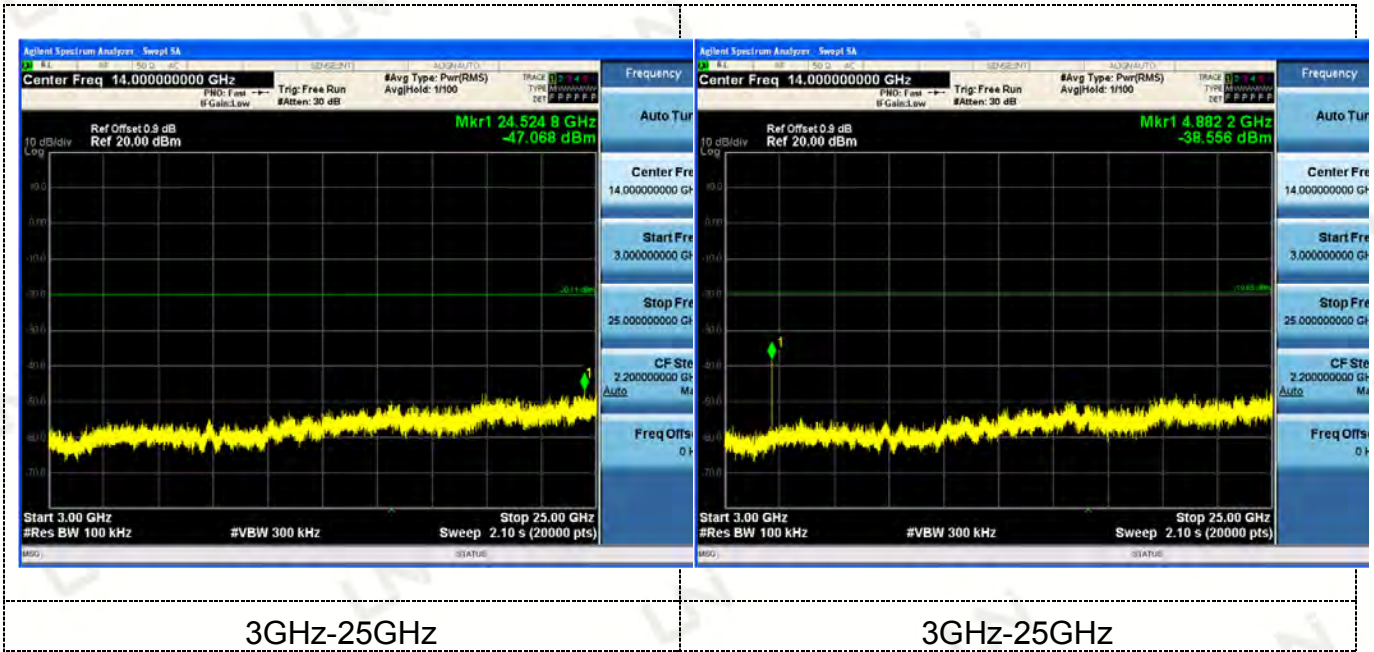

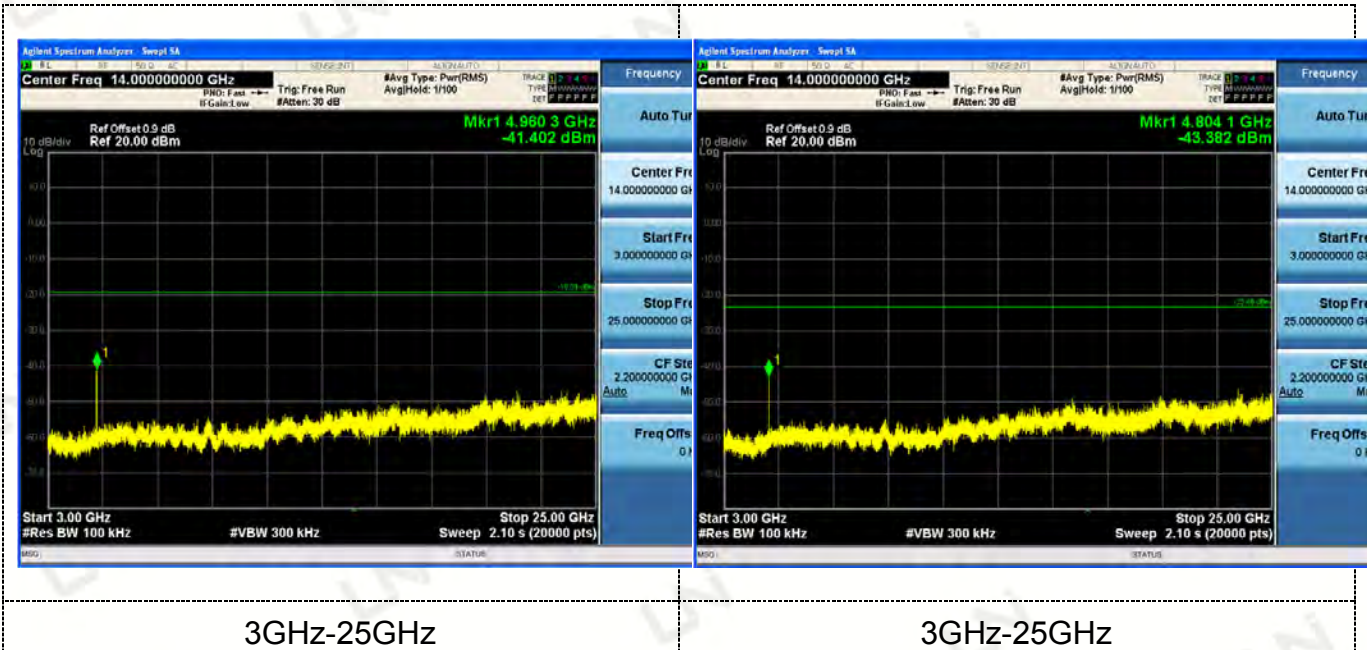

3GHz-25GHz

3GHz-25GHz

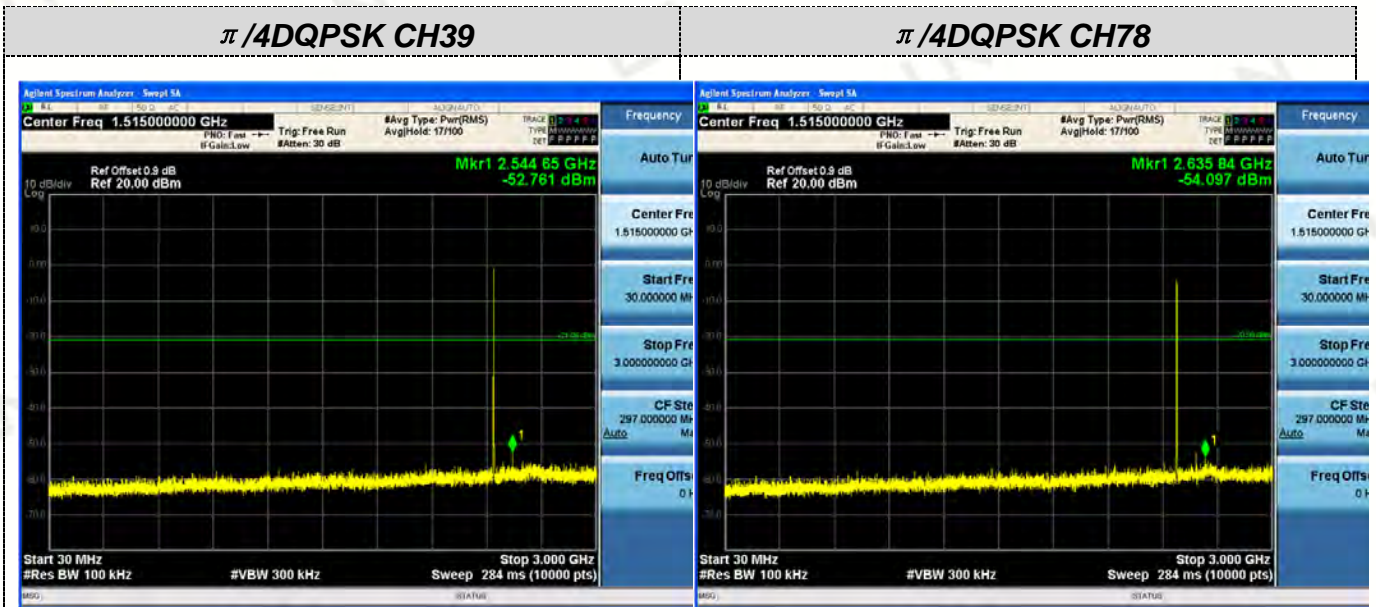

30MHz-3GHz

30MHz-3GHz

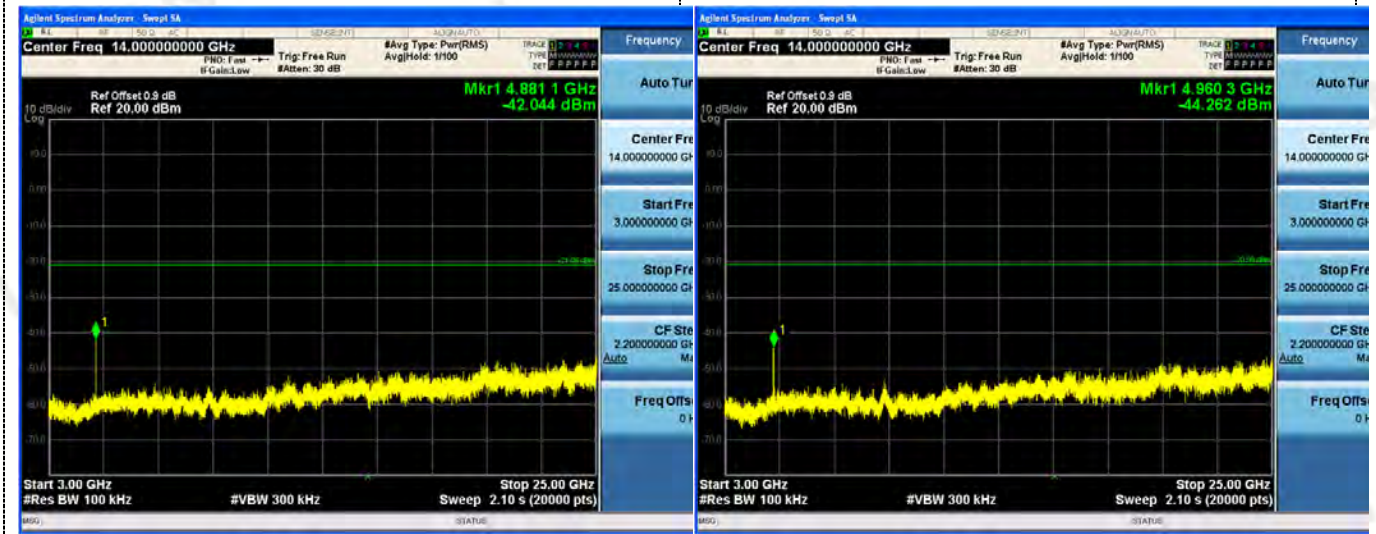

3GHz-25GHz

3GHz-25GHz

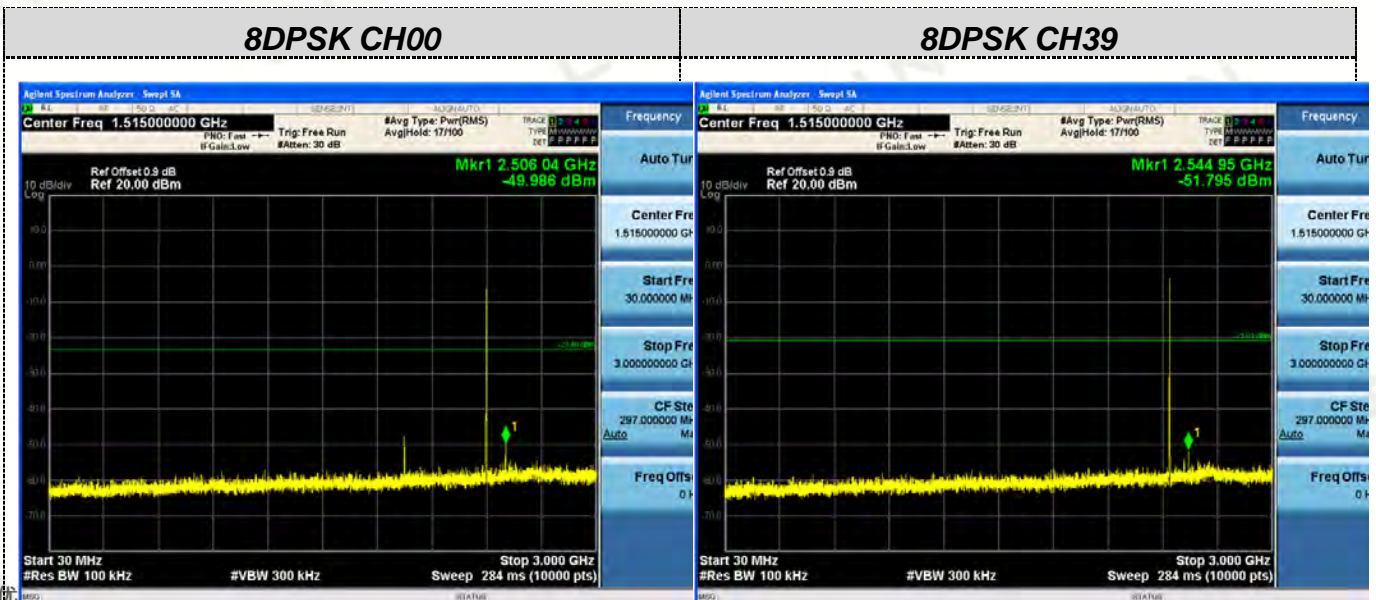

30MHz-3GHz



30MHz-3GHz

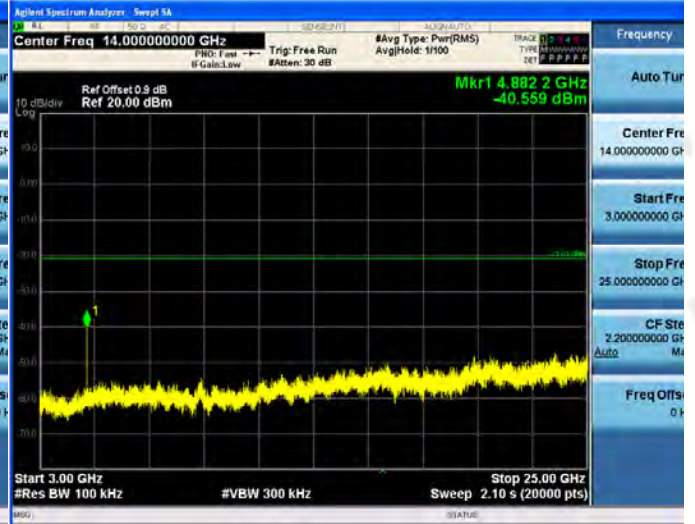

3GHz-25GHz

3GHz-25GHz

8DPSK CH78

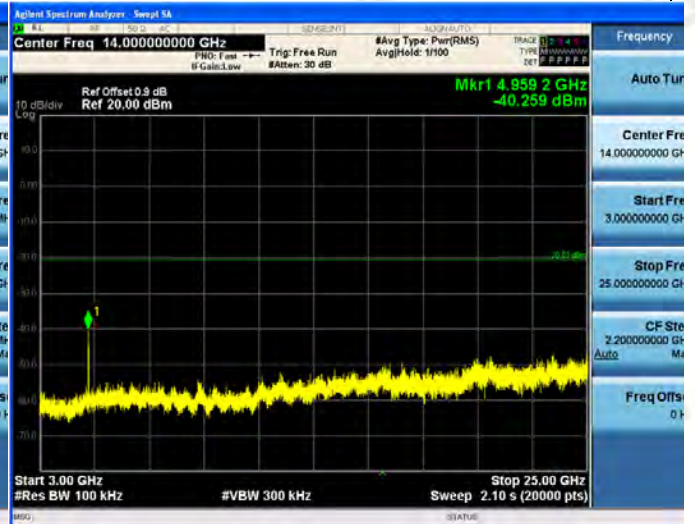
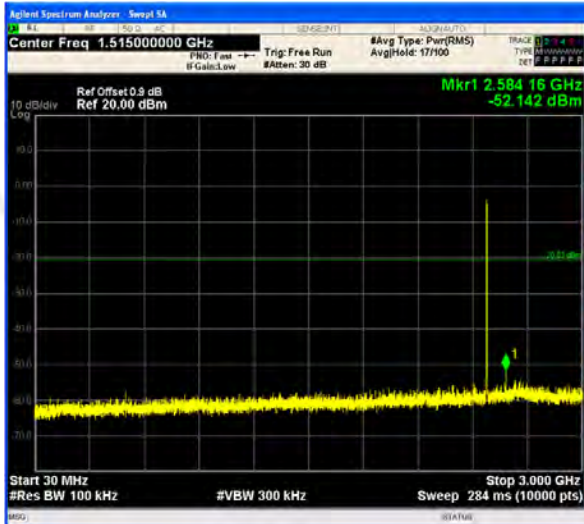

30MHz-3GHz

3GHz-25GHz

**GFSK**

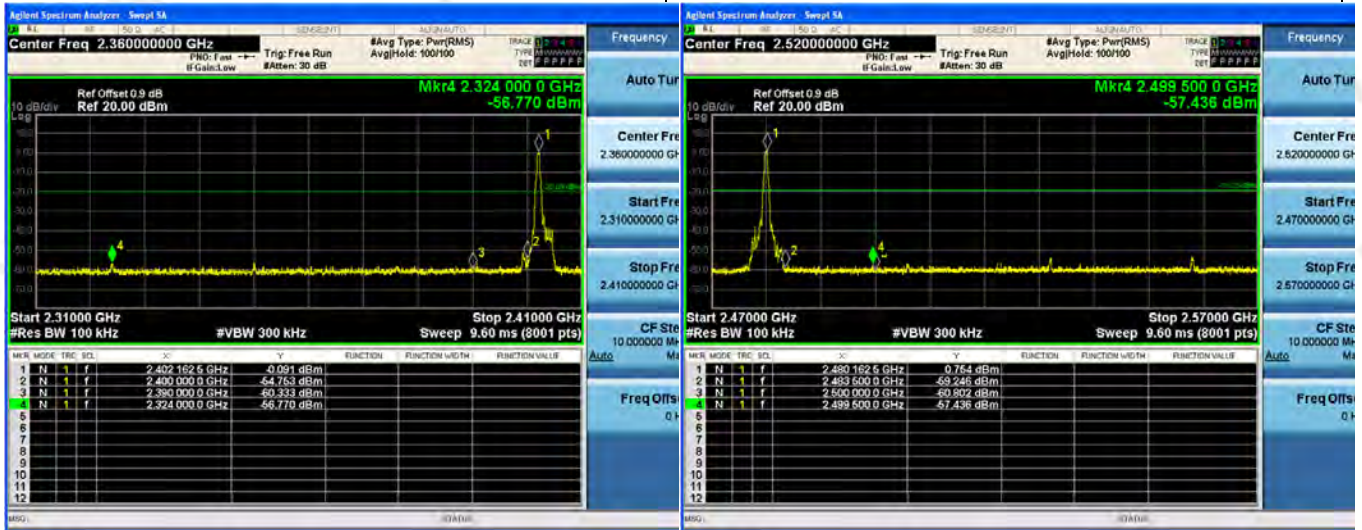

Left Band edge hopping off

Right Band edge hopping off

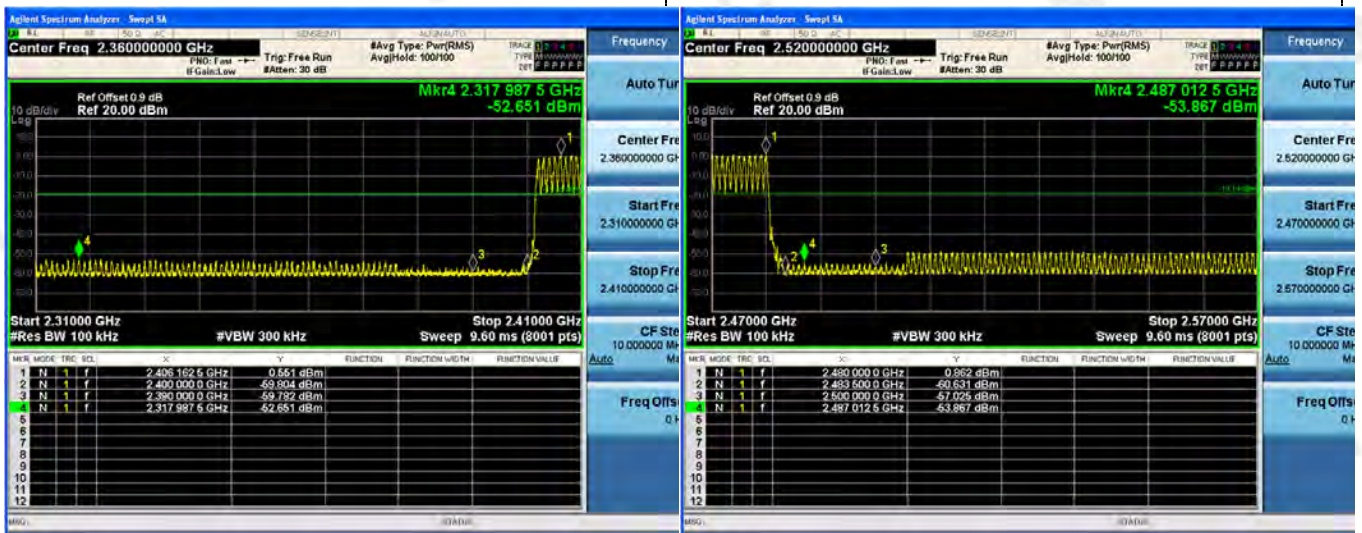

Left Band edge hopping on

Right Band edge hopping on



$\pi$  /4DQPSK

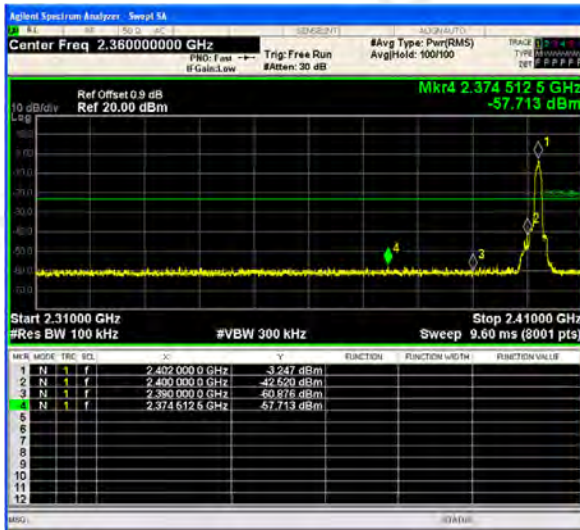

Left Band edge hopping off

Right Band edge hopping off

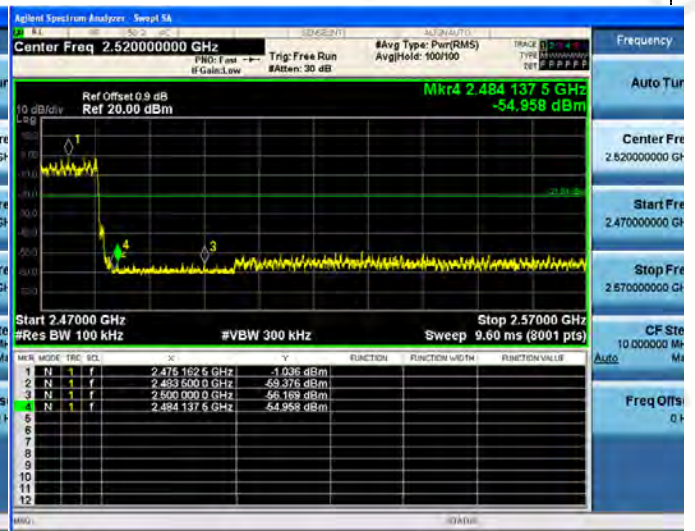
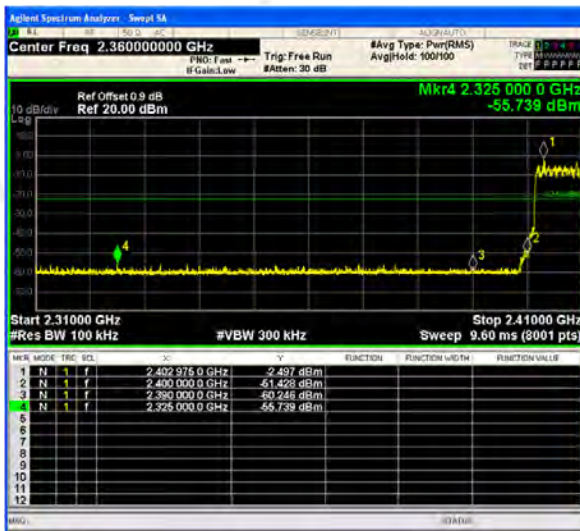

Left Band edge hopping on

Right Band edge hopping on

### 8DPSK

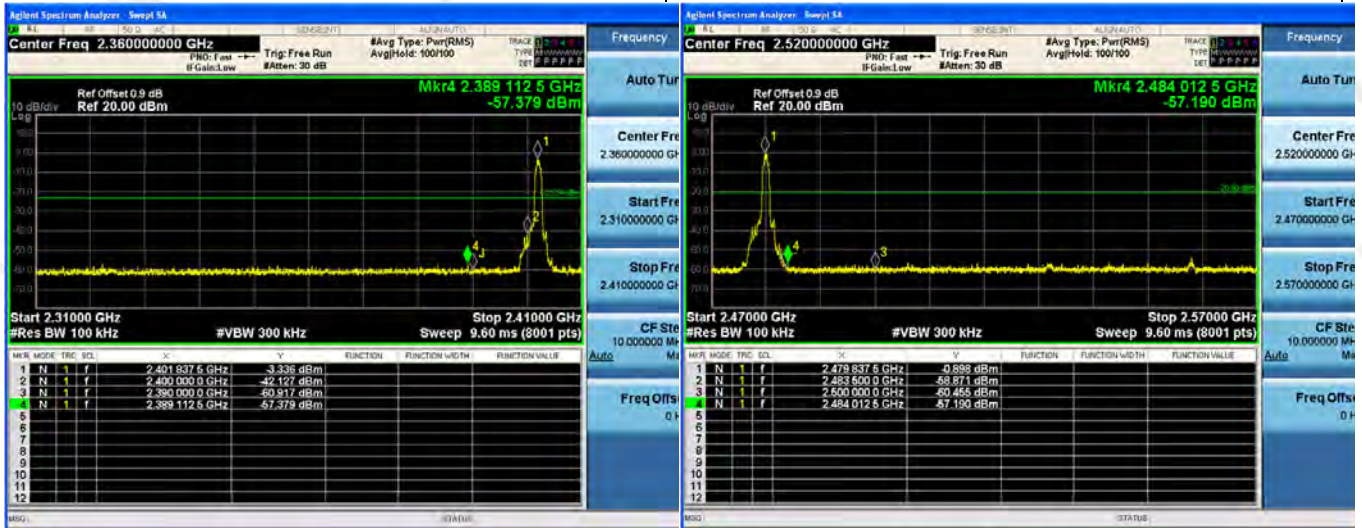

Left Band edge hopping off

Right Band edge hopping off

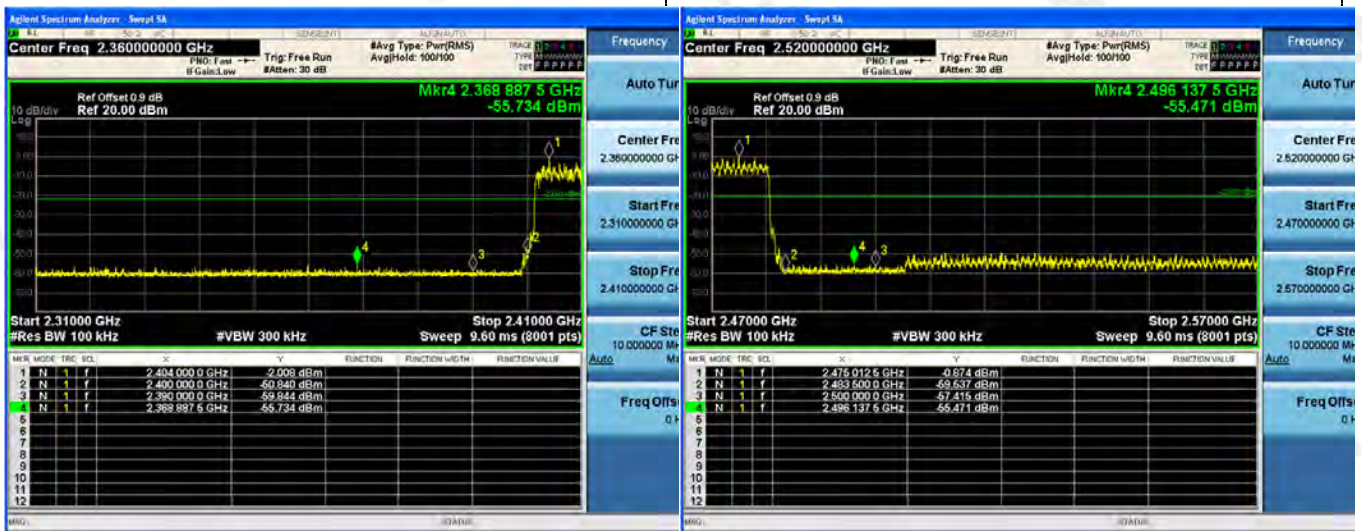

Left Band edge hopping on

Right Band edge hopping on

### 3.10 Pseudorandom Frequency Hopping Sequence

#### TEST APPLICABLE

#### For 47 CFR Part 15C section 15.247 (g) (h) requirement:

Frequency hopping systems shall have hopping channel carrier frequencies separated by a minimum of 25 kHz or the 20 dB bandwidth of the hop-ping channel, whichever is greater. Alternatively, frequency hopping systems operating in the 2400–2483.5 MHz band may have hopping channel carrier frequencies that are separated by 25 kHz or two-thirds of the 20 dB bandwidth of the hopping channel, whichever is greater, provided the systems operate with an output power no greater than 125 mW. The system shall hop to channel frequencies that are selected at the system hopping rate from a pseudo randomly ordered list of hopping frequencies. Each frequency must be used equally on the average by each transmitter. The system receivers shall have input bandwidths that match the hop-ping channel bandwidths of their corresponding transmitters and shall shift frequencies in synchronization with the transmitted signals.

#### EUT Pseudorandom Frequency Hopping Sequence Requirement

The pseudorandom frequency hopping sequence may be generated in a nine-stage shift register whose 5<sup>th</sup> and 9<sup>th</sup> stage outputs are added in a modulo-two addition stage. And the result is fed back to the input of the first stage. The sequence begins with the first one of 9 consecutive ones, for example: the shift register is initialized with nine ones.

- Number of shift register stages:9
- Length of pseudo-random sequence:29-1=511 bits
- Longest sequence of zeros:8(non-inverted signal)

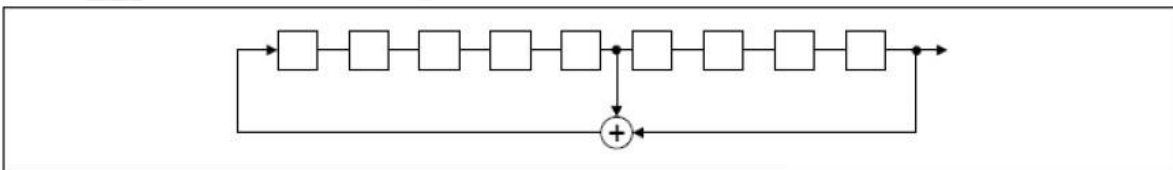

*Linear Feedback Shift Register for Generation of the PRBS sequence*

An example of pseudorandom frequency hopping sequence as follows:

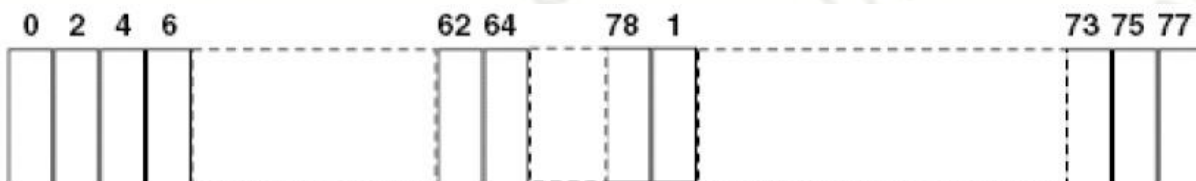

Each frequency used equally on the average by each transmitter.

According to Bluetooth Core Specification, Bluetooth receivers are designed to have input and IF bandwidths that match the hopping channel bandwidths of any Bluetooth transmitters and shift frequencies in synchronization with the transmitted signals.

<p>Compliance for section 15.247(g)</p> <p>According to Bluetooth Core Specification, the Bluetooth system transmits the packet with the pseudorandom hopping frequency with a continuous data and the short burst transmission from the Bluetooth system is also transmitted under the frequency hopping system with the pseudorandom hopping frequency system.</p>
<p>Compliance for section 15.247(h)</p> <p>According to Bluetooth Core specification, the Bluetooth system incorporates with an adaptive system to detect other user within the spectrum band so that it individually and independently to avoid hopping on the occupied channels.</p> <p>According to the Bluetooth Core specification, the Bluetooth system is designed not have the ability to coordinated with other FHSS System in an effort to avoid the simultaneous occupancy of individual hopping frequencies by multiple transmitter.</p>

### 3.11 ANTENNA REQUIREMENT

Standard Applicable:

For intentional device, according to FCC 47 CFR Section 15.203, an intentional radiator shall be designed to ensure that no antenna other than that furnished by the responsible party shall be used with the device.

Antenna Connected Construction

The antenna used in this product is an Integral Antenna, the directional gains of antenna used for transmitting is 0.0dbi.

ANTENNA

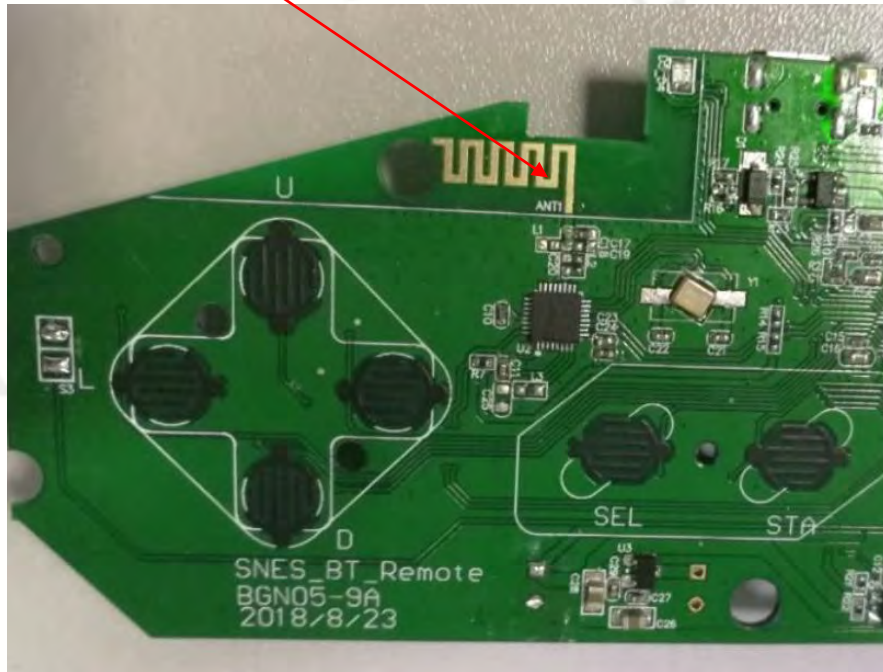

#### 4 PHOTOGRAPH OF TEST



### 5 PHOTOGRAPH OF EUT

#### External photos



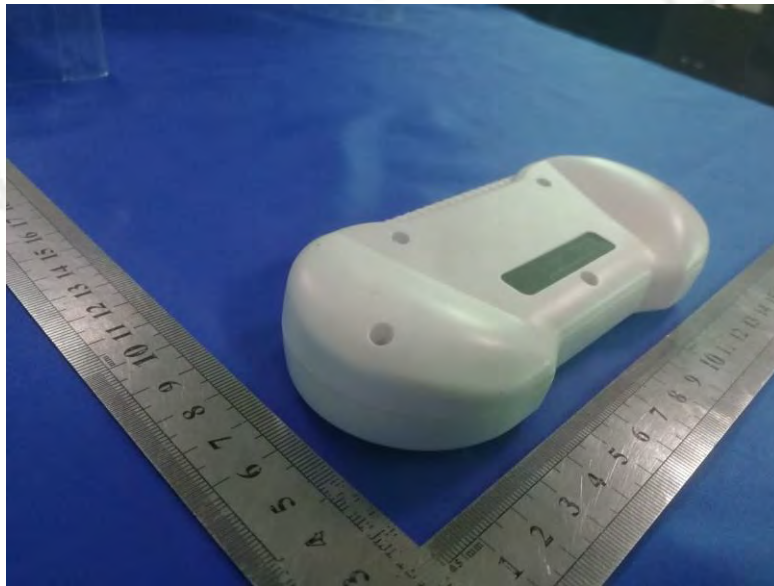



**Internal Photos**

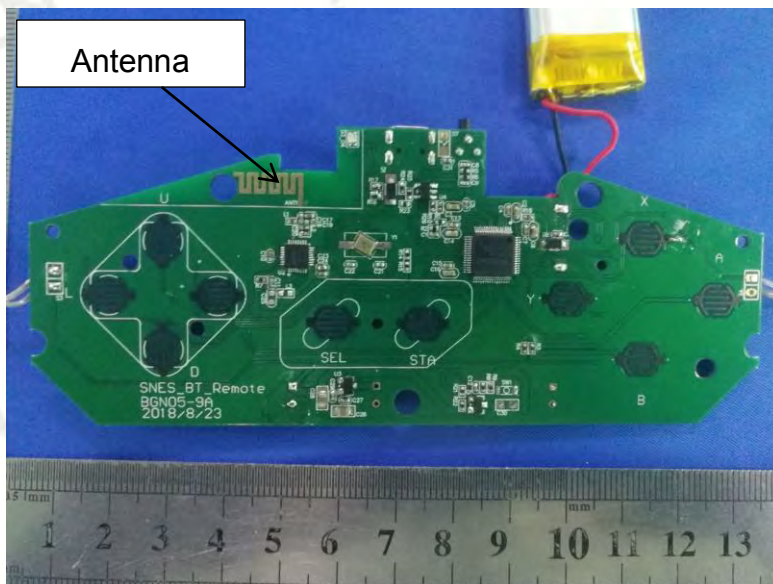
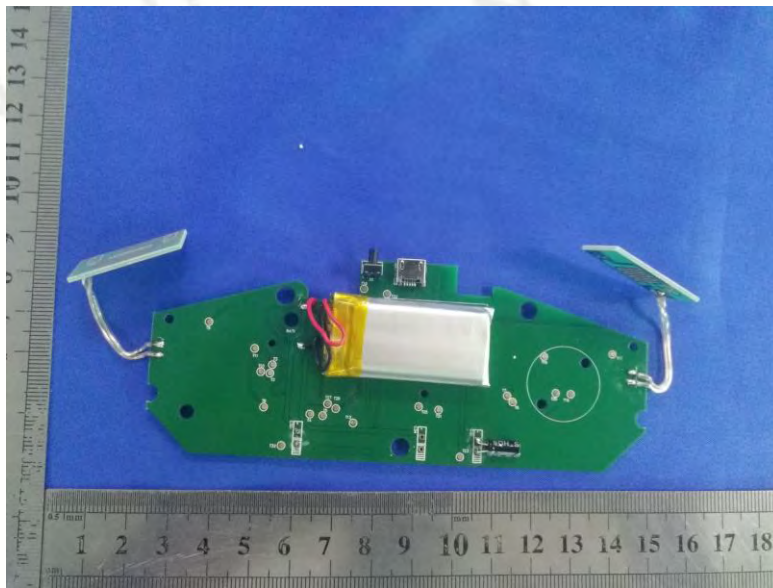
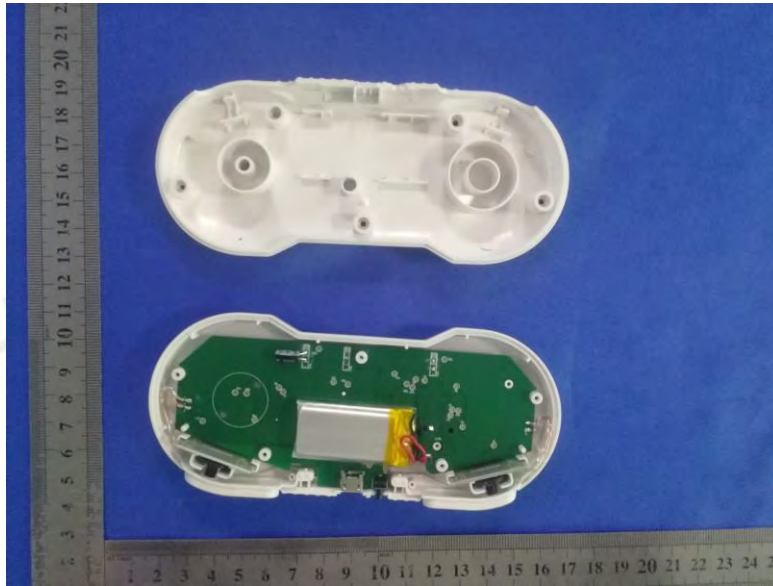

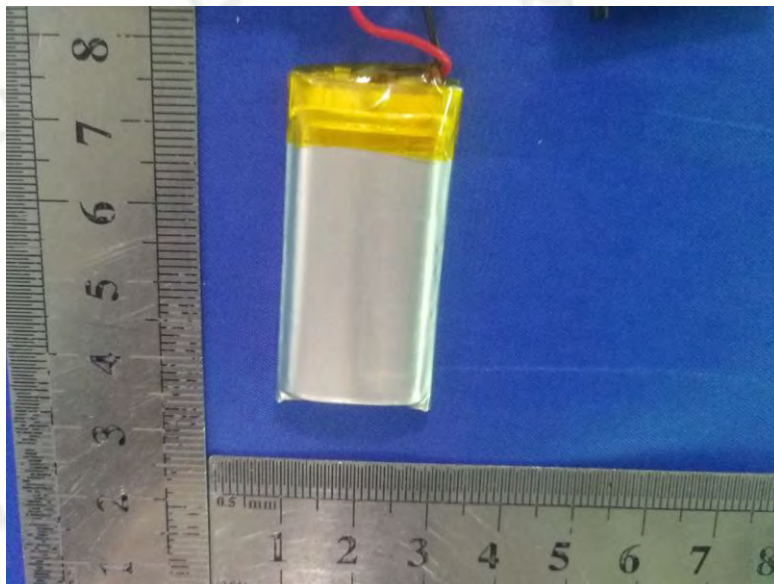
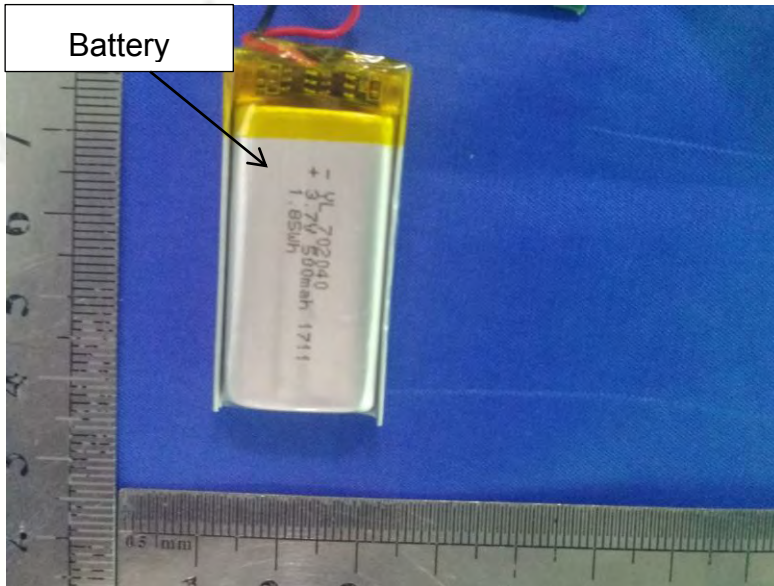
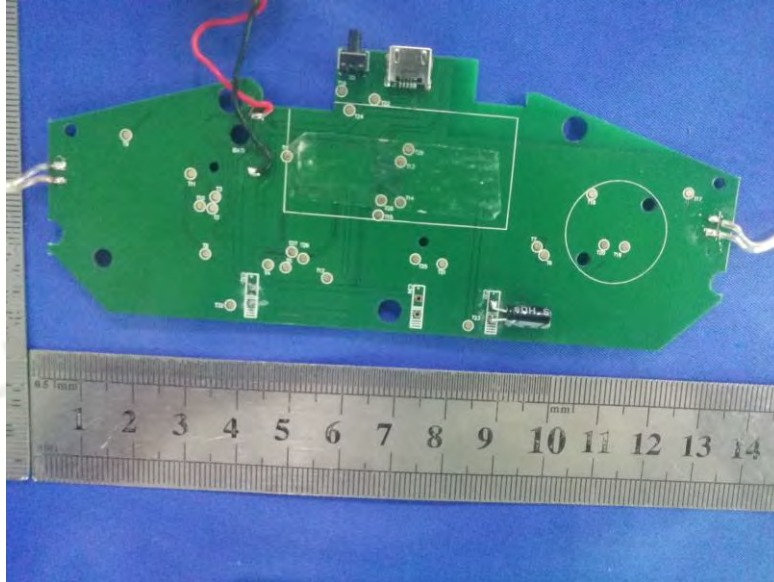

\*\*\*\*\* End of Report \*\*\*\*\*