

# FCC PART 15.236 Measurement and Test Report

For

Shenzhen Jiayz photo industrial ., Ltd

**FCC ID:2ARN3-BY-WM8PRO**

<b>FCC Rule(s):</b>	<u>FCC PART 15.236</u>
<b>Product Description:</b>	<u>UHF Dual-Channel Wireless Microphone System</u>
<b>Tested Model:</b>	<u>BY-WM8 pro</u>
<b>Report No.:</b>	<u>BSL11888702RF</u>
<b>Tested Date:</b>	<u>October 14-15, 2018</u>
<b>Issued Date:</b>	<u>October 20, 2018</u>
<b>Tested By:</b>	<u>Lisa. Li / Engineer</u> <i>Lisa. Ji</i>
<b>Reviewed By:</b>	<u>Messi Wang / EMC Manager</u> <i>Messi Wang</i>
<b>Approved &amp; Authorized By:</b>	<u>Mike mo / PSQ Manager</u> <i>Mike mo</i>
<b>Prepared By:</b>	

**BSL Testing Co.,LTD.**  
NO. 24, ZH Park, Nantou, Shenzhen, 518000 China  
Tel: 400-882-9628 Fax: 86- 755-26508703

**TABLE OF CONTENTS**

<b>1. GENERAL INFORMATION.....</b>	<b>3</b>
1.1 PRODUCT DESCRIPTION FOR EQUIPMENT UNDER TEST (EUT).....	3
1.2 TEST STANDARDS.....	4
1.3 TEST METHODOLOGY.....	4
1.4 TEST FACILITY.....	4
1.5 EUT SETUP AND TEST MODE.....	5
1.6 MEASUREMENT UNCERTAINTY.....	5
1.7 TEST EQUIPMENT LIST AND DETAILS.....	6
<b>2. SUMMARY OF TEST RESULTS.....</b>	<b>7</b>
<b>3. RF EXPOSURE.....</b>	<b>8</b>
3.1 STANDARD APPLICABLE.....	8
3.2 TEST RESULT.....	8
<b>4. ANTENNA REQUIREMENT.....</b>	<b>9</b>
4.1 STANDARD APPLICABLE.....	9
4.2 EVALUATION INFORMATION.....	9
<b>5. RF OUTPUT POWER.....</b>	<b>10</b>
5.1 STANDARD APPLICABLE.....	10
5.2 TEST PROCEDURE.....	10
5.3 ENVIRONMENTAL CONDITIONS.....	10
5.4 SUMMARY OF TEST RESULTS/PLOTS.....	10
<b>6. OCCUPIED BANDWIDTH.....</b>	<b>15</b>
6.1 STANDARD APPLICABLE.....	15
6.2 TEST PROCEDURE.....	15
6.3 ENVIRONMENTAL CONDITIONS.....	15
6.4 SUMMARY OF TEST RESULTS/PLOTS.....	15
<b>7. FREQUENCY STABILITY.....</b>	<b>19</b>
7.1 STANDARD APPLICABLE.....	19
7.2 TEST PROCEDURE.....	19
7.3 ENVIRONMENTAL CONDITIONS.....	19
7.4 SUMMARY OF TEST RESULTS/PLOTS.....	19
<b>8. TRANSMITTER SPURIOUS EMISSIONS &amp; EMISSION MASK.....</b>	<b>22</b>
8.1 STANDARD APPLICABLE.....	22
8.2 TEST PROCEDURE.....	22
8.4 ENVIRONMENTAL CONDITIONS.....	25
8.5 SUMMARY OF TEST RESULTS/PLOTS.....	26
<b>10. CONDUCTED EMISSIONS.....</b>	<b>31</b>
10.1 TEST PROCEDURE.....	31
10.2 BASIC TEST SETUP BLOCK DIAGRAM.....	31
10.3 ENVIRONMENTAL CONDITIONS.....	31
10.4 TEST RECEIVER SETUP.....	32
10.5 SUMMARY OF TEST RESULTS/PLOTS.....	32
10.6 CONDUCTED EMISSIONS TEST DATA.....	32

## 1. GENERAL INFORMATION

---

### 1.1 Product Description for Equipment Under Test (EUT)

#### Client Information

Applicant: Shenzhen Jiayz photo industrial ., Ltd  
 Address of applicant: A16 Building,Intelligent Terminal Industrial Park of Sililcon Valley Power, Guanlan, Longhua District, Shenzhen, China

Manufacturer: Shenzhen Jiayz photo industrial ., Ltd  
 Address of manufacturer: A16 Building,Intelligent Terminal Industrial Park of Sililcon Valley Power, Guanlan, Longhua District, Shenzhen, China

General Description of EUT	
Product Name:	UHF Dual-Channel Wireless Microphone System
Brand Name:	 <b>BOYA</b> <sup>®</sup>
Model No.:	BY-WM8 pro,BY-WHM8 pro,BY-WXLR8 pro,SP-RX8 pro, RX-XLR8 pro
Rated Voltage:	DC 3V from battery
<i>Note: The test data is gathered from a production sample provided by the manufacturer.</i>	

Technical Characteristics of EUT	
Frequency Range:	Transmit A:556.710~575.980MHz Transmit B:576.390~595.660MHz
RF Output Power:	Transmit A:6.93dBm (Conducted) Transmit B:6.92dBm (Conducted)
Modulation:	FSK
Quantity of Channels:	Transmit A:48 Transmit B:48
Type of Antenna:	Rod
Antenna Gain:	0dBi

## 1.2 Test Standards

The following report is prepared on behalf of the Shenzhen Jiayz photo industrial ., Ltd in accordance with FCC Part 15, Subpart C, and section 15.203, 15.209 and 15.236 of the Federal Communication Commissions rules.

The objective is to determine compliance with FCC Part 15, Subpart C, and section 15.203, 15.209 and 15.236 of the Federal Communication Commissions rules.

**Maintenance of compliance** is the responsibility of the manufacturer. Any modification of the product, which result in lowering the emission, should be checked to ensure compliance has been maintained.

## 1.3 Test Methodology

Both AC mains line-conducted and radiated emission measurements were performed according to the procedures in ANSI C63.10 (2013) & ETSI EN 300422-1 V1.4.2(2011-08). Radiated emission measurement was performed in semi-anechoic chamber and conducted emission measurement was performed in shield room. For radiated emission measurement, preliminary scans were performed in the semi-anechoic chamber only to determine the worst case modes. All radiated tests were performed at an antenna to EUT distance of 3 meters. All other measurements were made in accordance with the procedures in 47 CFR part 2.

## 1.4 Test Facility

BSL Testing Co.,LTD.

NO. 24, ZH Park, Nantou, Shenzhen, 518000 China

Designation Number : CN1217

Test Firm Registration Number: 866035

Tel: 86- 755-26508703

Fax: 86- 755-26508703

### 1.5 EUT Setup and Test Mode

The EUT was operated in the engineering mode to fix the Tx frequency that was for the purpose of the measurements. All testing shall be performed under maximum output power condition, and to measure its highest possible emissions level, more detailed description as follows:

Test Mode List		
Test Mode	Description	Remark
TM1	Transmit A	556.710MHz,566.140MHz,575.980MHz
TM2	Transmit B	576.390MHz,585.820MHz,595.660MHz

EUT Cable List and Details			
Cable Description	Length (m)	Shielded/Unshielded	With / Without Ferrite
/	/	/	/

Special Cable List and Details			
Cable Description	Length (m)	Shielded/Unshielded	With / Without Ferrite
/	/	/	/

Auxiliary Equipment List and Details			
Description	Manufacturer	Model	Serial Number

### 1.6 Measurement Uncertainty

Measurement uncertainty		
Parameter	Conditions	Uncertainty
RF Output Power	Conducted	$\pm 0.42\text{dB}$
Occupied Bandwidth	Conducted	$\pm 1.5\%$
Power Spectral Density	Conducted	$\pm 1.8\text{dB}$
Conducted Spurious Emission	Conducted	$\pm 2.17\text{dB}$
Conducted Emissions	Conducted	$\pm 2.88\text{dB}$
Transmitter Spurious Emissions	Radiated	$\pm 5.1\text{dB}$

**1.7 Test Equipment List and Details**

Description	Manufacturer	Model	Serial No.	Cal Date	Due. Date
Communication Tester	Rohde & Schwarz	CMW500	100358	2017-10-21	2018-10-20
Spectrum Analyzer	R&S	FSP40	100550	2017-10-21	2018-10-20
Test Receiver	R&S	ESCI7	US47140102	2017-10-21	2018-10-20
Signal Generator	HP	83630B	3844A01028	2017-10-22	2018-10-21
Test Receiver	R&S	ESPI-3	100180	2017-10-21	2018-10-20
Amplifier	Agilent	8449B	4035A00116	2017-10-22	2018-10-21
Amplifier	HP	8447E	2945A02770	2017-10-22	2018-10-21
Signal Generator	IFR	2023A	202307/242	2017-10-22	2018-10-21
Broadband Antenna	SCHAFFNER	2774	2774	2017-10-17	2018-10-16
Biconical and log periodic antennas	ELECTRO-METRI CS	EM-6917B-1	171	2017-10-17	2018-10-16
Horn Antenna	R&S	HF906	100253	2017-10-17	2018-10-16
Horn Antenna	EM	EM-6961	6462	2017-10-17	2018-10-16
LISN	R&S	ESH3-Z5	100196	2017-10-17	2018-10-16
LISN	COM-POWER	LI-115	02027	2017-10-17	2018-10-16
3m Semi-Anechoic Chamber	Chengyu Electron	9 (L)*6 (W)* 6 (H)	BSL086	2017-10-21	2018-10-20
Horn Antenna	A-INFOMW	LB-180400KF	BSL088	2017-10-21	2018-10-20

**2. SUMMARY OF TEST RESULTS**

---

<b>FCC Rules</b>	<b>Description of Test Item</b>	<b>Result</b>
§ 2.1093	RF Exposure	PASS
§ 15.203	Antenna Requirement	PASS
§ 15.207(a)	Conducted Emission	N/A
§ 15.236(d)	RF Output Power	PASS
§ 15.236(f)	Occupied Bandwidth	PASS
§ 15.236(f)(3)	Frequency stability	PASS
§ 15.236(g)	Transmitter Spurious Emissions & Emission mask	PASS

Note:

1. PASS: applicable, N/A: not applicable.
2. this EUT is powered by battery only, the AC Power Conducted Emission is not applicable.

### **3. RF Exposure**

---

#### **3.1 Standard Applicable**

According to § 1.1307 and § 2.1093, the portable transmitter must comply the RF exposure requirements.

#### **3.2 Test Result**

This product complied with the requirement of the RF exposure, please see the RF Exposure Report.



## **4. Antenna Requirement**

---

### **4.1 Standard Applicable**

According to FCC Part 15.203, an intentional radiator shall be designed to ensure that no antenna other than that furnished by the responsible party shall be used with the device. The use of a permanently attached antenna or of an antenna that uses a unique coupling to the intentional radiator shall be considered sufficient to comply with the provisions of this section.

### **4.2 Evaluation Information**

This product has a Rod antenna, fulfill the requirement of this section.

## 5. RF Output Power

---

### 5.1 Standard Applicable

Maximum Conducted Output power at Antenna Terminals, FCC Rules 15.236(d):

- (1) In the bands allocated and assigned for broadcast television and in the 600MHz service band: 50mW EIRP.
- (2) In the 600MHz guard bands including the duplex gap: 20mW EIRP.

### 5.2 Test Procedure

1. The maximum peak output power was measured with a Spectrum analyzer connected to antenna terminal while EUT was operating in unmodulated situation.
2. Power was supplied to the battery input connector a power supply. The power supply was set for +3.0VDC. The spectrum analyzer was connected at antenna terminal to measure RF Power of carrier.
3. A Multimeter was connected in series with final RF stage to measure the current; A multimeter was used to measure final RF stage supply voltage. Then the voltage v.s. current of the final RF stage can be showed.

### 5.3 Environmental Conditions

Temperature:	26° C
Relative Humidity:	54%
ATM Pressure:	1011 mbar

### 5.4 Summary of Test Results/Plots

Transmit A

Frequency MHz	Peak Output Power dBm	Limit dBm
556.710	6.67	17
566.140	6.93	17
575.980	6.75	17

Transmit B

Frequency MHz	Peak Output Power dBm	Limit dBm
576.390	6.92	17
585.820	6.88	17
595.660	6.67	17

Test Result: PASS

Please refer to the following test plots:

Transmit A

556.710MHz

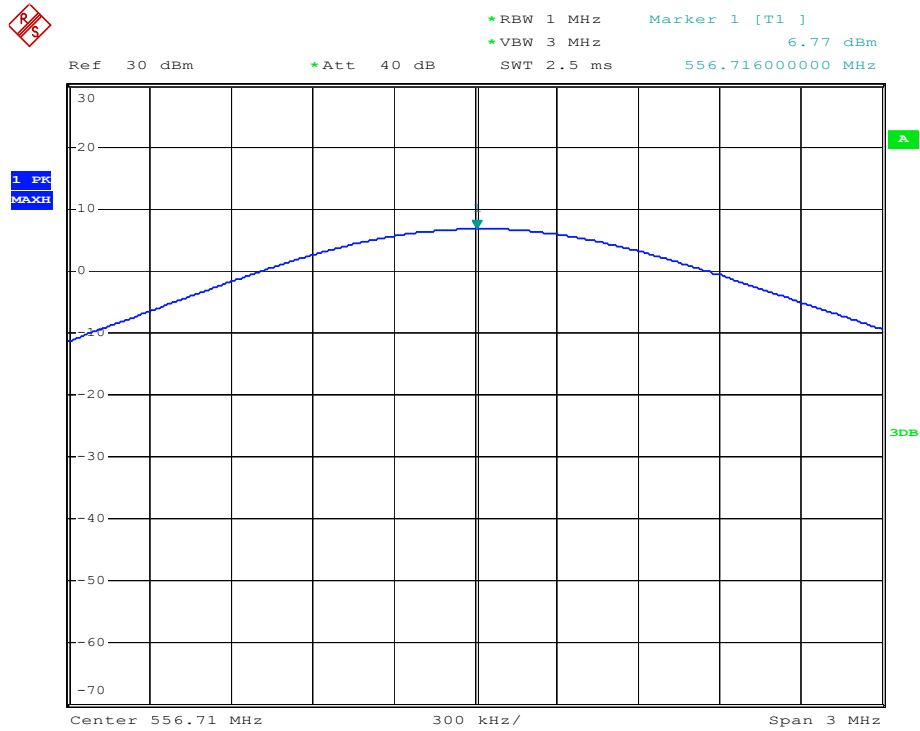

566.140MHz

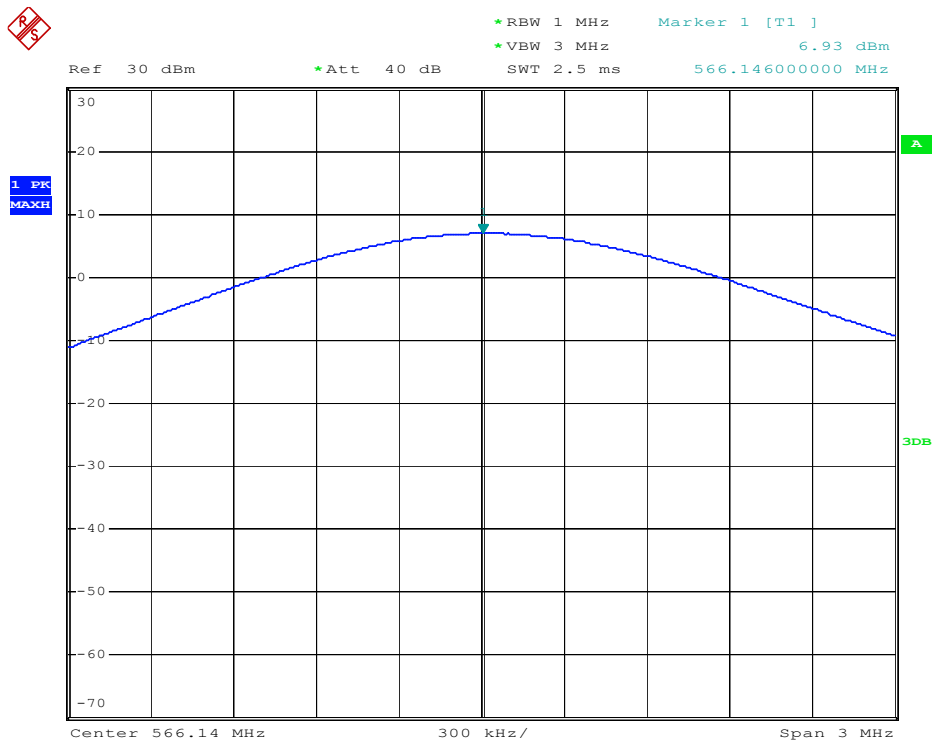

575.980MHz

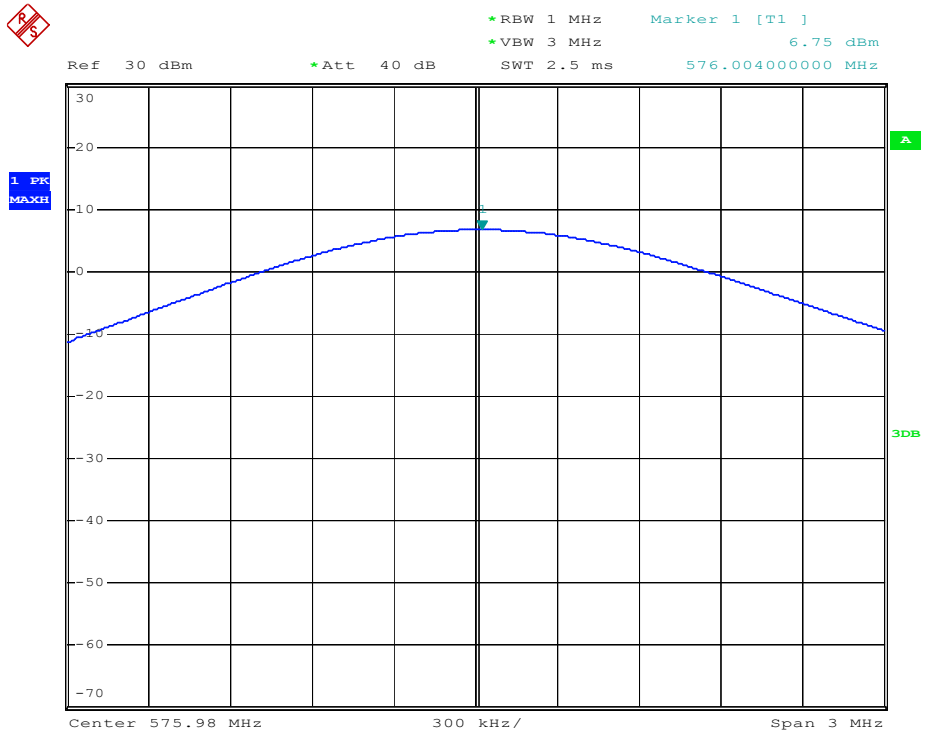

Transmit B

576.390MHz

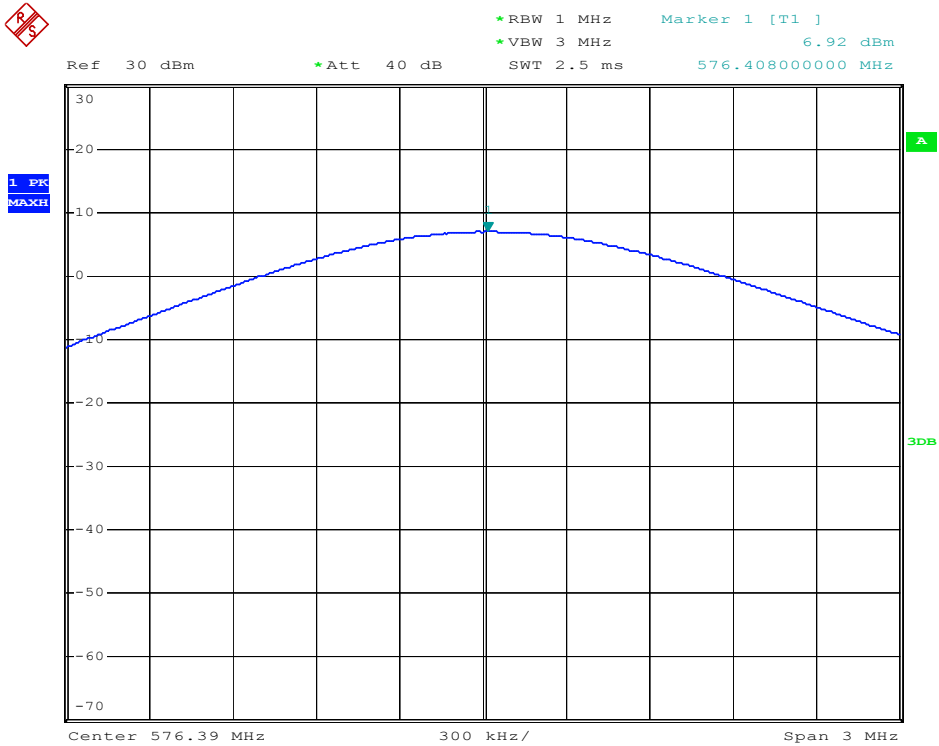

585.820MHz

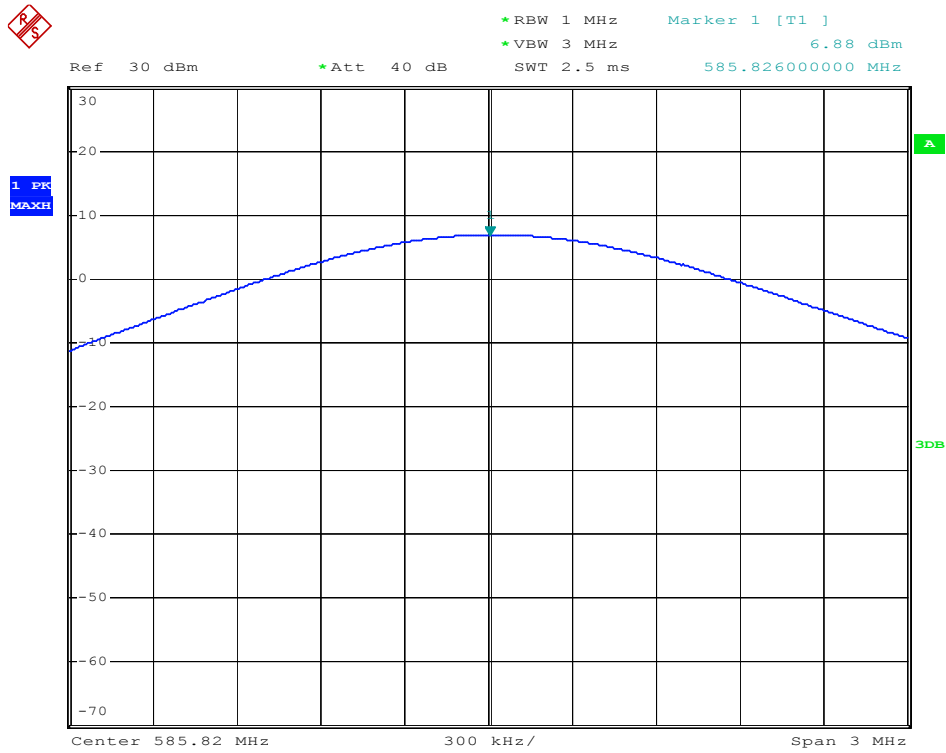

595.660MHz

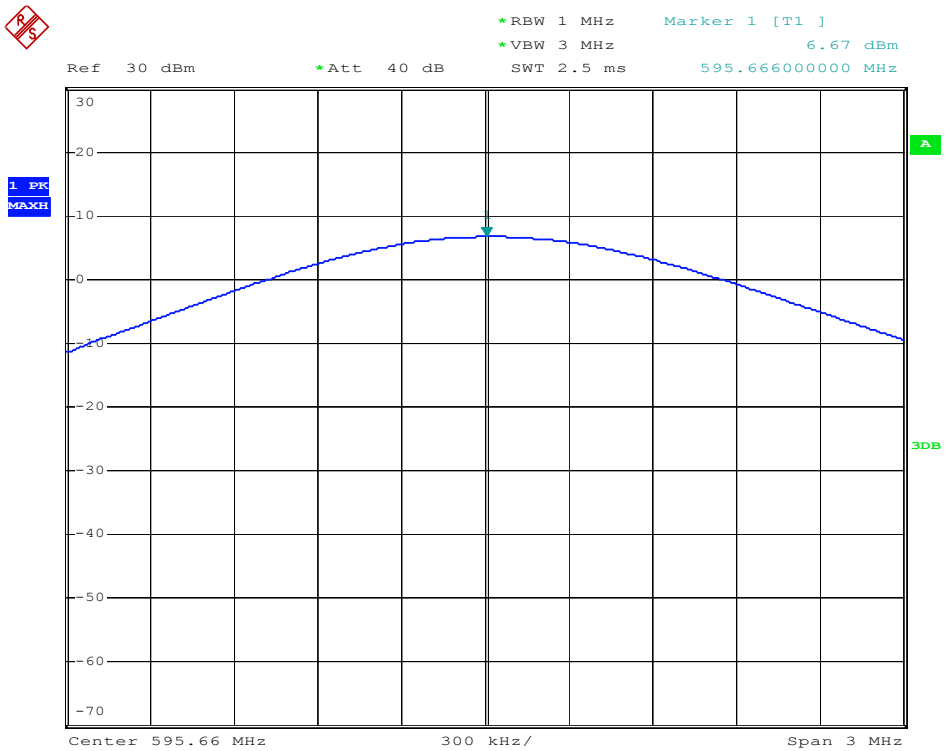

## 6. Occupied Bandwidth

---

### 6.1 Standard Applicable

FCC15.236 (f) The operating bandwidth shall not exceed 200 kHz.

### 6.2 Test Procedure

According to FCC 15.236(f), The operating frequency within a permissible band of operation as defined in paragraph (c) must comply with the following requirements.

(1) The frequency selection shall be offset from the upper or lower band limits by 25KHz or an integral multiple thereof.

(2) One or more adjacent 25KHz segments within the assignable frequencies may be combined to form a channel whose maximum bandwidth shall not exceed 200KHz. The operating bandwidth shall not exceed 200KHz.

According the ANSI C6.10-2013 section 6.9 for additional test set-up procedure, the occupied bandwidth of emission was measured with a spectrum analyzer connected to the antenna terminal while EUT was operating in 2.5KHz tone at an input level 16dB grater than necessary to produce 50 percent modulation. Then mark the -26dB Bandwidth and reord it.

### 6.3 Environmental Conditions

Temperature:	25° C
Relative Humidity:	53%
ATM Pressure:	1018 mbar

### 6.4 Summary of Test Results/Plots

#### Transmit A

Frequency(MHz)	99% Bandwidth(kHz)	-26dB Bandwidth(kHz)	Limit
556.710	182	196	<200KHz
566.140	182	194	<200KHz
575.980	182	194	<200KHz

#### Transmit B

Frequency(MHz)	99% Bandwidth (kHz)	-26dB Bandwidth(kHz)	Limit
576.390	182	194	<200KHz
585.820	182	196	<200KHz
595.660	182	192	<200KHz

Transmit A

556.710MHz

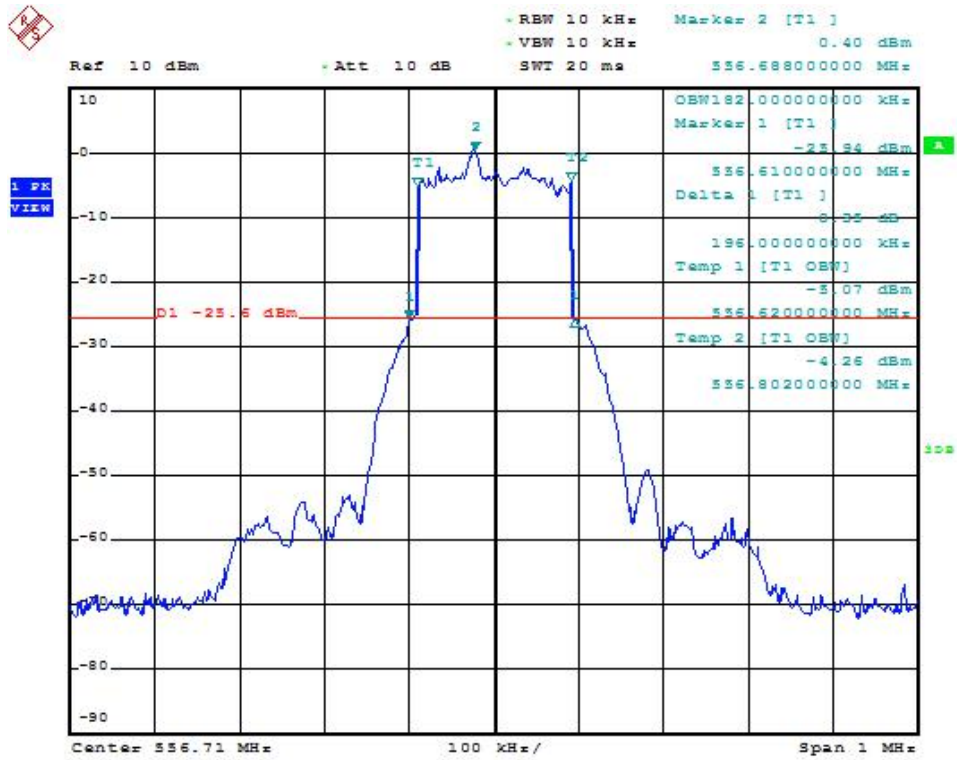

566.140MHz

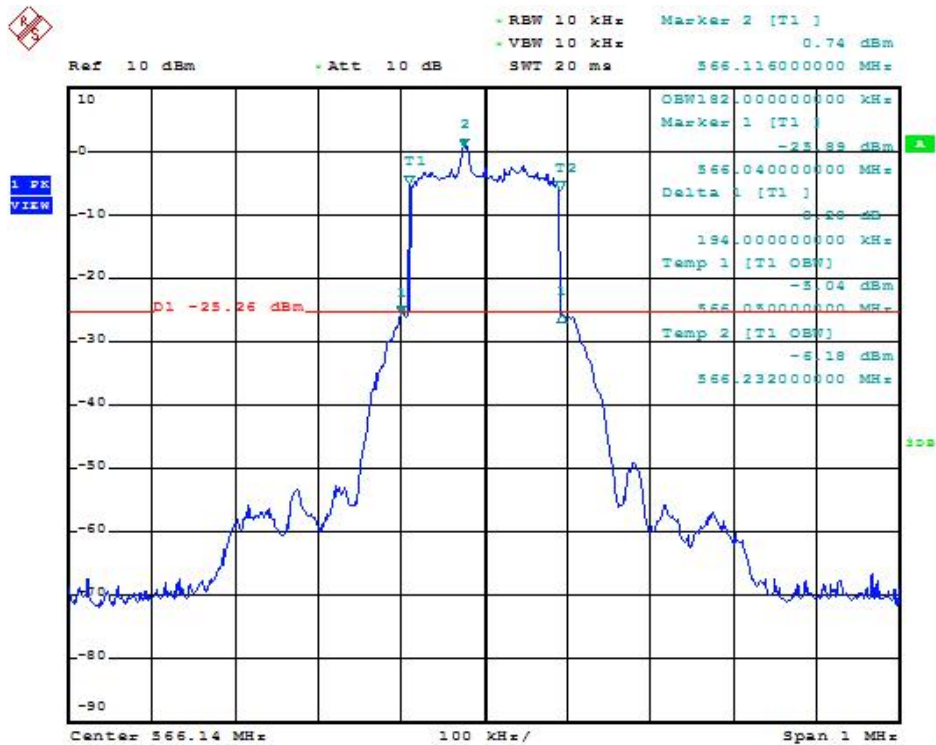



### 575.980MHz

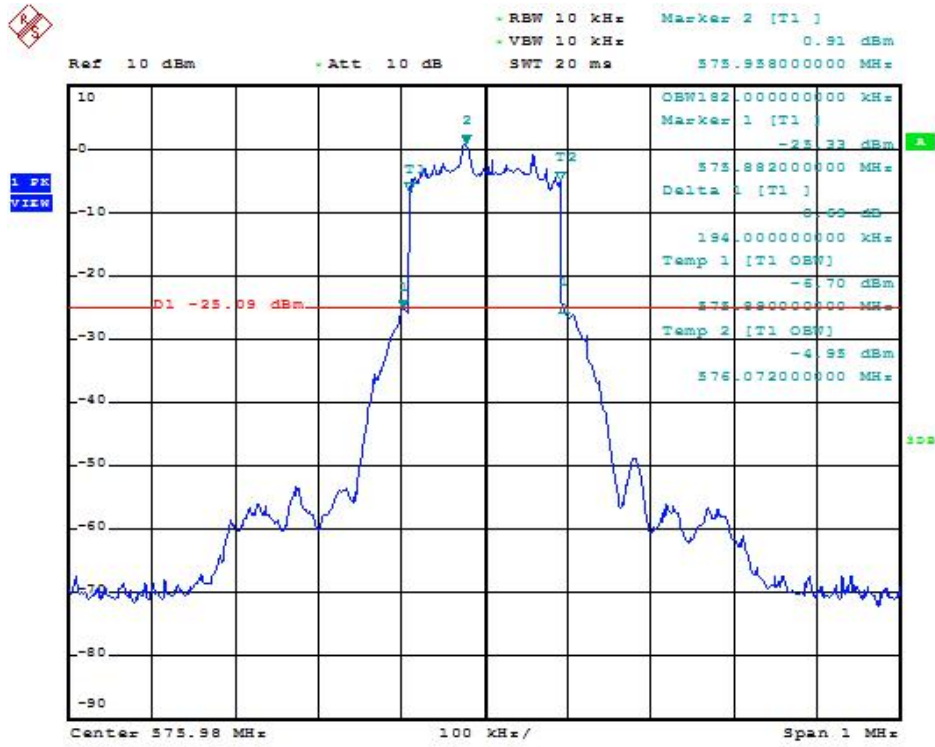

### Transmit B

### 576.390MHz

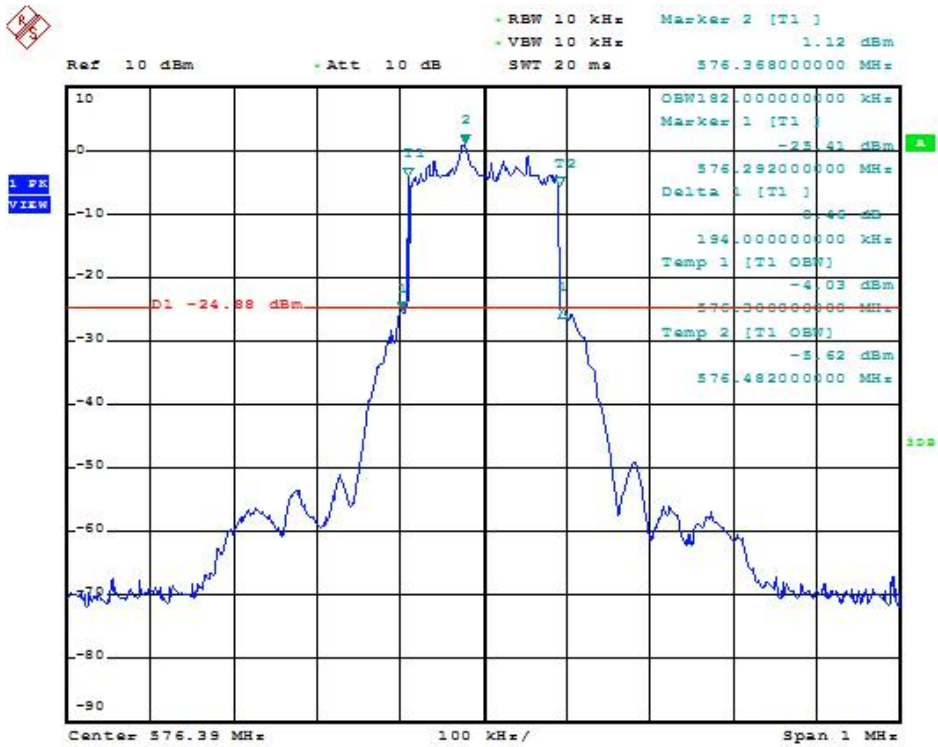

585.820MHz

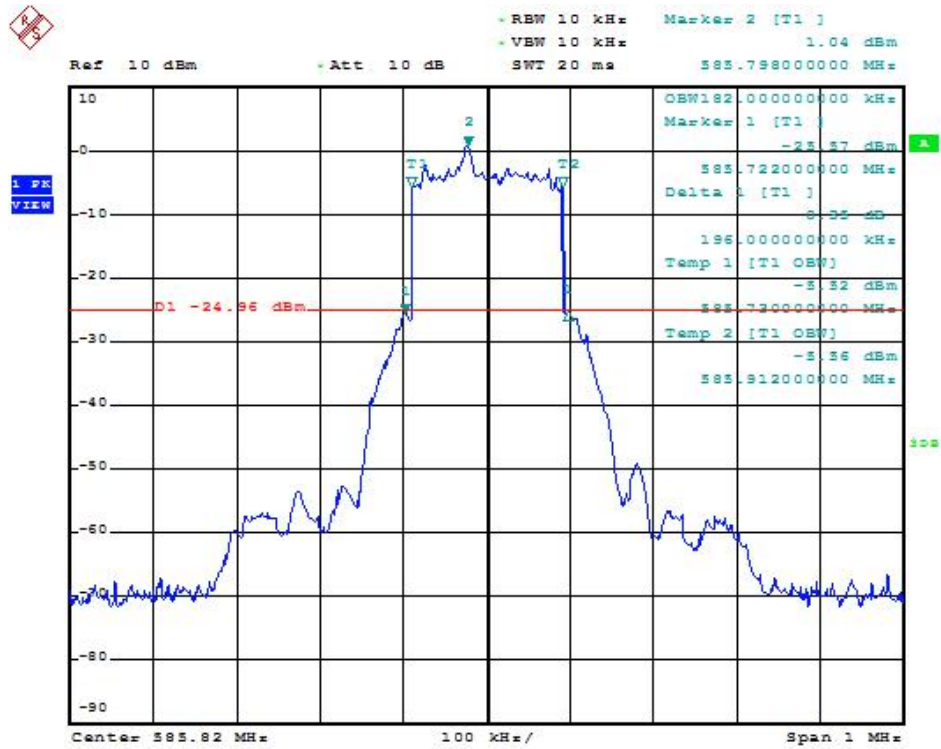

595.660MHz

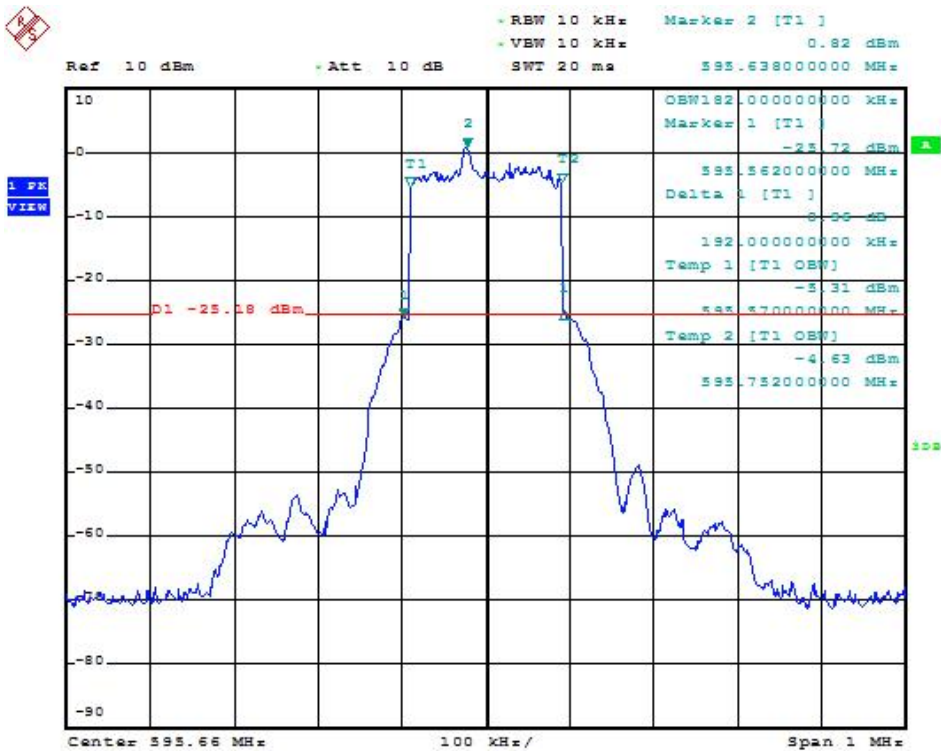

Test Result: PASS

## 7. Frequency stability

---

### 7.1 Standard Applicable

According to 15.236(f)(3). The frequency tolerance of the transmitter shall be 0.005 percent.

### 7.2 Test Procedure

According to FCC 15.236(f)(3), The frequency tolerance of the carrier signal shall be maintained within 0.005% of the operating frequency over a temperature variation of -20 degrees to +50 degrees C at normal supply voltage, and for a variation in the primary supply voltage from 85% to 115% of the rated supply voltage at a temperature of 20 degrees C. Battery operated equipment shall be tested using a new battery.

1. Setup the configuration of the ambient temperature from -20 degrees to 50 degrees with sufficient time. And measure the different power of the EUT with an artificial power from highest to end point voltage.
2. Set frequency counter center frequency to the right frequency needs to be measured.

### 7.3 Environmental Conditions

Temperature:	26° C
Relative Humidity:	57%
ATM Pressure:	1011 mbar

### 7.4 Summary of Test Results/Plots

Transmit A

Test conditions		Frequency Error
Temperature(°C)	Voltage(V)	556.7100MHz
25	3.0	556.7207
	2.55	556.7215
	3.45	556.7159
-20	3.0	556.7261
	2.55	556.7318
	3.45	556.7295
55	3.0	556.7252
	2.55	556.7309
	3.45	556.7286
Max. frequency error (ppm)		39.1
Limit(ppm)		±50ppm

Test conditions		Frequency Error
Temperature(°C)	Voltage(V)	566.1400MHz
25	3.0	566.1521
	2.55	566.1604
	3.45	566.1514
-20	3.0	566.1522
	2.55	566.1548
	3.45	566.1498
55	3.0	566.1512
	2.55	566.1534
	3.45	566.1535
Max. frequency error (ppm)		36.0
Limit(ppm)		±50ppm

Test conditions		Frequency Error
Temperature(°C)	Voltage(V)	575.9800MHz
25	3.0	575.9665
	2.55	575.9685
	3.45	575.9652
-20	3.0	575.9624
	2.55	575.9712
	3.45	575.9638
55	3.0	575.9678
	2.55	575.9737
	3.45	575.9751
Max. frequency error (ppm)		-28.0
Limit(ppm)		±50ppm

## Transmit B

Test conditions		Frequency Error
Temperature(°C)	Voltage(V)	576.3900MHz
25	3.0	576.3812
	2.55	576.3824
	3.45	576.3844
-20	3.0	576.3783
	2.55	576.3846
	3.45	576.3798
55	3.0	576.3777
	2.55	576.3856
	3.45	576.3765
Max. frequency error (ppm)		-23.42
Limit(ppm)		±50ppm

Test conditions		Frequency Error
Temperature(°C)	Voltage(V)	585.8200MHz
25	3.0	585.8325
	2.55	585.8345
	3.45	585.8352
-20	3.0	585.8285
	2.55	585.8267
	3.45	585.8315
55	3.0	585.8362
	2.55	585.8302
	3.45	585.8289
Max. frequency error (ppm)		27.65
Limit(ppm)		±50ppm

Test conditions		Frequency Error
Temperature(°C)	Voltage(V)	595.6600MHz
25	3.0	595.6726
	2.55	595.6763
	3.45	595.6795
-20	3.0	595.6781
	2.55	595.6762
	3.45	595.6712
55	3.0	595.6781
	2.55	595.6735
	3.45	595.6748
Max. frequency error (ppm)		32.74
Limit(ppm)		±50ppm

Test Result: PASS

## 8. Transmitter Spurious Emissions & Emission mask

---

### 8.1 Standard Applicable

According to FCC 15.236(g), Emission within the band from one megahertz below to one megahertz above the carrier frequency shall comply with the emission mask in Section 8.3 of ETSI EN 300422-1 V1.4.2(2011-08). Emissions outside this band shall comply with the limit specified at the edges of the ETSI mask.

### 8.2 Test Procedure

Radiated Emission Test Set-Up, Frequency Below 1GHz

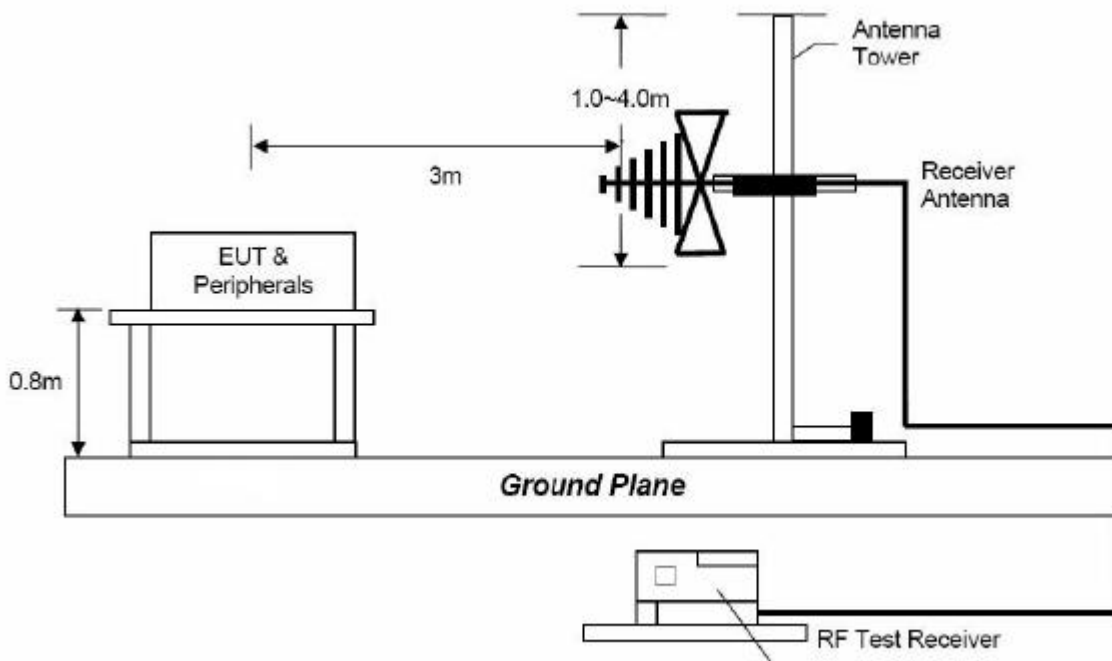
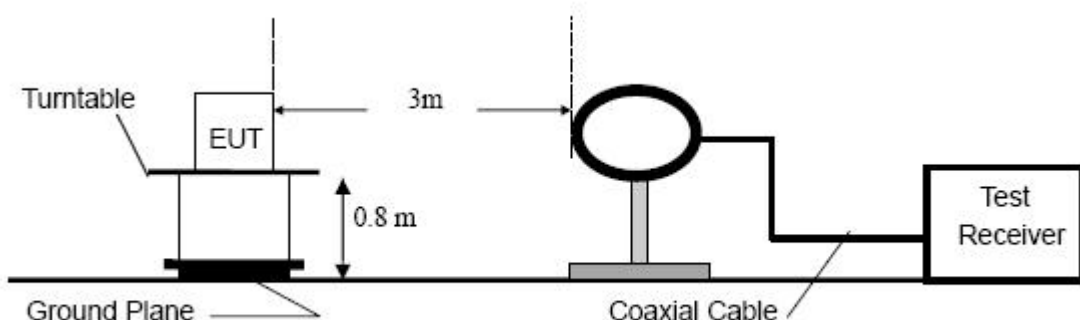

## Radiated Emission Test Set-Up, Frequency above 1GHz

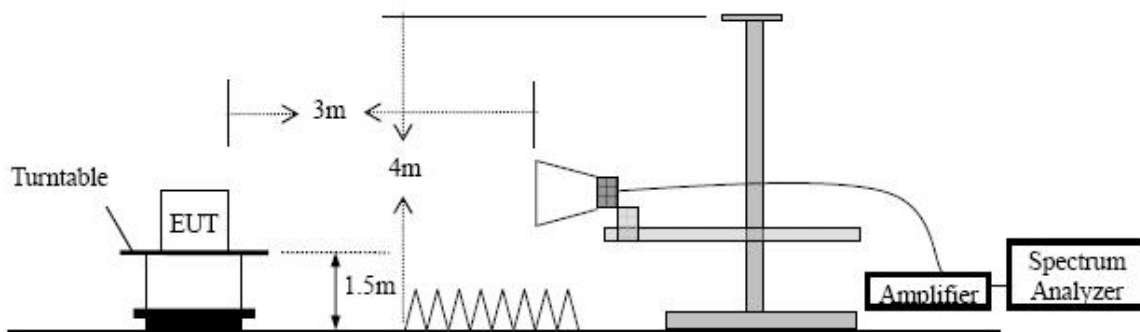

## Emission Mask Test set-up.

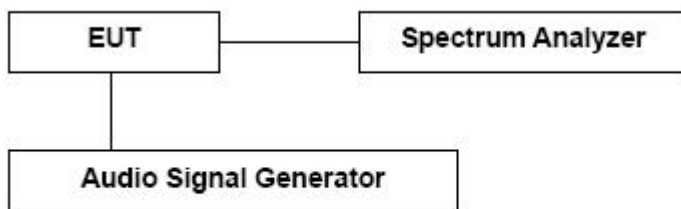

## Radiated spurious emission test procedure:

a. Below 1GHz, the EUT was placed on the top of a rotating table 0.8 meters above the ground at a 3 meter semi- anechoic chamber room.

b. For the radiated emission test above 1GHz:

The EUT was placed on the top of a rotating table 1.5 meters above the ground at a 3 meter full anechoic chamber room. The table was rotated 360 degrees to determine the position of the highest radiation. Place the measurement antenna away from each area of the EUT determined to be a source of emissions at the specified measurement distance, while keeping the measurement antenna aimed at the source of emissions at each frequency of significant emissions, with polarization oriented for maximum response. The measurement antenna may have to be higher or lower than the EUT, depending on the radiation pattern of the emission and staying aimed at the emission source for receiving the maximum signal. The final measurement antenna elevation shall be that which maximizes the emissions. The measurement antenna elevation for maximum emissions shall be restricted to a range of heights of from 1 m to 4 m above the ground or reference ground plane.

c. The EUT was set 3 meters away from the interference-receiving antenna, which was mounted on the top of a variable-height antenna tower.

d. The height of antenna is varied from one meter to four meters above the ground to determine the maximum value of the field strength. Both horizontal and vertical

polarizations of the antenna are set to make the measurement.

e. For each suspected emission, the EUT was arranged to its worst case and then the antenna was tuned to heights from 1 meter to 4 meters and the rotatable table was turned from 0 degrees to 360 degrees to find the maximum reading. The test-receiver system was set to peak detect function and specified bandwidth with maximum hold mode.

f. A Quasi-peak measurement was then made for that frequency point for below 1GHz test. Peak and /or AVG for above 1GHz emission test.

During the radiated emission test, the spectrum analyzer was set with the following configurations:

Frequency Band (MHz)	Level	Resolution Bandwidth	Video Bandwidth
30 to 1000	QP	120 kHz	300 kHz
Above 1000	Peak	1 MHz	3 MHz
	Average	1 MHz	10 Hz or 3MHz

Emission Mask test procedure:

Necessary Bandwidth (BN) for Analogue Systems

Method of Measurement

The arrangement of test equipment as shown in figure B.1 shall be used. Note that the noise meter conforms to (quasi peak) without weighting filter (flat).

With the Low Frequency (LF) audio signal generator set to 500 Hz, the audio input level to the EUT shall be adjusted to 8 dB below the limiting threshold (-8 dB (lim)) as declared by the manufacturer.

The corresponding audio output level from the demodulator shall be measured and recorded.

The input impedance of the noise meter shall be sufficiently high to avoid more than 0,1 dB change in input level when the meter is switched between input and output.

The audio input level shall be increased by 20 dB, i.e. to +12 dB (lim), and the corresponding change in output level shall be measured.

It shall be checked that the audio output level has increased by  $\leq 10$  dB.

If this condition is not met, the initial audio input level shall be increased from -8 dB (lim) in 1 dB steps until the above condition is fulfilled, and the input level recorded in the test report. This level replaces the value derived from the manufacturer's declaration and is defined as -8 dB (lim).

If the transmitter incorporates more than one audio input, e.g. stereo systems, the second and subsequent channels shall be simultaneously driven from the same noise source, attenuated to a level of -6 dB (lim).

The transmitter RF output spectrum shall be measured, using a spectrum analyser with the following settings:

- centre frequency:  $f_c$ : Transmitter (Tx) nominal frequency;
- dispersion (Span):  $f_c - 1$  MHz to  $f_c + 1$  MHz;
- Resolution BandWidth (RBW): 1 kHz;
- Video BandWidth (VBW): 1 kHz; - detector: Peak hold.



Limits for spurious emissions

State	Frequency		
	47MHz to 74MHz 87.5MHz to 137MHz 174MHz to 230MHz 470MHz to 862MHz	Other frequencies Blow 1000MHz	Frequency above 1000MHz
Operation	4nW(-54dBm)	250nW(-36dBm)	1uW(-30dBm)
Standby	2nW(-57dBm)	2nW(-57dBm)	20nW(-57dBm)

Measured valued for equipment in each frequency band must fall below the values given in table above.

Limits for Emission Mask

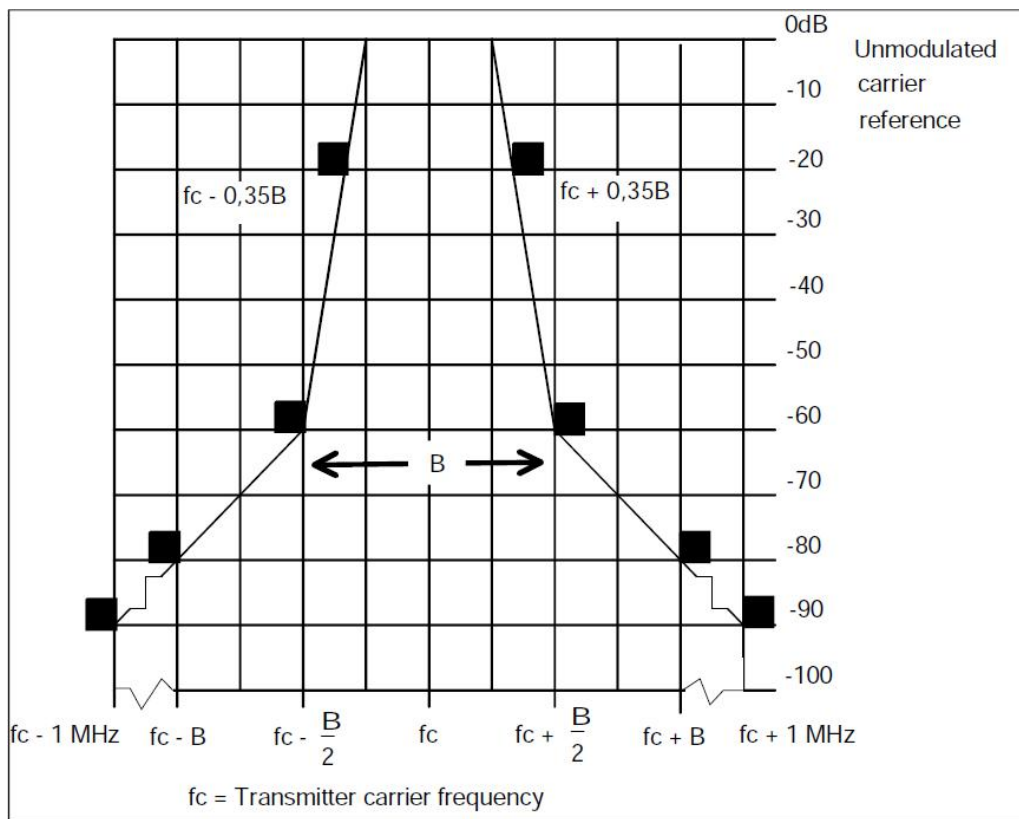

8.4 Environmental Conditions

Temperature:	25 °C
Relative Humidity:	52%
ATM Pressure:	1012 mbar

## 8.5 Summary of Test Results/Plots

-1.29 dB at 857.0247 MHz in the Vertical polarization,30 MHz to 2 GHz,3Meters

Spurious Emission from 30MHz to 1GHz

Test Mode: Transmitting

Only Show the worst case

Horizontal:

No.	Frequency (MHz)	Result (dBm)	Limit (dBm)	Margin (dB)	Height (cm)	Remark
1	42.3625	-61.52	-36.00	-25.52	100	peak
2	53.3524	-65.65	-54.00	-11.65	100	peak
3	71.6589	-68.58	-54.00	-14.58	100	peak
4	115.8451	-71.85	-54.00	-17.85	100	peak
5	402.3512	-64.65	-54.00	-10.65	100	peak
6	562.9654	-69.62	-54.00	-15.62	100	peak

Vertical:

No.	Frequency (MHz)	Result (dBm)	Limit (dBm)	Margin (dB)	Height (cm)	Remark
1	62.1313	-63.63	-54.00	-9.63	150	peak
2	96.7622	-66.52	-54.00	-12.52	150	peak
3	185.8240	-69.84	-36.00	-33.84	150	peak
4	235.6904	-68.95	-54.00	-14.95	150	peak
5	395.4273	-69.35	-54.00	-15.35	150	peak
6	574.4034	-67.57	-54.00	-13.57	150	peak

Spurious Emission Above 1GHz

Frequency	SG Reading	Angle	Height	Polar	Result dBm	Limit dBm	Margin dB
MHz	dBm	Degree	Meter	H/V			
2226.84	-45.35	252	1.4	H	-42.62	-30	-12.62
2226.84	-42.24	312	1.4	V	-44.35	-30	-14.35
2783.55	-43.51	126	1.5	H	-42.24	-30	-12.24
2783.55	-44.68	135	1.6	V	-40.68	-30	-10.68
3340.26	-48.57	154	1.6	H	-45.57	-30	-15.57
3340.26	-51.91	198	1.6	V	-47.94	-30	-17.94

Standby mode does not cause any spurious emissions and no peak detected.

Mask Emission

Transmit A

556.710MHz

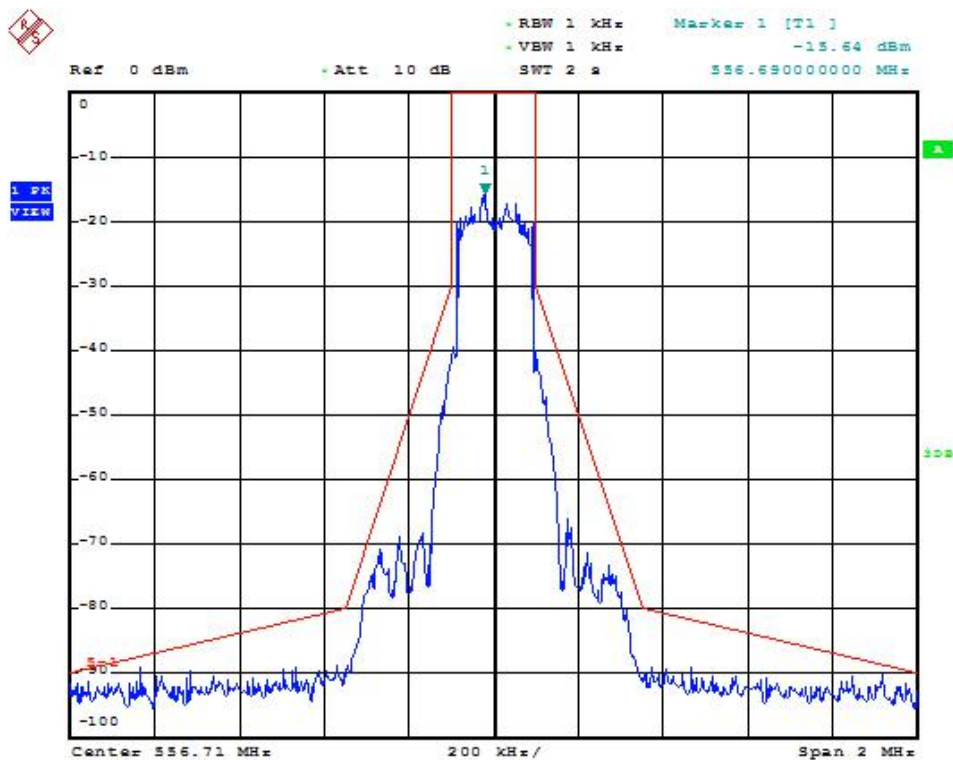

566.140MHz

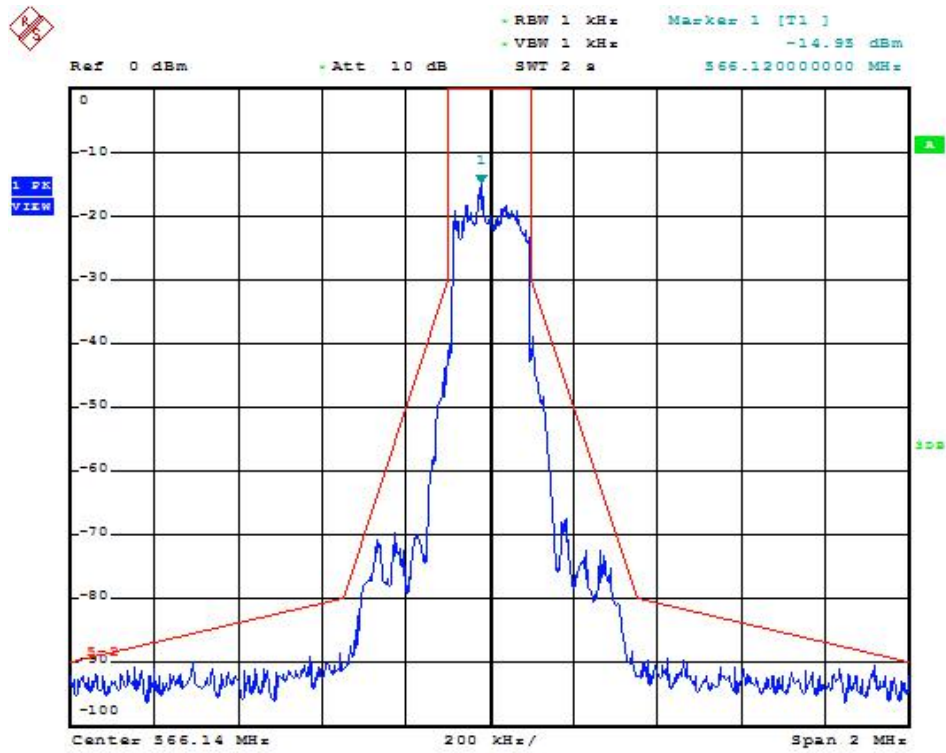

575.980MHz

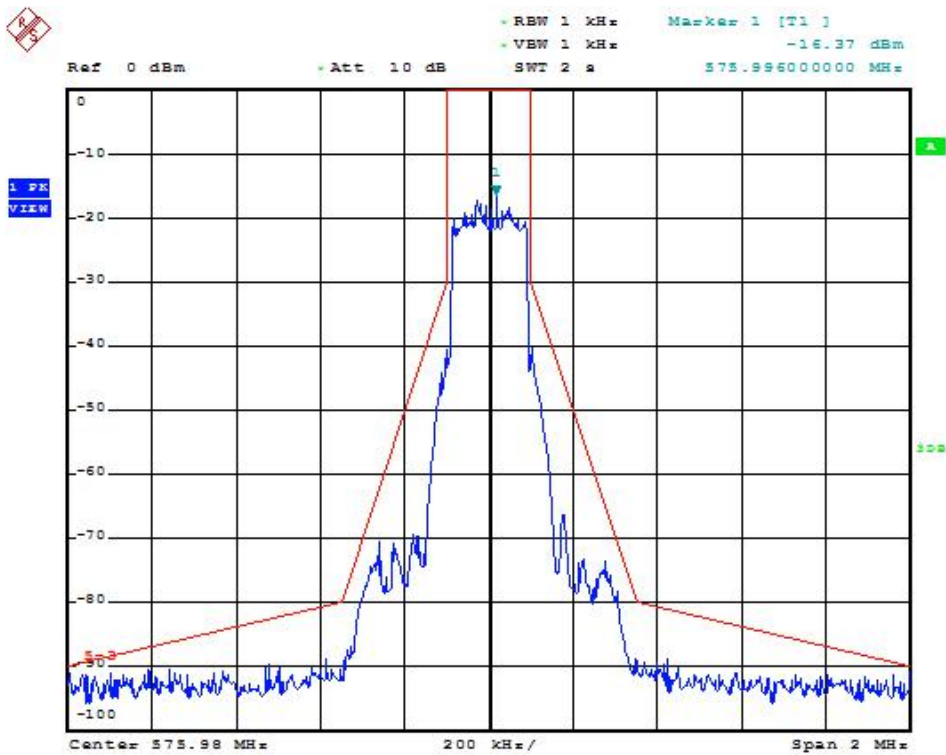

Transmit B

576.39MHz

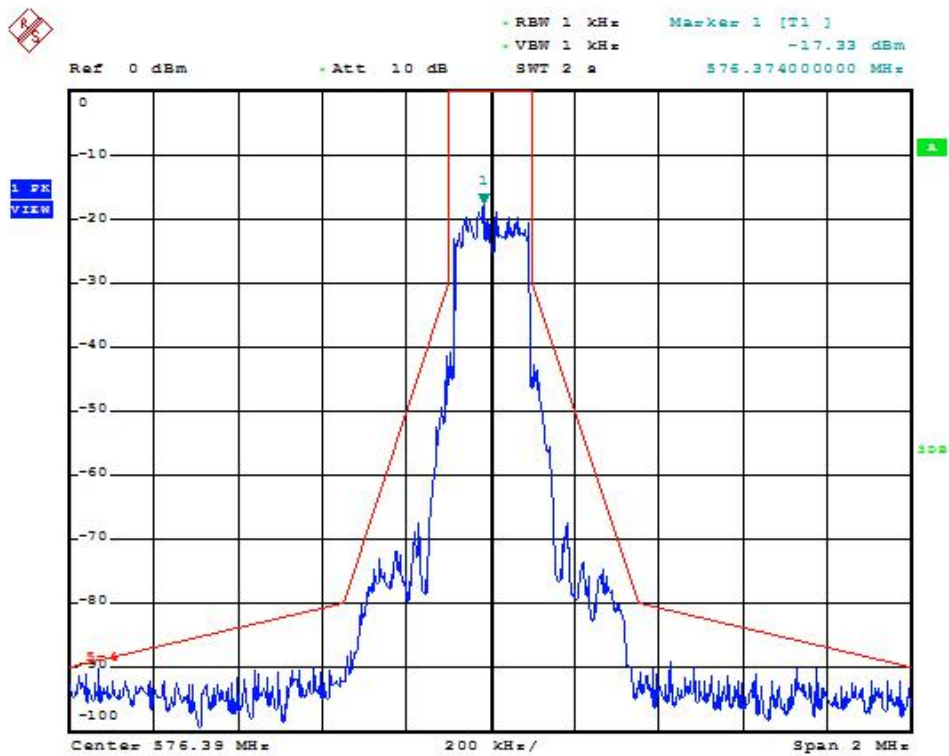

585.82MHz

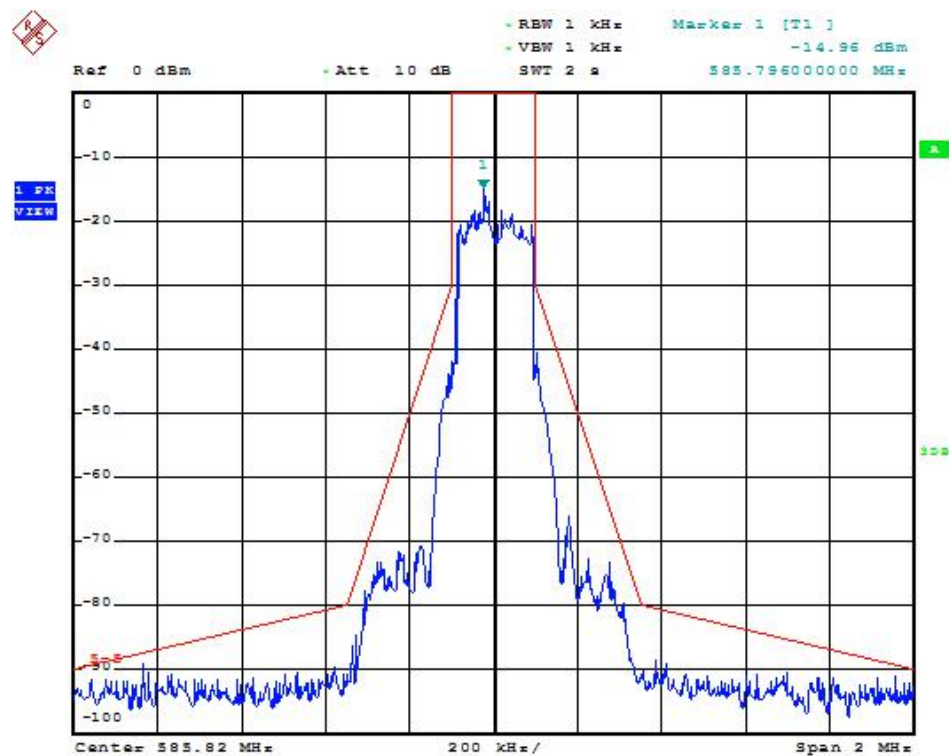

595.660MHz

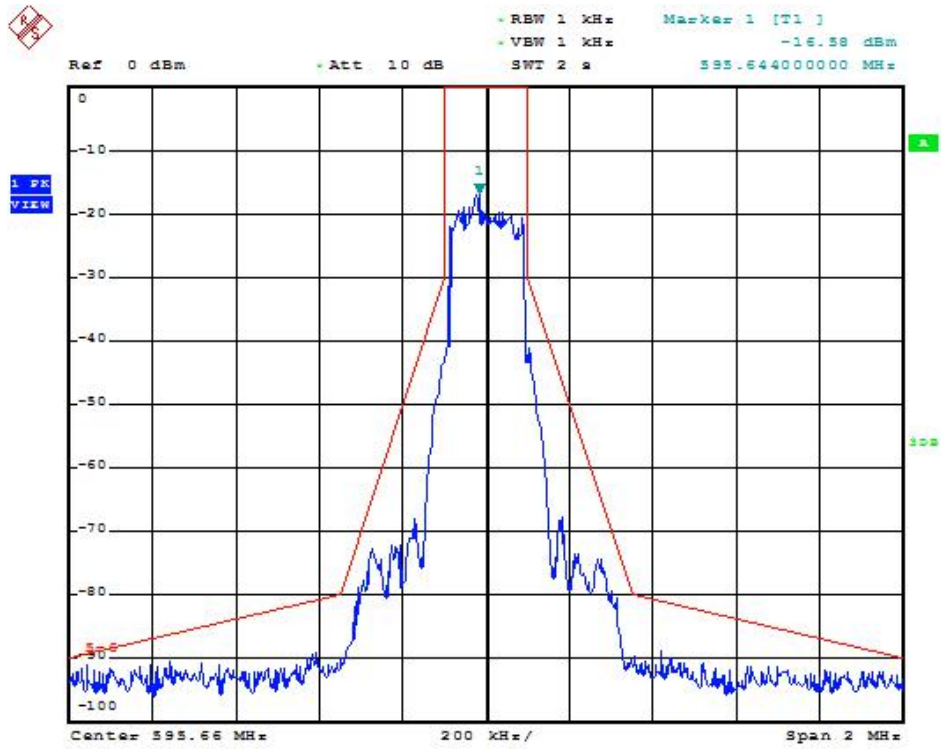

## 10. Conducted Emissions

### 10.1 Test Procedure

The setup of EUT is according with per ANSI C63.4-2014 measurement procedure. The specification used was with the FCC Part 15.207 Limit.

The external I/O cables were draped along the test table and formed a bundle 30 to 40 cm long in the middle. The spacing between the peripherals was 10 cm.

### 10.2 Basic Test Setup Block Diagram

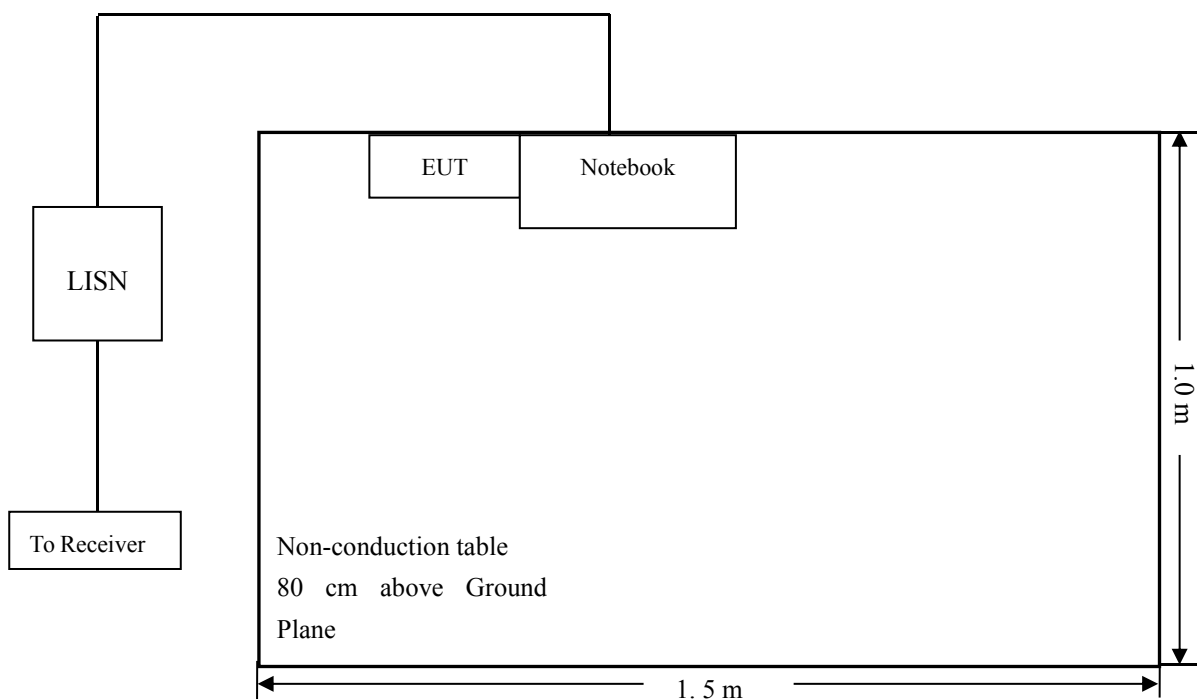

### 10.3 Environmental Conditions

Temperature:	25 °C
Relative Humidity:	52%
ATM Pressure:	1012 mbar

### 10.4 Test Receiver Setup

During the conducted emission test, the test receiver was set with the following configurations:

Start Frequency..... 150 kHz  
Stop Frequency..... 30 MHz  
Sweep Speed..... Auto  
IF Bandwidth..... 10 kHz  
Quasi-Peak Adapter Bandwidth..... 9 kHz  
Quasi-Peak Adapter Mode..... Normal

### 10.5 Summary of Test Results/Plots

According to the data in section 10.6, the EUT complied with the FCC Part 15.207 Conducted margin for this device

### 10.6 Conducted Emissions Test Data

N/A:DC 3V from battery

\*\*\*\*\* END OF REPORT \*\*\*\*\*