

Saramonic®

Sound.Remarkable. 声

Ultracompact 2.4 GHz Dual-Channel
Wireless Microphone System

2.4GHz 迷你双通道无线麦克风系统

Blink500 Pro

User Manual

用户手册

General Introduction

The Saramonic Blink500 Pro is an incredibly lightweight, ultracompact and easy-to-use 2-person wireless microphone system, and delivers an exceptional, broadcast-quality sound for DSLR, Mirrorless and Video cameras, mobile devices, and much more.

Includes the Blink500 Pro Charging Box, it allows you to charge devices anywhere you need. This box provides the charging power for transmitter and receiver, and it's rechargeable via a USB-C port in low battery level.

3.5mm headphone output, selectable M/S switch, quick-charging, OLED display on TX, quick-charging TX features make the recording process more quicker to focus.

The system series is comprised of three different receivers. The RX receiver has a 3.5mm output and includes TRS and TRRS output cables, allowing it to work with any device with a 3.5mm audio input. The RXDi receiver has a MFi Certified Lightning output and is designed for Apple iOS devices. And the RXUC receiver has a USB-C output and is designed for devices with a USB-C port, including Android smartphones and tablets.

The clip-on transmitter has a great sounding built-in mic and it is small and light enough to clip to shirts and clothing, or you can use it as a traditional beltpack transmitter with the included SR-M1 professional lavalier microphone.

No technical knowledge of audio is required to operate. The Blink500 Pro system operates on the interference-free 2.4GHz spectrum and automatically hops to free channels to avoid static noise and audio dropouts.

Available Series:

Model	In the box
Blink500 Pro B1(TX+RX)	1×Blink500 Pro RX 1×Blink500 Pro TX
Blink500 Pro B1W(TX+RX)	1×Blink500 Pro RXW 1×Blink500 Pro TXW
Blink500 Pro B2(TX+TX+RX)	1×Blink500 Pro RX 2×Blink500 Pro TX
Blink500 Pro B2W(TX+TX+RX)	1×Blink500 Pro RXW 2×Blink500 Pro TXW
Blink500 Pro B3(TX+RXDi)	1×Blink500 Pro RXDi 1× Blink500 Pro TX
Blink500 Pro B4(TX+TX+RXDi)	1×Blink500 Pro RXDi 2× Blink500 Pro TX
Blink500 Pro B5(TX+RXUC)	1×Blink500 Pro RXUC 1× Blink500 Pro TX
Blink500 Pro B6(TX+TX+RXUC)	1×Blink500 Pro RXUC 2× Blink500 Pro TX

Note: *If using an Android phone, please set the “OTG Connection” to “ON.” The OTG connection menu is usually in the “Additional Settings” in your phone setting menu.*

Product Structure

1. Blink500 Pro TX: Body-pack Transmitter with OLED Display and Microphone

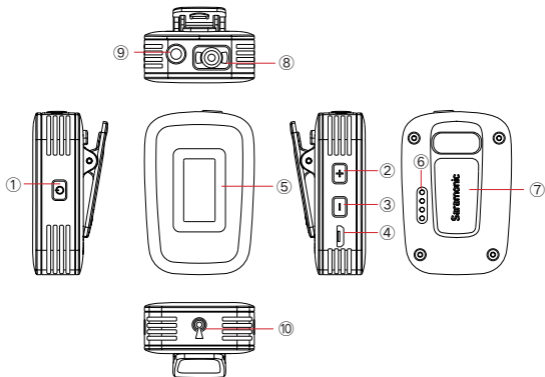

① Power/Mute Button

Function	Operation
Power ON	Press button for 3 second or longer
Power OFF	Press button until it turns off
Mute ON	Short press button
Mute OFF	

② +/SET Button

Function	Operation
+	Short press the SET button to select functions or values shown on the display.
SET	Long press the SET button to enter the displayed menu. Then, long press the SET button again to confirm your option.

③ - Button

Short press the SET button to select functions or values shown on the display. Then, long press the SET button again to confirm your option.

④ Micro USB Charging Port (DC 5V)

⑤ OLED Display

Display menus, please refer to "OLED Display Operation Guide" for more details.

⑥ Charging & Pairing Contacts

⑦ Belt Clip

⑧ Built-in Microphone

⑨ MIC/LINE IN Jack

It can be connected to the 3.5mm lavalier microphone or line-in devices.

⑩ Antenna

2. Blink500 RX: Clip-On and Shoe-Mountable Receiver

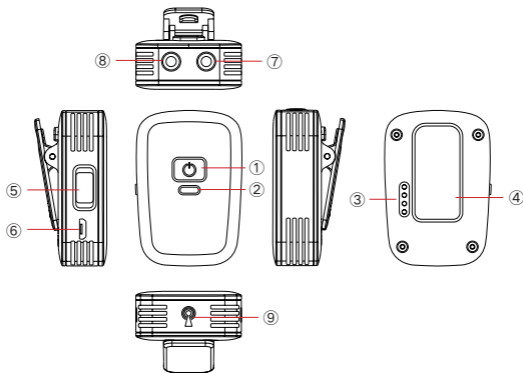

① Power/Mute Button

Function	Operation
Power ON	Press button for one second or longer
Power OFF	Press button until it turns off
Mute ON	Short press button
Mute OFF	

② POWER/MUTE Indicator

Mode	Indicator Status
Power ON (unpaired mode)	Flashes Blue Light
Mute ON	Solid Red Light
Paired Successfully	Solid Blue Light
Charging	Flashes Red Light
Fully Charged	Red Lights off

③ Charging & Pairing Contacts

④ Belt Clip with a Standard Cold Shoe Mount

⑤ M/S Switch

⑥ Micro USB Charging Port (DC 5V)

⑦ LINE OUT Jack

Connect the Blink500 Pro RX to a DSLR camera, smartphone with a 3.5mm headphone jack, mixer or amplifier with the supplied output cable.

⑧ 3.5mm Headphone Output

Connect a headphone to monitor the audio output.

⑨ Antenna

3. Blink500 RXUC: USB-C Receiver

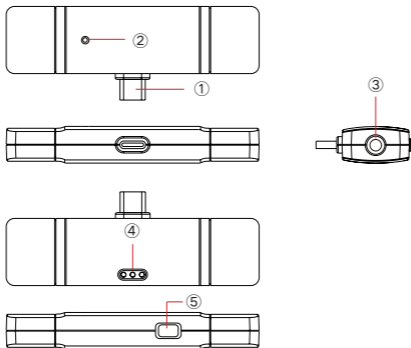

① USB-C Connector

② Pairing Indicator

Mode	Indicator Status
Unpaired	Flashes Blue Light
Paired Successfully	Solid Blue Light

③ 3.5mm Headphone Output

Connect a headphone to monitor the audio output.

④ Pairing Contacts

⑤ M/S Switch

4. Blink500 RXDi: Lightning Receiver

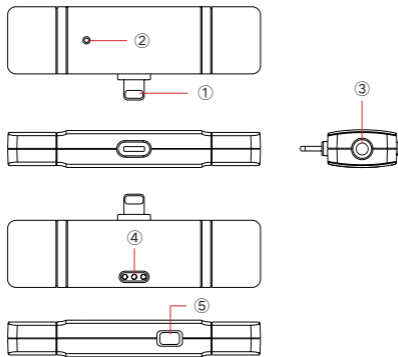

① MFi Certified Apple Lightning Connector

② Pairing Indicator

Mode	Indicator Status
Unpaired	Flashes Blue Light
Paired Successfully	Solid Blue Light

③ 3.5mm Headphone Output



Connect a headphone to monitor the audio output.

④ Pairing Contacts

⑤ M/S Switch

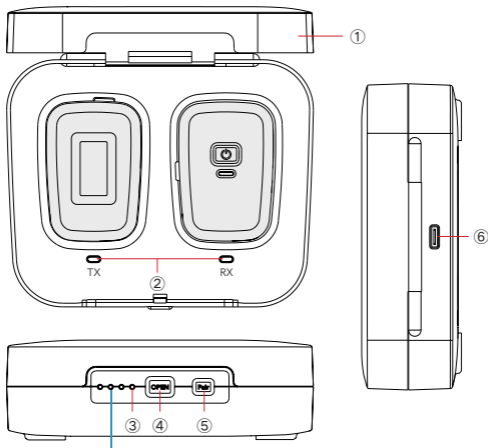
5. Charging Box

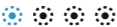

Indicator	Status
	Charging (Flashes blue light in circle)
	Current Box's Battery Level
	Low Battery

① Charging Box Cover

② TX & RX Charging Indicator

Charging =Solid Red Light

Fully Charged=Lights Off

③ Power Capacity Indicator

④ Pair Button

⑤ OPEN Button

⑥ USB-C Charging Port (DC 5V)

OLED Display Operation Guide

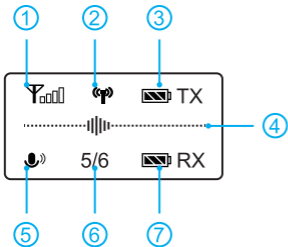

Home screen

If no operation is performed for 20 seconds on the other screens, the display will automatically return to the home screen.

① RF level indicator

② Pairing indicator



Paired Successfully



Disconnected

For details on setting the level, please see "Operatiol Guide" (page).

③ TX's Battery level indicator

Displays the TX battery level. Please recharge the device immediately when the indicator starts flashing.

④ Audio input level meter

Displays the audio input level

⑤ Input mode

The input mode can be selected to Mic in or Line in. When the input mode is Mic in mode, the receiver can be connected to the 3.5mm lavalier microphone. When the input mode is Line in mode, the receiver can be connected to the line-in devices. System default is "Mic in".

⑥ MIC GAIN

If you want adjust the microphone's gain, you can set the microphone's gain from 00-06.

Default is "05".

⑦ RX's Battery level indicator

Displays the RX battery level. Please recharge the device immediately when the indicator starts flashing.



MIC GAIN. Adjust the microphone's gain value as request (0-6). Default is "5".



Input mode. The input mode can be selected to Mic in or Line in. When the input mode is Mic in mode, the transmitter can be connected to the 3.5mm lavalier microphone. When the input mode is Line in mode, the receiver can be connected to the line-in devices. System default is "Mic in".

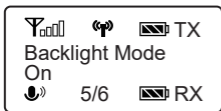

Set Backlight. Select On or Delay 10 / 30 /60 seconds. Default is "On."



Set Mute key. When in muting mode, please select "Enable" and long press the SET button again to confirm your option. Default is "Enable".



Language Setting

English/ 简体中文



Restore default setting.

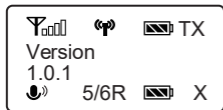

Version of the Blink500 Pro TX.

Operation Guide

For the Blink500 Pro B1/B2 kit

1. Turn on the transmitter TX by long pressing the power key.
2. Turn on the receiver RX by long pressing the power key.
3. Press hard the pairing button of charging box.
4. The kit will be paired when the pair indicator of OLED display of TX should be indicate RX battery level, and the pairing indicator should be shown "".
5. Connect the receiver RX to the mic jack of a camera, camcorder, recorder or mixer with the supplied 3.5mm TRS audio cable. Or connect the RX to a smartphone or tablet with the supplied 3.5mm TRS to TRRS audio cable.
6. You are ready to record.

Note: The output of receiver RX is line out. You can connect it to speaker system. To avoid noise during connection, before connecting the receiver to a speaker system, please mute the speaker system and do not use the headphones.

For the Blink500 Pro B3/B4/B5/B6 kit

1. Turn on the transmitter by long pressing the power key.
2. Press hard the pairing button of charging box.
3. The kit will be paired when the pair indicator of OLED display of TX should be shown "".
4. Plug the RXDi into an iOS device or the RXUC into an USB Type-C device. Please make sure the antenna (yellow side) is oriented on the top of the device, when in landscape mode, to get the best signal.
5. You are ready to record.

Specification

Blink500 Pro RXUC	
Transmission Type	2.4GHz Digital Frequency
Modulation	GFSK
Operating Range	Up to 328' (100m)
Audio Output Connector	USB-C Connector
Power Requirements	Supplied by USB-C Devices
Other functions	3.5mm headphone jack, M/S switch
Antenna	PIFA Antenna
Weight	Approx. 10.5g (0.37oz)
Dimensions	31×82×12mm
Operating Temperature	0°C to 50°C
Storage Temperature	-20°C to +55°C

Blink500 Pro RXDi	
Transmission Type	2.4GHz Digital Frequency
Modulation	GFSK
Operating Range	Up to 328' (100m)
Audio Output Connector	MFi Certified Lightning connector
Power Requirements	Supplied by iOS Devices
Other functions	3.5mm headphone jack, M/S switch
Antenna	PIFA Antenna
Weight	Approx. 10.5g (0.37oz)
Dimensions	31×82×12mm
Operating Temperature	0°C to 50°C
Storage Temperature	-20°C to +55°C

Blink500 Pro RX/RXW	
Transmission Type	2.4GHz Digital Frequency
Modulation	GFSK
Operating Range	Up to 328' (100m)
Audio Output Connector	3.5 mm Jack
Audio Output level	-60dBV to -20dBV
Power Requirements	Built-in Li-ion Battery or Micro USB DC 5V or Charging Contact
Other functions	3.5mm headphone jack, M/S switch, mute function
Built-In Battery Life	Approx. 8 hours
Antenna	PIFA Antenna
Weight	Approx. 26.5g (0.93oz)
Dimensions	56×38×29.4mm
Operating Temperature	0°C to 50°C
Storage Temperature	-20°C to +55°C

Blink500 Pro BOX Charging Case	
Power Requirements	Powered by USB-C port(5V/1.5A)
Power Capacity	2000mAh(TX+TX+RX)/1200mAh(TX+RX)
Box's Charging Time	2.5 hours (Fully charged)
Weight	B1/B1W: Approx. 26.5g (0.93oz)
	B2/ B2W:
	B3:
	B4:
	B5:
Dimensions	B6:
	B1/B1W: 123.3×102.9×39.7mm
	B2/B2W:165.8×102.9×39.7mm
	B3:123.3×102.9×39.7mm
	B4:165.8×102.9×39.7mm
Operating Temperature	B5:123.3×102.9×39.7mm
	B6:165.8×102.9×39.7mm
Storage Temperature	0°C to 50°C
Storage Temperature	-20°C to +55°C

Blink500 Pro TX/TXW	
Transmission Type	2.4GHz Digital Frequency
Modulation	GFSK
Operating Range	Up to 328' (100m)
RF Output Power	10mW
Polar Pattern	Omnidirectional
Frequency Response	50Hz-18KHz
Maximum SPL	Built-In Microphone: 120dB SPL Lavalier Microphone: 110dB SPL
Sensitivity	Built-In Microphone: -39dB Lavalier Microphone: -39dB
SNR	> 78dB
Reference audio input level	-30~-42dBv (MIC input, 0 dB attenuation)
Power Requirements	Built-in Li-ion Battery or Micro USB DC 5V or Charging Contact
Other Functions	3.5mm headphone jack, mute function High-contrast OLED Display
Built-In Battery Life	Approx. 8 hours
Antenna	PIFA Antenna
Audio Inputs	3.5mm TRS Lavalier Mic/Line-in Input or Built-in Microphone
Weight	Approx. 26.5g (0.93oz)
Dimensions	56.5×38×26.1mm
Operating Temperature	0°C to 50°C
Storage Temperature	-20°C to +55°C

Packing List

Blink500 Pro B1(1×Blink500 Pro RX+1×Blink500 Pro TX)

- 1× Blink500 Pro RX Receiver with Built-In Clip and Camera Shoe-Mount
- 1× Blink500 Pro TX Transmitter with OLED Display and Built-In Microphone
- 1× Blink500 Pro B1 BOX Charging Case
- 1× 1' (30.5 cm) Gold-Plated 3.5mm TRS to TRS Output Cable for Cameras
- 1× 1' (30.5 cm) Gold-Plated 3.5mm TRS to TRRS Output Cable for Smartphones and Tablets
- 1× 1' (30.5 cm) Gold-Plated USB-C to USB-A Charging Cables
- 1× 1' (30.5 cm) Gold-Plated Micro USB to USB-A Charging Cables
- 1× SR-M1 Omnidirectional Lavalier Microphone
- 1× Alligator-Style Lavalier Microphone Clip
- 1× Foam Lavalier Windscreen
- 1× Warranty Card
- 1× User Manual

Blink500 Pro B2(1×Blink500 Pro RX+2×Blink500 Pro TX)

- 1× Blink500 Pro RX Receiver with Built-In Clip and Camera Shoe-Mount
- 2× Blink500 Pro TX Transmitter with OLED Display and Built-In Microphone
- 1× Blink500 Pro B2 BOX Charging Case
- 1× 1' (30.5 cm) Gold-Plated 3.5mm TRS to TRS Output Cable for Cameras
- 1× 1' (30.5 cm) Gold-Plated 3.5mm TRS to TRRS Output Cable for

Smartphones and Tablets

- 1× 1' (30.5 cm) Gold-Plated USB-C to USB-A Charging Cables
- 1× 1' (30.5 cm) Gold-Plated Micro USB to USB-A Charging Cables
- 2× SR-M1 Omnidirectional Lavalier Microphone
- 2× Alligator-Style Lavalier Microphone Clip
- 2× Foam Lavalier Windscreen
- 1× Warranty Card
- 1× User Manual

Blink500 Pro B3(1×Blink500 Pro RXDi +1×Blink500 Pro TX)

- 1× Blink500 Pro RXDi Receiver with MFi Certified Apple Lightning Connector
- 1× Blink500 Pro TX Transmitter with OLED Display and Built-In Microphone
- 1× Blink500 Pro B3 BOX Charging Case
- 1× 1' (30.5 cm) Gold-Plated USB-C to USB-A Charging Cables
- 1× 1' (30.5 cm) Gold-Plated Micro USB to USB-A Charging Cables
- 1× SR-M1 Omnidirectional Lavalier Microphone
- 1× Alligator-Style Lavalier Microphone Clip
- 1× Foam Lavalier Windscreen
- 1× Warranty Card
- 1× User Manual

Blink500 Pro B4(1×Blink500 Pro RXDi +2×Blink500 Pro TX)

- 1× Blink500 Pro RXDi Receiver with MFi Certified Apple Lightning Connector
- 2× Blink500 Pro TX Transmitter with OLED Display and Built-In Microphone
- 1× Blink500 Pro B4 BOX Charging Case

- 1× 1' (30.5 cm) Gold-Plated USB-C to USB-A Charging Cables
- 1× 1' (30.5 cm) Gold-Plated Micro USB to USB-A Charging Cables
- 2× SR-M1 Omnidirectional Lavalier Microphone
- 2× Alligator-Style Lavalier Microphone Clip
- 2× Foam Lavalier Windscreen
- 1× Warranty Card
- 1× User Manual

Blink500 Pro B5(1×Blink500 Pro RXUC+ 1×Blink500 Pro TX)

- 1× Blink500 Pro RXUC Receiver with USB-C Connector
- 1× Blink500 Pro TX Transmitter with OLED Display and Built-In Microphone
- 1× Blink500 Pro B5 BOX Charging Case
- 1× 1' (30.5 cm) Gold-Plated USB-C to USB-A Charging Cables
- 1× 1' (30.5 cm) Gold-Plated Micro USB to USB-A Charging Cables
- 1× SR-M1 Omnidirectional Lavalier Microphone
- 1× Alligator-Style Lavalier Microphone Clip
- 1× Foam Lavalier Windscreen
- 1× Warranty Card
- 1× User Manual

Blink500 Pro B6(1×Blink500 Pro RXUC+ 2×Blink500 Pro TX)

- 2× Blink500 Pro RXUC Receiver with USB-C Connector
- 1× Blink500 Pro TX Transmitter with OLED Display and Built-In Microphone
- 1× Blink500 Pro B6 BOX Charging Case
- 1× 1' (30.5 cm) Gold-Plated USB-C to USB-A Charging Cables
- 1× 1' (30.5 cm) Gold-Plated Micro USB to USB-A Charging Cables

- 2× SR-M1 Omnidirectional Lavalier Microphone
- 2× Alligator-Style Lavalier Microphone Clip
- 2× Foam Lavalier Windscreen
- 1× Warranty Card
- 1× User Manual

Blink500 Pro B1W(1×Blink500 Pro RXW+1×Blink500 Pro TXW)

- 1× Blink500 Pro RXW Receiver with Built-In Clip and Camera Shoe-Mount
- 1× Blink500 Pro TXW Transmitter with OLED Display and Built-In Microphone
- 1× Blink500 Pro B1W BOX Charging Case
- 1× 1' (30.5 cm) Gold-Plated 3.5mm TRS to TRS Output Cable for Cameras
- 1× 1' (30.5 cm) Gold-Plated 3.5mm TRS to TRRS Output Cable for Smartphones and Tablets
- 1× 1' (30.5 cm) Gold-Plated USB-C to USB-A Charging Cables
- 1× 1' (30.5 cm) Gold-Plated Micro USB to USB-A Charging Cables
- 1× SR-M1W Omnidirectional Lavalier Microphone
- 1× Alligator-Style Lavalier Microphone Clip
- 1× Foam Lavalier Windscreen
- 1× Warranty Card
- 1× User Manual

Blink500 Pro B2W(1×Blink500 Pro RXW+2×Blink500 Pro TXW)

1× Blink500 Pro RXW Receiver with Built-In Clip and Camera Shoe-Mount

2× Blink500 Pro TXW Transmitter with OLED Display and Built-In Microphone

1× Blink500 Pro B2W BOX Charging Case

1× 1' (30.5 cm) Gold-Plated 3.5mm TRS to TRS Output Cable for Cameras

1× 1' (30.5 cm) Gold-Plated 3.5mm TRS to TRRS Output Cable for Smartphones and Tablets

1× 1' (30.5 cm) Gold-Plated USB-C to USB-A Charging Cables

1× 1' (30.5 cm) Gold-Plated Micro USB to USB-A Charging Cables

2× SR-M1W Omnidirectional Lavalier Microphone

2× Alligator-Style Lavalier Microphone Clip

2× Foam Lavalier Windscreen

1× Warranty Card

1× User Manual

概述

Saramonic Blink500 Pro 是迷你双通道无线麦克风系统。输送广播级音质，适用于单反、无反相机、摄像机以及其他移动设备。本系统分别有 RX/RXDi/RXUC 三款接收器系列。

包括 Blink500 Pro 充电盒，它允许你在任何需要的地方给设备充电。充电盒为发射器和接收器提供充电电源，低电量时可通过 USB-C 接口充电。

3.5mm 耳机输出，可选择的 M/S 开关，自带 OLED 屏幕（发射器）快速充电功能，让您快速聚焦于您的录音对象。

RX 是 3.5mm TRS 接收器，配置 TRS 和 TRRS 输出线，用于 3.5mm TRS 和 TRRS 接口设备。

RXDi 为通过 MFi 认证 Lightning 接收器，用于 iOS 系统的 Lightning 接口设备。RXUC 为 Type-C 接收器，用于安卓以及其他 Type-C 接口设备。

背夹式发射器有内置麦克风，能够收录优质的音质效果，轻便小巧的外形可以夹在衣服上使用。您也可以把它当成传统的腰包发射器，搭配套装内提供的 SR-M1 领夹麦使用。无需专业知识即可操作使用。Blink500 系统所使用的是抗干扰 2.4GHz 频段，遇到干扰情况下能自动跳转频道避免噪音产生以及音频失真。

Blink500 Pro 组合套装

型号	套装内容
Blink500 Pro B1(TX+RX)	1×Blink500 Pro RX 1×Blink500 Pro TX
Blink500 Pro B1W(TX+RX)	1×Blink500 Pro RXW 1×Blink500 Pro TXW
Blink500 Pro B2(TX+TX+RX)	1×Blink500 Pro RX 2×Blink500 Pro TX
Blink500 Pro B2W(TX+TX+RX)	1×Blink500 Pro RXW 2×Blink500 Pro TXW
Blink500 Pro B3(TX+RXDi)	1×Blink500 Pro RXDi 1× Blink500 Pro TX
Blink500 Pro B4(TX+TX+RXDi)	1×Blink500 Pro RXDi 2× Blink500 Pro TX
Blink500 Pro B5(TX+RXUC)	1×Blink500 Pro RXUC 1× Blink500 Pro TX
Blink500 Pro B6(TX+TX+RXUC)	1×Blink500 Pro RXUC 2× Blink500 Pro TX

注意：如果您使用的是安卓手机，请在设置里打开 OTG 功能。OTG 功能通常在设置菜单的“更多设置”中选择。

产品结构

1. Blink500 Pro TX：背夹式接收器（可接入相机热靴座）

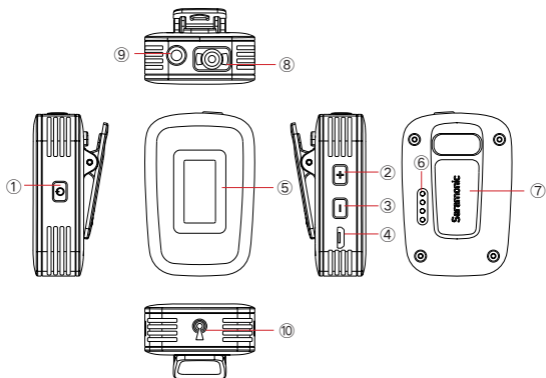

① 电源 / 静音键

功能	操作
电源开启	长按按键（3 秒以上）
电源关闭	长按按键直至关闭
静音开启	短按按键
静音关闭	

② +/SET 设置键

功能	操作
+	短按调整各参数值
SET	长按设置键进入选定界面，再次长按保存设定

③ - 键

短按 - 键调整各参数值，长按 set 键保存设置的参数

④ Micro USB 充电口（直流电 5V）

⑤ OLED 显示屏

详情请参考“OLED 屏幕操作指南”

⑥ 充电 & 配对触点

⑦ 背夹

⑧ 内置麦克风

⑨ 麦克风 / 线性输入

连接 3.5mm 领夹麦 / 线性输入设备

⑩ 天线

2. Blink500 Pro RX

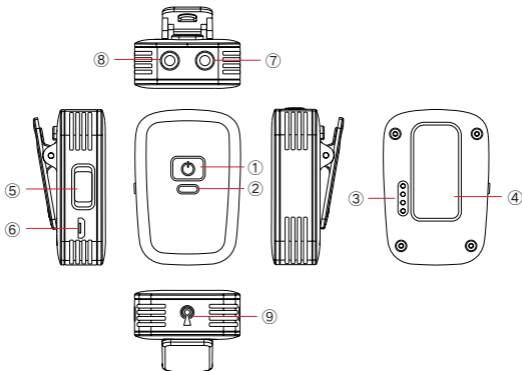

① 电源 / 静音键

功能	操作
电源开启	长按按键（3 秒以上）
电源关闭	长按按键直至关闭
静音开启	短按按键
静音关闭	

② 电源 / 静音指示灯

功能	操作
电源开启（未配对）	闪蓝灯
静音开启	红灯常亮
配对成功	蓝灯常亮
充电中	闪红灯
充电完成	红灯

③ 充电 & 配对触点

④ 背夹

⑤ 单声道 / 立体声切换键

⑥ Micro USB 充电口 (直流电 5V)

⑦ 线性输出

使用相应的输出线，连接至单反相机，手机，混音器等设备

⑧ 3.5mm 耳机监听孔

插入耳机进行监听

⑨ 天线

3. Blink500 Pro RXUC

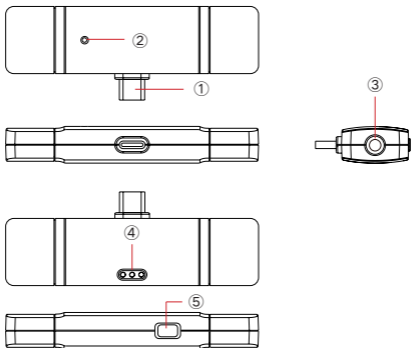

① USB-C 输出接口

② 配对指示灯

模式	指示灯状态
未配对	闪蓝灯
配对成功	蓝灯常亮

③ 3.5mm 耳机监听孔

插入耳机进行监听

④ 对码触点

⑤ 单声道 / 立体声切换键

4. Blink500 Pro RXDI

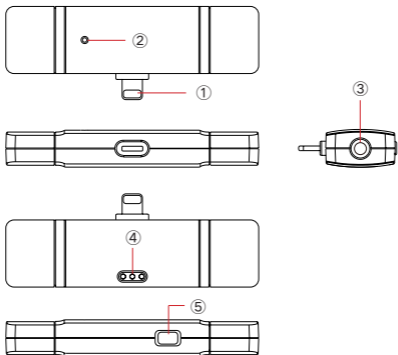

① MFi 苹果认证 Lightning 接口

② 配对指示灯

模式	指示灯状态
未配对	闪蓝灯
配对成功	蓝灯常亮

③ 3.5mm 耳机监听孔

插入耳机进行监听

④ 对码触点

⑤ 单声道 / 立体声切换键

5. Blink500 Pro Charging Box 充电盒

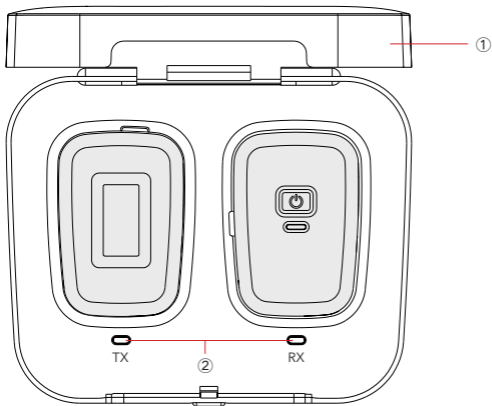

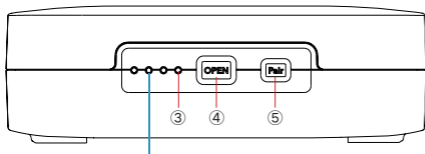

指示灯	指示灯状态
	充电 (蓝灯依次闪烁)
	当前电量
	低电量 (蓝灯快速闪烁)

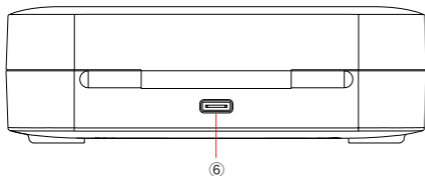

① 充电盒盖

② TX&RX 充电指示灯

充电中 = 红灯闪烁

充满电 = 指示灯熄灭

③ 充电盒电量指示灯

④ 按压式开关

⑤ 配对键

⑥ USB-C 充电口

OLED 显示操作指南

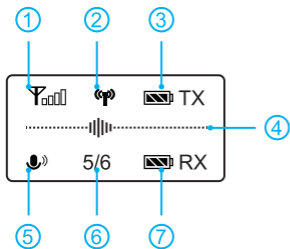

主菜单界面

如果超过 20 秒不操作，显示屏会自动跳转回主菜单界面。

① 射频信号指示灯

② 配对指示灯



配对成功



未配对

③ 发射器电量指示灯

显示发射器电量情况，若图标为空格且开始闪烁，请及时进行充电。

④ 输入电平大小

显示输入电平大小

⑤ 输入模式

长按 SET 键设置发射器输入控制麦克风 / 线性输入模式。

麦克风输入模式：3.5mm 领夹麦克风接入。（系统默认设置）

线性输入：3.5mm 线性设备接入。

⑥ 麦克风增益

麦克风增益值调节范围（0-6），默认值是“5”

⑦ 接收器电量指示灯

显示接收器电量情况，若图标为空格且开始闪烁，请及时进行充电。

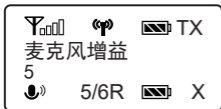

麦克风增益：麦克风增益值调节范围（0-6），默认值是“5”

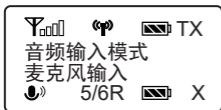

麦克风输入模式：3.5mm 领夹麦克风接入。（系统默认设置）

线性输入模式：线性输入设备接入。



LED 背光灯设置：常亮 / 60/30/10 秒设定，（常亮 为系统默认设定）

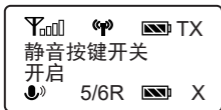

静音设置键：在静音模式下，选择“开启”并长按 set 键保存设置。“开启”为系统默认设置。



语言设置：English/ 简体中文



确认恢复出厂设置后，Blink500 Pro TX 的相关参数将被恢复到默认出厂值。



Blink500 Pro TX 版本号

操作指南

Blink500 B1/B2 套装

1. 长按电源键打开发射器 TX。
2. 长按电源键打开接收器 RX。
发射器和接收器的出厂默认设置是已配对成功，若无成功连接，请进行下一步配对操作。
3. 长按充电盒的配对键。
4. 若配对成功，TX 主菜单界面中会显示 RX 电量，配对图标显示“”。
5. 包装配置两条输出线：分别是 3.5mm TRS 音频输出线和 3.5mm TRRS 音频输出线。
3.5mm TRS 音频输出线用于相机，摄影机，录音机和混音器。3.5mm TRRS 音频输出线用于手机和平板电脑等移动设备。
6. 开始你的录音

提示：接收器输出孔是线性输出。您可将接收器连接到音响系统上。在连接之前，请勿使用耳机并将音响系统调至静音模式，以免产生啸叫情况。

Blink500 B3/B4/B5/B6 套装

1. 长按电源键打开发射器
2. 长按充电盒的配对键。
3. 若配对成功，TX 主菜单界面中显示“”。
4. 将 RXDi 插入 iOS 系统的 Lightning 设备 /RXUC 插入 Type-C 设备。为获得最佳信号，请确保天线（黄边）位置朝上。发射器和接收器的出厂默认设置是已配对成功。若无成功连接，请进行下一步配对操作。
5. 开始录音

参数

Blink500 Pro RXUC	
使用频段	2.4GHz 数字频段
信号调制	高斯频移键控
操作范围	最远至 100 米（无障碍）
音频输出口	Type-C 接口
电池类型	Type-C 设备供电
其他功能	3.5mm 耳机监听孔，单声道立体声切换键
天线	PIFA 天线
重量	大约 10.5g (0.37oz)
尺寸	31 × 82 × 12mm
工作温度	0 ° C to 50 ° C
贮存温度	- 20 ° C to +55 ° C

Blink500 Pro RXDi	
使用频段	2.4GHz 数字频段
信号调制	高斯频移键控
操作范围	最远至 100 米（无障碍）
音频输出口	MFi 认证 Lightning
电池类型	iOS 设备供电设备供电
其他功能	3.5mm 耳机监听孔，单声道立体声切换键
天线	PIFA 天线
重量	大约 10.5g (0.37oz)
尺寸	31 × 82 × 12mm
工作温度	0 ° C to 50 ° C
贮存温度	- 20 ° C to +55 ° C

Blink500 Pro RX/RXW	
使用频段	2.4GHz 数字频段
信号调制	高斯频移键控
操作范围	最远至 100 米 (无障碍)
音频输出口	3.5mm 接口
电池类型	内置锂电池供电 / 充电盒触点充电 / Micro USB 5V 充电口
其他功能	3.5mm 耳机监听孔, 单声道立体声切换键, 静音功能
内置电池使用时长	大约 8 小时
天线	PIFA 天线
重量	大约 26.5g (0.93oz)
尺寸	56 × 38 × 29.4mm
工作温度	0°C to 50°C
贮存温度	-20 ° C to +55 ° C

Blink500 Pro BOX Charging Case	
供电方式	Type-C 孔 (5V/1.5A)
充电盒电池容量	2000mAh(TX+TX+RX)/1200mAh(TX+RX)
充电盒充电时间	2.5 小时 (完全充满)
重量	B1:
	B2: 大约 367.5g (12.96oz)
	B3:
	B4:
	B5:
	B6:
尺寸	B1: 123.3 × 102.9 × 39.7mm
	B2: 165.8 × 102.9 × 39.7mm
	B3: 123.3 × 102.9 × 39.7mm
	B4: 165.8 × 102.9 × 39.7mm
	B5: 123.3 × 102.9 × 39.7mm
	B6: 165.8 × 102.9 × 39.7mm
工作温度	0°C to 50°C
贮存温度	-20°C to +55°C

Blink500 Pro TX/TXW	
使用频段	2.4GHz 数字频段
信号调制	高斯频移键控
操作范围	最远至 100 米 (无阻碍)
RF 输出功率	10mW
拾音模式	全向型
频率响应	50Hz-18KHz
最大 SPL	内置麦克风 :120dB SPL 领夹麦克风 : 110dB SPL
灵敏度	内置麦克风 : -39dB 领夹麦克风 : -39dB
信噪比	> 78dB
电池要求	内置锂电池供电 / 充电盒触点充电 /Micro USB 5V 充电口
内置电池使用时长	约 8 小时
天线	PIFA 天线
音频输入源	3.5mm 麦克风 / 线性输入, 内置麦克风
重量	34g
尺寸	56.5 × 38 × 26.1mm
工作温度	0°C to 50°C
贮存温度	- 20 ° C to +55 ° C

包装清单

Blink500 Pro B1(1 × Blink500 Pro RX+1 × Blink500 Pro TX)

- 1 × Blink500 Pro RX 背夹式接收器（可接入相机热靴座）
- 1 × Blink500 Pro TX 便携式发射器（内置 OLED 屏幕和麦克风）
- 1 × Blink500 Pro B1 BOX 充电盒
- 1 × 30.5cm 镀金 3.5mm TRS 转 TRS 相机输出线
- 1 × 30.5cm 镀金 3.5mm TRS 转 TRRS 手机和平板电脑输出线
- 1 × 30.5cm 镀金 Type-C 接口转 USB-A 充电线
- 1 × 30.5cm 镀金 Micro USB 接口转 USB-A 充电线
- 1 × SR-M1 全向型领夹麦
- 1 × 领夹
- 1 × 领夹麦防风棉
- 1 × 保修卡
- 1 × 用户手册

Blink500 Pro B2(1 × Blink500 Pro RX+2 × Blink500 Pro TX)

- 1 × Blink500 Pro RX 背夹式接收器（可接入相机热靴座）
- 2 × Blink500 Pro TX 便携式发射器（内置 OLED 屏幕和麦克风）
- 1 × Blink500 Pro B2 BOX 充电盒
- 1 × 30.5cm 镀金 3.5mm TRS 转 TRS 相机输出线
- 1 × 30.5cm 镀金 3.5mm TRS 转 TRRS 手机和平板电脑输出线
- 1 × 30.5cm 镀金 Type-C 接口转 USB-A 充电线
- 1 × 30.5cm 镀金 Micro USB 接口转 USB-A 充电线
- 2 × SR-M1 全向型领夹麦
- 2 × 领夹
- 2 × 领夹麦防风棉
- 1 × 保修卡
- 1 × 用户手册

Blink500 Pro B3(1 × Blink500 Pro RXDi +1 × Blink500 Pro TX)

- 1 × Blink500 Pro RXDi 接收器（ MFi 认证的 Lightning 接口）
- 1 × Blink500 Pro TX 便携式发射器（ 内置 OLED 屏幕和麦克风）
- 1 × Blink500 Pro B3 BOX 充电盒
- 1 × 30.5cm 镀金 Type-C 接口转 USB-A 充电线
- 1 × 30.5cm 镀金 Micro USB 接口转 USB-A 充电线
- 1 × SR-M1 全向型领夹麦
- 1 × 领夹
- 1 × 领夹麦防风棉
- 1 × 保修卡
- 1 × 用户手册

Blink500 Pro B4(1 × Blink500 Pro RXDi +2 × Blink500 Pro TX)

- 1 × Blink500 Pro RXDi 接收器（ MFi 认证的 Lightning 接口）
- 2 × Blink500 Pro TX 便携式发射器（ 内置 OLED 屏幕和麦克风）
- 1 × Blink500 Pro B4 BOX 充电盒
- 1 × 30.5cm 镀金 Type-C 接口转 USB-A 充电线
- 1 × 30.5cm 镀金 Micro USB 接口转 USB-A 充电线
- 2 × SR-M1 全向型领夹麦
- 2 × 领夹
- 2 × 领夹麦防风棉
- 1 × 保修卡
- 1 × 用户手册

Blink500 Pro B5(1 × Blink500 Pro RXUC+ 1 × Blink500 Pro TX)

- 1 × Blink500 Pro RXUC 接收器 (Type-C 接口)
- 1 × Blink500 Pro TX 便携式发射器 (内置 OLED 屏幕和麦克风)
- 1 × Blink500 Pro B5 BOX 充电盒
- 1 × 30.5cm 镀金 Type-C 接口转 USB-A 充电线
- 1 × 30.5cm 镀金 Micro USB 接口转 USB-A 充电线
- 1 × SR-M1 全向型领夹麦
- 1 × 领夹
- 1 × 领夹麦防风棉
- 1 × 保修卡
- 1 × 用户手册

Blink500 Pro B6(1 × Blink500 Pro RXUC+ 2 × Blink500 Pro TX)

- 1 × Blink500 Pro RXUC 接收器 (Type-C 接口)
- 2 × Blink500 Pro TX 便携式发射器 (内置 OLED 屏幕和麦克风)
- 1 × Blink500 Pro B6 BOX 充电盒
- 1 × 30.5cm 镀金 Type-C 接口转 USB-A 充电线
- 1 × 30.5cm 镀金 Micro USB 接口转 USB-A 充电线
- 2 × SR-M1 全向型领夹麦
- 2 × 领夹
- 2 × 领夹麦防风棉
- 1 × 保修卡
- 1 × 用户手册

Blink500 Pro B1W(1 × Blink500 Pro RXw+1 × Blink500 Pro TXw)

Blink500 B1 (TXW+RXW)

- 1 × Blink500 Pro RXW 背夹式接收器 (可接入相机热靴座)
- 1 × Blink500 Pro TXW 便携式发射器 (内置 OLED 屏幕和麦克风)
- 1 × Blink500 Pro B1W BOX 充电盒
- 1 × 30.5cm 镀金 3.5mm TRS 转 TRS 相机输出线
- 1 × 30.5cm 镀金 3.5mm TRS 转 TRRS 手机和平板电脑输出线
- 1 × 30.5cm 镀金 Type-C 接口转 USB-A 充电线
- 1 × 30.5cm 镀金 Micro USB 接口转 USB-A 充电线
- 1 × SR-M1W 全向型领夹麦
- 1 × 领夹
- 1 × 领夹麦防风棉
- 1 × 保修卡
- 1 × 用户手册

Blink500 Pro B2W(1 × Blink500 Pro RXw+2 × Blink500 Pro TXw)

Blink500 B2w (TXw+TXw+RXw)

- 1 × Blink500 Pro RXw 背夹式接收器 (可接入相机热靴座)
- 2 × Blink500 Pro TXw 便携式发射器 (内置 OLED 屏幕和麦克风)
- 1 × Blink500 Pro B2w BOX 充电盒
- 1 × 30.5cm 镀金 3.5mm TRS 转 TRS 相机输出线
- 1 × 30.5cm 镀金 3.5mm TRS 转 TRRS 手机和平板电脑输出线
- 1 × 30.5cm 镀金 Type-C 接口转 USB-A 充电线
- 1 × 30.5cm 镀金 Micro USB 接口转 USB-A 充电线
- 2 × SR-M1 全向型领夹麦
- 2 × 领夹
- 2 × 领夹麦防风棉
- 1 × 保修卡
- 1 × 用户手册

FCC Caution:

Any Changes or modifications not expressly approved by the party responsible for compliance could void the user's authority to operate the equipment.

This device complies with part 15 of the FCC Rules. Operation is subject to the following two conditions: (1) This device may not cause harmful interference, and (2) this device must accept any interference received, including interference that may cause undesired operation.

IMPORTANT NOTE:

Note: This equipment has been tested and found to comply with the limits for a Class B digital device, pursuant to part 15 of the FCC Rules. These limits are designed to provide reasonable protection against harmful interference in a residential installation. This equipment generates, uses and can radiate radio frequency energy and, if not installed and used in accordance with the instructions, may cause harmful interference to radio communications. However, there is no guarantee that interference will not occur in a particular installation. If this equipment does cause harmful interference to radio or television reception, which can be determined by turning the equipment off and on, the user is encouraged to try to correct the interference by one or more of the following measures:

- Reorient or relocate the receiving antenna.
- Increase the separation between the equipment and receiver.
- Connect the equipment into an outlet on a circuit different from that to which the receiver is connected.
- Consult the dealer or an experienced radio/TV technician for help.