

# Saramonic

Sound.Remarkable. 

## Blink1 System

FCC ID:2ARN3-BLINK1TX

FCC ID:2ARN3-BLINK1RX

User Manual  
用户手册

## Statement

Please read this manual carefully before use and operate and store in strict accordance with the instructions provided. Please retain for future reference. For any issues that cannot be resolved with the user manual, please contact your retailer for assistance, or contact us at: [info@saramonic.com](mailto:info@saramonic.com).

## Cautions

1. Do not use the system underwater or unprotected in rainy conditions. Store in a cool, dry place.
2. Designed for use and storage at normal temperatures. Do not move the unit from overheated to cold conditions frequently, and keep away from heat sources such as heaters and ovens.
3. When in use or when storing, avoid contact with dust and moisture.
4. Do not subject the device to violent impacts, as this can damage the device.
5. To avoid acoustic feedback, do not operate the microphone in close proximity to loudspeakers.
6. For optimal sound performance, do not hold your hand against the lavalier microphone's head.

## General Introduction

The Saramonic Blink1 System is an ultra-compact and extremely lightweight professional camera-mountable dual wireless system. Designed to be extremely versatile, yet exceptionally easy-to-use, it allows users to just turn it on and start shooting. Delivering broadcast-quality sound to the cameras, recorders, mobile devices and more.

## Portable Receiver Blink1 RX

### Introduction

The Blink1 RX is a camera-mountable dual wireless receiver. It features a vivid OLED display, 3.5mm headphone output and 3.5mm line out with both TRS and TRRS output cables. Delivering crystal-clear broadcast-quality wireless sound to cameras, recorders and mobile device for up to two microphones. With up to 7-hours battery life per charge, it can also be charged or powered while in use via the USB-C DC 5v port with standard USB chargers and USB battery packs.

## Available Blink1 Systems

Model	In the box
Blink1 Kit2 (TX+TX+RX)	1×Blink1 RX 2×Blink1 TX

## Product Structure

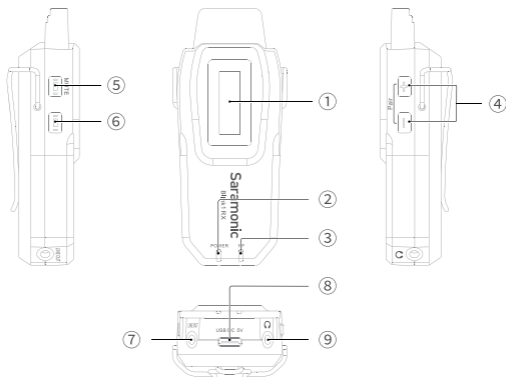

### ① OLED Display

Display menus and settings, please refer to "OLED Display Operation Guide" for more details.

### ② POWER Indicator

Status	Indicator
Power On/Fully Charged	Solid Blue Light
Low Battery	Solid Red Light
Low Battery (Alarming Status)	Flashing Red Light (Devices will turn off within 10 minutes)
Charging	Solid Red Light

### ③ RF Indicator

Status	Indicator
Unpaired	Lights Off
Paired Successfully	Solid Blue Light
MUTE	Flashing Blue Light

### ④ +/- Button (Pairing Button)

Function	Operation
+/-	Short press of the SET button to select functions or values shown on the display.
Pairing	Press the button "+" and "-" simultaneously for more than 3 seconds on the receiver and transmitter at the same time to enter into pairing mode.

### ⑤ Power / Mute Button

Function	Operation
Power ON	Press the button for one second or longer
Power OFF	Press the button until it turns off
Mute ON	Short press of the button
Mute OFF	

### ⑥ SET Button

Long press of the SET button to enter the displayed menu. Then, a short press of the SET button to confirm your setting change, or a long press again to exit without saving.

### ⑦ LINE OUT

### ⑧ USB-C Charging Port (DC 5V)

### ⑨ 3.5mm Headphone Jack

## OLED Display Operation Guide

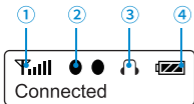

### 1. RF Level Indicator

Indicates the current signal level.

Signal is strong (Paired successfully)

Signal is undetected or system is unpaired

### 2. Connectivity

Paired successfully   Waiting for pairing

### 3. Audio Output

Mute On   Mute Off

### 4. Battery Level Indicator

Displays the RX battery level. Please recharge the device immediately when the indicator starts flashing.



### Set Contrast

If you want adjust the OLED display's contrast, you can set the contrast from 00-05. Default is "05."



### Set Mute Key

Enable or Disable Mute Key function. Default is "Enable".



Backlight 30s

### Set Backlight

Set the LED backlight to ON or Delay by 60, 30, or 10 seconds. Default setting is "Delay 30s."



English

### Language Setting

English or 简体中文 (Chinese) are available. Default is English.



Restore Default

### Restore to Factory Default Settings



Version 1.0.1

### Version of the Blink1 RX

Version of the Blink1 RX's firmware.

## Attaching Accessories

Attaching the shoe mount adapter.

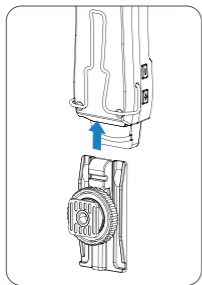

- ① Attach the belt clip, then hold receiver upside-down before attaching the shoe mount adapter.
- ② Push the bottom of the belt clip to make some space between the belt clip and the receiver.
- ③ Align the belt clip with the two vertical grooves on the shoe mount adapter and insert the adapter in the direction of the arrow under the belt clip.
- ④ Push the shoe mount adapter in fully until the belt clip fits into the horizontal groove on the shoe mount adapter's holder.

## Body-pack Transmitter Blink1 TX

### Introduction

The Blink1 TX is wireless belt-pack transmitter for the Blink1 RX receiver that features both microphone and line-level 3.5mm inputs. Extremely versatile, it allows users to use the included omnidirectional lavalier and other 3.5mm TRS microphones (sold separately), or a line-level audio source, like a mixer or music player output. Making the Blink1 system ideal for content creation, interviews, presentations, live streams, podcasts and much more. It features a one-touch mute button, a vivid OLED display, up to 7-hour battery life per charge and it can also be charged or powered while in use via the USB-C DC 5v port with standard USB chargers and USB battery packs.



## Product Structure

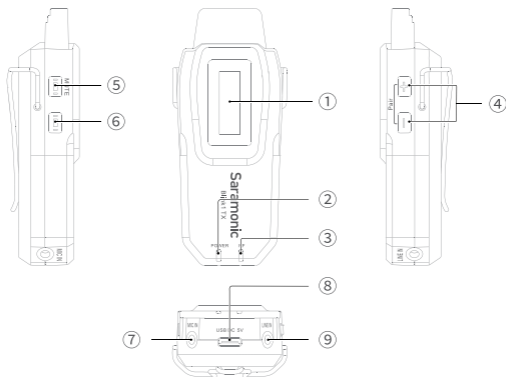

### ① OLED Display

Display menus and settings, please refer to "OLED Display Operation Guide" for more details.

### ② POWER Indicator

Status	Indicator
Power On/Fully Charged	Solid Blue Light
Low Battery	Solid Red Light
Low Battery (Alarming Status)	Flashing Red Light (Devices will turn off within 10 minutes)
Charging	Solid Red Light

### ③ RF Indicator

Status	Indicator
Unpaired	Lights Off
Paired Successfully	Solid Blue Light
MUTE	Flashing Blue Light

### ④ +/- Button (Pairing Button)

Function	Function
+/-	Short press of the SET button to select functions or values shown on the display.
Pairing	Press the button "+" and "-" simultaneously for more than 3 seconds on the receiver and transmitter at the same time to enter into pairing mode.

### ⑤ Power / Mute Button

Status	Operation
Power ON	Press the button for one second or longer
Power OFF	Press the button until it turns off
Mute ON	Short press of the button
Mute OFF	

### ⑥ SET Button

Long press of the SET button to enter the displayed menu. Then, a short press of the SET button to confirm your setting change, or a long press again to exit without saving.

### ⑦ MIC IN Jack

### ⑧ USB-C Charging Port (DC 5V)

### ⑨ LINE IN Jack

## OLED Display Operation Guide

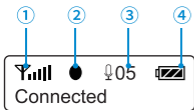

### 1. RF Level Indicator

Indicates the current signal level.

Signal is strong (Paired successfully)

Signal is undetected or system is unpaired

### 2. Connectivity

Paired successfully Waiting for pairing

### 3. Input Gain Level

Indicates microphone input level.

### 4. Battery Level Indicator

Displays the TX battery level. Please recharge the device immediately when the indicator starts flashing.



### Microphone Sensitivity

If you want adjust the transmitter's microphone input gain, you can set the input gain from 00-05. The default is "03".

   05   
Contrast 05

### Set Contrast

If you want adjust the OLED display's contrast, you can set the contrast from 00-05. Default is "05."

   05   
Backlight 30s

### Set Backlight

Set the LED backlight to ON or Delay by 60, 30, or 10 seconds. Default setting is "Delay 30s."





   05   
English

### Language Setting

English or 简体中文 (Chinese) are available. Default is English.

   05   
Restore Default

### Restore to Factory Default Settings

   05   
Version 1.0.1

### Version of the Blink1 TX

Version of the Blink1 TX's firmware.

## Attaching Accessories

### 1. Attaching a belt clip

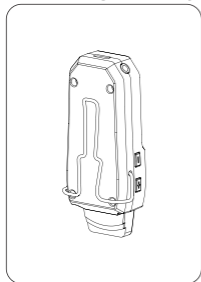

Insert one end of the belt clip into one of two holes on either side of the transmitter, and then insert the other end into the hole on the other side.

### 2. Connecting the microphone

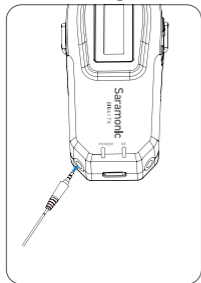

Note: Please turn off the transmitter before attaching or removing the microphone.

### 3. HOW TO USE?

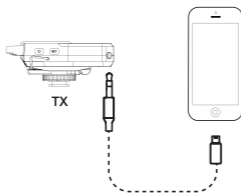
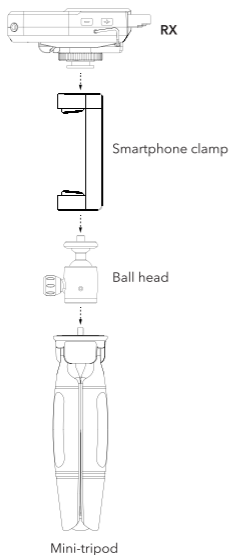

RX can be used for other device types via other cables, like 3.5mm to 3.5mm cable, 3.5mm to Type-C cable.

## Operation Guide

Before leaving the factory, the device has been paired successfully. If they are disconnected or unpaired, please follow the below steps:

### For the Blink1 TX and RX Pairing

1. Turn on the transmitter and receiver by a long press of the power buttons.
2. Press the + and - buttons simultaneously on the receiver for 3 seconds to enter into pairing mode. In this mode, the RF indicators quickly flash a blue light. Then repeat the same step on your transmitter.
3. When paired successfully, the RF indicators light solid blue.
4. You are ready to record.

**Note:** The output of receiver RX is a line-level out. You can connect it to a speaker system. To avoid noise during connection, before connecting the receiver to a speaker system or mixer, mute the input or speaker system and do not monitor with headphones while connecting.

## Specifications

Transmission Type	TDMA Digital Frequency
Modulation	GFSK
Operating Range	Up to 262' (80m) Without Obstacles
RF Output Power	10mW
Polar Pattern	Omnidirectional
Maximum SPL	110dB SPL
Frequency Response	50Hz~10kHz
Sensitivity	-30dB
Signal-to-Noise Ratio	> 75dB
Power Requirements	Built-In Li-ion Battery or USB-C DC 5V
Built-In Battery Life	TX: Approx. 7 hours RX: Approx. 5.5 hours
Antenna	PIFA Antenna
Audio Inputs	3.5mm TRS lavalier microphone input
Weight	TX: Approx. 86.5g (3.05oz) RX: Approx. 86.5g (3.05oz)
Dimensions	TX: 96x40.9x23.1mm (3.8x1.6x1") RX: 96x40.9x23.1mm (3.8x1.6x1")
Operating Temperature	0°C to 50°C
Storage Temperature	-20°C to +55°C



# Packing List

Portable Receiver:  
Blink1 RX (x1)



Body-pack Transmitter:  
Blink1 TX (x2)



SR-TP2 (x1)



MVC Smartphone  
Clamp (x1)



SK-T1 (x1)



SR-M1 Omnidirectional  
Lavalier Microphone (x2)



Foam  
Windshield (x2)



Mic Clip (x2)



Cold Shoe Mount  
Adapter (x1)



Belt Clip (x3)



SR-C8 Hard Case (x1)

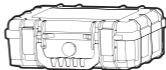

USB-C Charging Cables (x3)



SR-C2001 (x1)



SR-C2000 (x1)



3.5mm TRS Audio Cable for Cameras,  
Mixers and Recorders (x1)

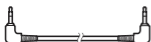

3.5mm TRRS Audio Cable for  
Mobile Devices (x1)

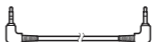

## 声明

请在使用前仔细阅读本手册，并严格按照说明进行操作和保存。请妥善保管以供将来参考。如果用户手册不能帮助您解决某些问题，请向零售商寻求帮助或给我们发送电子邮件：[info@saramonic.com](mailto:info@saramonic.com)。

## 注意事项

1. 请勿在水下使用本机，也不要使其受到雨淋。请存放在阴凉干燥处。
2. 请在常温下使用和存放。请勿经常性在冷热交替条件状态下使用设备，并远离加热器和烤箱等热源机器。
3. 使用和存放时，请注意防尘和防潮。
4. 切勿使装置受到剧烈撞击，以免损坏设备。
5. 为避免声音反馈，请勿将麦克风靠近扬声器。
6. 为获得最佳拾音模式，请勿将手放在麦克风顶部。

## 概述

Saramonic Blink1 系统它的用途非常广泛，也非常容易使用，为相机、录音机、移动设备等提供广播级音质。

## 便携式接收器 Blink1 RX

### 介绍

与相机和移动设备相比，Blink1 RX 的输出音质得到了显著改善，同时作为一种超小型无线系统，可以立即开箱即用，是视频拍摄、播客和移动新闻的理想选择。一旦插上设备开启电源，设置好录音设定，这样你的注意力就可以集中在录音上了。

## 产品组合

型号	套装内容
Blink1 Kit2 (TX+TX+RX)	1 × Blink1 RX 2 × Blink1 TX

## 产品结构

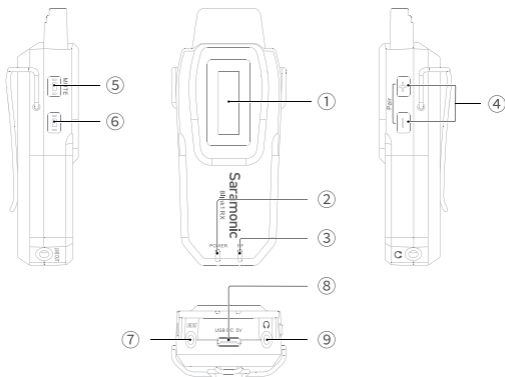

### ① OLED 屏幕

详情请参考“OLED 显示屏操作指南”

### ② 电源指示灯

状态	指示灯
开机 / 满电	蓝灯常亮
低电量	红灯常亮
低电量关机预警	红灯闪烁并在 10 分钟内关机
充电	红灯常亮

### ③ 射频指示灯

状态	指示灯
未对码状态	蓝灯熄灭
对码成功状态	蓝灯常亮
静音状态	蓝灯闪烁

### ④ 配对键

功能	操作
+/-	短按进行功能选择或音量调节
配对	同时长按接收器和发射器的“+”和“-”三秒，进入配对模式

### ⑤ 电源 / 静音按键

功能	操作
开启	长按电源键
关机	长按电源键直至设备关闭
静音模式	短按电源键切换模式
正常收音模式	

### ⑥ SET 键

长按 SET 键进入显示的菜单。然后短按 SET 键确认您的设置更改，或长按退出不保存。

### ⑦ 线性输出

### ⑧ Type-C 充电口 ( 直流电 5V )

### ⑨ 耳机监听孔

## OLED 界面指示

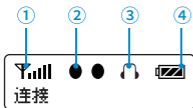

### 1. 射频信号强度

显示当前信号强度。

信号强（成功配对） 未配对状态

### 2. 连接

配对成功 等待配对（图标闪烁）

### 3. 耳机监听功能

静音开启 静音关闭

### 4. 电池电量

显示 RX 电池的电量。当电池图标开始闪烁时，请立即给设备充电。

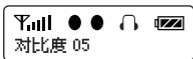

对比度设置：00-05（默认值为 05）。



静音键设置：开启 / 关闭静音功能（系统默认静音功能开启）。

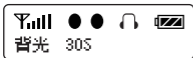

LED 背光灯设置：常亮或延时 60/30/10 秒（延迟 30s 为系统默认设定）。

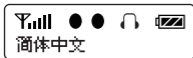

语言设置：英语 / 简体中文，系统默认英语。



确认恢复出厂设置后，Blink1 RX 的相关参数将被恢复到默认出厂值。

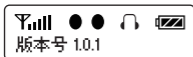

Blink1 RX 当前版本号。

## 配件安装

### 音频转接线接入操作

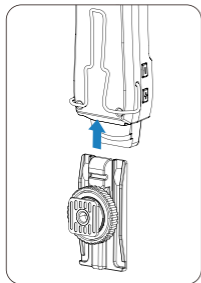

- ① 在安装卡板之前，请先将冷靴座卡板倒置。
- ② 按压背夹为卡板预留出空间。
- ③ 卡板凹槽必须对准与背夹的竖直方向位置。
- ④ 推入卡板，直至凹槽卡点到位，完成安装。

## 腰包发射器 Blink1 TX

### 介绍

Blink1 TX 背夹式发射器，是一款超小巧的专业发射器，适用于视频制作者、内容制作者、内容制作者或视频博客。简单和小巧的 Blink1 TX 随时随地为您录制清晰的音质。

### 产品结构

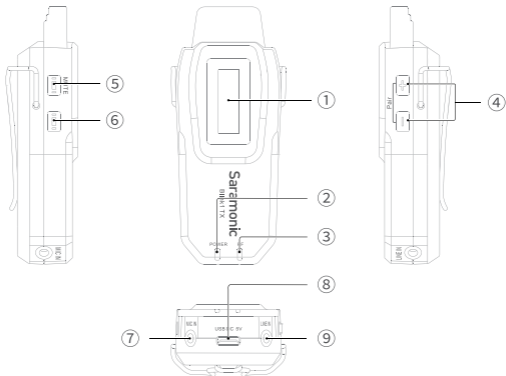



## ① OLED 屏幕

详情请参考“OLED 界面指示”

## ② 电源指示灯

状态	指示灯
开机 / 满电状态	蓝灯常亮
低电量	红灯常亮
低电量关机预警	红灯闪烁并在 10 分钟内关机
充电	红灯常亮

## ③ 射频指示灯

状态	指示灯
未对码状态	蓝灯熄灭
对码成功状态	蓝灯常亮
静音状态	蓝灯闪烁

## ④ 配对键

功能	操作
+/-	短按进行功能选择或音量调节
配对	同时长按接收器和发射器的“+”和“-”三秒，进入配对模式

## ⑤ 电源 / 静音按键

功能	操作
开启	长按电源键
关机	长按电源键直至设备关闭
静音模式	短按电源键切换模式
正常收音模式	

## ⑥ SET 键

长按 SET 键进入显示的菜单。然后短按 SET 键确认您的设置更改，或长按退出不保存。

## ⑦ 线性输出

## ⑧ Type-C 充电口 ( 直流电 5V )

## ⑨ 耳机监听孔

## OLED 界面指示

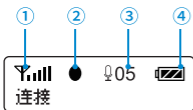

### 1. 射频信号强度

显示当前信号强度。

Y 信号强 ( 成功配对 )    Y 未配对状态

### 2. 连接

● 配对成功    ● 等待配对 ( 图标闪烁 )

### 3. 麦克风音量

显示麦克风输入音量

### 4. 电池电量

显示 TX 电池的电量。当电池图标开始闪烁时，请立即给设备充电。



麦克风灵敏度设置：麦克风增益设置范围 00-05（03 为系统默认设定）。

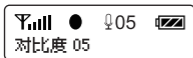

对比度设置：00-05（默认值为 05）。



静音键设置：开启 / 关闭静音功能（系统默认静音功能开启）。



LED 背光灯设置：常亮或延时 60/30/10 秒（延迟 30s 为系统默认设定）。

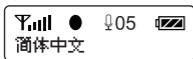

语言设置：英语 / 简体中文，系统默认英语。

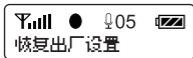

确认恢复出厂设置后，Blink1 TX 的相关参数将被恢复默认出厂值。

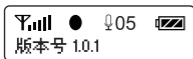

Blink1 TX 当前版本号。

## 配件安装

1. 将金属背夹对准发射器两侧的插入孔

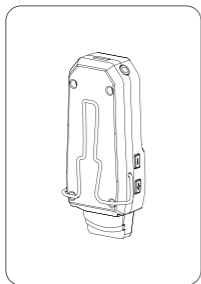

2. 接入麦克风

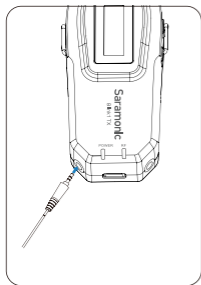

注意：在安装拆卸领夹麦之前，请先关闭发射器。

## 2. 如何使用三脚架

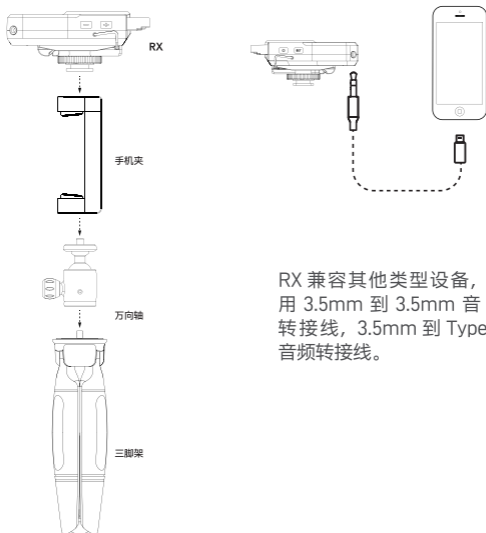

RX 兼容其他类型设备，使用 3.5mm 到 3.5mm 音频转接线，3.5mm 到 Type-C 音频转接线。

3. 在出厂之前，设备已经配对成功。如果它们没有连接或没有配对，请遵循以下步骤：

- ① 将 TX 机和 RX 机进行开机。
- ② 同时按下 RX 机的 +/- 按键，此时 RX 机的 RF 指示灯和 POWER 指示灯为同步蓝灯闪烁状态。
- ③ 同时按下 TX 机的 +/- 按键，此时 TX 机的 RF 指示灯和 POWER 指示灯为同步蓝灯闪烁状态。
- ④ 待 TX 机和 RX 机 RF 指示灯同时变为蓝色常亮时，配对成功。

## 产品规格

频段	TDMA 数字频率
调制模式	高斯频移键控
操作距离	80 米 (无障碍)
射频输出功率	10mW
拾音模式	全向型
最大声压级	110dB SPL
频率响应	50Hz~10kHz
灵敏度	-30dB
信噪比	> 75dB
电源	内置锂电池 or Type-C (直流电 5V)
使用时长	TX: 7 小时 RX: 5.5 小时
天线	PIFA 天线
音频输入接口	3.5mm TRS 接口
重量	TX/RX: 86.5g
尺寸	TX/RX: 96x40.9x23.1mm (3.8x1.6x1")
工作温度	0°C -50°C
储藏温度	- 20°C - + 55°C

## 包装清单

接收器 Blink1 RX (×1)



发射器 Blink1 TX (×2)



SR-TP2 三脚架 (×1)



MVC 手机夹 (×1)



SK-T1 云台 (×1)



全向型领夹麦克风 (×2)

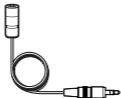

防风海绵 (×2)



领夹 (×2)



冷靴座卡板 (×1)



背夹 (×3)



SR-C8 工具箱 (×1)

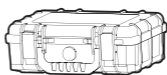

Type-C 充电线 (×3)



SR-C2001 (×1)



SR-C2000 (×1)



3.5mm TRS 音频转接线 (×1)



3.5mm TRRS 音频转接线 (×1)





Scan the QR code and follow us!  
扫描微信关注枫笛公众号

NOTE: This equipment has been tested and found to comply with the limits for a Class B digital device, pursuant to part 15 of the FCC Rules. These limits are designed to provide reasonable protection against harmful interference in a residential installation. This equipment generates uses and can radiate radio frequency energy and, if not installed and used in accordance with the instructions, may cause harmful interference to radio communications. However, there is no guarantee that interference will not occur in a particular installation. If this equipment does cause harmful interference to radio or television reception, which can be determined by turning the equipment off and on, the user is encouraged to try to correct the interference by one or more of the following measures:

- Reorient or relocate the receiving antenna.
- Increase the separation between the equipment and receiver.
- Connect the equipment into an outlet on a circuit different from that to which the receiver is connected.
- Consult the dealer or an experienced radio/TV technician for help

Changes or modifications not expressly approved by the party responsible for compliance could void the user's authority to operate the equipment.

This device complies with Part 15 of the FCC Rules. Operation is subject to the following two conditions:

- (1) this device may not cause harmful interference, and
- (2) this device must accept any interference received, including interference that may cause undesired operation.

---

**Shenzhen Jiayz Photo Industrial., Ltd**  
深圳市长丰影像器材有限公司

A16 Building, Intelligent Terminal Industrial Park of Silicon Valley  
Power, Guanlan, Longhua District, Shenzhen, China  
深圳市龙华区观澜街道大富工业区硅谷动力智能终端产业园 A16 栋



400-613-1096



[www.saramonic.com](http://www.saramonic.com)



[info@saramonic.com](mailto:info@saramonic.com)



**JIAYZ 长丰** | 深圳市长丰影像器材有限公司

产品/零件名称	Blink1 说明书	比例	1:1	版本	V00
工程图号	Blink1 说明书	物料描述	105 克铜版纸 过油 32P 骑马钉		
物料编号	1F0300400112	尺寸/用量	90x120mm 1PCS		
制图人/日期	贺磊 /2020.11.10	审核/日期			

**受控文件**  
**2020-12-29**  
**长丰影像**

修改名称	版本	变更内容	变更日期	变更担当
	V00		2020.11.10	