



UHF Wireless Microphone System

MRB-Tek Kit1

MRB-Tek Kit2

User Manual

General Introduction

MOURIV MRB-Tek is a compact multi-functional UHF wireless microphone system, delivering broadcast-quality sound to DSLRs, mirrorless and video cameras, smartphones, tablets, computers and more. It is an easy-to-use, high-quality, flexible UHF system, offering 48 frequencies to choose from to avoid wireless signal interference. The MRB-Tek system provides an inclusive, cost-effective solution for mobile journalists, vloggers, videographers, etc.

The MOURIV MRB-Tek RX is a compact camera-mountable dual-channel UHF wireless receiver. It features a 3.5mm headphone jack for audio monitoring, a high-resolution LCD color display and a 3.5mm audio output. With the supplied TRS and TRRS cables, it can work with multiple devices including cameras, mobile devices and computers. The receiver's output can be toggled between mono and stereo modes.

The MOURIV MRB-Tek TX is a compact clip-on wireless transmitter with a professional-quality built-in microphone and an easy-to-read LCD color display. It is small and light enough to clip to your shirt or collar. With its external input jack and the supplied lavalier microphone, you can also use it as a body-pack transmitter.

Available Kits

Model	In the box
MRB-Tek Kit1	1 × MRB-Tek TX
	1 × MRB-Tek RX
MRB-Tek Kit2	2 × MRB-Tek TX
	1 × MRB-Tek RX
MRB-Tek TX	1 × MRB-Tek TX

Product Structure

MRB-Tek RX: clip-on and camera-mountable receiver

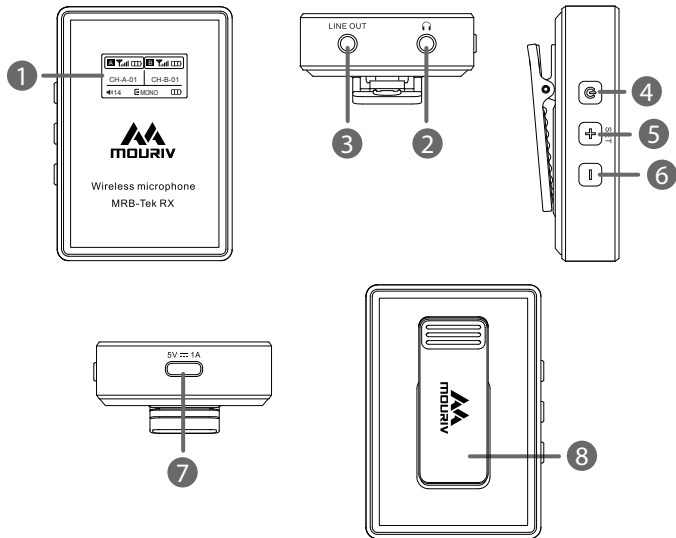

1. LCD display

- Please refer to “LCD Display Operation Guide” for more details.

2. 3.5mm headphone jack

3. LINE OUT jack

- Connect the receiver to a camera, recorder or mixer with the supplied 3.5mm TRS to TRS cable.

- Or connect the receiver to a smartphone, tablet with the supplied 3.5mm TRS to TRRS cable.

4. Power button

- Long press to turn on/off the receiver.

5. +/SET button

Function	Operation
+	Short press to select different functions or values shown on the display.
SET	Long press to enter the displayed menu. Then, long press again to confirm your option.

6. - button

- Short press to select different functions or values shown on the display.

7. USB-C charging port

8. Belt clip

MRB-Tek TX: clip-on transmitter with built-in microphone

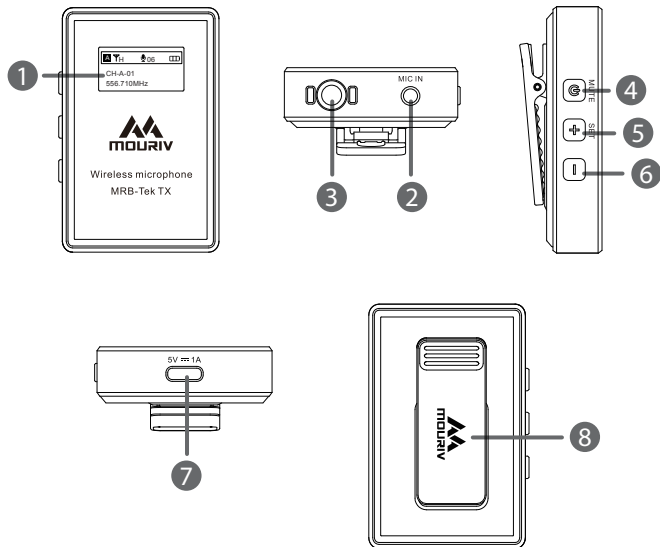

1. LCD display

- Please refer to “LCD Display Operation Guide” for more details.

2. 3.5mm MIC IN/LINE IN jack

- It can be connected to the supplied 3.5mm lavalier microphone, or other 3.5mm TRS microphones or line-in devices.

3. Built-in microphone

4. Power/Mute button

Function	Operation
Power ON/OFF	Long press
Mute ON/OFF	Short press

5. +/SET button

Function	Operation
+	Short press to select different functions or values shown on the display.
SET	Long press to enter the displayed menu. Then, long press again to confirm your option.

6. - button

- Short press to select different functions or values shown on the display.

7. USB-C charging port

8. Belt clip

LCD Display Operation Guide



MRB-Tek RX

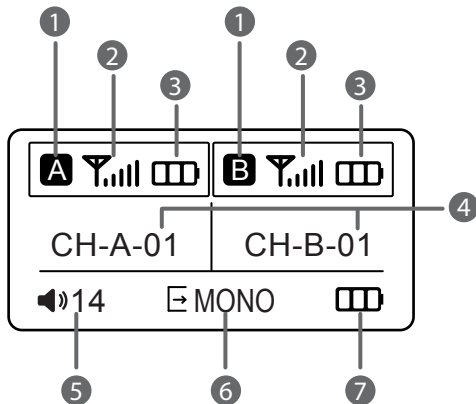

Home screen

If no operation is performed within 20 seconds on menu screens, the display will automatically return to home screen.





1. Channel group indicator

 /  Indicates the power of group A/B is turned off.

 /  Indicates the power of group A/B is turned on.

2. Signal strength indicator

 Signal is strong (Successfully paired)

 Unpaired

3. TX's battery level indicator

- Displays the TX battery level.

4. Current channel

- Displays the current channel number.

5. Output volume

6. RX's output mode

7. RX's battery level indicator

- Displays the RX battery level. Please recharge the device immediately when the indicator starts flashing.

Menu screen

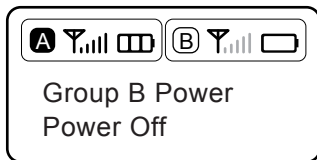

Group ON/OFF Setting

You can turn the group A/B on/off according to your needs.

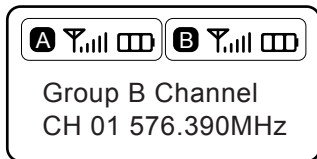
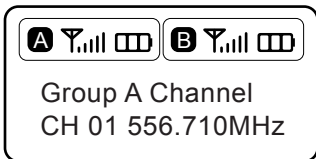

Select Channel

For details of operation, please refer to "Operation Guide".



Output Volume Setting

Set the volume of output audio within the range of 0 to 16.

Default volume is 14.

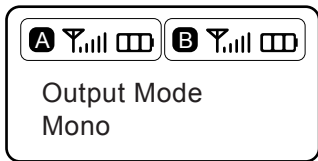

Output Mode Setting

The output mode can be set to either mono or stereo. When in mono mode, the audio from the left and right channel will be mixed. When in stereo mode, channel A's and channel B's audio output will be separated to the left and right of the stereo output.

Default is mono.



Backlight Setting

Set the backlight to always on or on for 60/30/10 seconds.

Default setting is "On".

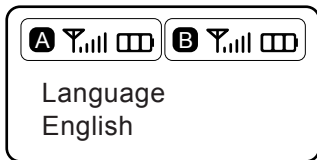

Language Setting

English or Chinese are available.

Default is English.

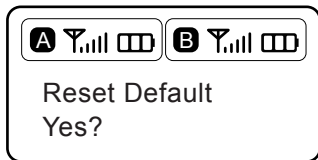

Restore Default Setting

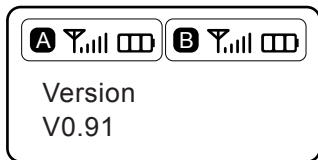

Version of the MRB-Tek RX

MRB-Tek TX

Home screen

If no operation is performed within 20 seconds on menu screens, the display will automatically return to home screen.

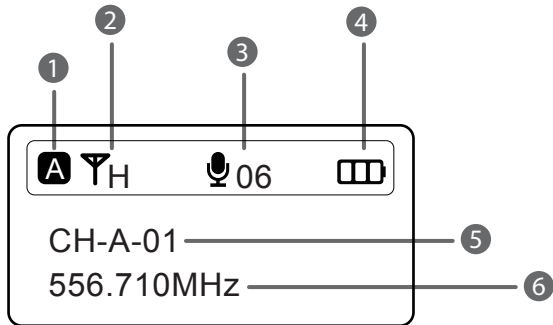

1. Channel group indicator

- Indicates the current group.

2. RF transmission power indicator

- Indicates the current transmission power level.

- For details on setting the level, please see "RF Power Setting".

3. Mic gain & Mute indicator



Mute ON



Mute OFF

4. TX's battery level indicator

- Displays the TX battery level. Please recharge the device immediately when the indicator starts flashing.

5. Channel group and channel number

- Displays the current channel group and channel number.

6. Current frequency

Menu screen

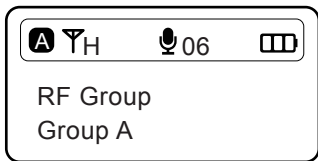

Select Group

You can choose "A" or "B" channel group. Default is "Group A".

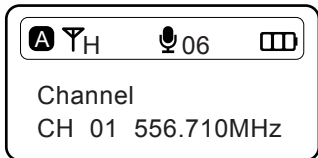

Select Channel

Long press the SET button to enter the menu. Use the "+" and "-" to select the channel you need and long press the SET button again to confirm.

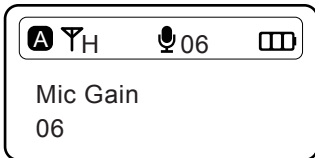

Mic Gain Setting

Adjust the microphone's input gain level (0~7). Default is "6".

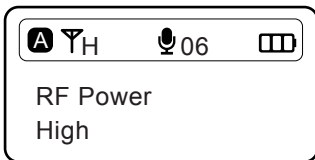

RF Power Setting

You can set the RF power to High, Middle or Low.
The default is "High".



Backlight Setting

Set the backlight to always on or on for 60/30/10 seconds.
Default setting is "On".

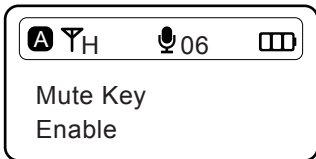

Mute Key Setting

Enable or disable mute key button function.

If "Enable" selected, short press the power/mute button will mute the microphone.

If "Disable" selected, the mute key is disabled. Short press the power/mute button won't mute the microphone.

Default is "Enable".

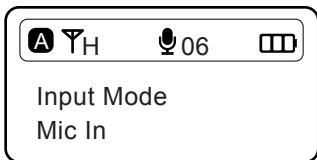

Input Mode Setting

The input mode can be selected to Mic In or Line In. When Mic In mode selected, the transmitter can be connected to the supplied lavalier microphone, or other microphones with a 3.5mm TRS output. When Line In mode selected, the transmitter can be connected to line-level devices.

Default is "Mic In".

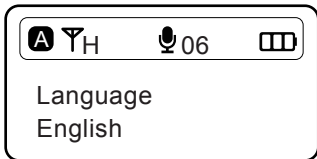

Language Setting

English or Chinese are available.

Default is English.

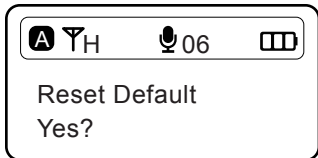

Restore Default Setting

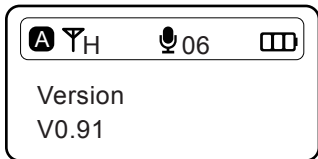

Version of the MRB-Tek TX

Operation Guide

1. Long press the power button to turn on the receiver and the transmitter.
2. Connect the receiver to a camera, recorder or mixer with the supplied 3.5mm TRS to TRS cable. Or connect the receiver to a smartphone, tablet, or computer with the supplied 3.5mm TRS to TRRS cable.

3. Set the receiver channel:

- ① Use the + or - button to display the channel setting menu on the receiver.

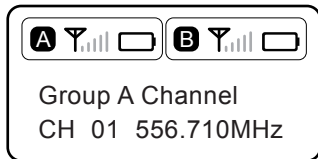

- ② Long press the SET button to select the menu.

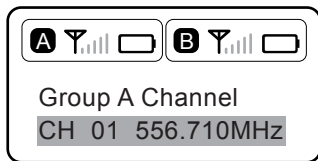

- ③ Use the + or - button to select the desired channel and confirm it by long pressing the SET button.

4. Set the transmitter channel:

① Select the same channel group as the receiver.

Use the + or – button to display the RF group setting menu on the transmitter.

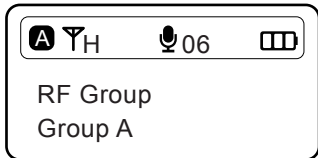

Long press the SET button to select the menu.

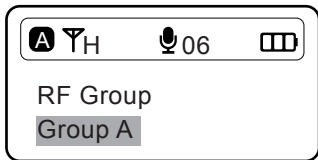

Use the + or – button to select the same group as the receiver, and confirm it by long pressing the SET button.

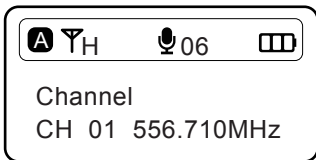

- ② Select the same channel as the receiver.
Use the + or – button to display the channel setting menu on the transmitter.



Long press the SET button to select the menu.



Use the + or – button to select the same channel as the receiver, and confirm it by long pressing the SET button.

- ③ After matching successfully, the indicator  on the receiver will change to .

5. Connect headphones to the 3.5mm headphone jack of the receiver for audio monitoring.
6. You are ready to record.

Specifications

Modulation	FM
Frequency Range	500MHz-599MHz
Operating Range	Up to 50m (without obstacle)
Signal-to-Noise Ratio	> 78dB
Antenna	FPC antenna
RF Output Power	< 10mW
Distortion	< 0.4%
Frequency Response	30Hz-18kHz
Headphone Output	3.5mm jack (Direct Monitoring)
Audio Output Connector	3.5mm jack
Audio Input Connector	3.5mm MIC IN/LINE IN jack
Battery Life	TX: Approx. 4.5 hours RX: Approx. 4.5 hours
Weight	TX: 33.3g RX: 50.5g
Dimensions	TX: 60x38.2x14.8mm RX: 66x46.2x16.5mm
Operating Temperature	0 C to 50 C
Storage Temperature	-10 C to 50 C

Package Contents

MRB-Tek Kit1 (1×MRB-Tek RX + 1×MRB-Tek TX)

- 1× MRB-Tek RX Receiver
- 1× MRB-Tek TX Transmitter
- 2× USB-C Charging Cable
- 1× Lavalier Microphone
- 1× Mic Clip for Lavalier Microphone
- 1× Foam Windscreen for Lavalier Microphone
- 1× Fur Windshield for Built-in Microphone
- 1× 3.5mm TRS to TRS Output Cable for Cameras
- 1× 3.5mm TRS to TRRS Output Cable for Smartphones

MRB-Tek Kit2 (1×MRB-Tek RX + 2×MRB-Tek TX)

- 1× MRB-Tek RX Receiver
- 2× MRB-Tek TX Transmitter
- 3× USB-C Charging Cable
- 2× Lavalier Microphone
- 2× Mic Clip for Lavalier Microphone
- 2× Foam Windscreen for Lavalier Microphone
- 2× Fur Windshield for Built-in Microphone
- 1× 3.5mm TRS to TRS Output Cable for Cameras
- 1× 3.5mm TRS to TRRS Output Cable for Smartphones

MRB-Tek TX (1×MRB-Tek TX)

- 1× MRB-Tek TX Transmitter
- 1× USB-C Charging Cable
- 1× Lavalier Microphone
- 1× Mic Clip for Lavalier Microphone
- 1× Foam Windscreen for Lavalier Microphone
- 1× Fur Windshield for Built-in Microphone

FCC Warning

This device complies with part 15 of the FCC Rules. Operation is subject to the following two conditions:(1) This device may not cause harmful interference, and (2) this device must accept any interference received, including interference that may cause undesired operation.

Any Changes or modifications not expressly approved by the party responsible for compliance could void the user's authority to operate the equipment.

This equipment has been tested and found to comply with the limits for a Class B digital device, pursuant to part 15 of the FCC Rules. These limits are designed to provide reasonable protection against harmful interference in a residential installation. This equipment generates uses and can radiate radio frequency energy and, if not installed and used in accordance with the instructions, may cause harmful interference to radio communications. However, there is no guarantee that interference will not occur in a particular installation. If this equipment does cause harmful interference to radio or television reception, which can be determined by turning the equipment off and on, the user is encouraged to try to correct the interference by one or more of the following measures:

- Reorient or relocate the receiving antenna.
- Increase the separation between the equipment and receiver.
- Connect the equipment into an outlet on a circuit different from that to which the receiver is connected.
- Consult the dealer or an experienced radio/TV technician for help.

The device has been evaluated to meet general RF exposure requirement. The device can be used in portable exposure condition without restriction.

FCC RF exposure statement:

shenzhen Qianzhao shang mao you xian gong si
Email: support@mouriv.com
www.mouriv.com