



©<https://www.eldmandate.biz>



Dash Cam Manual

Model EM10

Table of Contents

Dash Cam Diagram	3
Installation Guide	4
Features	6
Basic Functions of the Dash Cam	8
Power On/Off Turn On/Off screen Reset	
UI of the Dash Cam	9
Camera DVR	11
FM Transmitter	12
App List	13
Camera Playback	14
Settings	15
Product Specifications	18

Dash Cam Diagram

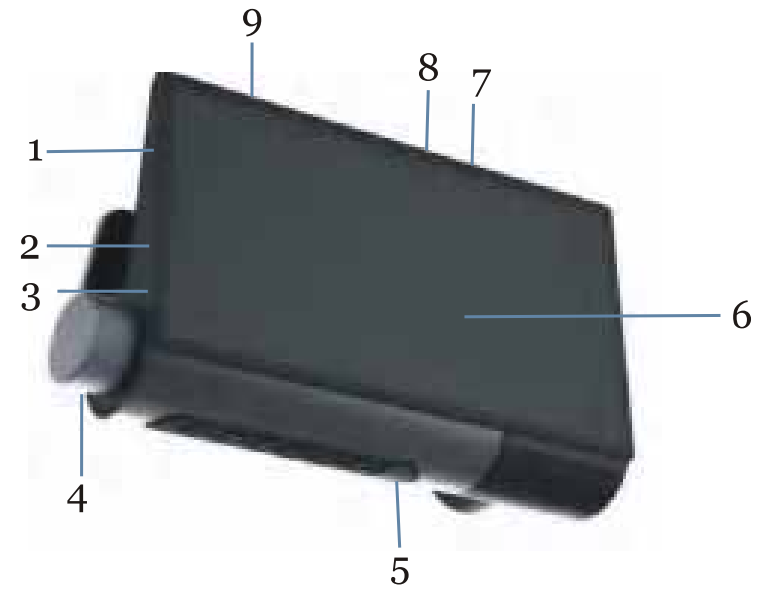

-
- | | | |
|------------------|-----------------|------------|
| 1: Sim card port | 2: SD card port | 3: Restart |
|------------------|-----------------|------------|
-
- | | | |
|-----------------------|-----------------|-----------------|
| 4: Angle Tighten Knob | 5: Power button | 6: Touch screen |
|-----------------------|-----------------|-----------------|
-
- | | | |
|-----------------------|-------------------|----------------|
| 7: Second camera port | 8: USB connection | 9: GPS antenna |
|-----------------------|-------------------|----------------|
-

Installation Guide

1. Turn off the engine of the vehicle
2. Unit comes with a 64GB SD Card which will be already in the SD card slot

[Note] If the user needs to replace this SD card, please take out the current SD card and insert new card into the SD card port. Please use a high-speed SD card (Class 10 or higher). The storage should be 2GB or more, and up to 128 GB

3. Clean the windshield glass from inside the truck with an alcohol wipe or the cleaning rag provided in the package
 4. Remove the Plastic Film over the 3M sticker, and place the Dash Cam near the rear-view mirror of the truck. Hold for 5 seconds to keep in place
 5. Connect the ACC cable with the Automotive Fuse Box
- [Note] When wiring, the charging extension line can be laid along the edge of the car windshield
- [Optional] Dash Cam can also be connected with the cigarette lighter charger to the USB port of the dash cam with a

charging extension cable. This is Not Recommended. Using it this way could lead to permanent damage to the unit.

6. Adjust the lens position to ensure that the lens is level with the ground
7. Tighten the dash cam position by using the Angle tighten Knob (4 in diagram above) to get the desired angle of the dash cam
8. Install the second camera on the rear of the vehicle, side of the vehicle, or facing the driver. The wiring can be laid along the roof of the vehicle if needed. After installation, connect the plug to the second camera port of the Dash Cam

Features

Automatic Locked Files

A file is automatically locked and sent to the portal if the collision sensitivity is met. The upload will happen on the background as long as the camera is powered on. Even if powered off- the moment it gets power the locked file will start uploading again. Each minute of locked file video is approximately 100MB and can take the appropriate time to upload.

All locked files will be automatically uploaded on secure servers which can be accessed from anywhere in the world for over a period of 2 years.

Fleet Management Functionality

The GPS antenna of the dash cam can be used to do near live tracking of the truck. Ensure that the GPS Antenna is facing upwards. Full Telematics on near real time basis will be available to fleet manager or back office team. This includes geofencing, custom alerts, reports, full breadcrumb, and location sharing. Additionally, the dash cam can provide video of hard breaking, hard acceleration, or any collision.

Both features above require a monthly subscription

Loop Recording

Once the memory of the dash cam has been reached new video is automatically saved over the oldest video files.

1080P Front Camera & AHD for Second Camera

High quality video footage saved.

Standalone 4G LTE Dash Cam

This dash cam does not require any use of smart phone in order to view video files. All files can be viewed and locked directly on the dash cam.

Google Maps

Dash Cam has inbuilt google maps which can be used for navigation purposes. Our sim card is required for this feature.

Other features are detailed in this manual.

Basic Functions of the dash cam

Power on/off function

A: In the powered-on state, long press the power button and hold for 3 seconds, the unit will automatically save the current video file and shut down;

B: In the power-off state, long press the power button and hold for 3 seconds for turning on the unit.

Turn on/off the screen

Short press the power button, and the unit will enter HUD mode with the screen off. Short press the power button again to light on the screen. If short pressed the dash cam will continue to take video files even if the screen is off.







Restart button



Short press the restart button to restart the dash cam.

The UI of the dash cam



The dash cam is touchscreen. Use a finger for navigation and clicking. The above UI is the home screen. The items on the home screen are described further below:

	Enters the recording interface which shows what is currently being recorded by the dash cam
	Lists out the current videos that are available on the dash cam
	Enters Radio FM
	Opens Google maps.
	Opens Music.
	Enters into the full list of apps that are downloaded on the dash cam.

 means the video is being recorded with a voice recording, while clicking on it again toggles it to  which means the video is not doing a voice recording.

 Takes the user to the settings below:



 to go back to the home page

 to go back to the previous page

Camera DVR:



The UI above is what is seen when clicking on the Camera DVR app. **Red Dot** on the top left indicates that the video is being recorded. The **Preview icon** is to switch between viewing the front camera and the second camera.

Clicking on the **Camera Icon** will take a picture.

Clicking on the **Voice Recorder** will either toggle sound recording on or off.

Press the **Setting button** to be taken to the setting screen.

Note- setting screen is not supported if it is on video recording mode.

The **Back Icon** will take the user back one screen.

FM transmitter



After clicking on the FM function, the frequency can be adjusted manually. (note - turn on the radio first and adjust to an empty frequency band without sound)

Turn on the radio on the truck and adjust to the corresponding frequency, then the FM function can be used normally.

App List

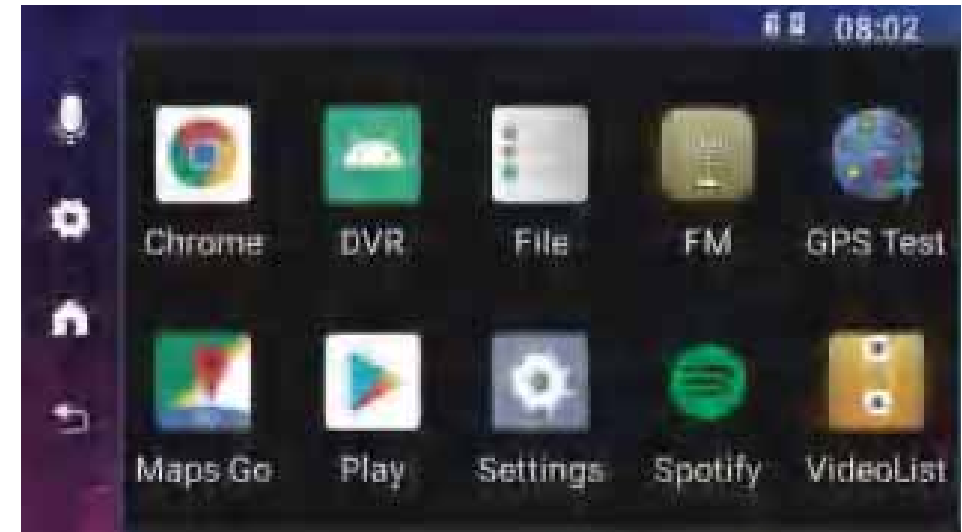

The app list stores all the apps that are downloaded by the user on the dash cam, along with a pre-installed set of apps. To add apps please go into the play store (labeled “Play”) and input your google account to download a new app. Apps cannot be deleted once downloaded. Only apps that are downloaded through the playstore are automatically updated.

Camera Playback

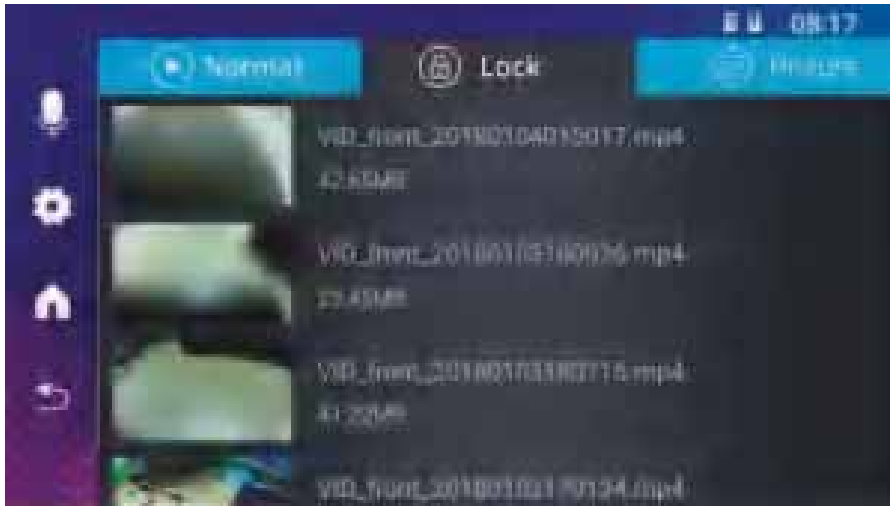

Long press the video for choosing “Lock/delete/Cancel”. If moved to the lock tab this video will stay on the dash cam at all times. However, it will not be uploaded to the back-end portal. Only locked files as described in the Features section get automatically uploaded to the back-end portal.

Settings

Clicking on the setting icon, will enter the view as shown in section V. The view below is for more settings:

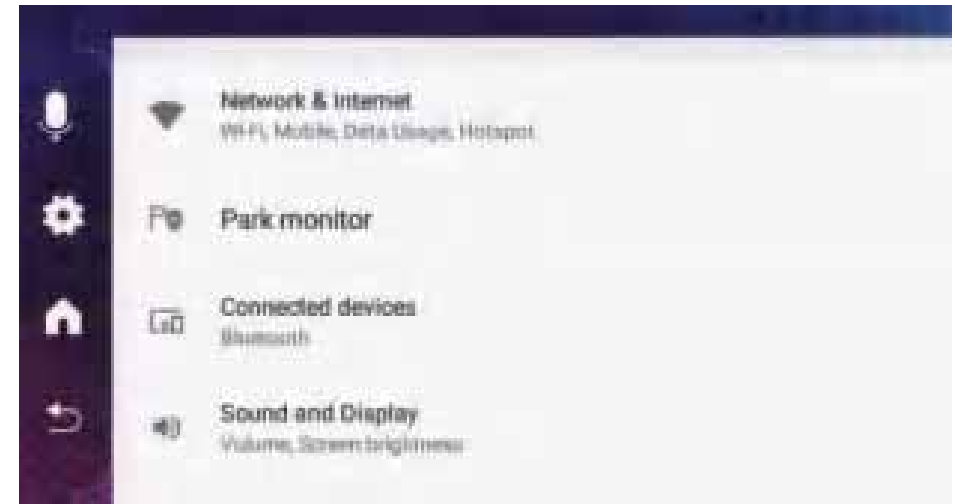

Network & Internet: When clicking on the open/off button in the Network & Internet, a user can open the WiFi function. The system automatically scans nearby WiFi signals and lists the searched wireless routers. Once clicking on the searched wireless router name, a setting window will pop up. Please follow the prompts to complete the WiFi network link. Some encrypted networks need to enter a valid password. Please enter the correct password and click "Connect" to the network.

Parking monitor: The parking monitor function is triggered by the G sensor in the unit. When park mode is

Off, the G sensor and CPU will not work. When it is On, the unit will be switched to Park mode after shutting off. The device will enter sleep mode after parking, and if there is a shake during the parking period, the device will automatically wake up and record for one minute (the screen will not light up) and then continue to be in sleep mode after that. **Note-** Parking Monitor functionality may not work for certain truck models depending on how the dash cam is powered to the engine. Parking monitor will not work if the dash cam is powered using the cigarette lighter.

Connected device: User can turn on/off a Bluetooth connection if needed.

Sound and Display: For adjusting the Volume of Music of the dash cam and the brightness level of the screen.

Storage: The information about the storage of the dash cam and the SD card.

Google: Information about the users android services and preferences.

System ->

Language & input: Select for choosing a different language

Date & time: It is for adjusting day and time. There are 3

ways for the user to choosing the way to adjust the correct time, use network-provided time, use GPS-provided time and automatic time zone

Change Automatic Sensitivity

Go to DVR Camera. Then click on the settings icon. From here user can select the sensitivity of the collision detection.

Product Specifications

Processor & Memory characteristics	
Processor type	Quad-core
DDR	2 GB
eMMC Flash	16 GB
Functional characteristics	
Display	MIPI 4.39 inch screen
Display resolution	640 * 360 pixels
External I/O port	1 USB 2.0 (power supply: DC5V / 3A)
	1 SIM card slot, support MICRO SIM card
	Expansion memory card: TF card/SD card capacity supports up to 128 GB
	1 GPS feeder interface
	1 analog rear camera (2.5MM 4-segment headphone holder) interface, compatible with auto reversing function
Speaker	Built-in (8ohm / 1.5W)
MIC	Built-in -40db ± 2db
Pull back camera	Support AHD (high-definition camera) cable length: 5.5 meters or shorter cable length available if needed
Full screen touch	Full capacitive screen
WIFI	2.4G 802.11b/g/n
Band	Band: 2G: B2/B5 3G: B1/B2/B4/B5 4G: B2/B4/B5/B7/B12/B17
BT	BLE 4.0 supports master and slave devices
GPS navigation	Dual Mode Google Maps + GPS
FM transmission	Support 88-108MHz
Photograph	Support
Front camera	1080P
Camera angle	140° wide angle
Video format	MP4
Image Format	JPEG
Storage compression method	Front Cam H.264

Software Support	
Operating system	Android 8.1
Language support	Multi-language
G-SENSOR	X/Y/Z Axis - Triaxial
Loop recording	Support, seamless recording
recording function	Support
Time watermark	Support
Front camera video quality	Supports up to 1920 x 1080 (1080P 25 f/s) or 1280 x 720 (720p 25 f/s)
Second camera video quality	AHD Camera

© Eld Mandate Biz. All rights reserved

FCC STATEMENT :

This device complies with Part 15 of the FCC Rules. Operation is subject to the following two conditions:

This device may not cause harmful interference, and

This device must accept any interference received, including interference that may cause undesired operation.

Warning: Changes or modifications not expressly approved by the party responsible for compliance could void the user's authority to operate the equipment.

NOTE: This equipment has been tested and found to comply with the limits for a Class B digital device, pursuant to Part 15 of the FCC Rules. These limits are designed to provide reasonable protection against harmful interference in a residential installation.

This equipment generates uses and can radiate radio frequency energy and, if not installed and used in accordance with the instructions, may cause harmful interference to radio communications. However, there is no guarantee that interference will not occur in a particular installation. If this equipment does cause harmful interference to radio or television reception, which can be determined by turning the equipment off and on, the user is encouraged to try to correct the interference by one or more of the following measures:

Reorient or relocate the receiving antenna.

Increase the separation between the equipment and receiver.

Connect the equipment into an outlet on a circuit different from that to which the receiver is connected.

Consult the dealer or an experienced radio/TV technician for help.

FCC Radiation Exposure Statement:

This equipment complies with FCC radiation exposure limits set forth for an uncontrolled environment. This equipment should be installed and operated with minimum distance 20cm between the radiator & your body.