



TEST REPORT

FCC Part 15 Subpart C 15.231

Report Reference No. : CTL1809278071-WF

Compiled by:
(position+printed name+signature)

Happy Guo
(File administrators)

Happy Guo

Tested by:
(position+printed name+signature)

Nice Nong
(Test Engineer)

Nice Nong

Approved by:
(position+printed name+signature)

Ivan Xie
(Manager)

Ivan Xie

Product Name : WEATHER STATION

Model/Type reference : DM8835

List Model(s)..... : N/A

Trade Mark..... : N/A

FCC ID..... : 2ARMP-DM8835

Applicant's name : **Digi-Max Technology Limited**

Address of applicant : Room 708, Building 3, XIN YUAN, Jinshan Industrial District,
Fuzhou, Fujian, China

Test Firm..... : **Shenzhen CTL Testing Technology Co., Ltd.**

Address of Test Firm : Floor 1-A, Baisha Technology Park, No.3011, Shahehexi Road,
Nanshan District, Shenzhen, China 518055

Test specification..... :

Standard : **FCC Part 15 Subpart C 15.231**

TRF Originator : Shenzhen CTL Testing Technology Co., Ltd.

Master TRF..... : Dated 2011-01

Date of Receipt..... : Sep. 28, 2018

Date of Test Date..... : Sep. 28, 2018 –Oct. 22, 2018

Data of Issue..... : Oct. 23, 2018

Result..... : Pass

Shenzhen CTL Testing Technology Co., Ltd. All rights reserved.

This publication may be reproduced in whole or in part for non-commercial purposes as long as the Shenzhen CTL Testing Technology Co., Ltd. is acknowledged as copyright owner and source of the material. Shenzhen CTL Testing Technology Co., Ltd. takes no responsibility for and will not assume liability for damages resulting from the reader's interpretation of the reproduced material due to its placement and context.

TEST REPORT

Test Report No. :	CTL1809278071-WF	Oct. 23, 2018
		Date of issue

Equipment under Test : WEATHER STATION

Model /Type : DM8835

Listed Models : N/A

Applicant : **Digi-Max Technology Limited**

Address : Room 708, Building 3, XIN YUAN, Jinshan Industrial District, Fuzhou, Fujian, China

Manufacturer : **PUTIAN JOKO ELECTRONIC CO.,LTD**

Address : NO.4099, GUOHUAN EAST ROAD, SHIXI VILLAGE, JIANGKOU TOWN, HANJIANG DISCTRICT, PUTIAN CITY, CHINA

Test result	Pass *
--------------------	---------------

* In the configuration tested, the EUT complied with the standards specified page 5.

The test report merely corresponds to the test sample.

It is not permitted to copy extracts of these test result without the written permission of the test laboratory.

**** Modified History ****

Version	Description	Issued Data	Report No.	Remark
Version 1.0	Initial Test Report Release	2018-10-23	CTL1809278071-WF	Tracy Qi



Table of Contents

Page

- 1. SUMMARY 5**
 - 1.1. TEST STANDARDS.....5
 - 1.2. TEST DESCRIPTION.....5
 - 1.3. TEST FACILITY6
 - 1.4. STATEMENT OF THE MEASUREMENT UNCERTAINTY.....6

- 2. GENERAL INFORMATION 7**
 - 2.1. ENVIRONMENTAL CONDITIONS7
 - 2.2. GENERAL DESCRIPTION OF EUT7
 - 2.3. EQUIPMENTS USED DURING THE TEST7
 - 2.4. RELATED SUBMITTAL(S) / GRANT (S).....8
 - 2.5. MODIFICATIONS.....8

- 3. TEST CONDITIONS AND RESULTS 9**
 - 3.1. CONDUCTED EMISSION (AC MAIN)9
 - 3.2. RADIATED EMISSION10
 - 3.3. 20dB BANDWIDTH.....15
 - 3.4. TRANSMISSION TIME16
 - 3.5. ANTENNA REQUIREMENT.....17

- 4. TEST SETUP PHOTOS OF THE EUT 18**

- 5. EXTERNAL AND INTERNAL PHOTOS OF THE EUT 19**

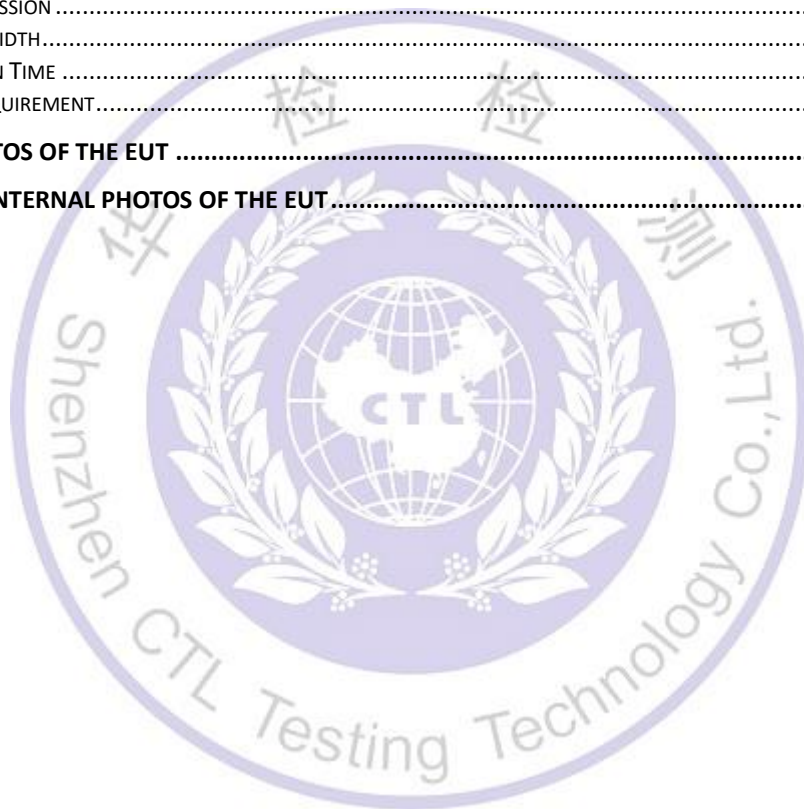

1. SUMMARY

1.1. Test Standards

The tests were performed according to following standards:

FCC Rules Part 15.231: Periodic operation in the band 40.66-40.70 MHz and above 70 MHz.

ANSI C63.10:2013 : American National Standard for Testing Unlicensed Wireless Devices

ANSI C63.4: 2014: –American National Standard for Methods of Measurement of Radio-Noise Emissions from Low-Voltage Electrical and Electronic Equipment in the Range of 9 kHz to 40GHz
Range of 9 kHz to 40GHz

1.2. Test Description

FCC and IC Requirements		
FCC Part 15.207	Conducted Emission	N/A
FCC Part 15.231(e)	Transmission Time	PASS
FCC Part 15.231(e)	Electric Field Strength of Fundamental Emission	PASS
FCC Part 15.205 & 15.209 & 15.231(e)	Electric Field Strength of Spurious Emission	PASS
FCC Part 15.231(c)	-20dB bandwidth	PASS

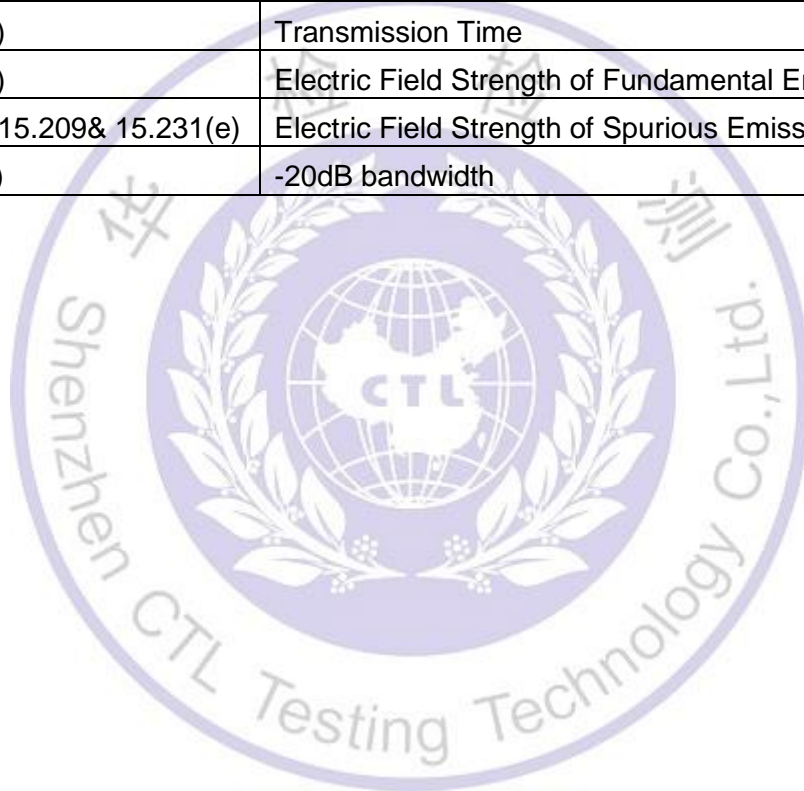

1.3. Test Facility

1.3.1 Address of the test laboratory

Shenzhen CTL Testing Technology Co., Ltd.

Floor 1-A, Baisha Technology Park, No. 3011, Shahexi Road, Nanshan, Shenzhen 518055 China

The 3m-Semi anechoic test site fulfils CISPR 16-1-4 according to ANSI C63.4:2014 and CISPR 16-1-4:2010 SVSWR requirement for radiated emission above 1GHz.

1.3.2 Laboratory accreditation

The test facility is recognized, certified, or accredited by the following organizations:

IC Registration No.: 9618B

The 3m alternate test site of Shenzhen CTL Testing Technology Co., Ltd. EMC Laboratory has been registered by Certification and Engineer Bureau of Industry Canada for the performance of with Registration No.: 9618B on November 13, 2013.

FCC-Registration No.: 399832

Shenzhen CTL Testing Technology Co., Ltd. EMC Laboratory has been registered and fully described in a report filed with the (FCC) Federal Communications Commission. The acceptance letter from the FCC is maintained in our files. Registration 399832, December 08, 2017.

1.4. Statement of the measurement uncertainty

The data and results referenced in this document are true and accurate. The reader is cautioned that there may be errors within the calibration limits of the equipment and facilities. The measurement uncertainty was calculated for all measurements listed in this test report acc. to CISPR 16 - 4 "Specification for radio disturbance and immunity measuring apparatus and methods – Part 4: Uncertainty in EMC Measurements" and is documented in the Shenzhen CTL Testing Technology Co., Ltd. quality system acc. to DIN EN ISO/IEC 17025. Furthermore, component and process variability of devices similar to that tested may result in additional deviation. The manufacturer has the sole responsibility of continued compliance of the device.

Hereafter the best measurement capability for CTL laboratory is reported:

Test	Measurement Uncertainty	Notes
Transmitter power conducted	±0.57 dB	(1)
Transmitter power Radiated	±2.20 dB	(1)
Conducted spurious emission 9KHz-40 GHz	±2.20 dB	(1)
Occupied Bandwidth	±0.01ppm	(1)
Radiated Emission 30~1000MHz	±4.10dB	(1)
Radiated Emission Above 1GHz	±4.32dB	(1)
Conducted Disturbance0.15~30MHz	±3.20dB	(1)

- (1) This uncertainty represents an expanded uncertainty expressed at approximately the 95% confidence level using a coverage factor of k=2.

2. GENERAL INFORMATION

2.1. Environmental conditions

During the measurement the environmental conditions were within the listed ranges:

Normal Temperature:	25°C
Relative Humidity:	55 %
Air Pressure:	101 kPa

2.2. General Description of EUT

Product Name:	WEATHER STATION
Model/Type reference:	DM8835
Power supply:	DC 3V from battery
Modulation:	ASK
Operation frequency:	433.92MHz
Channel number:	1
Antenna type:	PCB antenna
Antenna gain:	0dBi

Note: For more details, please refer to the user's manual of the EUT.

2.3. Equipments Used during the Test

Test Equipment	Manufacturer	Model No.	Serial No.	Calibration Date recent	Calibration Due Date
LISN	R&S	ENV216	3560.6550.12	2018/06/01	2019/05/31
LISN	R&S	ESH2-Z5	860014/010	2018/06/01	2019/05/31
Power Meter	Agilent	U2531A	TW53323507	2018/06/01	2019/05/31
Power Sensor	Agilent	U2021XA	MY5365004	2018/05/20	2019/05/19
EMI Test Receiver	R&S	ESCI	103710	2018/06/01	2019/05/31
Spectrum Analyzer	Agilent	E4407B	MY41440676	2018/05/20	2019/05/19
Spectrum Analyzer	Agilent	N9020	US46220290	2018/01/16	2019/01/15
Controller	EM Electronics	Controller EM 1000	N/A	2018/05/20	2019/05/19
Active Loop Antenna	Daze	ZN30900A	N/A	2018/05/18	2019/05/17
Bilog Antenna	Sunol Sciences Corp.	JB1	A061713	2018/06/01	2019/05/31
Horn Antenna	Sunol Sciences Corp.	DRH-118	A062013	2018/05/18	2019/05/17
Horn Antenna	SCHWARZBACK	BBHA 9170	BBHA9170184	2018/05/18	2019/05/17
Amplifier	Agilent	8349B	3008A02306	2018/05/18	2019/05/17
Amplifier	Agilent	8447D	2944A10176	2018/05/18	2019/05/17
Temperature/Humidity Meter	Gangxing	CTH-608	02	2018/05/19	2019/05/18
High-Pass Filter	K&L	9SH10-2700/X12750-O/O	N/A	2018/05/19	2019/05/18
High-Pass Filter	K&L	41H10-1375/U12750-O/O	N/A	2018/05/19	2019/05/18
Coaxial Cables	HUBER+SUHNER	SUCOFLEX 104PEA-10M	10m	2018/06/01	2019/05/31

Coaxial Cables	HUBER+SUHNER	SUCOFLEX 104PEA-3M	3m	2018/06/01	2019/05/31
Coaxial Cables	HUBER+SUHNER	SUCOFLEX 104PEA-3M	3m	2018/06/01	2019/05/31
RF Cable	Megalon	RF-A303	N/A	2018/06/01	2019/05/31
EMI Test Software	R&S	ES-K1	V1.7.1	2018/06/01	2019/05/31
EMI Test Software	AUDIX	E3	V6.0	2018/06/01	2019/05/31

The calibration interval was one year

2.4. Related Submittal(s) / Grant (s)

This submittal(s) (test report) is intended to comply with Section 15.231 of the FCC Part 15, Subpart C Rules.

2.5. Modifications

No modifications were implemented to meet testing criteria.



3. TEST CONDITIONS AND RESULTS

3.1. Conducted Emission (AC Main)

LIMIT

FCC CFR Title 47 Part 15 Subpart C Section 15.207

Frequency range (MHz)	Limit (dBuV)	
	Quasi-peak	Average
0.15-0.5	66 to 56*	56 to 46*
0.5-5	56	46
5-30	60	50

* Decreases with the logarithm of the frequency.

TEST CONFIGURATION

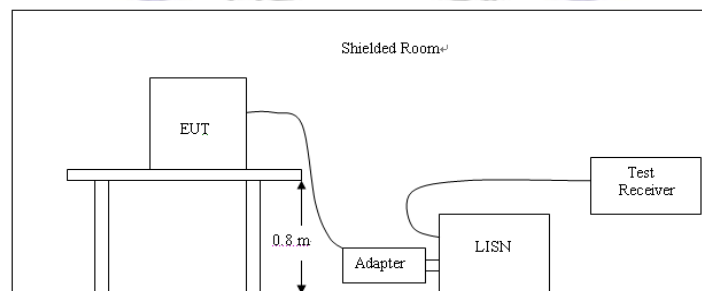

TEST PROCEDURE

1. The equipment was set up as per the test configuration to simulate typical actual usage per the user's manual. The EUT is a flood stand system; a wooden table with a height of 0.1 meters is used and is placed on the ground plane as per ANSI C63.10-2013.
2. Support equipment, if needed, was placed as per ANSI C63.10-2013
3. All I/O cables were positioned to simulate typical actual usage as per ANSI C63.10-2013
4. If a EUT received DC power from the USB Port of Notebook PC, the PC's adapter received AC120V/60Hz power through a Line Impedance Stabilization Network (LISN) which supplied power source and was grounded to the ground plane.
5. All support equipments received AC power from a second LISN, if any.
6. The EUT test program was started. Emissions were measured on each current carrying line of the EUT using a spectrum Analyzer / Receiver connected to the LISN powering the EUT. The LISN has two monitoring points: Line 1 (Hot Side) and Line 2 (Neutral Side). Two scans were taken: one with Line 1 connected to Analyzer / Receiver and Line 2 connected to a 50 ohm load; the second scan had Line 1 connected to a 50 ohm load and Line 2 connected to the Analyzer / Receiver.
7. Analyzer / Receiver scanned from 150 KHz to 30MHz for emissions in each of the test modes.
8. During the above scans, the emissions were maximized by cable manipulation.

TEST RESULTS

Not applicable for device which is battery supply.

3.2. Radiated Emission

Limit

For intentional device, according to 15.209(a) the general requirement of field strength of radiated emission from intentional radiators at a distance of 3 meters shall not exceed the following table.

Frequency (MHz)	Distance (Meters)	Radiated (dB μ V/m)	Radiated (μ V/m)
0.009-0.49	3	$20\log(2400/F(\text{KHz}))+40\log(300/3)$	$2400/F(\text{KHz})$
0.49-1.705	3	$20\log(24000/F(\text{KHz}))+40\log(30/3)$	$24000/F(\text{KHz})$
1.705-30	3	$20\log(30)+40\log(30/3)$	30
30-88	3	40.0	100
88-216	3	43.5	150
216-960	3	46.0	200
Above 960	3	54.0	500

In addition to the provisions of 15.231(e) and RSS 210-A.1.4, the field strength of emissions from intentional radiators operated under this section shall not exceed the following:

Fundamental frequency (MHz)	Field strength of fundamental (microvolts/meter)	Field strength of spurious emission (microvolts/meter)
40.66-40.70	1,000	100
70-130	500	50
130-174	500 to 1,500 ¹	50 to 150 ¹
174-260	1,500	150
260-470	1,500 to 5,000 ¹	150 to 500 ¹
Above 470	5,000	500

[Where F is the frequency in MHz, the formulas for calculating the maximum permitted fundamental field strengths are as follows: for the band 260-470 MHz, μ V/m at 3 meters = $(16.67 \times f) - 2833.33$. The maximum permitted unwanted emission level is 20 dB below the maximum permitted fundamental level.]

TEST CONFIGURATION

(A) Radiated Emission Test Set-Up, Frequency Below 30MHz

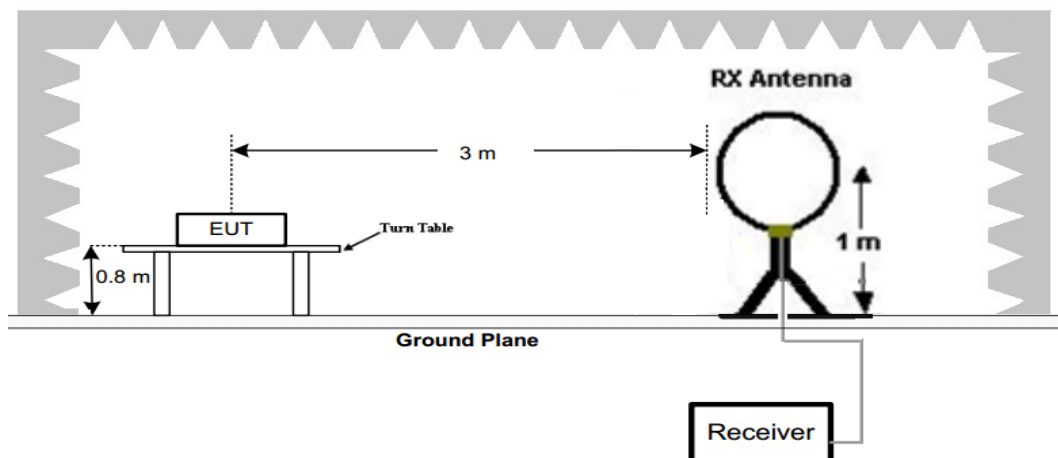

(B) Radiated Emission Test Set-Up, Frequency below 1000MHz

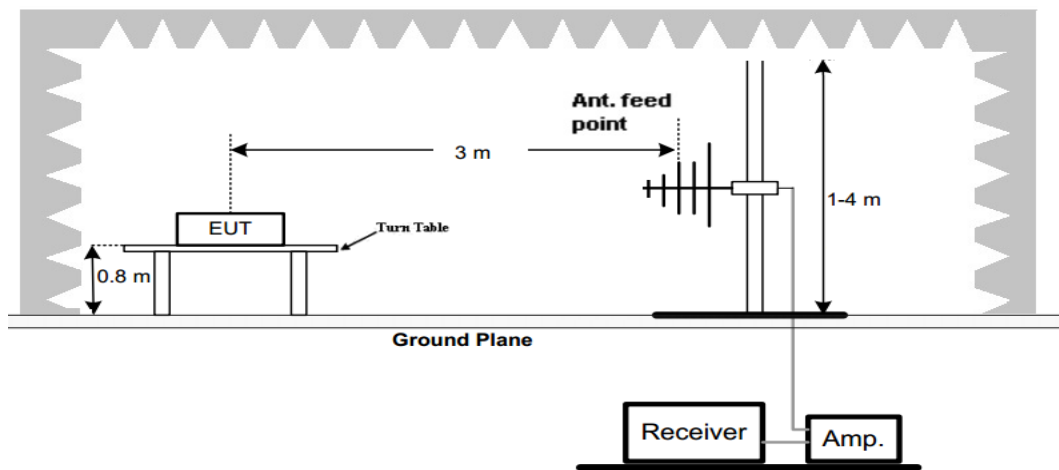

(C) Radiated Emission Test Set-Up, Frequency above 1000MHz

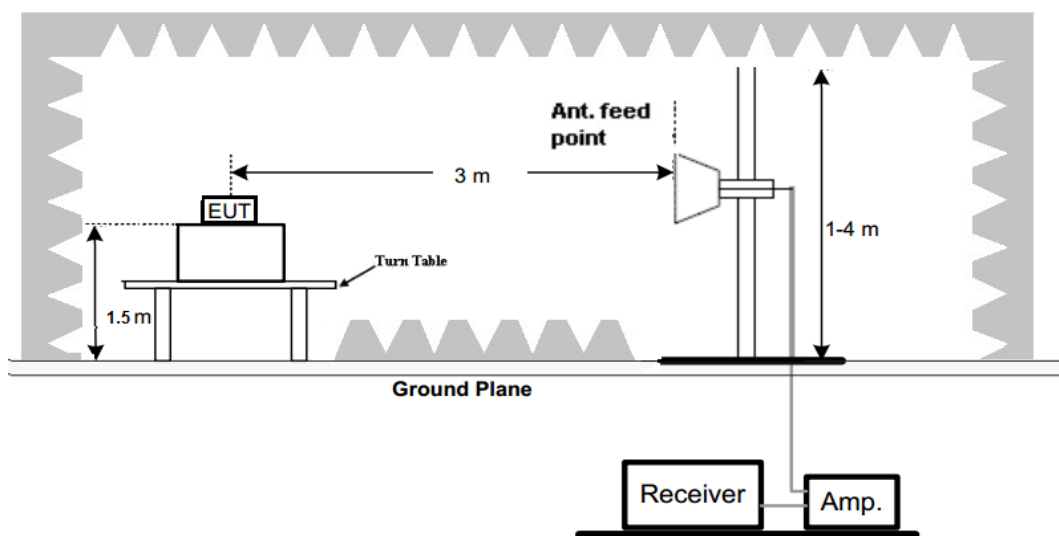

Test Procedure

1. Below 1GHz measurement the EUT is placed on a turntable which is 0.8m above ground plane, and above 1GHz measurement EUT was placed on a low permittivity and low loss tangent turn table which is 1.5m above ground plane.
2. Maximum procedure was performed by raising the receiving antenna from 1m to 4m and rotating the turn table from 0° to 360° to acquire the highest emissions from EUT
3. And also, each emission was to be maximized by changing the polarization of receiving antenna both horizontal and vertical.
4. Repeat above procedures until all frequency measurements have been completed.

TEST RESULTS

The emissions from 30MHz to 5GHz are measured peak and average level, below 1 GHz measured QP level, detailed test data please see below. Besides, we tested 3 directions and recorded the worst data.

Emission Styles	Frequency (MHz)	Reading (dBuV/m)	Limit (dBuV/m)	Margin (dB)	Detector	Direction (H/V)
Fundamental	433.92	76.30	92.87	16.57	PK	H
Spurious	435.86	38.10	72.87	34.77	PK	H
Harmonics	867.84	52.64	72.87	20.23	PK	H
Harmonics	1735.68	52.36	72.87	20.51	PK	H
--	--	--	--	--	--	--
Fundamental	433.92	79.50	92.87	13.37	PK	V
Spurious	435.86	37.10	72.87	35.77	PK	V
Harmonics	867.84	50.58	72.87	22.29	PK	V
Harmonics	1735.68	49.40	72.87	23.47	PK	V
--	--	--	--	--	--	--

Emission Styles	Frequency (MHz)	PK Level (dBuV/m)	AV Factor (dB/m)	AV Level (dBuV/m)	Limit (dBuV/m)	Margin (dB)	Direction (H/V)
Fundamental	433.92	76.30	-16.19	60.11	72.87	12.76	H
Spurious	435.86	38.10	-16.19	21.91	52.87	30.96	H
Harmonics	867.84	52.64	-16.19	36.45	52.87	16.42	H
Harmonics	1735.68	52.36	-16.19	36.17	52.87	16.70	H
--	--	--	--	--	--	--	--
Fundamental	433.92	79.50	-16.19	63.31	72.87	9.56	V
Spurious	435.86	37.10	-16.19	20.91	52.87	31.96	V
Harmonics	867.84	50.58	-16.19	34.39	52.87	18.48	V
Harmonics	1735.68	49.40	-16.19	33.21	52.87	19.66	V
--	--	--	--	--	--	--	--

Note:

- AV Level (dBuV/m)= PK Level (dBuV/m)+ AV Factor(dB)
- In a transmit cycle 110.5ms period found 0.5ms burst 33pcs, the Duty Cycle can calculate as below:

$$\text{Duty Cycle} = (0.5 * 31) / 100.0 = 0.155$$
 (Note: According to C63.10, if the transmit cycle period longer than 100ms, then 100ms is used calculation.)

$$\text{AV Factor} = 20 * \log(\text{Duty Cycle}) = 20 * \log(0.155) = -16.19$$
 (The plot of Duty Cycle See the follow page)

Duty cycle plots

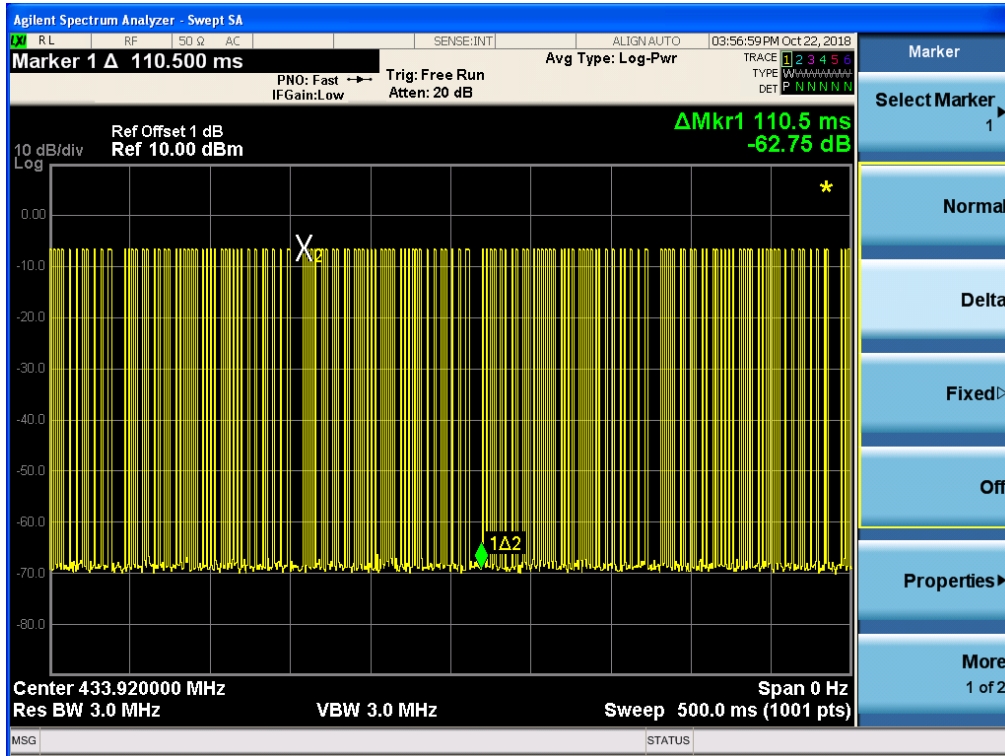

(Transmit cycle 110.5ms)
(Total Bursts in a transmit cycle 33pcs)

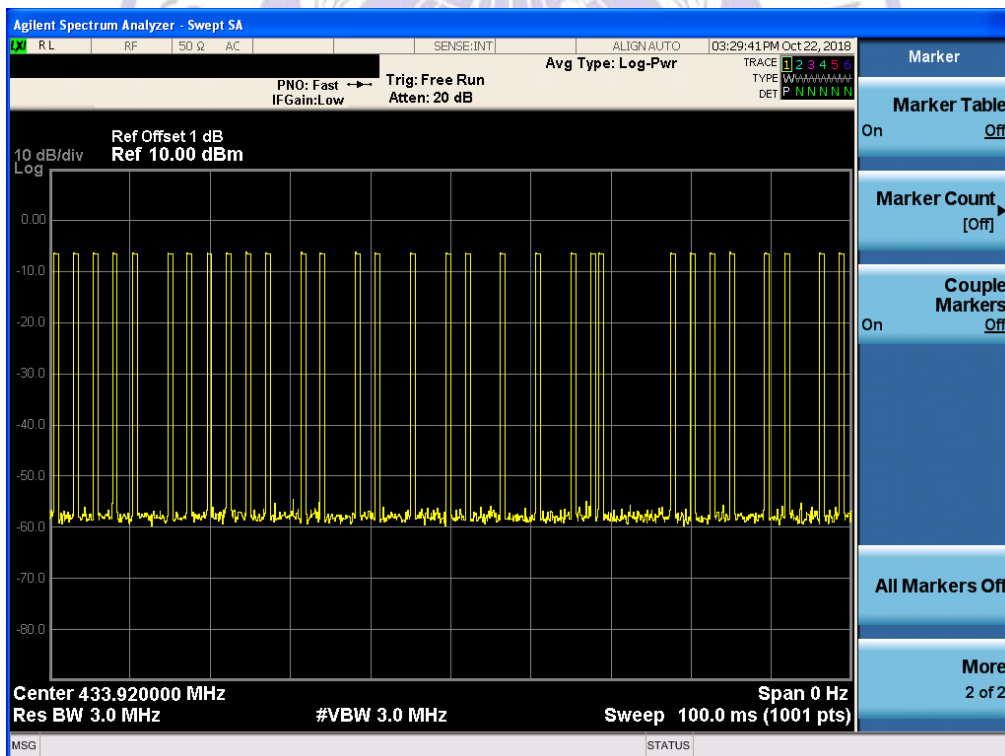

(31pcs Bursts in 100ms)

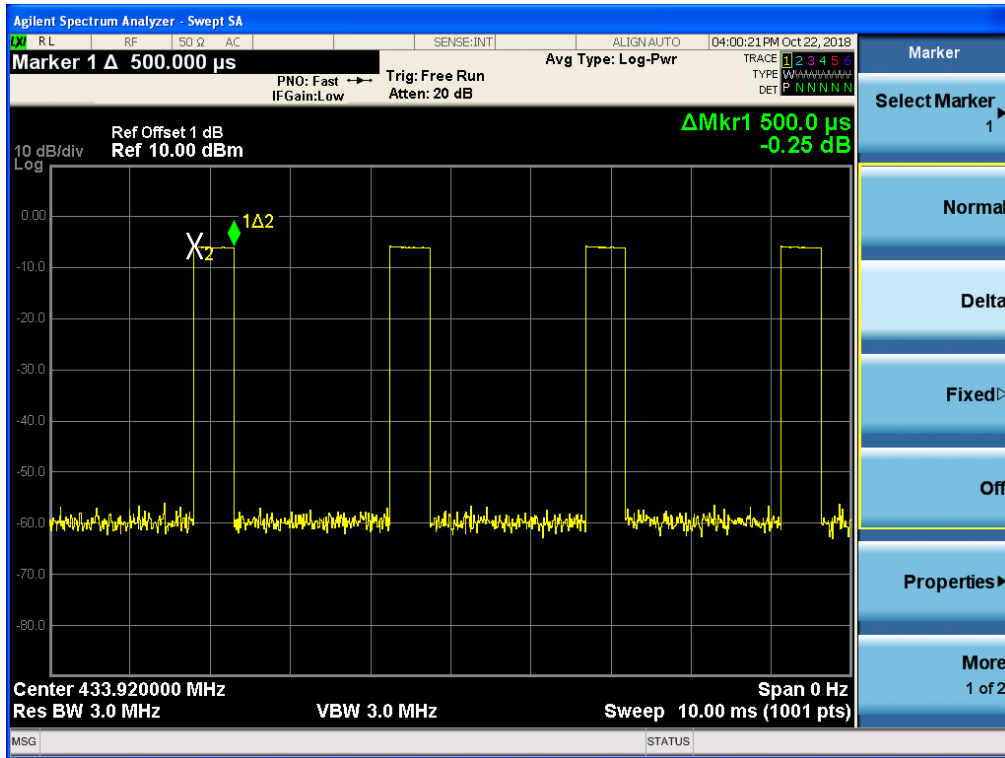

(0.5ms per burst)



3.3. 20dB Bandwidth

Limit

According to 47 CFR 15.231(c) The bandwidth of the emission shall be no wider than 0.25% of the centre frequency for devices operating above 70MHz and below 900MHz. Bandwidth is determined at the points 20dB down from the modulated carrier.

Test Configuration

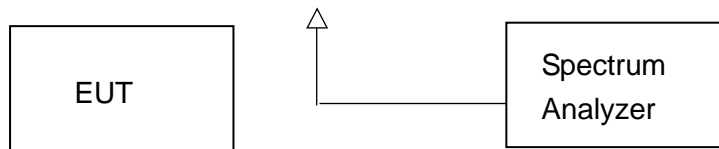

Test Procedure

The 20dB bandwidth and 99% bandwidth is measured with a spectrum analyzer connected via a receive antenna placed near the EUT while the EUT is operating in transmission mode.

The 20dB bandwidth is defined as the total spectrum the power of which is higher than peak power minus 20dB.

The occupied bandwidth (OBW), that is the frequency bandwidth such that, below its lower and above its upper frequency limits, the mean powers radiated are each equal to 0.5 percent of the total mean power radiated by a given emission.

Test Results

Modulation	Channel Frequency (MHz)	99% OBW (KHz)	20dB bandwidth (KHz)	Limit (KHz)	Result
ASK	433.92	54.788	15.13	$0.25\% * 433.92 = 1084.8$	Pass

Test plot as follows:

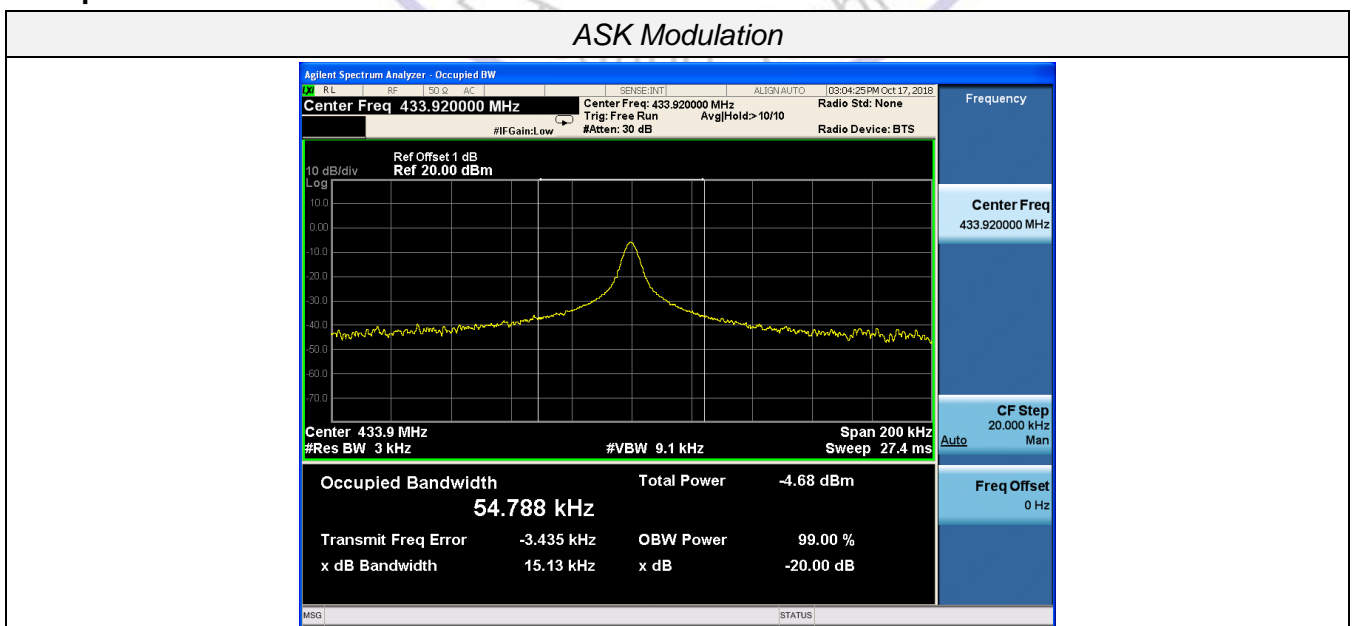

3.4. Transmission Time

Limit

According to FCC §15.231(e), devices operated under the provisions of this paragraph shall be provided with a means for automatically limiting operation so that the duration of each transmission shall not be greater than one second and the silent period between transmissions shall be at least 30 times the duration of the transmission but in no case less than 10 seconds..

Test Configuration

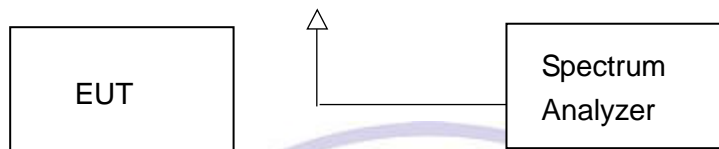

Test Procedure

1. The EUT was placed on a wooded table which is 0.8m height and close to receiver antenna of spectrum analyzer.
2. The spectrum analyzer resolution bandwidth was set to 3 MHz and video bandwidth was set to 3 MHz to encompass all significant spectral components during the test. The spectrum analyzer was operated in linear scale and zero span mode after tuning to the transmitter carrier frequency.

TEST RESULTS

Frequency (MHz)	Transmission time (S)	Limit (S)	Silent time (S)	Limit (S)	Result
433.92	0.600	1	93.75	30 times Transmission time; no less than 10s	Pass

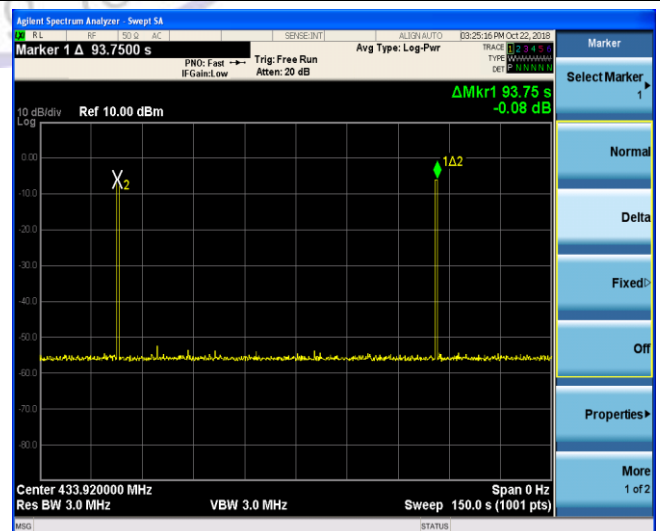
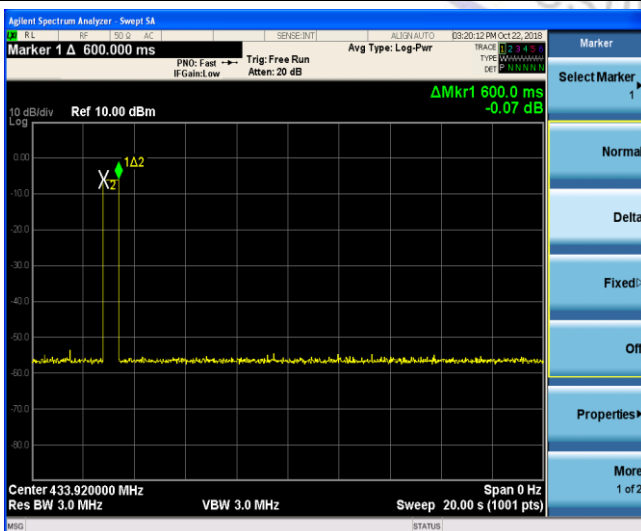

3.5. Antenna Requirement

Standard Applicable

According to FCC Part 15C 15.203

- a) An intentional radiator shall be de-signed to ensure that no antenna other than that furnished by the responsible party shall be used with the device.
- b) The manufacturer may design the unit so that a broken antenna can be replaced by the user, but the use of a standard antenna jack or electrical connector is prohibited.

Refer to statement below for compliance.

The manufacturer may design the unit so that the user can replace a broken antenna, but the use of a standard antenna jack or electrical connector is prohibited. Further, this requirement does not apply to intentional radiators that must be professionally installed.

Antenna Connected Construction

The antenna used in this product is an internal Antenna, The directional gains of antenna used for transmitting is 0 dBi.

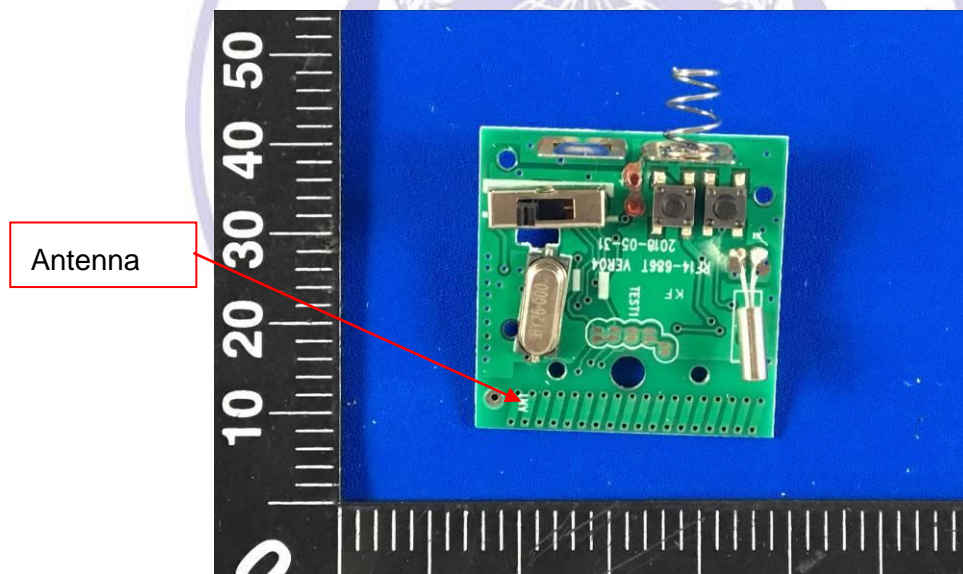

4. Test Setup Photos of the EUT



5. External and Internal Photos of the EUT

External photos

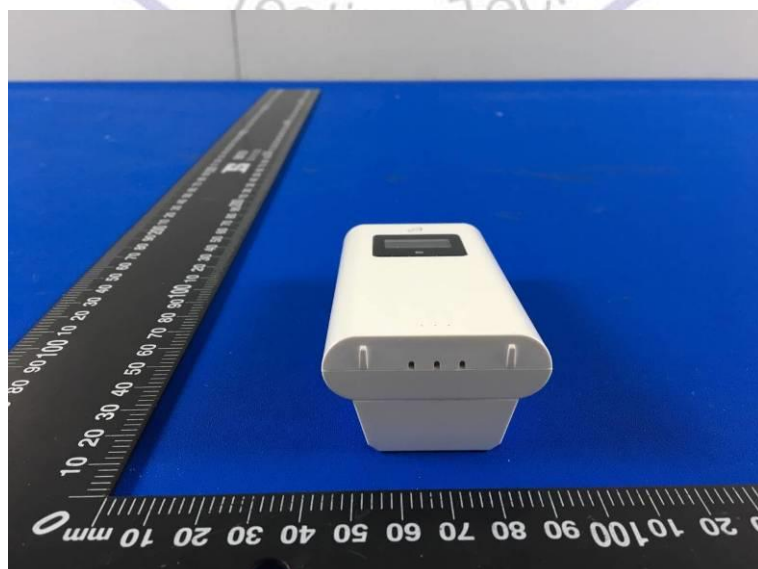

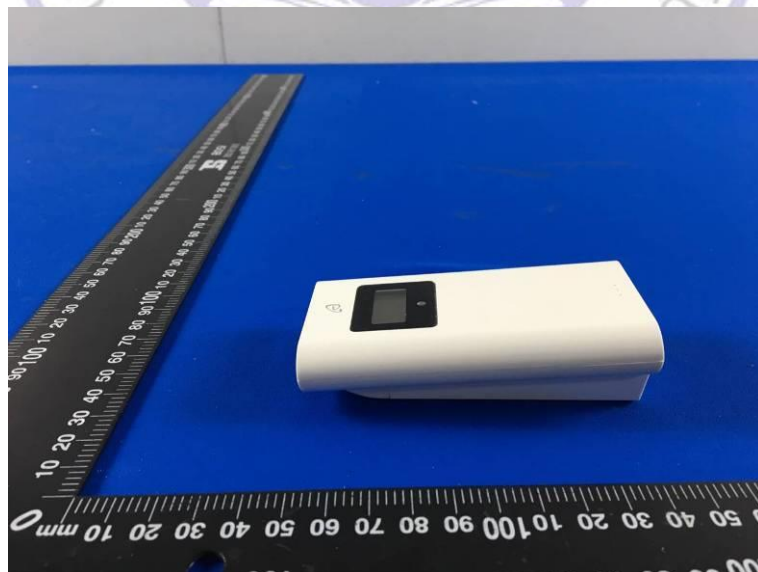
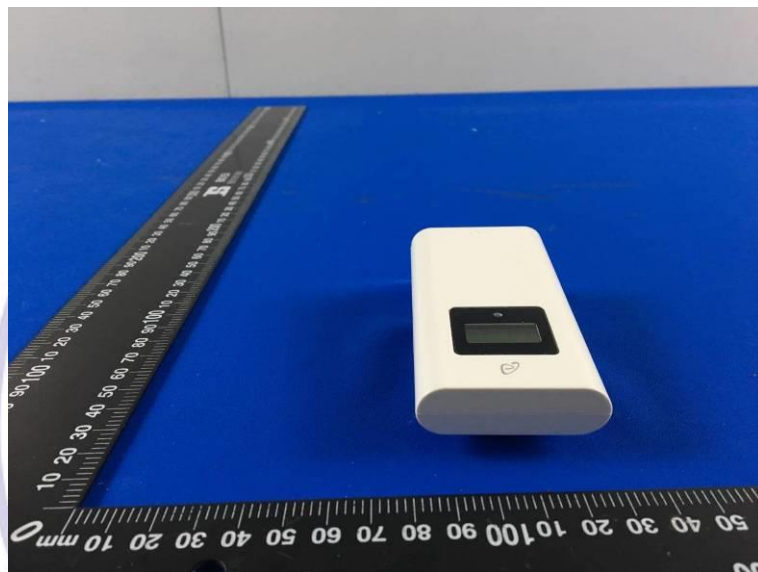
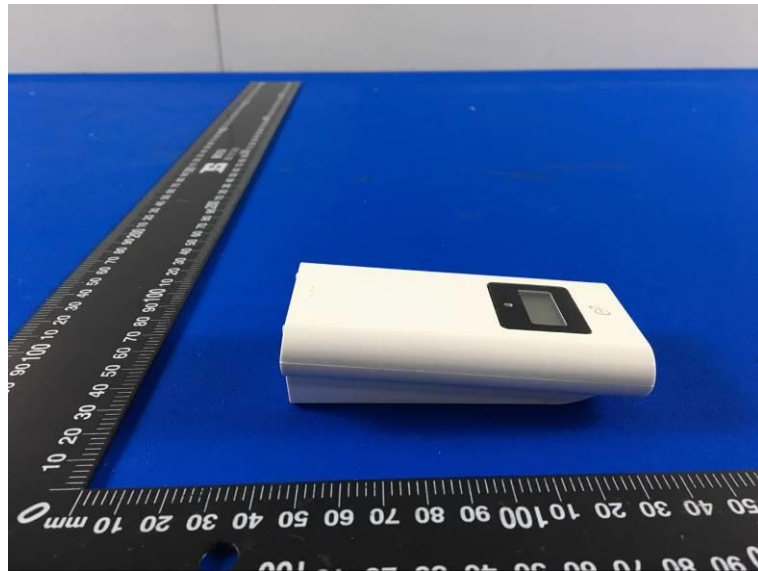

Internal Photos of EUT

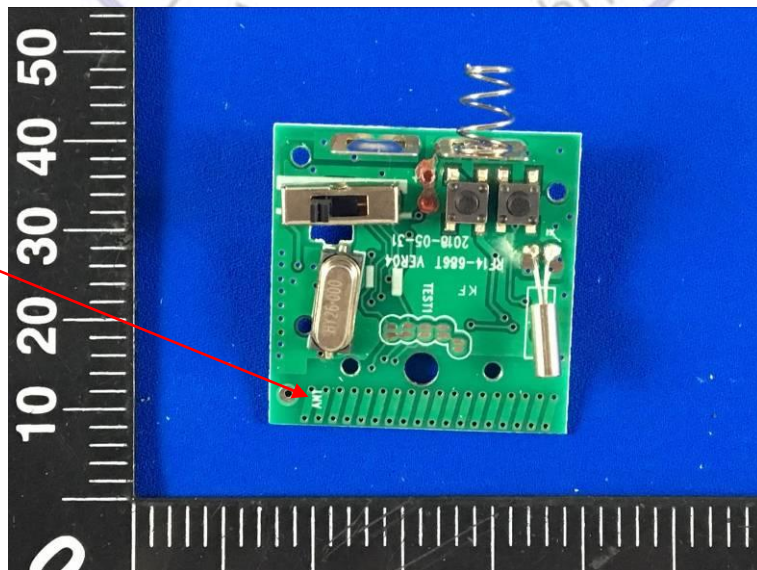
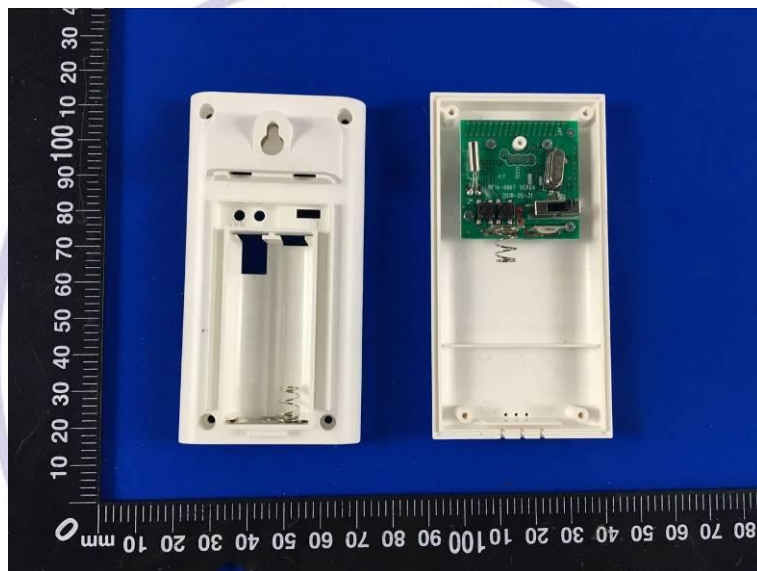

Antenna

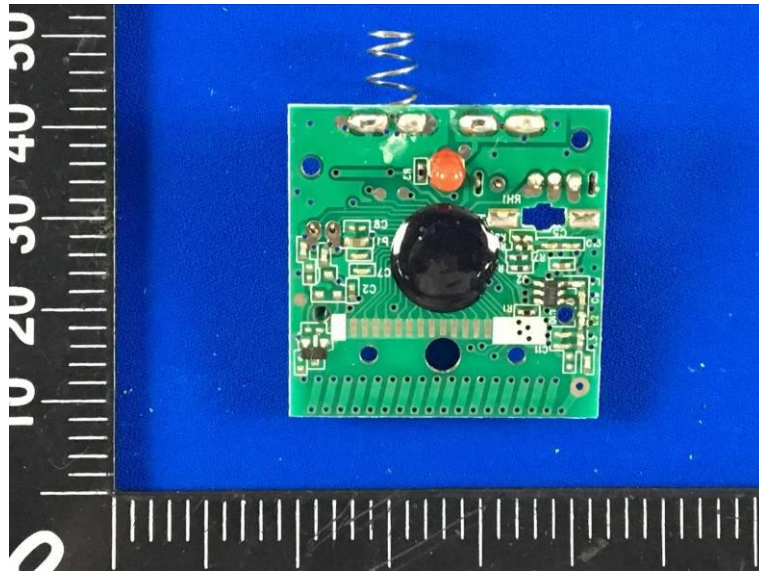

***** End of Report *****

