



MET Labs

HEADQUARTERS: 914 WEST PATAPSCO AVENUE • BALTIMORE, MARYLAND 21230 • PHONE (410) 354-3300 • FAX (410) 354-3313

April 25, 2019

OnAsset Intelligence, Inc.
8407 Sterling St
Irving, TX 75063

Dear Shawn Key,

Enclosed is the EMC Wireless test report for compliance testing of the OnAsset Intelligence, Inc., Sentinel 100S and Sentinel 100B as tested to the requirements of Title 47 of the CFR, Ch. 1 (10-1-06 ed.), Part 15 Subpart C for Intentional Radiators.

Thank you for using the services of Eurofins | MET Labs, Inc. If you have any questions regarding these results or if MET can be of further service to you, please feel free to contact me.

Sincerely yours,
EUROFINS | MET LABS, INC.

A handwritten signature in blue ink that reads "Joel Huna".

Joel Huna
Documentation Department

Reference: (\OnAsset Intelligence, Inc.\EMCA100631C-FCC247 Rev. 1)

Certificates and reports shall not be reproduced except in full, without the written permission of Eurofins | MET Labs, Inc. While use of the A2LA logo in this report reflects MET accreditation under these programs, the report must not be used by the client to claim product certification, approval, or endorsement by A2LA or any agency of the Federal Government. This letter of transmittal is not a part of the attached report.



Maryland | California | Texas | China | Korea | Taiwan
www.metlabs.com

Electromagnetic Compatibility Criteria Test Report

for the

**OnAsset Intelligence, Inc.
Sentinel 100S, Sentinel 100B**

Tested under
the FCC Certification Rules
contained in
15.247 Subpart C for Intentional Radiators

MET Report: EMCA100631C-FCC247 Rev. 1

April 25, 2019

Prepared For:

**OnAsset Intelligence, Inc.
8407 Sterling St
Irving, TX 75063**

Prepared By:
Eurofins | MET Labs, Inc.
13501 McCallen Pass,
Austin TX 78753

Electromagnetic Compatibility Criteria Test Report

for the

**OnAsset Intelligence, Inc.
Sentinel 100S, Sentinel 100B**

Tested under
the FCC Certification Rules
contained in
15.247 Subpart C for Intentional Radiators



Jonathan Tavira, Project Engineer
Electromagnetic Compatibility Lab



Joel Huna
Documentation Department

Engineering Statement: The measurements shown in this report were made in accordance with the procedures indicated, and the emissions from this equipment were found to be within the limits applicable. I assume full responsibility for the accuracy and completeness of these measurements, and for the qualifications of all persons taking them. It is further stated that upon the basis of the measurements made, the equipment tested is capable of operation in accordance with the requirements of the FCC Rules Part 15.247 under normal use and maintenance.



John Mason,
Director, Electromagnetic Compatibility Lab

Report Status Sheet

Revision	Report Date	Reason for Revision
∅	January 9, 2018	Initial Issue.
1	April 25, 2019	Data rate has been specified as 1 Mbps.

Table of Contents

I.	Executive Summary	1
	A. Purpose of Test	2
	B. Executive Summary	2
II.	Equipment Configuration	3
	A. Overview.....	4
	B. References.....	5
	C. Test Site	5
	D. Measurement Uncertainty	5
	E. Description of Test Sample.....	6
	F. Equipment Configuration.....	6
	G. Support Equipment	6
	H. Ports and Cabling Information.....	6
	I. Mode of Operation.....	8
	J. Method of Monitoring EUT Operation	8
	K. Modifications	8
	a) Modifications to EUT.....	8
	b) Modifications to Test Standard.....	8
	L. Disposition of EUT.....	8
III.	Electromagnetic Compatibility Criteria for Intentional Radiators.....	9
	§ 15.203 Antenna Requirement	10
	§ 15.207(a) Conducted Emissions Limits.....	11
	§ 15.247(a)(2) 6 dB Bandwidth.....	14
	§ 15.247(b)(3) Maximum Conducted Output Power.....	17
	§ 15.209 Radiated Spurious Emissions Requirements and Band Edge	19
	§ 15.247(c) Spurious Emissions in Non-restricted Bands	37
	§ 15.247(e) Peak Power Spectral Density	42
	§ 15.247(i) Maximum Permissible Exposure	44
IV.	Test Equipment	45
V.	Certification & User’s Manual Information.....	47
	A. Certification Information	48
	B. Label and User’s Manual Information	52

List of Tables

Table 1. Executive Summary of EMC Part 15.247 Compliance Testing	2
Table 2. EUT Summary Table.....	4
Table 3. References	5
Table 4. Uncertainty Calculations Summary.....	5
Table 5. Equipment Configuration	6
Table 6. Support Equipment.....	6
Table 7. Ports and Cabling Information	6
Table 8. Antenna List	10
Table 9. Conducted Limits for Intentional Radiators from FCC Part 15 § 15.207(a)	11
Table 10. Conducted Emissions, Bonding Information.....	11
Table 11. Conducted Emissions, Test Results.....	12
Table 12. 6 dB Occupied Bandwidth, Test Results	14
Table 13. Output Power Requirements from §15.247(b)(3).....	17
Table 14. Maximum Conducted Output Power, Test Results	17
Table 15. Restricted Bands of Operation.....	19
Table 16. Radiated Emissions Limits Calculated from FCC Part 15, § 15.209 (a)	20
Table 17. Power Spectral Density, Test Results.....	42
Table 18. Test Equipment List	46

List of Plots

Plot 1. Conducted Emissions, Phase Line	13
Plot 2. Conducted Emissions, Neutral Line.....	13
Plot 3. 6 dB Occupied Bandwidth, 2402 MHz	15
Plot 4. 6 dB Occupied Bandwidth, 2440 MHz	15
Plot 5. 6 dB Occupied Bandwidth, 2480 MHz	15
Plot 6. Occupied Bandwidth Setup.....	16
Plot 7. Maximum Conducted Output Power, 2402 MHz, Integrated Band Power	18
Plot 8. Maximum Conducted Output Power, 2440 MHz, Integrated Band Power	18
Plot 9. Maximum Conducted Output Power, 2480 MHz, Integrated Band Power	18
Plot 10. Radiated Emissions, 2402 MHz, 30 – 1000 MHz, Vertical	21
Plot 11. Radiated Emissions, 2402 MHz, 30 – 1000 MHz, Horizontal	21
Plot 12. Radiated Emissions, 2402 MHz, 1 – 7 GHz, Peak, Vertical	21
Plot 13. Radiated Emissions, 2402 MHz, 1 – 7 GHz, Peak, Horizontal	22
Plot 14. Radiated Emissions, 2402 MHz, 1 – 7 GHz, Average, Vertical	22
Plot 15. Radiated Emissions, 2402 MHz, 1 – 7 GHz, Average, Horizontal	22
Plot 16. Radiated Emissions, 2402 MHz, 7 – 18 GHz, Peak, Vertical	23
Plot 17. Radiated Emissions, 2402 MHz, 7 – 18 GHz, Peak, Horizontal	23
Plot 18. Radiated Emissions, 2402 MHz, 7 – 18 GHz, Average, Vertical	23
Plot 19. Radiated Emissions, 2402 MHz, 7 – 18 GHz, Average, Horizontal	24
Plot 20. Radiated Emissions, 2440 MHz, 30 – 1000 MHz, Vertical	24
Plot 21. Radiated Emissions, 2440 MHz, 30 – 1000 MHz, Horizontal	24
Plot 22. Radiated Emissions, 2440 MHz, 1 – 7 GHz, Peak, Vertical	25
Plot 23. Radiated Emissions, 2440 MHz, 1 – 7 GHz, Peak, Horizontal	25
Plot 24. Radiated Emissions, 2440 MHz, 1 – 7 GHz, Average, Vertical	25
Plot 25. Radiated Emissions, 2440 MHz, 1 – 7 GHz, Average, Horizontal	26
Plot 26. Radiated Emissions, 2440 MHz, 7 – 18 GHz, Peak, Vertical	26
Plot 27. Radiated Emissions, 2440 MHz, 7 – 18 GHz, Peak, Horizontal	26

Plot 28. Radiated Emissions, 2440 MHz, 7 – 18 GHz, Average, Vertical	27
Plot 29. Radiated Emissions, 2440 MHz, 7 – 18 GHz, Average, Horizontal	27
Plot 30. Radiated Emissions, 2440 MHz, 18 – 25 GHz, Peak, Vertical	27
Plot 31. Radiated Emissions, 2440 MHz, 18 – 25 GHz, Peak, Horizontal	28
Plot 32. Radiated Emissions, 2440 MHz, 18 – 25 GHz, Average, Vertical	28
Plot 33. Radiated Emissions, 2440 MHz, 18 – 25 GHz, Average, Horizontal	28
Plot 34. Radiated Emissions, 2480 MHz, 30 – 1000 MHz, Vertical	29
Plot 35. Radiated Emissions, 2480 MHz, 30 – 1000 MHz, Horizontal	29
Plot 36. Radiated Emissions, 2480 MHz, 1 – 7 GHz, Peak, Vertical	29
Plot 37. Radiated Emissions, 2480 MHz, 1 – 7 GHz, Peak, Horizontal	30
Plot 38. Radiated Emissions, 2480 MHz, 1 – 7 GHz, Average, Vertical	30
Plot 39. Radiated Emissions, 2480 MHz, 1 – 7 GHz, Average, Horizontal	30
Plot 40. Radiated Emissions, 2480 MHz, 7 – 18 GHz, Peak, Vertical	31
Plot 41. Radiated Emissions, 2480 MHz, 7 – 18 GHz, Peak, Horizontal	31
Plot 42. Radiated Emissions, 2480 MHz, 7 – 18 GHz, Average, Vertical	31
Plot 43. Radiated Emissions, 2480 MHz, 7 – 18 GHz, Average, Horizontal	32
Plot 44. Radiated Restricted Bandedge, 2402 MHz, Peak, Vertical	33
Plot 45. Radiated Restricted Bandedge, 2402 MHz, Peak, Horizontal	33
Plot 46. Radiated Restricted Bandedge, 2402 MHz, Average, Vertical	34
Plot 47. Radiated Restricted Bandedge, 2402 MHz, Average, Horizontal	34
Plot 48. Radiated Restricted Bandedge, 2480 MHz, Peak, Vertical	34
Plot 49. Radiated Restricted Bandedge, 2480 MHz, Peak, Horizontal	35
Plot 50. Radiated Restricted Bandedge, 2480 MHz, Average, Vertical	35
Plot 51. Radiated Restricted Bandedge, 2480 MHz, Average, Horizontal	35
Plot 52. 100 kHz Spurious Emissions, 2402 MHz, 30 – 1000 MHz	38
Plot 53. 100 kHz Spurious Emissions, 2402 MHz, 1 – 25 GHz	38
Plot 54. 100 kHz Spurious Emissions, 2440 MHz, 30 – 1000 MHz	39
Plot 55. 100 kHz Spurious Emissions, 2440 MHz, 1 – 25 GHz	39
Plot 56. 100 kHz Spurious Emissions, 2480 MHz, 30 -1000 MHz	39
Plot 57. 100 kHz Spurious Emissions, 2480 MHz, 1- 25 GHz	40
Plot 58. Conducted Bandedge, 2402 MHz	41
Plot 59. Conducted Bandedge, 2480 MHz	41
Plot 60. Power Density, 2402 MHz, 100 kHz RBW	43
Plot 61. Power Density, 2440 MHz, 30 kHz RBW	43
Plot 62. Power Density, 2480 MHz, 100 kHz	43

List of Figures

Figure 1. Block Diagram of Test Configuration..... 6
Figure 2. Block Diagram, Occupied Bandwidth Test Setup..... 14
Figure 3. Maximum Conducted Output Power, Block Diagram of Test Configuration..... 17
Figure 4. Spurious Emission in Non-restricted Bands, Block Diagram of Test Setup 37

List of Terms and Abbreviations

AC	Alternating Current
ACF	Antenna Correction Factor
Cal	Calibration
<i>d</i>	Measurement Distance
dB	Decibels
dB μ A	Decibels above one microamp
dB μ V	Decibels above one microvolt
dB μ A/m	Decibels above one microamp per meter
dB μ V/m	Decibels above one microvolt per meter
DC	Direct Current
E	Electric Field
DSL	Digital Subscriber Line
ESD	Electrostatic Discharge
EUT	Equipment Under Test
<i>f</i>	Frequency
FCC	Federal Communications Commission
GRP	Ground Reference Plane
H	Magnetic Field
HCP	Horizontal Coupling Plane
Hz	Hertz
IEC	International Electrotechnical Commission
kHz	kilohertz
kPa	kilopascal
kV	kilovolt
LISN	Line Impedance Stabilization Network
MHz	Megahertz
μ H	microhenry
μ	microfarad
μ s	microseconds
NEBS	Network Equipment-Building System
PRF	Pulse Repetition Frequency
RF	Radio Frequency
RMS	Root-Mean-Square
TWT	Traveling Wave Tube
V/m	Volts per meter
VCP	Vertical Coupling Plane

I. Executive Summary

A. Purpose of Test

An EMC evaluation was performed to determine compliance of the OnAsset Intelligence, Inc. Sentinel 100S and Sentinel 100B, with the requirements of Part 15, §15.247. All references are to the most current version of Title 47 of the Code of Federal Regulations in effect. In accordance with §2.1033, the following data is presented in support of the Certification of the Sentinel 100S and Sentinel 100B. OnAsset Intelligence, Inc. should retain a copy of this document which should be kept on file for at least two years after the manufacturing of the Sentinel 100S and Sentinel 100B, have been **permanently** discontinued.

B. Executive Summary

The following tests were conducted on a sample of the equipment for the purpose of demonstrating compliance with Part 15, §15.247, in accordance with OnAsset Intelligence, Inc., purchase order number 5421. All tests were conducted using measurement procedure ANSI C63.10-2013.

FCC Reference 47 CFR Part 15.247:2005	Description	Compliance
Title 47 of the CFR, Part 15 §15.203	Antenna Requirement	Compliant
Title 47 of the CFR, Part 15 §15.207(a)	Conducted Emission Limits	Compliant
Title 47 of the CFR, Part 15 §15.247(a)(2)	6dB Occupied Bandwidth	Compliant
Title 47 of the CFR, Part 15 §15.247(b)(3)	Maximum Conducted Output Power	Compliant
Title 47 of the CFR, Part 15 §15.247(c)	Spurious Emissions in Non-restricted Bands	Compliant
Title 47 of the CFR, Part 15 §15.247(d); §15.209; §15.205	Radiated Spurious Emissions Requirements	Compliant
Title 47 of the CFR, Part 15; §15.247(e)	Power Spectral Density	Compliant
Title 47 of the CFR, Part 15 §15.247(i)	Maximum Permissible Exposure (MPE)	Compliant

Table 1. Executive Summary of EMC Part 15.247 Compliance Testing

II. Equipment Configuration

A. Overview

Eurofins | MET Labs, Inc. was contracted by OnAsset Intelligence, Inc. to perform testing on the Sentinel 100S to cover model Sentinel 100B, under OnAsset Intelligence, Inc.’s purchase order number 5421.

This document describes the test setups, test methods, required test equipment, and the test limit criteria used to perform compliance testing of the OnAsset Intelligence, Inc., Sentinel 100S to cover testing for the Sentinel 100B.

The results obtained relate only to the item(s) tested.

Model(s) Tested:	Sentinel 100S	
Model(s) Covered:	Sentinel 100S, Sentinel 100B	
EUT Specifications:	Primary Power: 5 VDC	
	FCC ID: 2ARLF-100B	
	Type of Modulations:	GFSK
	Equipment Code:	DTS
	Max RF Output Power:	17.11 dBm
	EUT Frequency Ranges:	2402 MHz to 2480 MHz
	Data Rate:	1 Mbps
Analysis:	The results obtained relate only to the item(s) tested.	
Environmental Test Conditions:	Temperature: 15-35° C	
	Relative Humidity: 30-60%	
	Barometric Pressure: 860-1060 mbar	
Evaluated by:	Jonathan Tavira	
Report Date(s):	April 25, 2019	

Table 2. EUT Summary Table

B. References

CFR 47, Part 15, Subpart C	Federal Communication Commission, Code of Federal Regulations, Title 47, Part 15: General Rules and Regulations, Allocation, Assignment, and Use of Radio Frequencies
ANSI C63.4:2014	Methods and Measurements of Radio-Noise Emissions from Low-Voltage Electrical And Electronic Equipment in the Range of 9 kHz to 40 GHz
ISO/IEC 17025:2005	General Requirements for the Competence of Testing and Calibration Laboratories
ANSI C63.10:2013	American National Standard for Testing Unlicensed Wireless Devices
KDB 558074 v05	Guidance For Performing Compliance Measurements On Digital Transmission Systems (DTS) Operating Under Section 15.247

Table 3. References

C. Test Site

All testing was performed at Eurofins | MET Labs, Inc., 13501 McCallen Pass, Austin TX 78753. All equipment used in making physical determinations is accurate and bears recent traceability to the National Institute of Standards and Technology.

Radiated Emissions measurements were performed in a 10 meter semi-anechoic chamber (equivalent to an Open Area Test Site). In accordance with §2.948(a)(3), a complete site description is contained at MET Laboratories.

D. Measurement Uncertainty

Test Method	Typical Expanded Uncertainty	K	Confidence Level
RF Frequencies	±4.52 Hz	2	95%
RF Power Conducted Emissions	±2.97 dB	2	95%
RF Power Radiated Emissions, <1GHz	±2.95 dB	2	95%
RF Power Radiated Emissions, >1GHz	±3.54 dB	2	95%

Table 4. Uncertainty Calculations Summary

E. Description of Test Sample

The OnAsset Intelligence, Inc. Sentinel 100S, Equipment Under Test (EUT), is a BLE scanning accessory used to scan Sentinel tags in its vicinity.

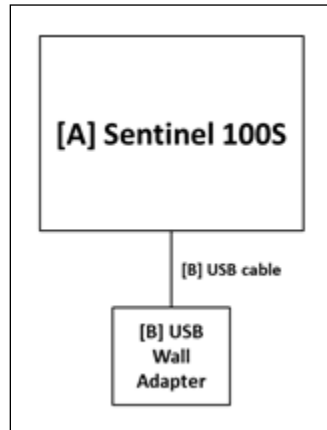

Figure 1. Block Diagram of Test Configuration

F. Equipment Configuration

The EUT was set up as outlined in Figure 1, Block Diagram of Test Setup. All cards, racks, etc., incorporated as part of the EUT is included in the following list.

Ref. ID	Slot #	Name / Description	Model Number	Part Number	Serial Number	Rev. #
A	N/A	Sentinel 100S	Sentinel 100S	N/A	N/A	1

Table 5. Equipment Configuration

G. Support Equipment

Support equipment necessary for the operation and testing of the EUT is included in the following list.

Ref. ID	Name / Description	Manufacturer	Model Number	*Customer Supplied Calibration Data
B	USB Cable	OnAsset Intelligence, Inc.	38-5011-000	N/A
B	USB Wall Adapter	Homuspot	S005AYU0500100	N/A

The 'Customer Supplied Calibration Data' column will be marked as either not applicable, not available, or will contain the calibration date supplied by the customer.

Table 6. Support Equipment

H. Ports and Cabling Information

Ref. ID	Port name on EUT	Cable Description or reason for no cable	Qty	Length as tested (m)	Max Length (m)	Shielded? (Y/N)	Termination Box ID & Port Name
1	USB Cable	OnAsset Intelligence, Inc.	1	3 meters	6 meters	Yes	[1] USB Cable

Table 7. Ports and Cabling Information

I. Mode of Operation

Sentinel 100S was configured to transmit at a data rate of 1 Mbps with a duty cycle $\geq 98\%$ for the following operating channels: 2402 MHz, 2440 MHz, and 2480 MHz. Channel selection and output power were configured through the use of the Silicon Labs' EFR32BG Bluetooth Smart Starter Kit.

J. Method of Monitoring EUT Operation

Transmission of the Sentinel 100P was verified through the Bluetooth Smart Starter Kit.

K. Modifications**a) Modifications to EUT**

No modifications were made to the EUT.

b) Modifications to Test Standard

No modifications were made to the test standard.

L. Disposition of EUT

The test sample including all support equipment submitted to the Electro-Magnetic Compatibility Lab for testing was returned to OnAsset Intelligence, Inc. upon completion of testing.

III. Electromagnetic Compatibility Criteria for Intentional Radiators

Electromagnetic Compatibility Criteria for Intentional Radiators

§ 15.203 Antenna Requirement

Test Requirement: § 15.203: An intentional radiator shall be designed to ensure that no antenna other than that furnished by the responsible party shall be used with the device. The use of a permanently attached antenna or of an antenna that uses a unique coupling to the intentional radiator shall be considered sufficient to comply with the provisions of this section. The manufacturer may design the unit so that a broken antenna can be replaced by the user, but the use of a standard antenna jack or electrical connector is prohibited.

The structure and application of the EUT were analyzed to determine compliance with Section 15.203 of the Rules. Section 15.203 states that the subject device must meet at least one of the following criteria:

- a.) Antenna must be permanently attached to the unit.
- b.) Antenna must use a unique type of connector to attach to the EUT.
- c.) Unit must be professionally installed. Installer shall be responsible for verifying that the correct antenna is employed with the unit.

Results: The EUT as tested is compliant the criteria of §15.203. The EUT utilizes an etched PCB antenna, which is to be considered permanently attached to the EUT.

Test Engineer(s): Jonathan Tavira

Test Date(s): September 7, 2018

Antenna Gain	Antenna Type
-3 dBi	PCB etched F type

Table 8. Antenna List

Electromagnetic Compatibility Criteria for Intentional Radiators

§ 15.207(a) Conducted Emissions Limits

Test Requirement(s): § 15.207 (a): For an intentional radiator that is designed to be connected to the public utility (AC) power line, the radio frequency voltage that is conducted back onto the AC power line on any frequency or frequencies, within the band 150 kHz to 30MHz, shall not exceed the limits in the following table, as measured using a 50 μ H/50 Ω line impedance stabilization network (LISN). Compliance with the provisions of this paragraph shall be based on the measurement of the radio frequency voltage between each power line and ground at the power terminal. The lower limit applies at the boundary between the frequency ranges.

Frequency range (MHz)	§ 15.207(a), Conducted Limit (dB μ V)	
	Quasi-Peak	Average
* 0.15- 0.5	66 - 56	56 - 46
0.5 - 5	56	46
5 - 30	60	50

Table 9. Conducted Limits for Intentional Radiators from FCC Part 15 § 15.207(a)

Test Procedure: The EUT was placed on a 0.8 m-high wooden table inside a screen room. The EUT was situated such that the back of the EUT was 0.4 m from one wall of the vertical ground plane, and the remaining sides of the EUT were no closer than 0.8 m from any other conductive surface. The EUT was powered from a 50 Ω /50 μ H Line Impedance Stabilization Network (LISN). The EMC receiver scanned the frequency range from 150 kHz to 30 MHz. Conducted Emissions measurements were made in accordance with *ANSI C63.4-2014 "Methods and Measurements of Radio-Noise Emissions from Low-Voltage Electrical and Electronic Equipment in the Range of 9kHz to 40 GHz"*. The measurements were performed over the frequency range of 0.15 MHz to 30 MHz using a 50 Ω /50 μ H LISN as the input transducer to an EMC/field intensity meter. For the purpose of this testing, the transmitter was turned on. Scans were performed with the transmitter on.

Test Results: The EUT was compliant with this requirement. Measured emissions were within applicable limits.

Test Engineer(s): Jonathan Tavira

Test Date(s): September 7, 2018

Meas. Location	Meas. m	Limit	Pass/Fail
Bonding measurement from LISN ground to ground plane	1.065	< 2.5 m Ω	Pass

Table 10. Conducted Emissions, Bonding Information

Conducted Emissions Test Results

Line	Freq (MHz)	QP Amplitude	QP Limit	Delta	Pass	Average Amplitude	Average Limit	Delta	Pass	Notes
Line - 120VAC 60Hz	0.474	37.09	56.456	-19.366	Pass	34.82	46.456	-11.636	Pass	None
Line - 120VAC 60Hz	0.150	33.36	66	-32.64	Pass	25.68	56	-30.32	Pass	None
Line - 120VAC 60Hz	8.958	31.36	60	-28.64	Pass	23.8	50	-26.2	Pass	None
Line - 120VAC 60Hz	7.398	32.42	60	-27.58	Pass	25.23	50	-24.77	Pass	None
Line - 120VAC 60Hz	10.550	30.25	60	-29.75	Pass	23.36	50	-26.64	Pass	None
Line - 120VAC 60Hz	0.898	29.86	56	-26.14	Pass	26.99	46	-19.01	Pass	None
Neutral - 120VAC 60Hz	8.438	30.47	60	-29.53	Pass	23.58	50	-26.42	Pass	None
Neutral - 120VAC 60Hz	7.938	30.97	60	-29.03	Pass	23.61	50	-26.39	Pass	None
Neutral - 120VAC 60Hz	1.398	29.98	56	-26.02	Pass	23.31	46	-22.69	Pass	None
Neutral - 120VAC 60Hz	0.250	28.51	61.769	-33.259	Pass	22.23	51.769	-29.539	Pass	None
Neutral - 120VAC 60Hz	1.026	29.56	56	-26.44	Pass	23.36	46	-22.64	Pass	None
Neutral - 120VAC 60Hz	0.470	31.24	56.528	-25.288	Pass	23.25	46.529	-23.279	Pass	None

Table 11. Conducted Emissions, Test Results

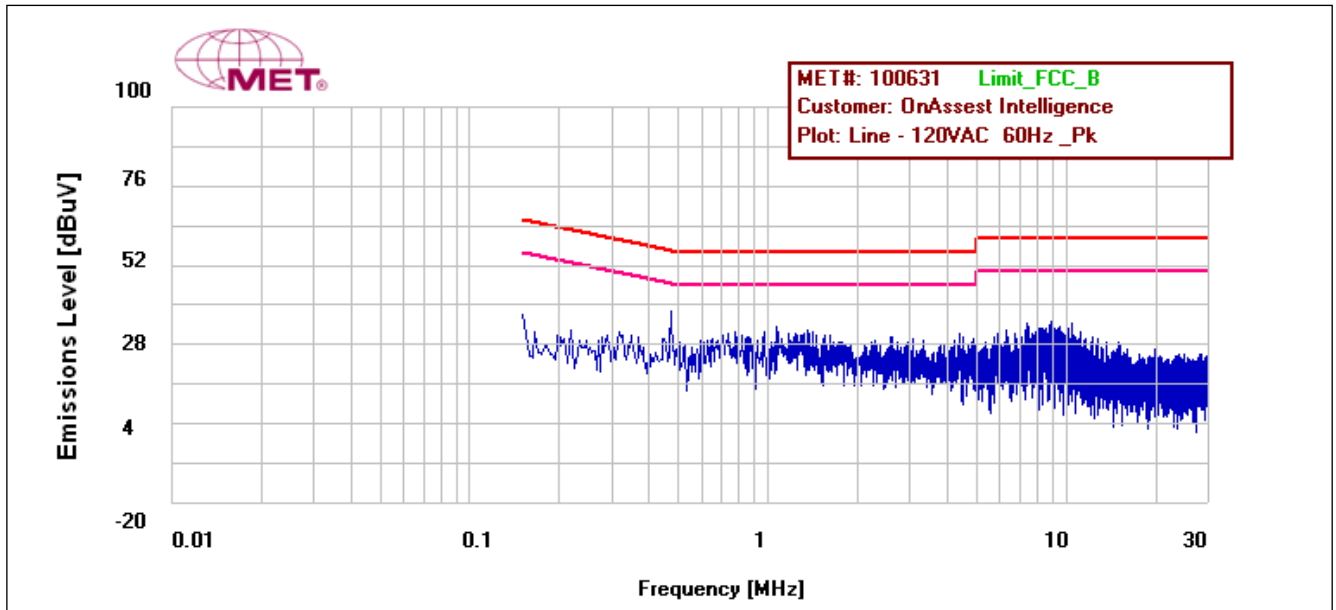

Plot 1. Conducted Emissions, Phase Line

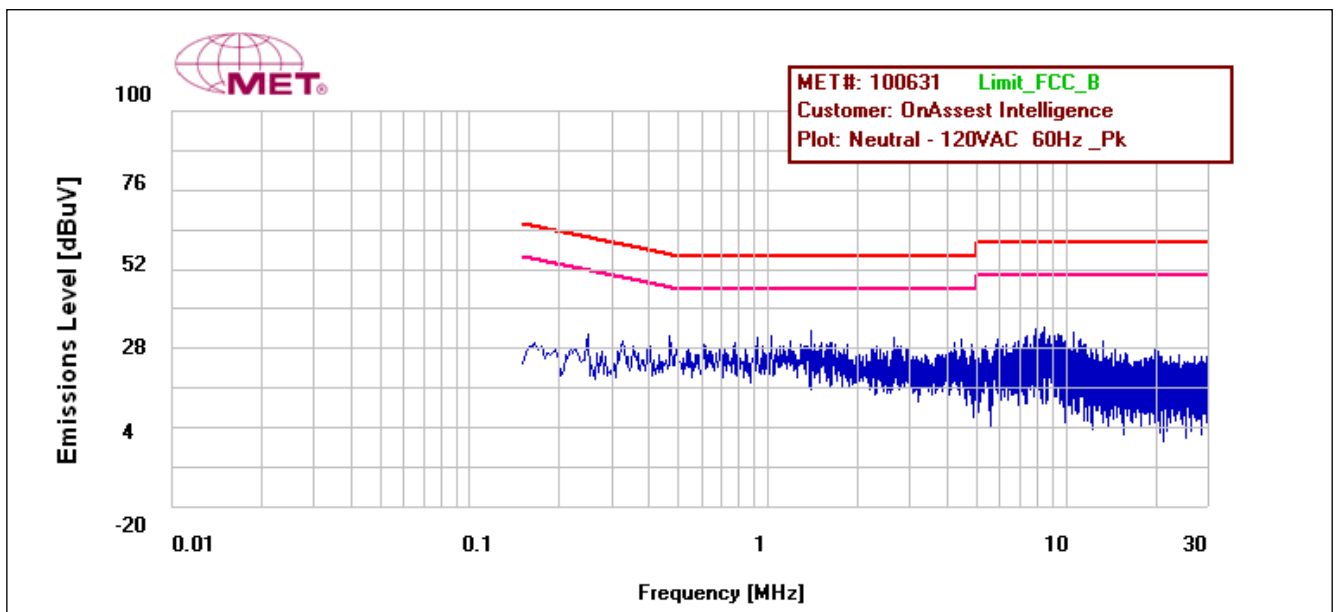

Plot 2. Conducted Emissions, Neutral Line

Electromagnetic Compatibility Criteria for Intentional Radiators

§ 15.247(a)(2) 6 dB Bandwidth

Test Requirements: § 15.247(a)(2): Operation under the provisions of this section is limited to frequency hopping and digitally modulated intentional radiators that comply with the following provisions:

For systems using digital modulation techniques, the EUT may operate in the 902-928 MHz, 2400-2483.5 MHz and 5725-5850 MHz bands. The minimum 6dB bandwidth shall be at least 500 kHz.

Test Procedure: The transmitter was on and transmitting at the highest output power. The bandwidth of the fundamental frequency was measured with the spectrum analyzer using a RBW = 100kHz, VBW = 3*RBW. The 6 dB Bandwidth was measured and recorded. The measurements were performed on the low, mid and high channels.

Test Results The EUT was compliant with § 15.247 (a)(2).

The 6 dB Bandwidth was determined from the plots on the following pages.

Test Engineer(s): Jonathan Tavira

Test Date(s): September 7, 2018

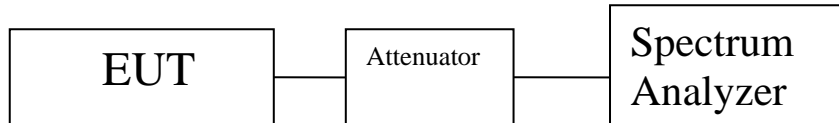

Figure 2. Block Diagram, Occupied Bandwidth Test Setup

Occupied Bandwidth Test Results

Occupied Bandwidth		
Carrier Channel	Frequency (MHz)	Measured 6 dB Bandwidth (kHz)
Low	2402	749.361
Mid	2440	742.701
High	2480	742.390

Table 12. 6 dB Occupied Bandwidth, Test Results

6 dB Occupied Bandwidth Test Results

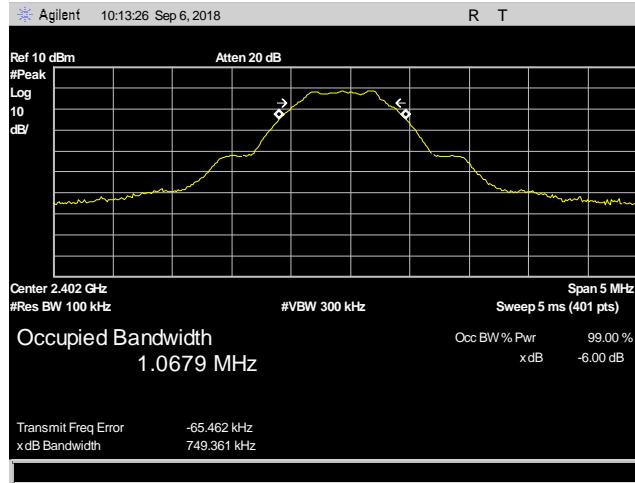

Plot 3. 6 dB Occupied Bandwidth, 2402 MHz

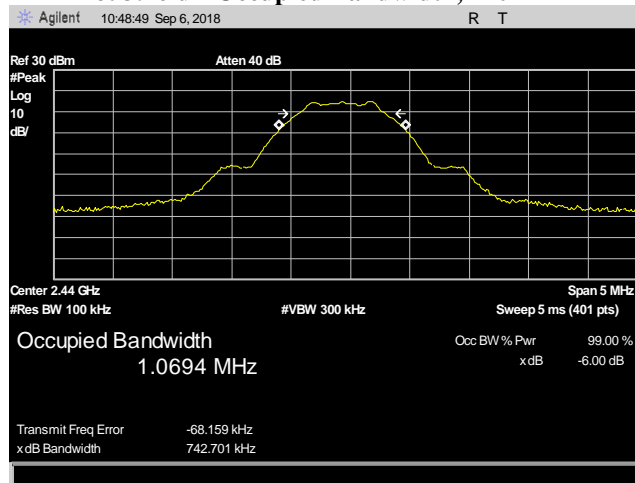

Plot 4. 6 dB Occupied Bandwidth, 2440 MHz

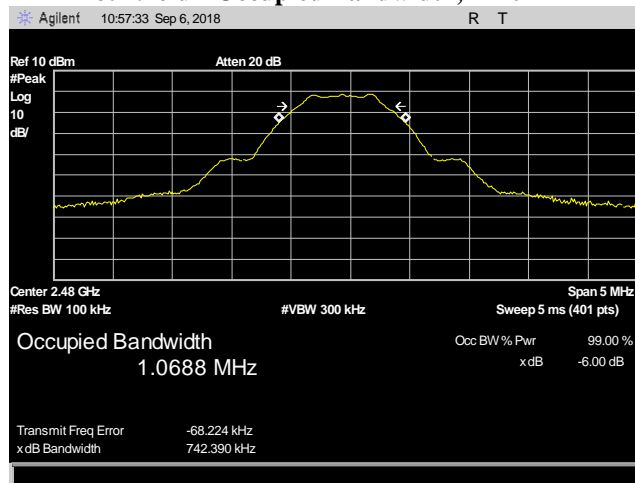

Plot 5. 6 dB Occupied Bandwidth, 2480 MHz

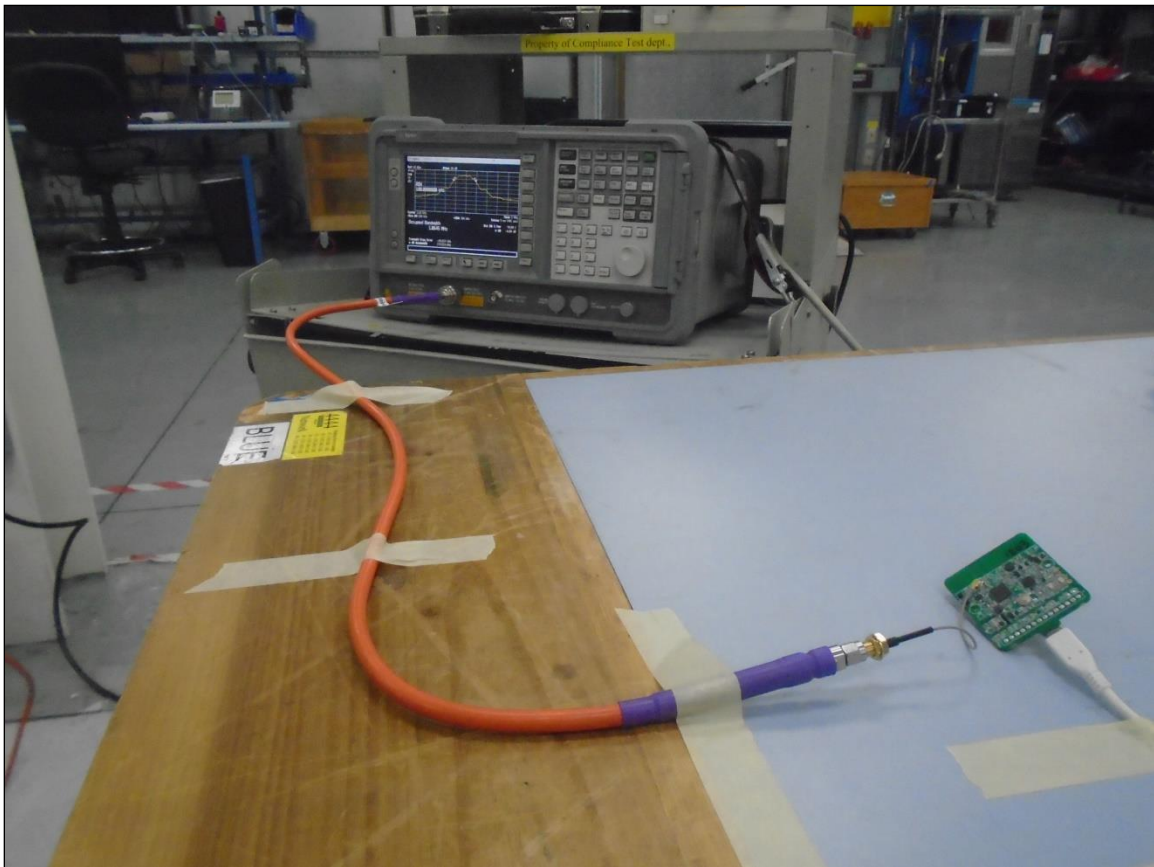

Plot 6. Occupied Bandwidth Setup

Electromagnetic Compatibility Criteria for Intentional Radiators

§ 15.247(b)(3) Maximum Conducted Output Power

Test Requirements: §15.247(b)(3): The maximum peak output power of the intentional radiator shall not exceed the following:

Digital Transmission Systems (MHz)	Output Limit (Watts)
2400–2483.5	1.000

Table 13. Output Power Requirements from §15.247(b)(3)

§15.247(c): if transmitting antennas of directional gain greater than 6 dBi are used the peak output power from the intentional radiator shall be reduced below the stated values in the above table, as appropriate, by the amount in dB that the directional gain of the antenna exceeds 6 dBi.

Test Procedure: The EUT was measured at the low, mid and high channels of each band at the maximum power level. Measurements were performed in a conducted setup as shown in figure 3. The measurements were performed on the low, mid and high channels..

Test Results: The EUT was compliant with the maximum conducted output power limits of §15.247(b)(3).

Test Engineer(s): Jonathan Tavira

Test Date(s): December 12, 2018

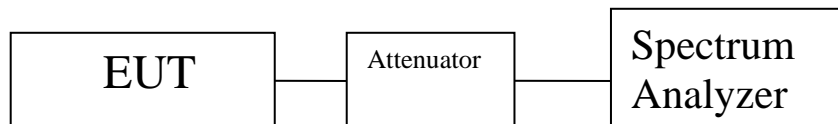

Figure 3. Maximum Conducted Output Power, Block Diagram of Test Configuration

Maximum Conducted Output Power Test Results

Maximum Conducted Output Power		
Carrier Channel	Frequency (MHz)	Average Conducted Power (dBm)
Low	2405	0.11
Mid	2440	17.11
High	2480	0.94

Table 14. Maximum Conducted Output Power, Test Results

Maximum Conducted Output Power Test Results

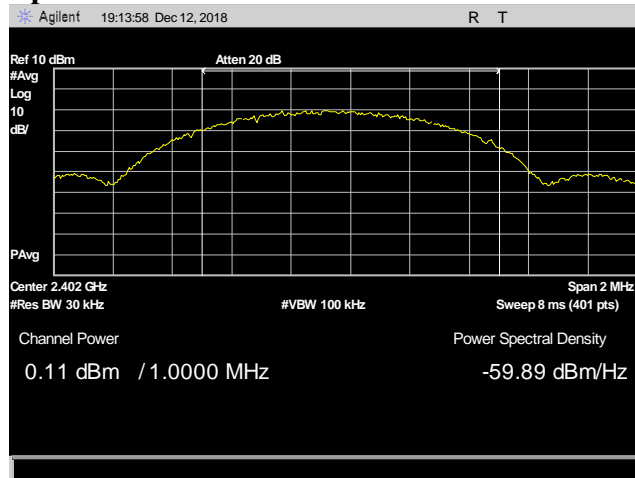

Plot 7. Maximum Conducted Output Power, 2402 MHz, Integrated Band Power

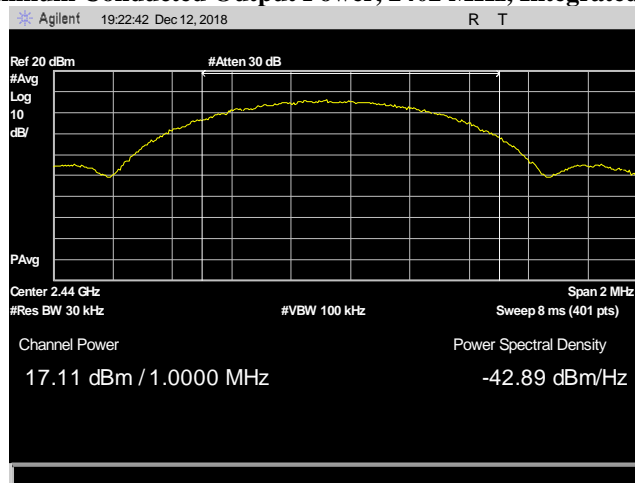

Plot 8. Maximum Conducted Output Power, 2440 MHz, Integrated Band Power

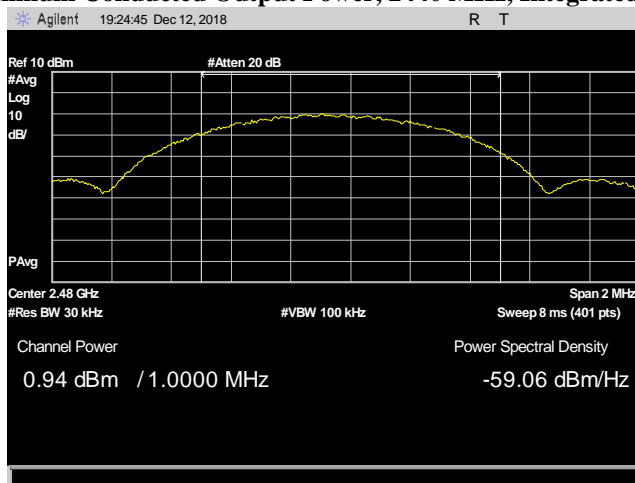

Plot 9. Maximum Conducted Output Power, 2480 MHz, Integrated Band Power

Electromagnetic Compatibility Criteria for Intentional Radiators

§ 15.209 Radiated Spurious Emissions Requirements and Band Edge

Test Requirements: §15.247(d); §15.205: Emissions outside the frequency band.

§15.205(a): Except as shown in paragraph (d) of this section, only spurious emissions are permitted in any of the frequency bands listed below:

MHz	MHz	MHz	GHz
0.090–0.110-----	16.42–16.423	399.9–410	4.5–5.15
¹ 0.495–0.505-----	16.69475–16.69525	608–614	5.35–5.46
2.1735–2.1905-----	16.80425–16.80475	960–1240	7.25–7.75
4.125–4.128-----	25.5–25.67	1300–1427	8.025–8.5
4.17725–4.17775-----	37.5–38.25	1435–1626.5	9.0–9.2
4.20725–4.20775-----	73–74.6	1645.5–1646.5	9.3–9.5
6.215–6.218-----	74.8–75.2	1660–1710	10.6–12.7
6.26775–6.26825-----	108–121.94	1718.8–1722.2	13.25–13.4
6.31175–6.31225-----	123–138	2200–2300	14.47–14.5
8.291–8.294-----	149.9–150.05	2310–2390	15.35–16.2
8.362–8.366-----	156.52475–156.52525	2483.5–2500	17.7–21.4
8.37625–8.38675-----	156.7–156.9	2655–2900	22.01–23.12
8.41425–8.41475-----	162.0125–167.17	3260–3267	23.6–24.0
12.29–12.293-----	167.72–173.2	3332–3339	31.2–31.8
12.51975–12.52025-----	240–285	3345.8–3358.36	43–36.5
12.57675–12.57725-----	322–335.4	3600–4400	(²)

Table 15. Restricted Bands of Operation

¹ Until February 1, 1999, this restricted band shall be 0.490 – 0.510 MHz.

² Above 38.6

Test Requirement(s): § 15.209 (a): Except as provided elsewhere in this subpart, the emissions from an intentional radiator shall not exceed the field strength levels specified in Table 16.

Frequency (MHz)	§ 15.209(a), Radiated Emission Limits (dBµV) @ 3m
30 - 88	40.00
88 - 216	43.50
216 - 960	46.00
Above 960	54.00

Table 16. Radiated Emissions Limits Calculated from FCC Part 15, § 15.209 (a)

Test Procedures: The transmitter was turned on. Measurements were performed of the low, mid and high Channels. The EUT was rotated orthogonally through all three axes. Plots shown are corrected for both antenna correction factor and distance and compared to a 3 m limit line. Only noise floor was measured above 18 GHz; however the worst-case emission profile is provided.

Test Results: The EUT was compliant with the Radiated Spurious Emission limits of § 15.247(d) and § 15.209. Measured emissions were within applicable limits.

Test Engineer(s): Jonathan Tavira

Test Date(s): September 4, 2018

Radiated Spurious Emissions, Test Results

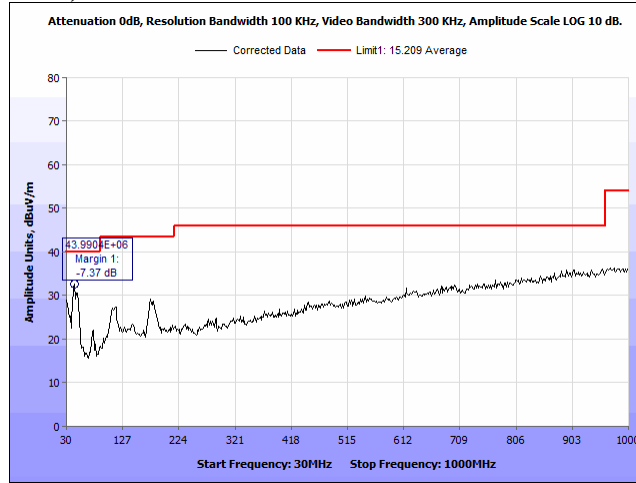

Plot 10. Radiated Emissions, 2402 MHz, 30 – 1000 MHz, Vertical

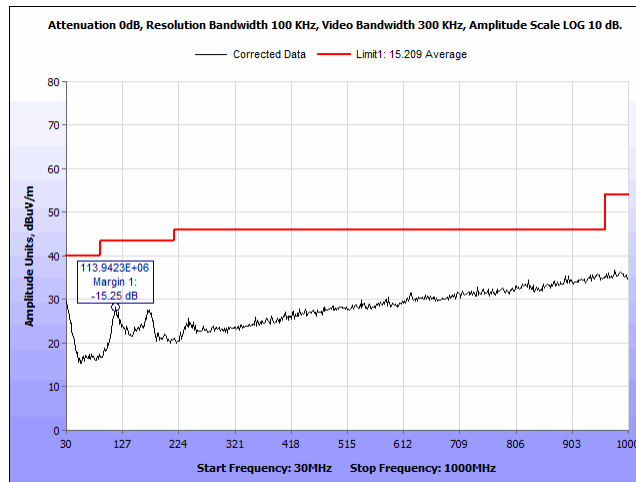

Plot 11. Radiated Emissions, 2402 MHz, 30 – 1000 MHz, Horizontal

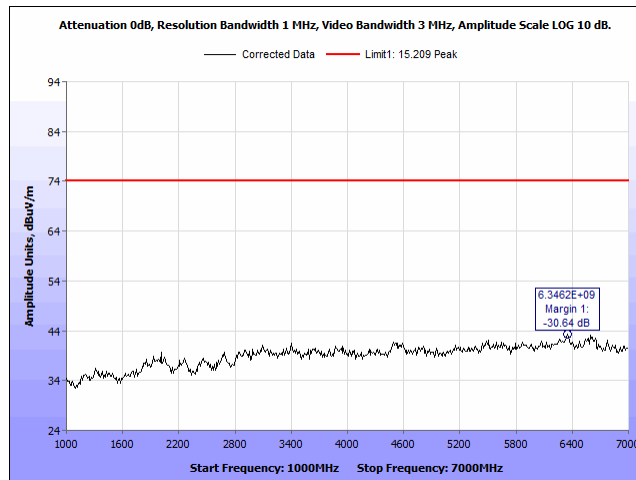

Plot 12. Radiated Emissions, 2402 MHz, 1 – 7 GHz, Peak, Vertical

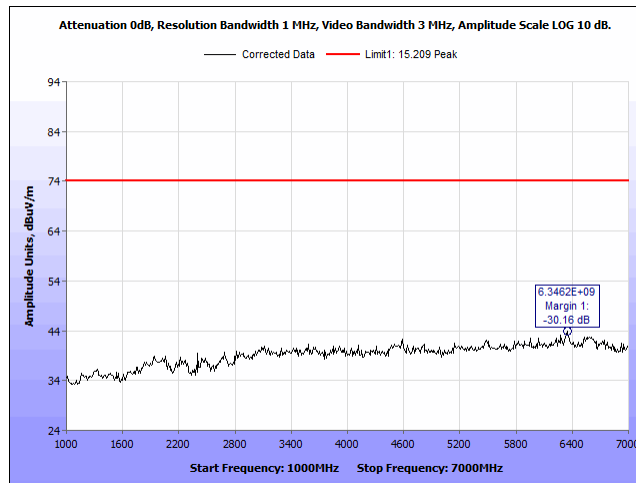

Plot 13. Radiated Emissions, 2402 MHz, 1 – 7 GHz, Peak, Horizontal

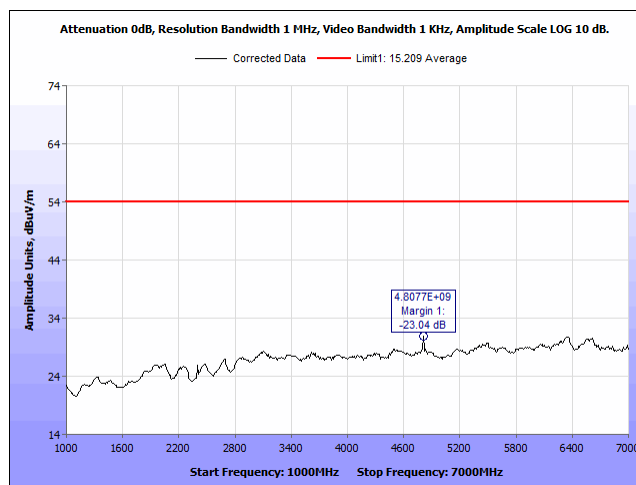

Plot 14. Radiated Emissions, 2402 MHz, 1 – 7 GHz, Average, Vertical

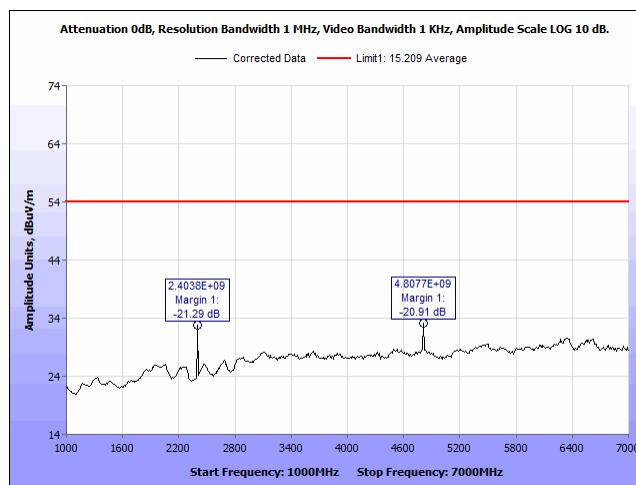

Plot 15. Radiated Emissions, 2402 MHz, 1 – 7 GHz, Average, Horizontal

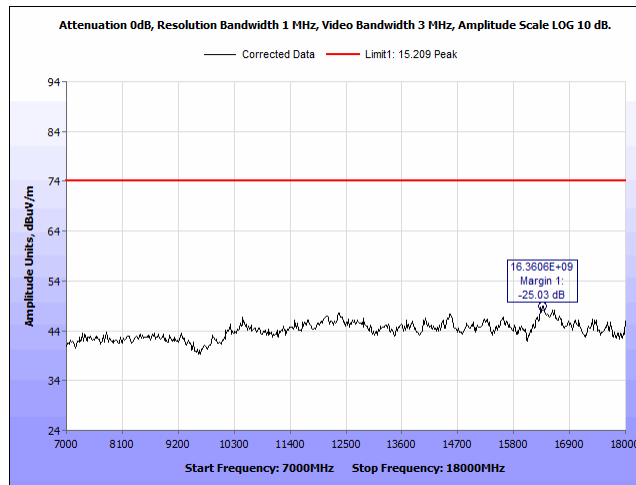

Plot 16. Radiated Emissions, 2402 MHz, 7 – 18 GHz, Peak, Vertical

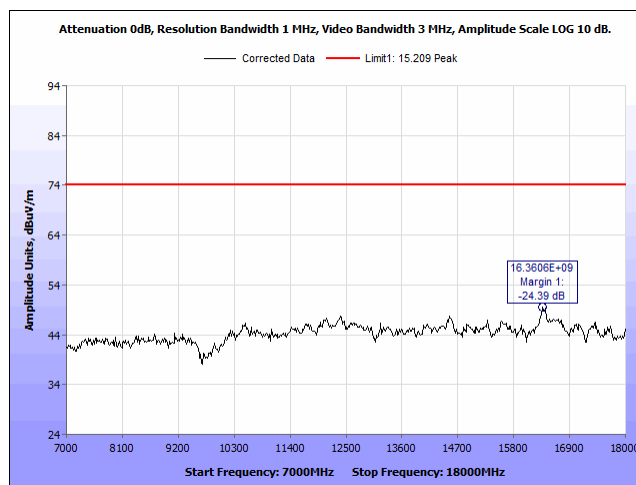

Plot 17. Radiated Emissions, 2402 MHz, 7 – 18 GHz, Peak, Horizontal

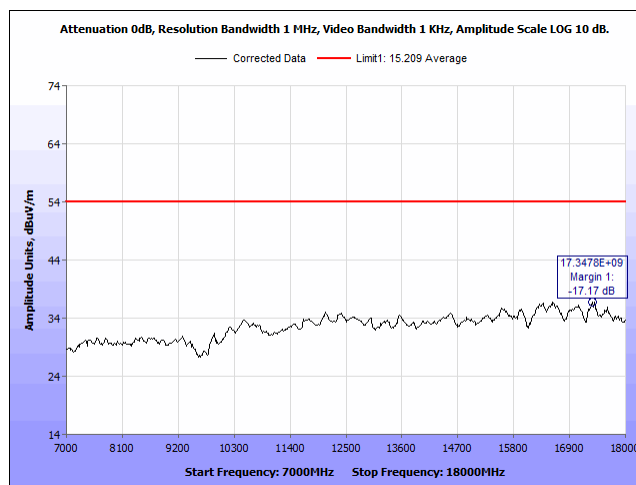

Plot 18. Radiated Emissions, 2402 MHz, 7 – 18 GHz, Average, Vertical

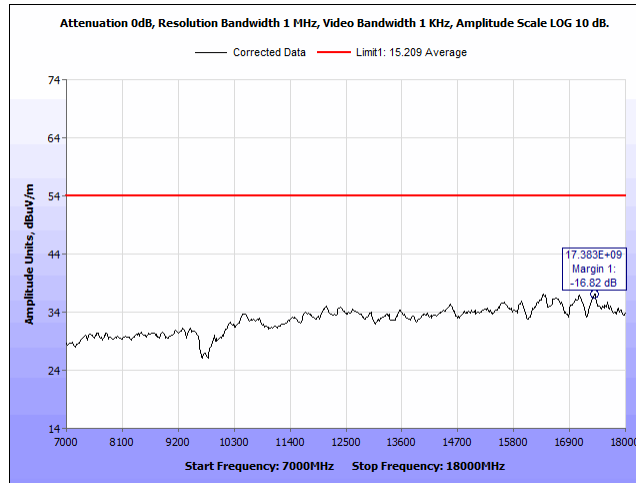

Plot 19. Radiated Emissions, 2402 MHz, 7 – 18 GHz, Average, Horizontal

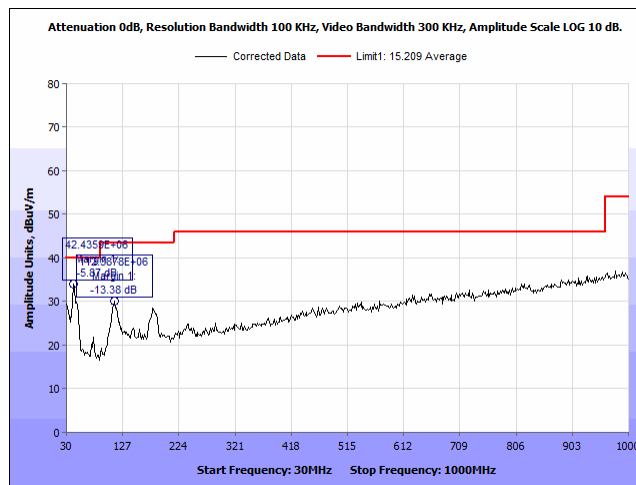

Plot 20. Radiated Emissions, 2440 MHz, 30 – 1000 MHz, Vertical

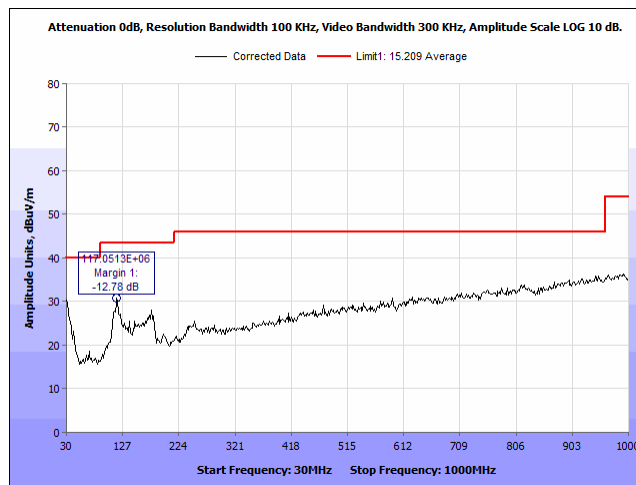

Plot 21. Radiated Emissions, 2440 MHz, 30 – 1000 MHz, Horizontal

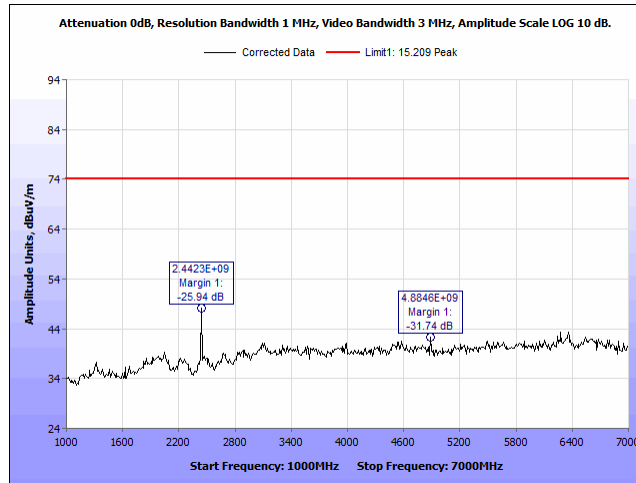

Plot 22. Radiated Emissions, 2440 MHz, 1 – 7 GHz, Peak, Vertical

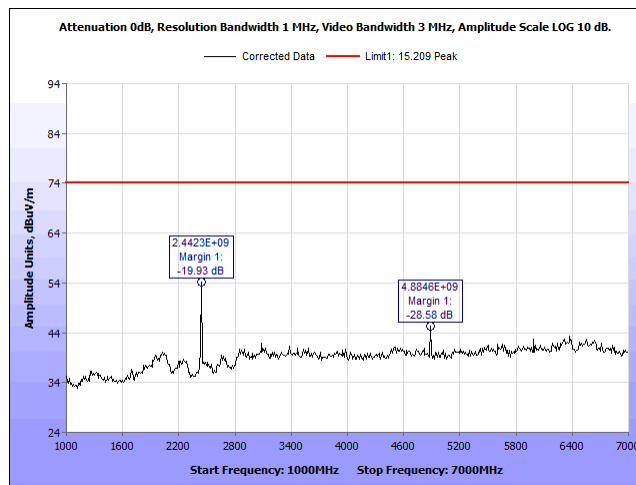

Plot 23. Radiated Emissions, 2440 MHz, 1 – 7 GHz, Peak, Horizontal

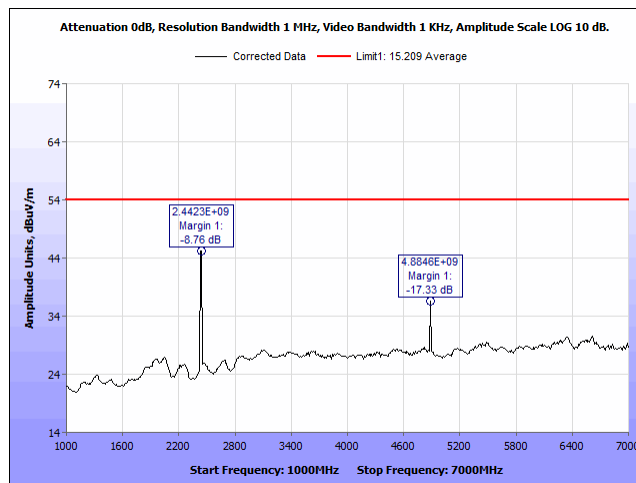

Plot 24. Radiated Emissions, 2440 MHz, 1 – 7 GHz, Average, Vertical

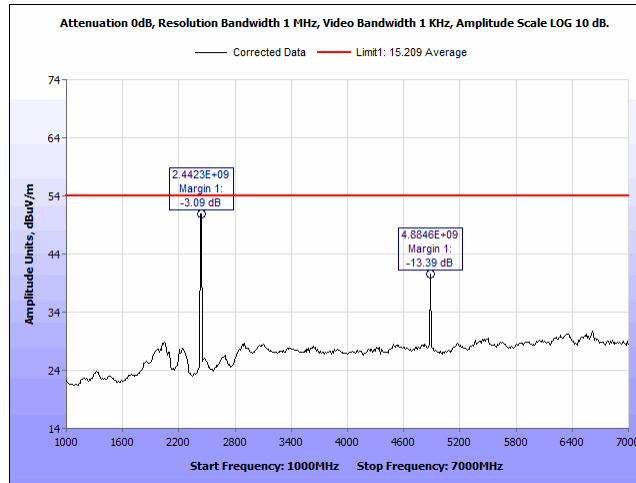

Plot 25. Radiated Emissions, 2440 MHz, 1 – 7 GHz, Average, Horizontal

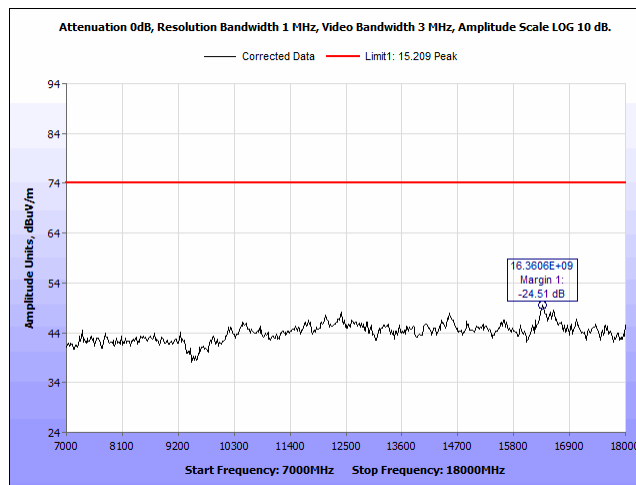

Plot 26. Radiated Emissions, 2440 MHz, 7 – 18 GHz, Peak, Vertical

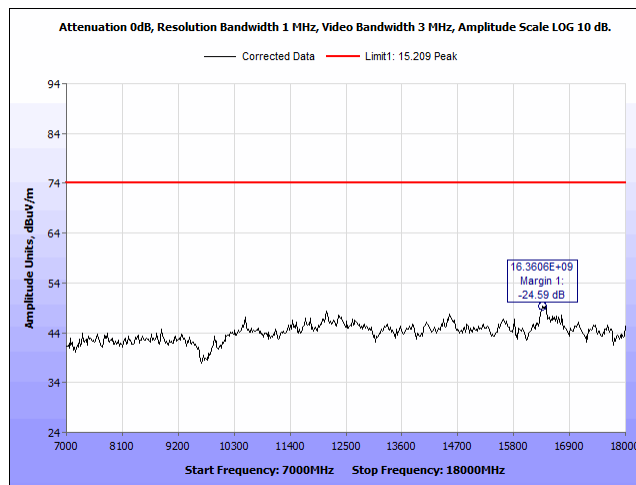

Plot 27. Radiated Emissions, 2440 MHz, 7 – 18 GHz, Peak, Horizontal

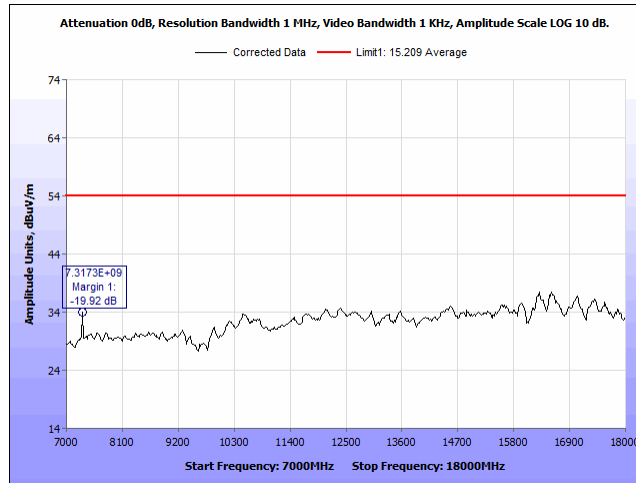

Plot 28. Radiated Emissions, 2440 MHz, 7 – 18 GHz, Average, Vertical

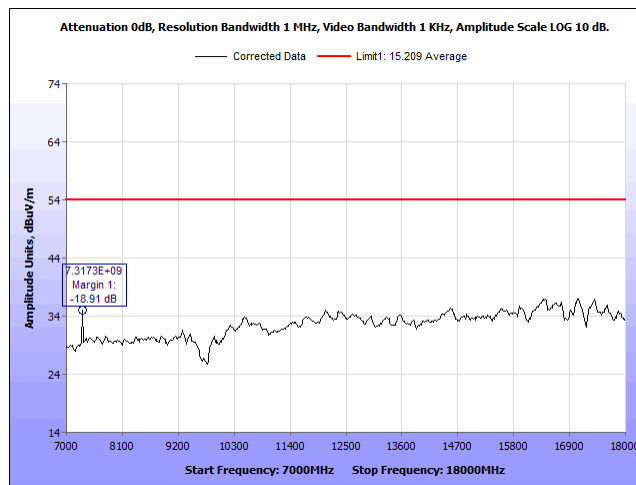

Plot 29. Radiated Emissions, 2440 MHz, 7 – 18 GHz, Average, Horizontal

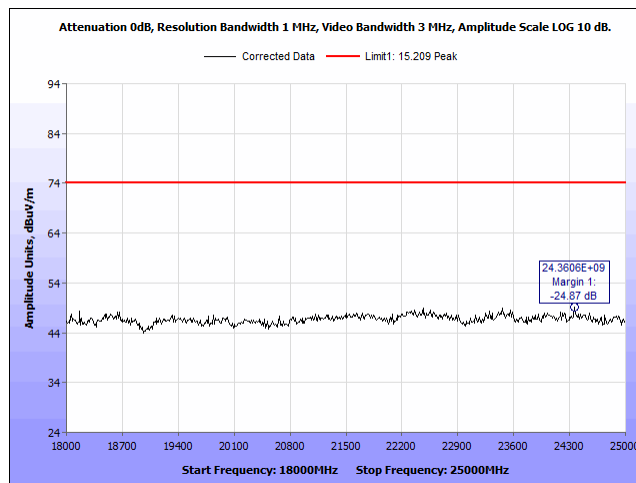

Plot 30. Radiated Emissions, 2440 MHz, 18 – 25 GHz, Peak, Vertical

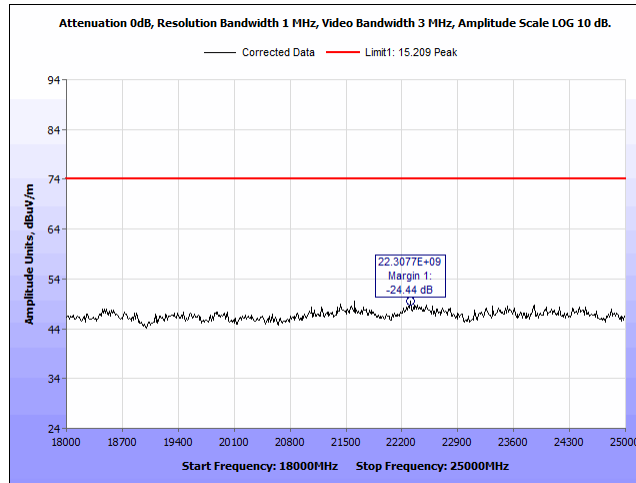

Plot 31. Radiated Emissions, 2440 MHz, 18 – 25 GHz, Peak, Horizontal

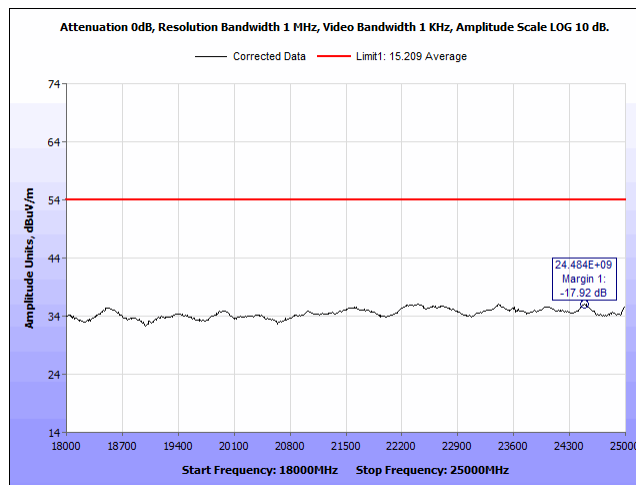

Plot 32. Radiated Emissions, 2440 MHz, 18 – 25 GHz, Average, Vertical

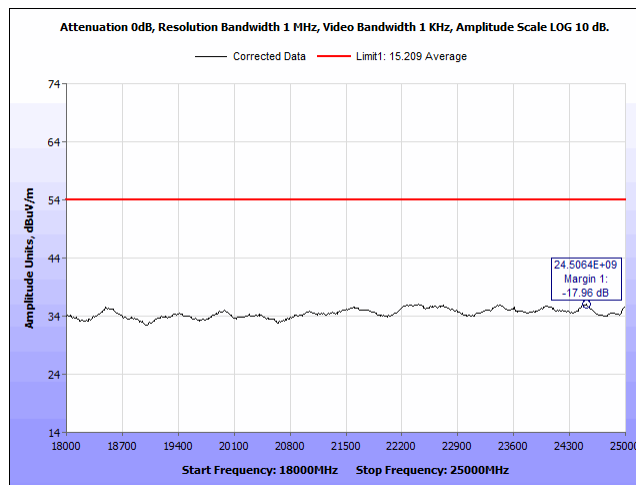

Plot 33. Radiated Emissions, 2440 MHz, 18 – 25 GHz, Average, Horizontal

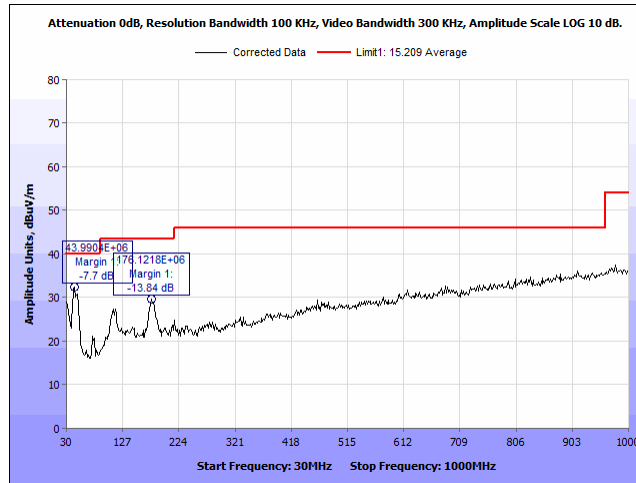

Plot 34. Radiated Emissions, 2480 MHz, 30 – 1000 MHz, Vertical

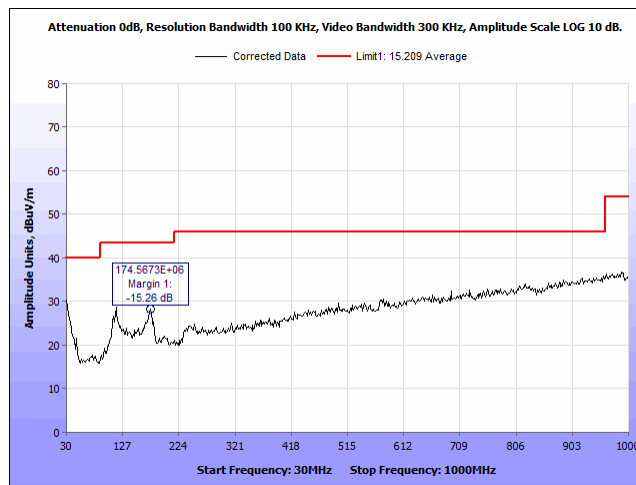

Plot 35. Radiated Emissions, 2480 MHz, 30 – 1000 MHz, Horizontal

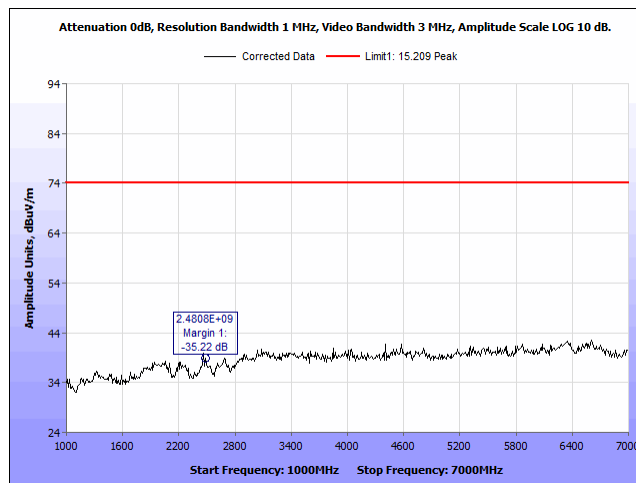

Plot 36. Radiated Emissions, 2480 MHz, 1 – 7 GHz, Peak, Vertical

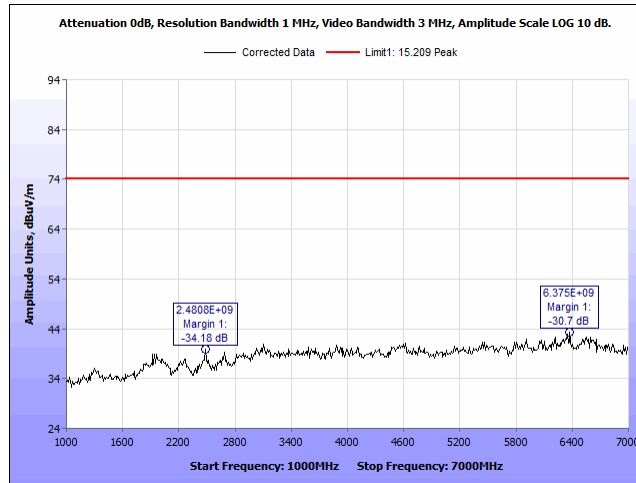

Plot 37. Radiated Emissions, 2480 MHz, 1 – 7 GHz, Peak, Horizontal

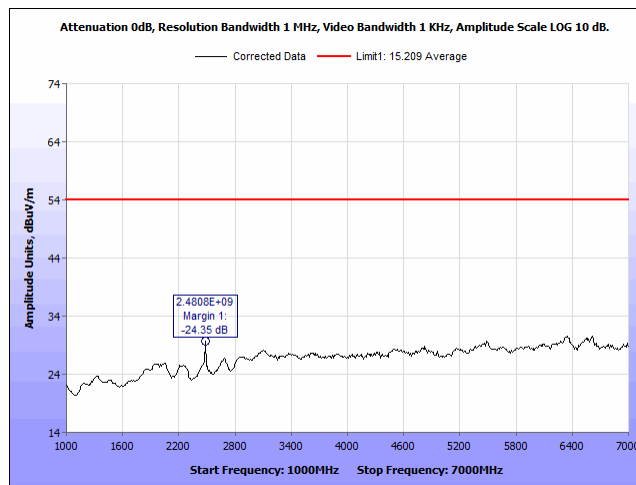

Plot 38. Radiated Emissions, 2480 MHz, 1 – 7 GHz, Average, Vertical

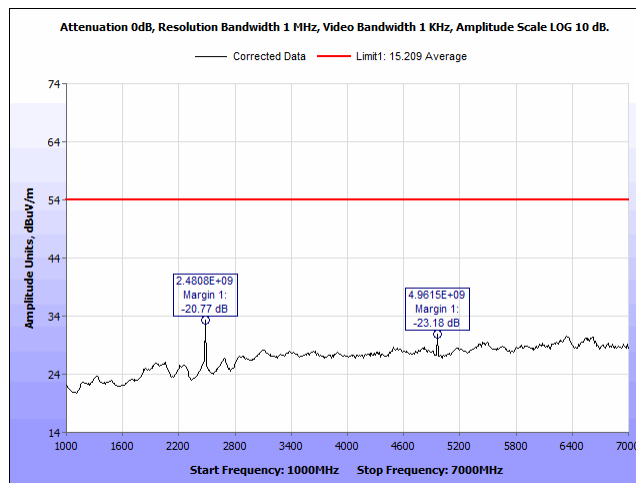

Plot 39. Radiated Emissions, 2480 MHz, 1 – 7 GHz, Average, Horizontal

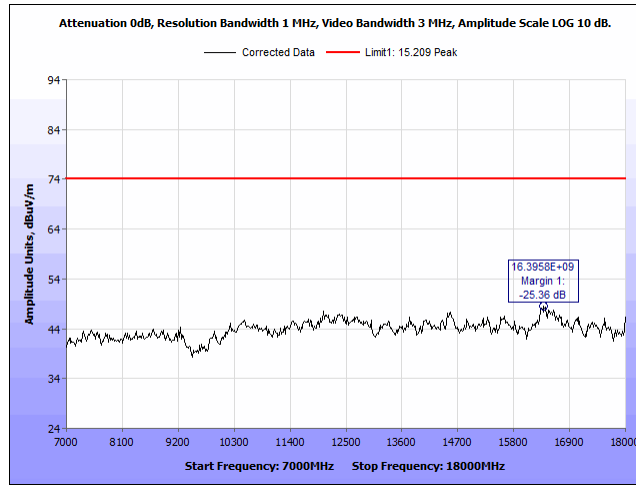

Plot 40. Radiated Emissions, 2480 MHz, 7 – 18 GHz, Peak, Vertical

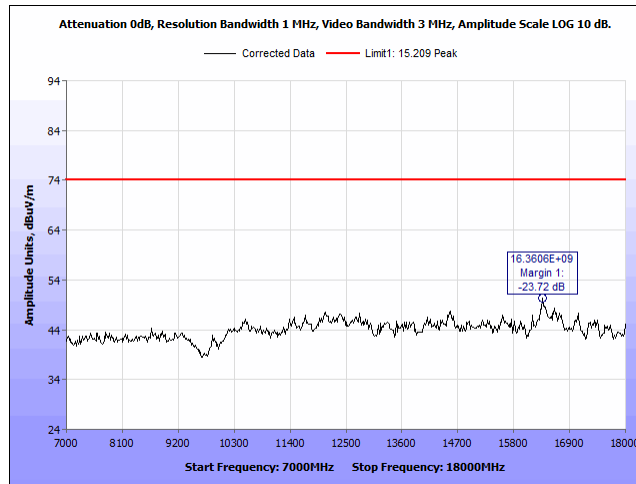

Plot 41. Radiated Emissions, 2480 MHz, 7 – 18 GHz, Peak, Horizontal

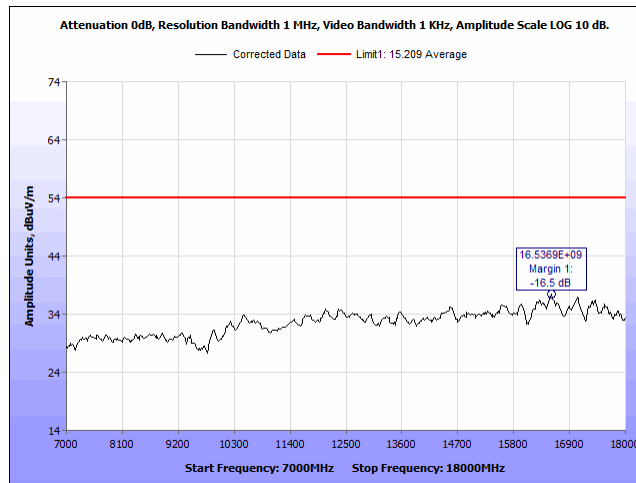

Plot 42. Radiated Emissions, 2480 MHz, 7 – 18 GHz, Average, Vertical

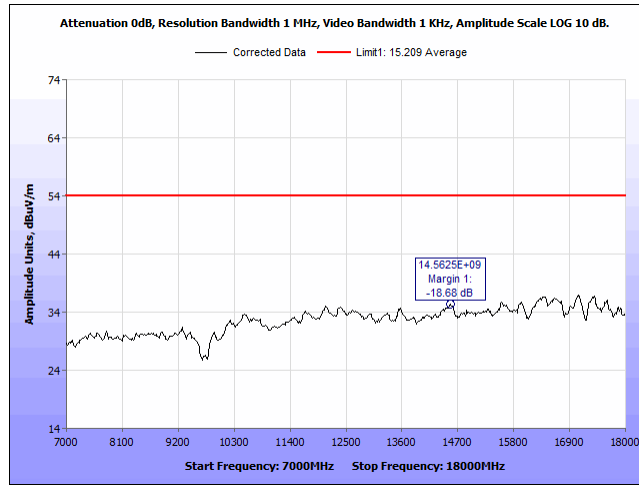

Plot 43. Radiated Emissions, 2480 MHz, 7 – 18 GHz, Average, Horizontal

Radiated Band Edge Measurements

Test Procedures:

The transmitter was turned on. Measurements were performed of the low and high Channels. The EUT was rotated orthogonally through all three axes. Plots shown are corrected for both antenna correction factor and distance and compared to a 3 m limit line.

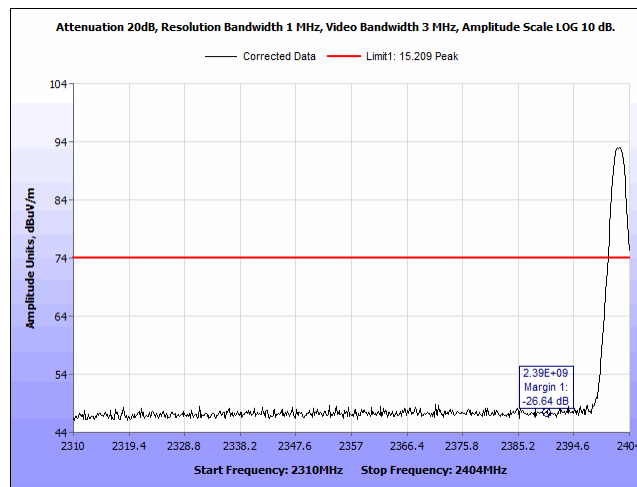

Plot 44. Radiated Restricted Bandedge, 2402 MHz, Peak, Vertical

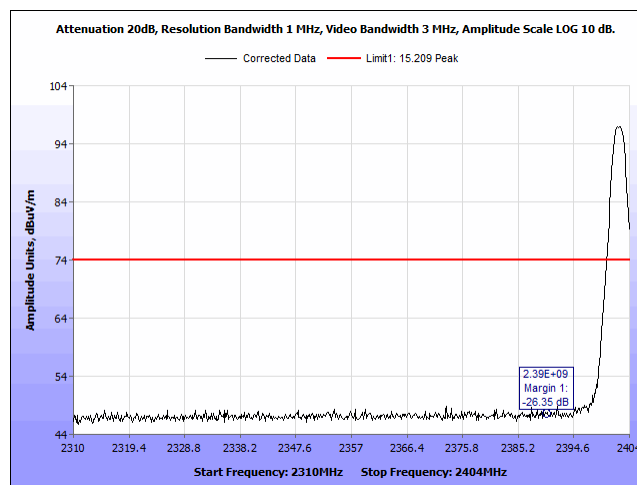

Plot 45. Radiated Restricted Bandedge, 2402 MHz, Peak, Horizontal

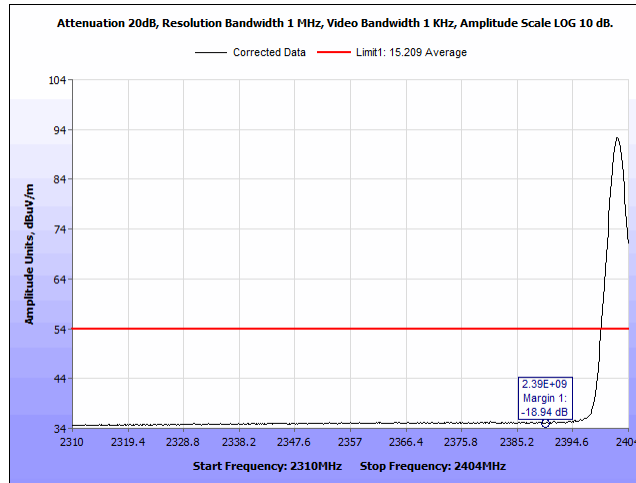

Plot 46. Radiated Restricted Bandedge, 2402 MHz, Average, Vertical

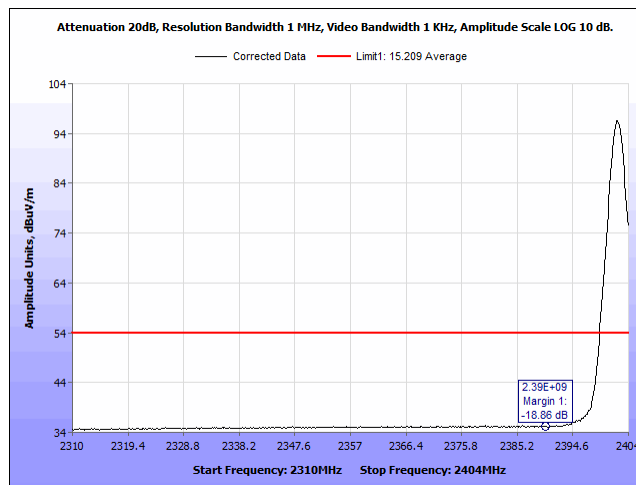

Plot 47. Radiated Restricted Bandedge, 2402 MHz, Average, Horizontal

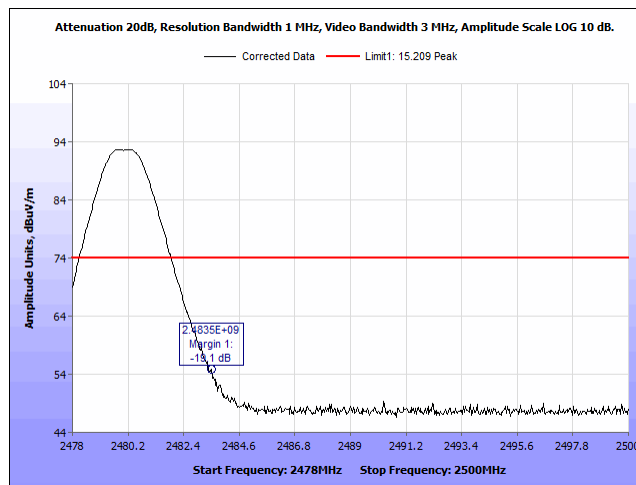

Plot 48. Radiated Restricted Bandedge, 2480 MHz, Peak, Vertical

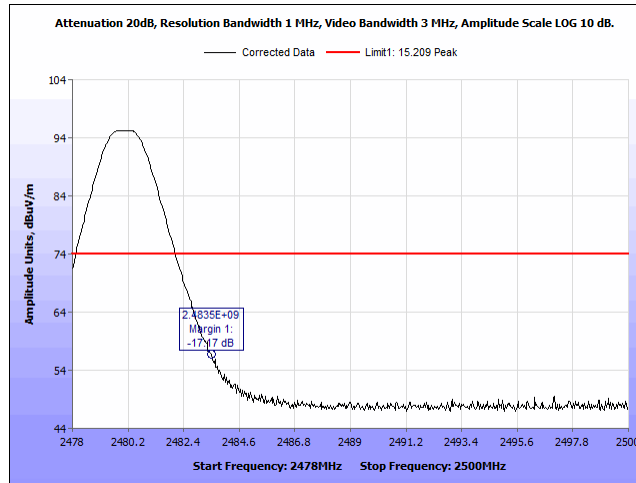

Plot 49. Radiated Restricted Bandedge, 2480 MHz, Peak, Horizontal

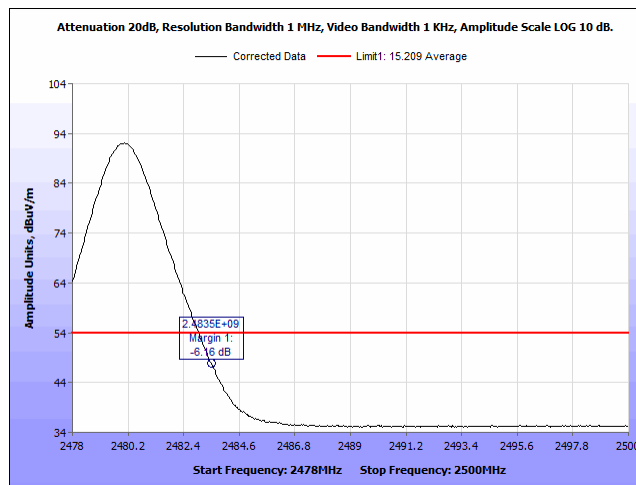

Plot 50. Radiated Restricted Bandedge, 2480 MHz, Average, Vertical

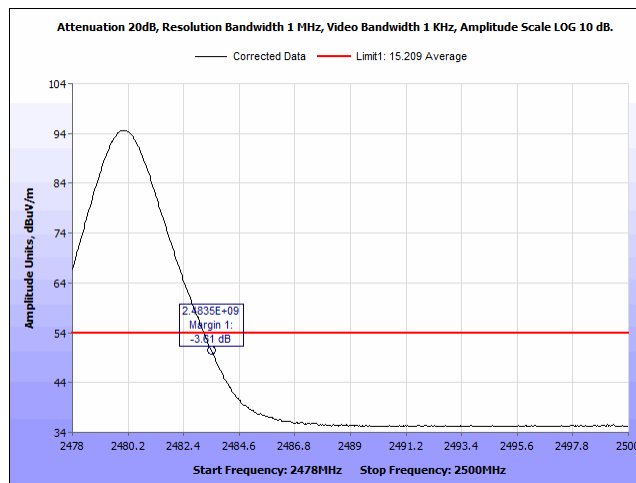

Plot 51. Radiated Restricted Bandedge, 2480 MHz, Average, Horizontal

Electromagnetic Compatibility Criteria for Intentional Radiators

§ 15.247(d) Spurious Emissions in Non-restricted Bands

Test Requirement: **15.247(d)** In any 100 kHz bandwidth outside the frequency band in which the spread spectrum or digitally modulated intentional radiator is operating, the radio frequency power that is produced by the intentional radiator shall be at least 20 dB below that in the 100 kHz bandwidth within the band that contains the highest level of the desired power, based on either an RF conducted or a radiated measurement, provided the transmitter demonstrates compliance with the peak conducted power limits. If the transmitter complies with the conducted power limits based on the use of RMS averaging over a time interval, as permitted under paragraph (b)(3) of this section, the attenuation required under this paragraph shall be 30 dB instead of 20 dB.

Test Procedure: For intentional radiators with a digital device portion which operates below 10 GHz, the spectrum was investigated as per §15.33(a)(1) and §15.33(a)(4); i.e., the lowest RF signal generated or used in the device up to the 10th harmonic of the highest fundamental frequency or to 40 GHz, whichever is lower.

Test Results: The EUT was compliant with the Spurious Emission limits of **§15.247(d)**. Measured emissions were within applicable limits.

Test Engineer(s): Jonathan Tavira

Test Date(s): December 12, 2018

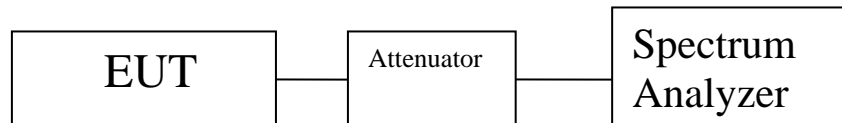
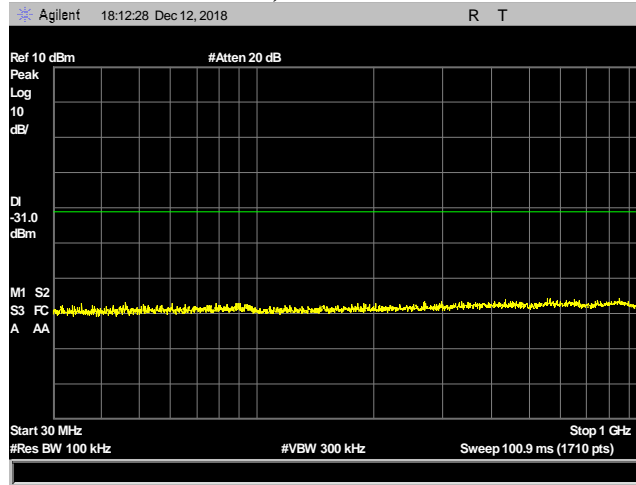
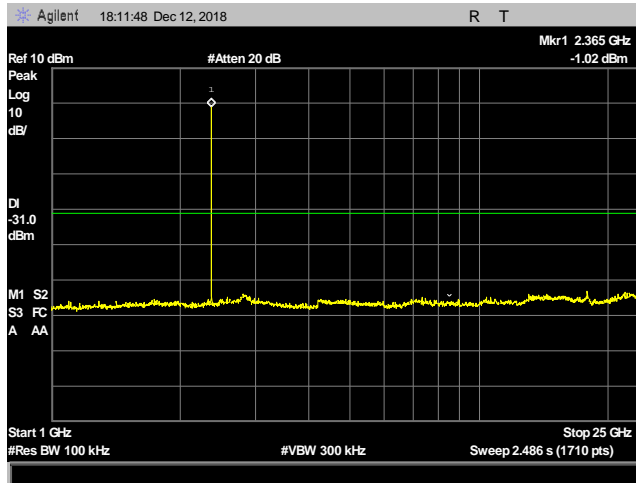

Figure 4. Spurious Emission in Non-restricted Bands, Block Diagram of Test Setup

Spurious Emissions in Non-restricted Bands, Test Results



Plot 52. 100 kHz Spurious Emissions, 2402 MHz, 30 – 1000 MHz



Plot 53. 100 kHz Spurious Emissions, 2402 MHz, 1 – 25 GHz

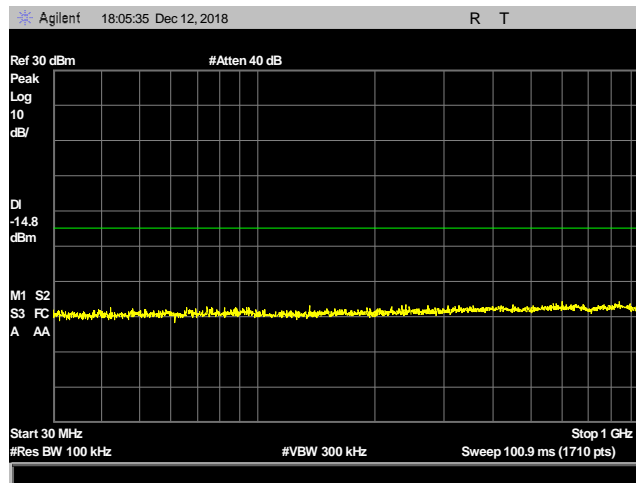

Plot 54. 100 kHz Spurious Emissions, 2440 MHz, 30 – 1000 MHz

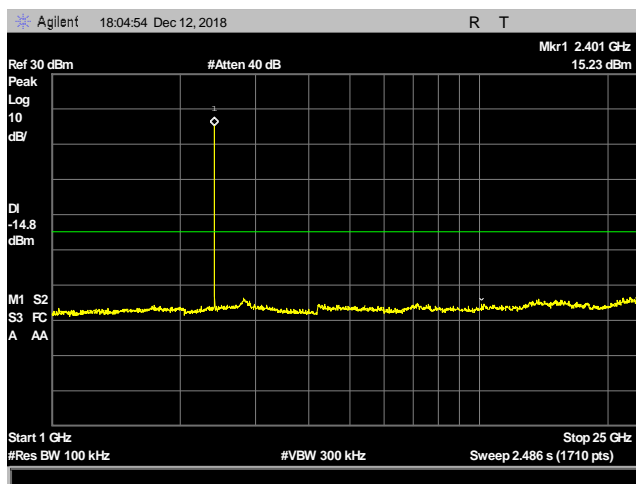

Plot 55. 100 kHz Spurious Emissions, 2440 MHz, 1 – 25 GHz

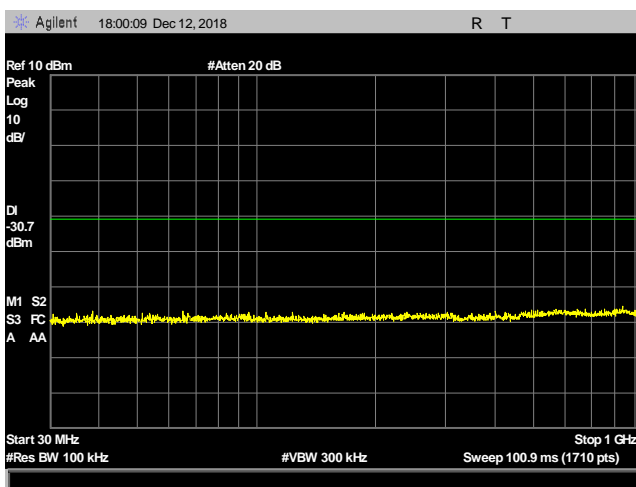

Plot 56. 100 kHz Spurious Emissions, 2480 MHz, 30 -1000 MHz

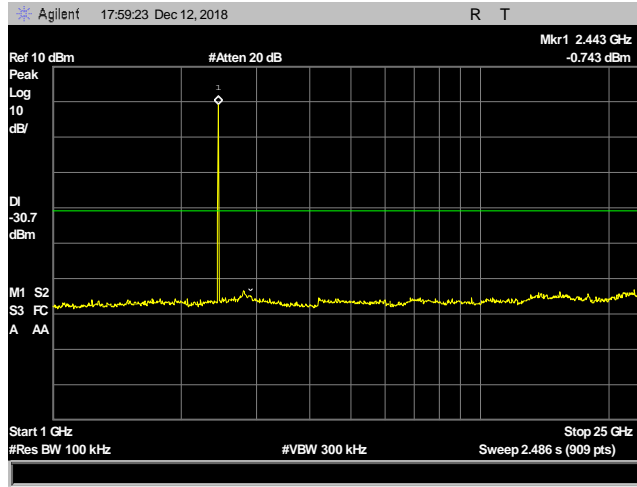

Plot 57. 100 kHz Spurious Emissions, 2480 MHz, 1- 25 GHz

Conducted Band Edge

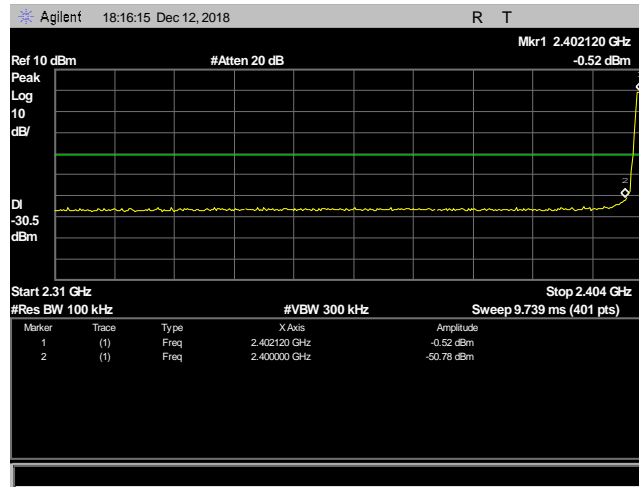

Plot 58. Conducted Bandedge, 2402 MHz

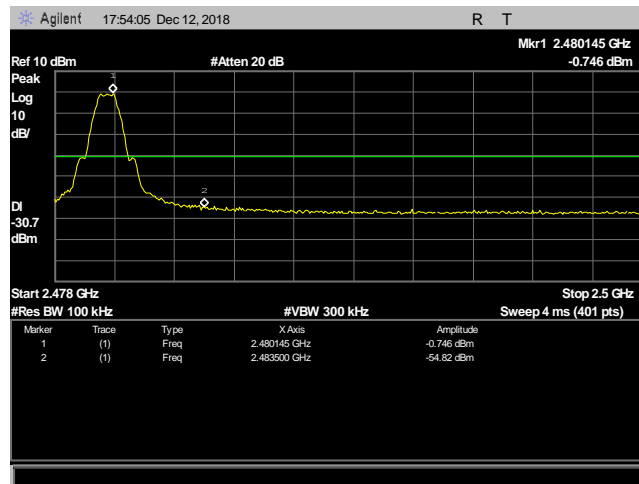

Plot 59. Conducted Bandedge, 2480 MHz

Electromagnetic Compatibility Criteria for Intentional Radiators

§ 15.247(e) Power Spectral Density

Test Requirements: §15.247(e): For digitally modulated systems, the peak power spectral density conducted from the intentional radiator to the antenna shall not be greater than 8dBm in any 3 kHz band during any time interval of continuous transmission.

Test Procedure: The power level was set to the maximum level throughout each of the 100 sweeps of power averaging. The RBW was set to $3 \text{ kHz} \leq \text{RBW} \leq 100 \text{ kHz}$ and a VBW set to three times the RBW or greater. The spectrum analyzer was set to an auto sweep time and a peak detector was used. Measurements were carried out at the low, mid and high channels

Test Results: The EUT was compliant with the power spectral density limits of § 15.247 (e). No anomalies detected.

The power spectral density was determined from plots on the following page(s).

Test Engineer: Jonathan Tavira

Test Date: December 12, 2018

Peak Power Spectral Density Test Results

Power Spectral Density		
Carrier Channel	Frequency (MHz)	Average Conducted PSD (dBm)
Low	2402	-5.137
Mid	2440	5.265
High	2480	-5.476

Table 17. Power Spectral Density, Test Results

Peak Power Spectral Density

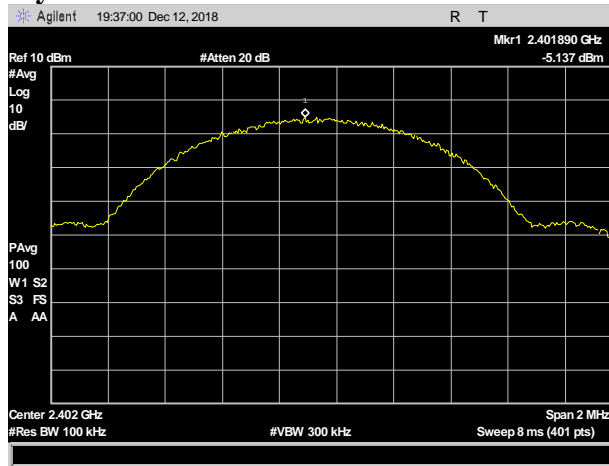

Plot 60. Power Density, 2402 MHz, 100 kHz RBW

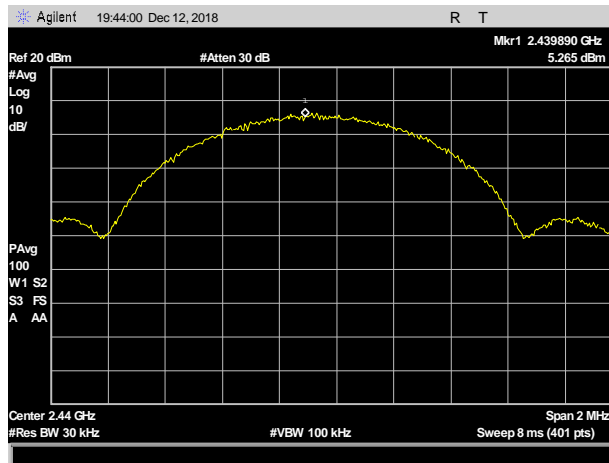

Plot 61. Power Density, 2440 MHz, 30 kHz RBW

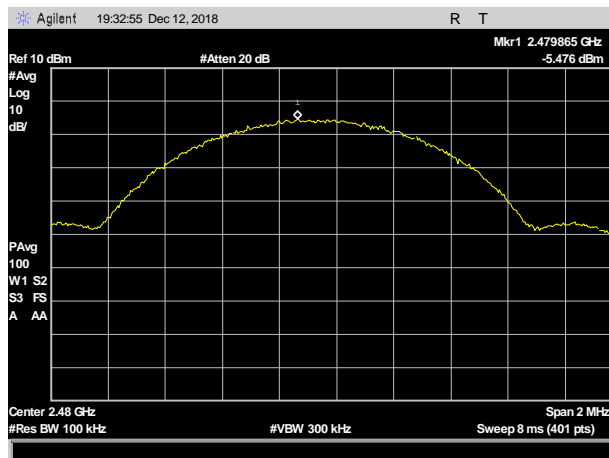

Plot 62. Power Density, 2480 MHz, 100 kHz

Electromagnetic Compatibility Criteria for Intentional Radiators

§ 15.247(i) Maximum Permissible Exposure

RF Exposure Requirements: §1.1307(b)(1) and §1.1307(b)(2): Systems operating under the provisions of this section shall be operated in a manner that ensures that the public is not exposed to radio frequency energy levels in excess of the Commission’s guidelines.

RF Radiation Exposure Limit: §1.1310: As specified in this section, the Maximum Permissible Exposure (MPE) Limit shall be used to evaluate the environmental impact of human exposure to radiofrequency (RF) radiation as specified in Sec. 1.1307(b), except in the case of portable devices which shall be evaluated according to the provisions of Sec. 2.1093 of this chapter.

MPE Limit: EUT’s operating frequencies @ 2400-2483.5 MHz; **Limit for Uncontrolled exposure: 1 mW/cm² or 10 W/m²**

Equation from page 18 of OET 65, Edition 97-01

$$S = PG / 4\pi R^2 \quad \text{or} \quad R = \sqrt{PG / 4\pi S}$$

where, S = Power Density (mW/cm²)
P = Power Input to antenna (mW)
G = Antenna Gain (numeric value)
R = Distance (cm)

Test Results:

FCC									
Frequency (MHz)	Con. Pwr. (dBm)	Con. Pwr. (mW)	Ant. Gain (dBi)	Ant. Gain numeric	Pwr. Density (mW/cm ²)	Limit (mW/cm ²)	Margin	Distance (cm)	Result
2440	17.11	51.404	-3	0.501	0.00513	1	0.99487	20	Pass

The safe distance where Power Density is less than the MPE Limit listed above was found to be 20 cm.

IV. Test Equipment

Test Equipment

Calibrated test equipment utilized during testing was maintained in a current state of calibration per the requirements of ISO/IEC 17025:2005.

MET Asset #	Equipment	Manufacturer	Model	Last Cal Date	Cal Due Date
1A1083	EMI TEST RECEIVER	ROHDE & SCHWARZ	ESU40	9/12/2017	10/12/2018
1A1184	SPECTRUM ANALYZER	AGILENT	E4407B	4/20/2018	4/20/2019
1A1106	10M CHAMBER (FCC)	ETS	SEMI-ANECHOIC	SEE NOTE	
1A1147	BILOG ANTENNA (30MHZ TO 1GHZ)	SUNOL SCIENCES CORP	JB3	9/21/2017	3/21/2019
1A1047	DOUBLE RIDGED WAVE GUIDE HORN ANTENNA	ETS	3117	2/23/2017	11/8/2018
1A1161	DOUBLE RIDGED WAVE GUIDE HORN ANTENNA	ETS	3116C-PA	3/6/2017	9/6/2018
1A1099	GENERATOR	COM-POWER CORP	CGO-51000	SEE NOTE	
1A1088	PRE-AMP	ROHDE & SCHWARZ	TS-PR1	SEE NOTE	
1A1044	GENERATOR	COM-POWER CORP	CG-520	SEE NOTE	
1A1073	MULTI DEVICE CONTROLLER	ETS EMCO	2090	SEE NOTE	
1A1074	SYSTEM CONTROLLER	PANASONIC	WV-CU101	SEE NOTE	
1A1075	SYSTEM CONTROLLER	PANASONIC	WV-CU101	SEE NOTE	
1A1080	MULTI DEVICE CONTROLLER	ETS EMCO	2090	SEE NOTE	
1A1180	PRE-AMP	MITEQ	AMF-7D-01001800-22-10P	SEE NOTE	

Table 18. Test Equipment List

Note: Functionally tested equipment is verified using calibrated instrumentation at the time of testing.

V. Certification & User's Manual Information

Certification & User's Manual Information

A. Certification Information

The following is extracted from Title 47 of the Code of Federal Regulations, Part 2, Subpart I — Marketing of Radio frequency devices:

§ 2.801 Radio-frequency device defined.

As used in this part, a radio-frequency device is any device which in its operation is capable of Emitting radio-frequency energy by radiation, conduction, or other means. Radio- frequency devices include, but are not limited to:

- (a) The various types of radio communication transmitting devices described throughout this chapter.
- (b) *The incidental, unintentional and intentional radiators defined in Part 15 of this chapter.*
- (c) The industrial, scientific, and medical equipment described in Part 18 of this chapter.
- (d) Any part or component thereof which in use emits radio-frequency energy by radiation, conduction, or other means.

§ 2.803 Marketing of radio frequency devices prior to equipment authorization.

- (a) Except as provided elsewhere in this chapter, no person shall sell or lease, or offer for sale or lease (including advertising for sale or lease), or import, ship or distribute for the purpose of selling or leasing or offering for sale or lease, any radio frequency device unless:
 - (1) In the case of a device subject to certification, such device has been authorized by the Commission in accordance with the rules in this chapter and is properly identified and labeled as required by §2.925 and other relevant sections in this chapter; or
 - (2) In the case of a device that is not required to have a grant of equipment authorization issued by the Commission, but which must comply with the specified technical standards prior to use, such device also complies with all applicable administrative (including verification of the equipment or authorization under a Declaration of Conformity, where required), technical, labeling and identification requirements specified in this chapter.
- (d) Notwithstanding the provisions of paragraph (a) of this section, the offer for sale solely to business, commercial, industrial, scientific or medical users (but not an offer for sale to other parties or to end users located in a residential environment) of a radio frequency device that is in the conceptual, developmental, design or pre-production stage is permitted prior to equipment authorization or, for devices not subject to the equipment authorization requirements, prior to a determination of compliance with the applicable technical requirements *provided* that the prospective buyer is advised in writing at the time of the offer for sale that the equipment is subject to the FCC rules and that the equipment will comply with the appropriate rules before delivery to the buyer or to centers of distribution.

- (e)(1) Notwithstanding the provisions of paragraph (a) of this section, prior to equipment authorization or determination of compliance with the applicable technical requirements any radio frequency device may be operated, but not marketed, for the following purposes and under the following conditions:
- (i) *Compliance testing*;
 - (ii) Demonstrations at a trade show provided the notice contained in paragraph (c) of this section is displayed in a conspicuous location on, or immediately adjacent to, the device;
 - (iii) Demonstrations at an exhibition conducted at a business, commercial, industrial, scientific or medical location, but excluding locations in a residential environment, provided the notice contained in paragraphs (c) or (d) of this section, as appropriate, is displayed in a conspicuous location on, or immediately adjacent to, the device;
 - (iv) Evaluation of product performance and determination of customer acceptability, provided such operation takes place at the manufacturer's facilities during developmental, design or pre-production states; or
 - (v) Evaluation of product performance and determination of customer acceptability where customer acceptability of a radio frequency device cannot be determined at the manufacturer's facilities because of size or unique capability of the device, provided the device is operated at a business, commercial, industrial, scientific or medical user's site, but not at a residential site, during the development, design or pre-production stages.
- (e)(2) For the purpose of paragraphs (e)(1)(iv) and (e)(1)(v) of this section, the term *manufacturer's facilities* includes the facilities of the party responsible for compliance with the regulations and the manufacturer's premises, as well as the facilities of other entities working under the authorization of the responsible party in connection with the development and manufacture, but not the marketing, of the equipment.
- (f) For radio frequency devices subject to verification and sold solely to business, commercial, industrial, scientific and medical users (excluding products sold to other parties or for operation in a residential environment), parties responsible for verification of the devices shall have the option of ensuring compliance with the applicable technical specifications of this chapter at each end user's location after installation, provided that the purchase or lease agreement includes a proviso that such a determination of compliance be made and is the responsibility of the party responsible for verification of the equipment.

Certification & User's Manual Information

The following is extracted from Title 47 of the Code of Federal Regulations, Part 2, Subpart J — Equipment Authorization Procedures:

§ 2.901 Basis and Purpose

- (a) In order to carry out its responsibilities under the Communications Act and the various treaties and international regulations, and in order to promote efficient use of the radio spectrum, the Commission has developed technical standards for radio frequency equipment and parts or components thereof. The technical standards applicable to individual types of equipment are found in that part of the rules governing the service wherein the equipment is to be operated.¹ *In addition to the technical standards provided, the rules governing the service may require that such equipment be verified by the manufacturer or importer, be authorized under a Declaration of Conformity, or receive an equipment authorization from the Commission by one of the following procedures: certification or registration.*
- (b) The following sections describe the verification procedure, the procedure for a Declaration of Conformity, and the procedures to be followed in obtaining certification from the Commission and the conditions attendant to such a grant.

§ 2.907 Certification.

- (a) Certification is an equipment authorization issued by the Commission, based on representation and test data submitted by the applicant.
- (b) Certification attaches to all units subsequently marketed by the grantee which are identical (see Section 2.908) to the sample tested except for permissive changes or other variations authorized by the Commission pursuant to Section 2.1043.

¹ In this case, the equipment is subject to the rules of Part 15. More specifically, the equipment falls under Subpart B (of Part 15), which deals with unintentional radiators.

Certification & User's Manual Information

§ 2.948 Description of measurement facilities.

- (a) Each party making measurements of equipment that is subject to an equipment authorization under Part 15 or Part 18 of this chapter, regardless of whether the measurements are filed with the Commission or kept on file by the party responsible for compliance of equipment marketed within the U.S. or its possessions, shall compile a description of the measurement facilities employed.
- (1) If the measured equipment is subject to the verification procedure, the description of the measurement facilities shall be retained by the party responsible for verification of the equipment.
- (i) *If the equipment is verified through measurements performed by an independent laboratory, it is acceptable for the party responsible for verification of the equipment to rely upon the description of the measurement facilities retained by or placed on file with the Commission by that laboratory. In this situation, the party responsible for the verification of the equipment is not required to retain a duplicate copy of the description of the measurement facilities.*
- (ii) If the equipment is verified based on measurements performed at the installation site of the equipment, no specific site calibration data is required. It is acceptable to retain the description of the measurement facilities at the site at which the measurements were performed.
- (2) If the equipment is to be authorized by the Commission under the certification procedure, the description of the measurement facilities shall be filed with the Commission's Laboratory in Columbia, Maryland. The data describing the measurement facilities need only be filed once but must be updated as changes are made to the measurement facilities or as otherwise described in this section. At least every three years, the organization responsible for filing the data with the Commission shall certify that the data on file is current.

Certification & User's Manual Information

1. Label and User's Manual Information

The following is extracted from Title 47 of the Code of Federal Regulations, Part 15, Subpart A — General:

§ 15.19 Labeling requirements.

(a) *In addition to the requirements in Part 2 of this chapter, a device subject to certification or verification shall be labeled as follows:*

- (1) Receivers associated with the operation of a licensed radio service, e.g., FM broadcast under Part 73 of this chapter, land mobile operation under Part 90, etc., shall bear the following statement in a conspicuous location on the device:

This device complies with Part 15 of the FCC Rules. Operation is subject to the condition that this device does not cause harmful interference.

- (2) A stand-alone cable input selector switch, shall bear the following statement in a conspicuous location on the device:

This device is verified to comply with Part 15 of the FCC Rules for use with cable television service.

- (3) All other devices shall bear the following statement in a conspicuous location on the device:

This device complies with Part 15 of the FCC Rules. Operation is subject to the following two conditions: (1) This device may not cause harmful interference, and (2) this device must accept any interference received, including interference that may cause undesired operation.

- (4) Where a device is constructed in two or more sections connected by wires and marketed together, the statement specified under paragraph (a) of this section is required to be affixed only to the main control unit.

- (5) When the device is so small or for such use that it is not practicable to place the statement specified under paragraph (a) of this section on it, the information required by this paragraph shall be placed in a prominent location in the instruction manual or pamphlet supplied to the user or, alternatively, shall be placed on the container in which the device is marketed. However, the FCC identifier or the unique identifier, as appropriate, must be displayed on the device.

§ 15.21 Information to user.

The user's manual or instruction manual for an intentional or unintentional radiator shall caution the user that changes or modifications not expressly approved by the party responsible for compliance could void the user's authority to operate the equipment.

Verification & User's Manual Information

The following is extracted from Title 47 of the Code of Federal Regulations, Part 15, Subpart B — Unintentional Radiators:

§ 15.105 Information to the user.

- (a) For a Class A digital device or peripheral, the instructions furnished the user shall include the following or similar statement, placed in a prominent location in the text of the manual:

Note: This equipment has been tested and found to comply with the limits for a Class A digital device, pursuant to Part 15 of the FCC Rules. These limits are designed to provide reasonable protection against harmful interference when the equipment is operated in a commercial environment. This equipment generates, uses, and can radiate radio frequency energy and, if not installed and used in accordance with the instruction manual, may cause harmful interference to radio communications. Operation of this equipment in a residential area is likely to cause harmful interference in which case the user will be required to correct the interference at own expense.

- (b) For a Class B digital device or peripheral, the instructions furnished the user shall include the following or similar statement, placed in a prominent location in the text of the manual:

Note: This equipment has been tested and found to comply with the limits for a Class B digital device, pursuant to Part 15 of the FCC Rules. These limits are designed to provide reasonable protection against harmful interference when the equipment is operated in a residential environment. This equipment generates, uses, and can radiate radio frequency energy and, if not installed and used in accordance with the instruction manual, may cause harmful interference to radio communications. However, there is no guarantee that interference will not occur in a particular installation. If this equipment does cause harmful interference to radio or television reception, which can be determined by turning the equipment off and on, the user is encouraged to try to correct the interference by one or more of the following measures:

- Reorient or relocate the receiving antenna.
- Increase the separation between the equipment and receiver.
- Connect the equipment into an outlet on a circuit different from that to which the receiver is connected.
- Consult the dealer or an experienced radio/TV technician for help.

End of Report