



# RADIO TEST REPORT

**FCC ID: 2ARL5-S200**

**Product:** Projector

**Trade Name:** N/A

**Model Name:** S200

**Serial Model:** P150

**Report No.:** UNIA2018102335-2FR-01

## Prepared for

SHENZHEN AOME CO.,LTD

Room 506, Yiben building, NO.1063, Changuang road, Xili,Nanshan,Shenzhen,  
China

## Prepared by

Shenzhen United Testing Technology Co., Ltd.

2F, Annex Bldg, Jiahuangyuan Tech Park, #365 Baotian 1 Rd, Tiegang  
Community, XixiangStr, Bao'an District, Shenzhen, China

## TEST RESULT CERTIFICATION

**Applicant's name** ..... : SHENZHEN AOME CO.,LTD  
**Address** ..... : Room 506, Yiben building, NO.1063, Chaguang road,  
 Xili,Nanshan,Shenzhen, China  
**Manufacture's Name** ..... : SHENZHEN AOME CO.,LTD  
**Address** ..... : Room 506, Yiben building, NO.1063, Chaguang road,  
 Xili,Nanshan,Shenzhen, China

**Product description**

**Product name**..... : Projector  
**Trade Mark** ..... : N/A  
**Model and/or type reference** : S200, P150  
**Standards** ..... : FCC Rules and Regulations Part 15 Subpart C Section 15.247  
 ANSI C63.10: 2013  
 KDB558074 D01 V05: Guidance for Performing Compliance  
 Measurements on Digital Transmission Systems (DTS) Operating  
 Under §15.247

This device described above has been tested by Shenzhen United Testing Technology Co., Ltd., and the test results show that the equipment under test (EUT) is in compliance with the FCC requirements. And it is applicable only to the tested sample identified in the report.

This report shall not be reproduced except in full, without the written approval of UNI, this document may be altered or revised by Shenzhen United Testing Technology Co., Ltd., personnel only, and shall be noted in the revision of the document.

**Date of Test**..... : Oct. 17, 2018  
**Date (s) of performance of tests**..... : Oct. 17, 2018 - Nov. 12, 2018  
**Date of Issue**..... : Nov. 12, 2018  
**Test Result**..... : Pass

Prepared by:

*Kahn Yang*  
 Kahn yang/Editor

Reviewer:

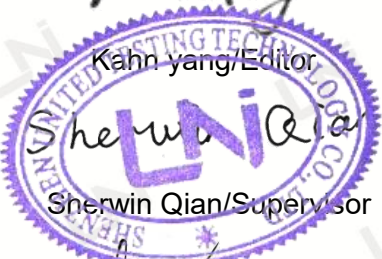

*Sherwin Qian*  
 Sherwin Qian/Supervisor

Approved & Authorized Signer:

*Liuze*  
 Liuze/Manager

## Table of Contents

<b>1</b>	<b>TEST SUMMARY .....</b>	<b>4</b>
1.1	<i>Environment conditions.....</i>	4
1.2	<i>SUMMARY of TEST RESULTS.....</i>	4
1.3	<i>TEST FACILITY.....</i>	4
1.4	<i>MEASUREMENT UNCERTAINTY.....</i>	5
<b>2</b>	<b>GENERAL INFORMATION .....</b>	<b>6</b>
2.1	<i>GENERAL DESCRIPTION OF EUT.....</i>	6
2.1	<i>CARRIER FREQUENCY OF CHANNELS.....</i>	6
2.2	<i>OPARATION OF EUT DURING TESTING.....</i>	7
2.3	<i>DESCRIPTION OF TEST SETUP.....</i>	7
2.4	<i>MEASUREMENT INSTRUMENTS LIST.....</i>	7
2.5	<i>Special Accessories .....</i>	8
<b>3</b>	<b>TEST CONDITIONS AND RESULTS .....</b>	<b>9</b>
3.1	<i>CONDUCTED EMISSIONS TEST.....</i>	9
3.2	<i>RADIATED EMISSION TEST.....</i>	12
3.3	<i>CONDUCTED OUTPUT POWER .....</i>	21
3.4	<i>POWER SPECTRAL DENSITY.....</i>	22
3.5	<i>OCCUPIED BANDWIDTH MEASUREMENT.....</i>	25
3.6	<i>OUT-OF BAND EMISSIONS.....</i>	28
3.7	<i>ANTENNA REQUIREMENT.....</i>	35
<b>4</b>	<b>PHOTOGRAPH OF TEST .....</b>	<b>36</b>
<b>5</b>	<b>PHOTOGRAPH OF EUT .....</b>	<b>37</b>

## 1 TEST SUMMARY

### 1.1 Environment conditions

During the measurement the environment condition were within the listed ranges:

Normal temperature	25°C
Relative humidity	55%
Air pressure	101KPa

### 1.2 SUMMARY of TEST RESULTS

FCC PART 15.247		
FCC Part 15.207	AC Power Conducted Emission	PASS
FCC Part 15.247(a)(2)	6dB Bandwidth	PASS
FCC Part 15.247(d)	Spurious RF Conducted Emission	PASS
FCC Part 15.247(b)	Maximum Conducted Output Power	PASS
FCC Part 15.247(e)	Power Spectral Density	PASS
FCC Part 15.109/ 15.205/ 15.209	Radiated Emissions	PASS
FCC Part 15.247(d)	Band Edge	PASS
FCC Part 15.203/15.247 (b)	Antenna Requirement	PASS

### 1.3 TEST FACILITY

Test Firm :Shenzhen United Testing Technology Co.,Ltd.

Address :2F, Annex Bldg, JiahuangyuanTech Park, #365 Baotian 1 Rd,Tiegang  
Community, Xixiang Str, Bao'an District, Shenzhen,China

The testing quality ability of our laboratory meet with "Quality Law of People's Republic of China" Clause 19.The testing quality system of our laboratory meets with ISO/IEC-17025 requirements, which is approved by CNAS. This approval result is accepted by MRA of APLAC.

Our test facility is recognized, certified, or accredited by the following organizations:

CNAS-LAB Code: L6494

The EMC Laboratory has been assessed and in compliance with CNAS-CL01 accreditation criteria for testing Laboratories (identical to ISO/IEC 17025:2017 General Requirements) for the Competence of testing Laboratories.

Designation Number: CN1227

Test Firm Registration Number: 674885

The EMC Laboratory has been registered and fully described in a report filed with the (FCC) Federal Communications commission. The acceptance letter from the FCC is maintained in our files.

## 1.4 MEASUREMENT UNCERTAINTY

Measurement Uncertainty

Conducted Emission Expanded Uncertainty = 2.23dB, k=2

Radiated emission expanded uncertainty(9kHz-30MHz) = 3.08dB, k=2

Radiated emission expanded uncertainty(30MHz-1000MHz) = 4.42dB, k=2

Radiated emission expanded uncertainty(Above 1GHz) = 4.06dB, k=2

## 2 GENERAL INFORMATION

### 2.1 GENERAL DESCRIPTION OF EUT

Equipment	Projector
Trade Mark	N/A
Model Name	S200
Serial No.	P150
Model Difference	All models have the same functionality, software and electronics, only the color, front frame shape and model names may differ. Test sample model: S200
FCC ID	2ARL5-S200
Antenna Type	FPC Antenna
Antenna Gain	0dbi
Frequency Range	802.11b/g/n20:2412~2462 MHz 802.11n40: 2422~2452MHz
Number of Channels	802.11b/g/n20: 11 802.11n40: 7
Modulation Type	CCK/DSSS, OFDM
Power supply	DC 3.7V from battery
Adapter Model	MODEL:FJ-SW1501500N INPUT:100-240~ 50/60Hz 0.6A Max OUTPUT: 15V === 1500mA

### 2.2 CARRIER FREQUENCY OF CHANNELS

#### 802.11b/g/n(20MHz)

Channel	Frequency (MHz)	Channel	Frequency (MHz)
1	2412	7	2442
2	2417	8	2447
3	2422	9	2452
4	2427	10	2457
5	2432	11	2462
6	2437		

#### 802.11n(40MHz)

Channel	Frequency (MHz)	Channel	Frequency (MHz)
3	2422	7	2442
4	2427	8	2447
5	2432	9	2452
6	2437		

## 2.3 OPERATION OF EUT DURING TESTING

Operating Mode: 802.11b/g/n(20MHz)

Low Channel:	2412MHz
Middle Channel	2437MHz
High Channel	2462MHz

Operating Mode: 802.11n(40MHz)

Low Channel:	2422MHz
Middle Channel	2437MHz
High Channel	2452MHz

## 2.4 DESCRIPTION OF TEST SETUP

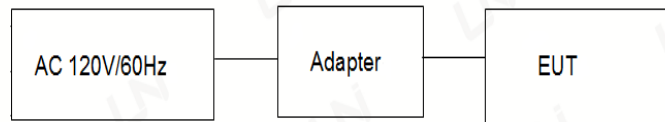

## 2.5 MEASUREMENT INSTRUMENTS LIST

Item	Equipment	Manufacturer	Model No.	Serial No.	Calibrated until
CONDUCTED EMISSIONS TEST					
1	AMN	Schwarzbeck	NNLK8121	8121370	2019.09.09
2	AMN	ETS	3810/2	00020199	2019.09.09
3	EMI TEST RECEIVER	Rohde&Schwarz	ESCI	101210	2019.09.09
4	AAN	TESEQ	T8-Cat6	38888	2019.09.09
RADIATED EMISSION TEST					
1	Horn Antenna	Sunol	DRH-118	A101415	2019.09.29
2	BicoNILog Antenna	Sunol	JB1 Antenna	A090215	2019.09.29
3	PREAMP	HP	8449B	3008A00160	2019.09.09
4	PREAMP	HP	8447D	2944A07999	2019.09.09
5	EMI TEST RECEIVER	Rohde&Schwarz	ESR3	101891	2019.09.09
6	VECTOR Signal Generator	Rohde&Schwarz	SMU200A	101521	2019.09.28
7	Signal Generator	Agilent	E4421B	MY4335105	2019.09.28
8	MXA Signal Analyzer	Agilent	N9020A	MY50510140	2019.09.28
9	MXA Signal Analyzer	Agilent	N9020A	MY51110104	2019.09.09
10	ANT Tower&Turn table Controller	Champro	EM 1000	60764	2019.09.28

11	Anechoic Chamber	Taihe Maorui	9m*6m*6m	966A0001	2019.09.09
12	Shielding Room	Taihe Maorui	6.4m*4m*3m	643A0001	2019.09.09
13	RF Power sensor	DARE	RPR3006W	15I00041SNO88	2019.03.14
14	RF Power sensor	DARE	RPR3006W	15I00041SNO89	2019.03.14
15	RF power divider	Anritsu	K241B	992289	2019.09.28
16	Wideband radio communication tester	Rohde&Schwarz	CMW500	154987	2019.09.28
17	Biconical antenna	Schwarzbeck	VHA 9103	91032360	2019.09.08
18	Biconical antenna	Schwarzbeck	VHA 9103	91032361	2019.09.08
19	Broadband Hybrid Antennas	Schwarzbeck	VULB9163	VULB9163#958	2019.09.08
20	Horn Antenna	Schwarzbeck	BBHA9120D	9120D-1680	2019.01.12
21	Active Receive Loop Antenna	Schwarzbeck	FMZB 1919B	00023	2019.11.02
22	Horn Antenna	Schwarzbeck	BBHA 9170	BBHA9170651	2019.03.14
23	Microwave Broadband Preamplifier	Schwarzbeck	BBV 9721	100472	2019.10.24
24	Active Loop Antenna	Com-Power	AL-130R	10160009	2019.05.10
25	Power Meter	KEYSIGHT	N1911A	MY50520168	2019.05.10

Note: The calibration interval was one year

## 2.6 Special Accessories

Manufacturer	Description	Model	Serial Number	Certificate
---	---	---	---	---
---	---	---	---	---



### 3 TEST CONDITIONS AND RESULTS

#### 3.1 CONDUCTED EMISSIONS TEST

##### Limit

According to FCC CFR Title 47 Part 15 Subpart C Section 15.207 and RSS Gen 8.8, AC Power Line Conducted Emissions Limits for Licence-Exempt Radio Apparatus as below:

Frequency range (MHz)	Limit (dBuV)	
	Quasi-peak	Average
0.15-0.5	66 to 56*	56 to 46*
0.5-5	56	46
5-30	60	50

\* Decreasing linearly with the logarithm of the frequency

For intentional device, according to §15.207(a) Line Conducted Emission Limit is same as above table.

##### Test Setup

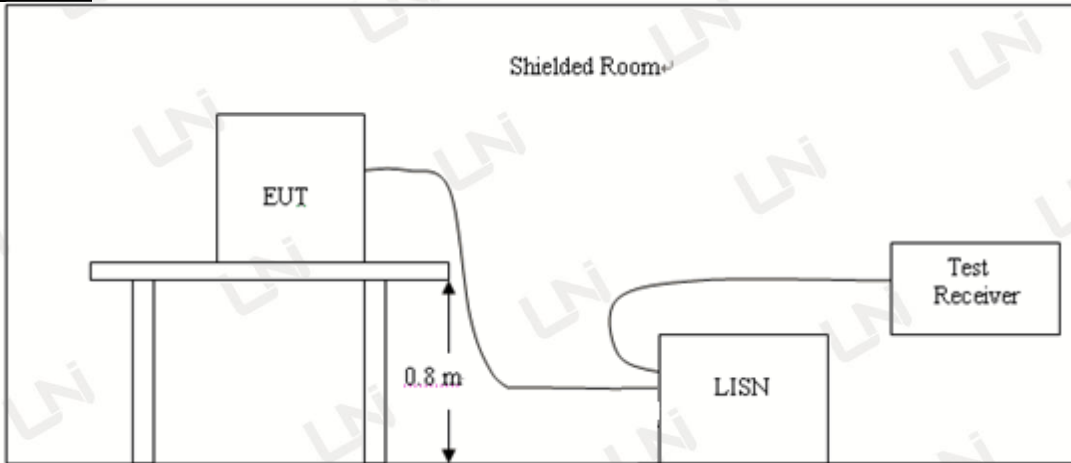

##### Test Procedure

- 1, The equipment was set up as per the test configuration to simulate typical actual usage per the user's manual. A wooden table with a height of 0.8 meters is used and is placed on the ground plane as per ANSI C63.10.
- 2, Support equipment, if needed, was placed as per ANSI C63.10.
- 3, All I/O cables were positioned to simulate typical actual usage as per ANSI C63.10.
- 4, If a EUT received DC power from the USB Port of Notebook PC, the PC's adapter received AC power through a Line Impedance Stabilization Network (LISN) which supplied power source and was grounded to the ground plane.
- 5, All support equipments received AC power from a second LISN, if any.
- 6, The EUT test program was started. Emissions were measured on each current carrying line of the EUT using a spectrum Analyzer / Receiver connected to the LISN powering the EUT. The LISN has two monitoring points: Line 1 (Hot Side) and Line 2 (Neutral Side). Two scans were taken: one with Line 1 connected to Analyzer / Receiver and Line 2 connected to a 50 ohm load; the second scan had Line 1 connected to a 50 ohm load and Line 2 connected to the Analyzer / Receiver.
- 7, Analyzer / Receiver scanned from 150 KHz to 30MHz for emissions in each of the test modes.

**Test Result**

**---PASS---**

Remark:

1. All modes of 802.11b/g/n were tested at Low, Middle, and High channel; only the worst result of 802.11b CH11 was reported as below:
2. Both 120 VAC, 50/60 Hz and 240 VAC, 50/60 Hz power supply have been tested, only the worst result of 120 VAC, 60 Hz was reported as below:

Temperature:	25°C	Relative Humidity:	48%
Test Date:	Nov. 05, 2018	Pressure:	1030hPa
Test Voltage:	AC 120V 60Hz	Polarization:	

Please refer to test data as follows:

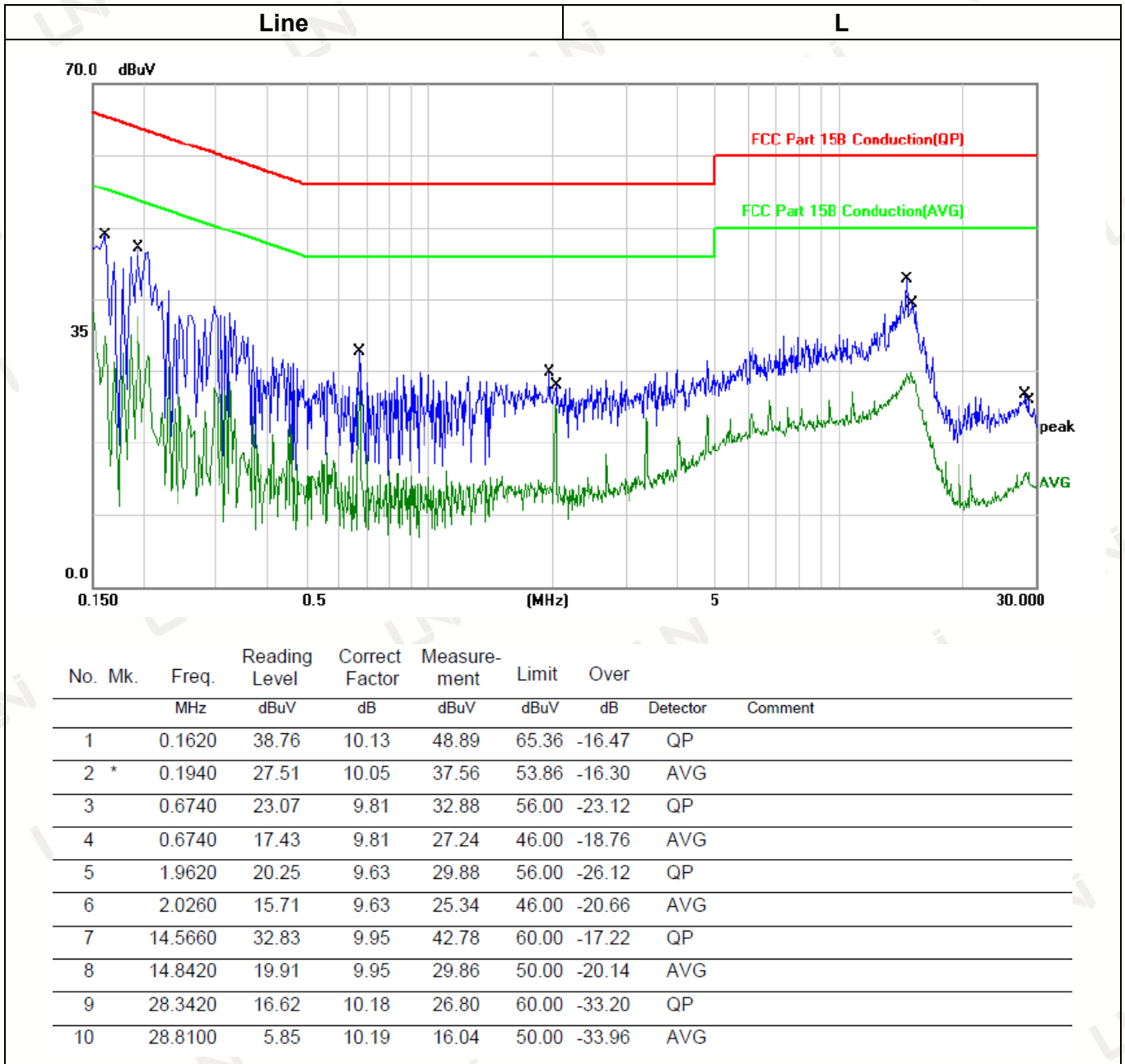

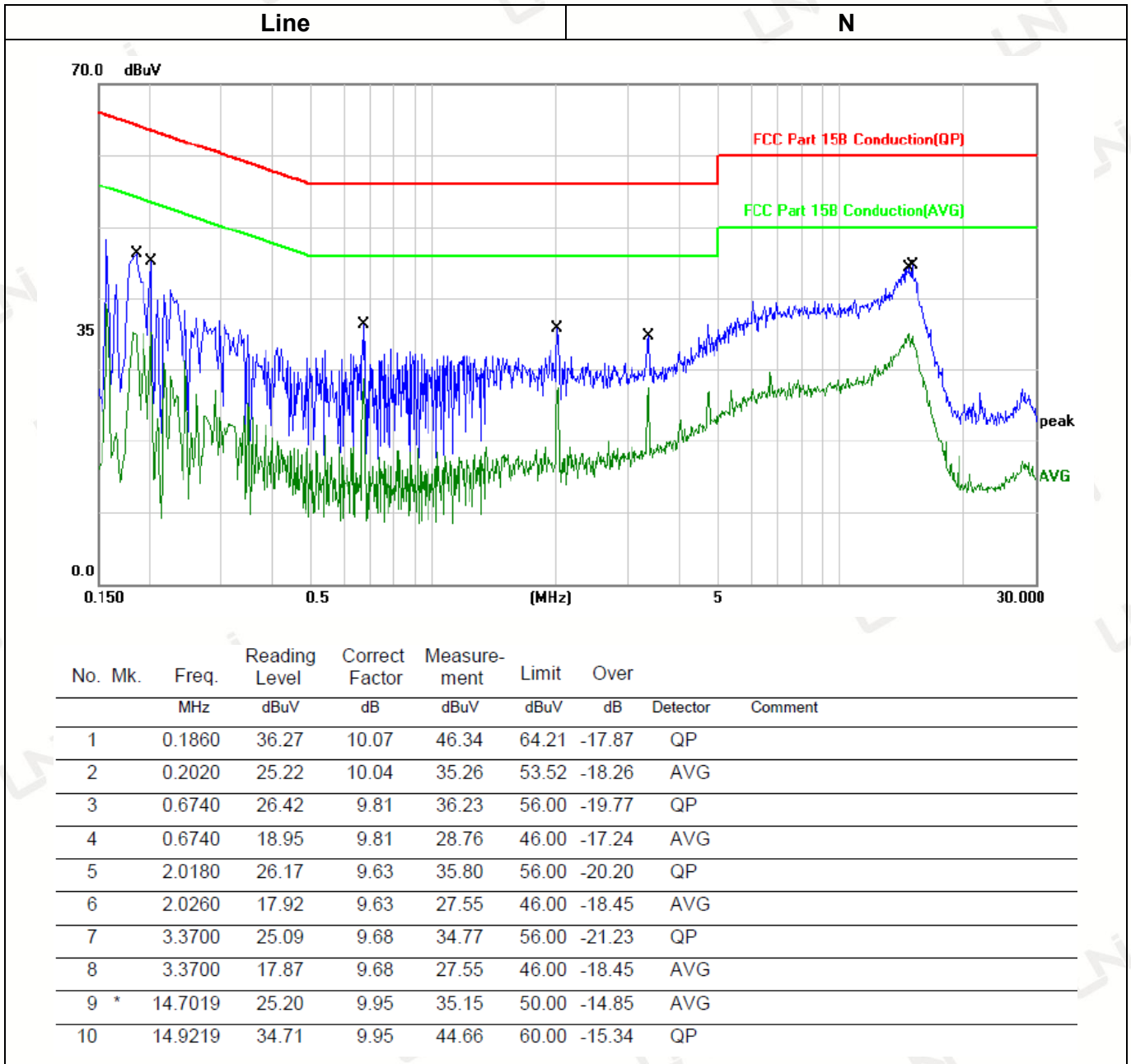

### 3.2 RADIATED EMISSION TEST

#### Limit

For intentional device, according to § 15.209(a), the general requirement of field strength of radiated emission out of authorized band shall not exceed the following table at a 3 meters measurement distance.

In addition, radiated emissions which fall in the restricted bands, as defined in §15.205(a), must also comply with the radiated emission limits specified in §15.209(a)

Except when the requirements applicable to a given device state otherwise, emissions from licence-exempt transmitters shall comply with the field strength limits shown in table below. Additionally, the level of any transmitter emission shall not exceed the level of the transmitter’s fundamental emission

Unwanted emissions that fall into restricted bands shall comply with the limits specified in RSS-Gen; and Unwanted emissions that do not fall within the restricted frequency bands shall comply either with the limits specified in the applicable RSS or with those specified in this RSS-Gen.

Radiated emission limits

Frequency (MHz)	Distance (Meters)	Radiated (dBµV/m)	Radiated (µV/m)
0.009-0.49	3	$20\log(2400/F(KHz))+40\log(300/3)$	$2400/F(KHz)$
0.49-1.705	3	$20\log(24000/F(KHz))+40\log(30/3)$	$24000/F(KHz)$
1.705-30	3	$20\log(30)+40\log(30/3)$	30
30-88	3	40.0	100
88-216	3	43.5	150
216-960	3	46.0	200
Above 960	3	54.0	500

#### Test Setup

##### 1. Radiated Emission Test-Up Frequency Below 30MHz

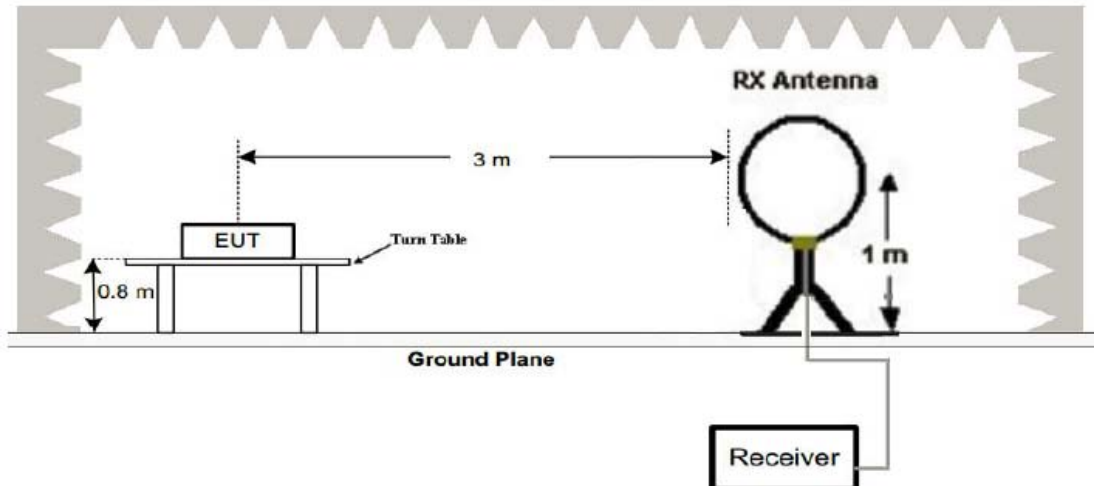

2. Radiated Emission Test-Up Frequency 30MHz~1GHz

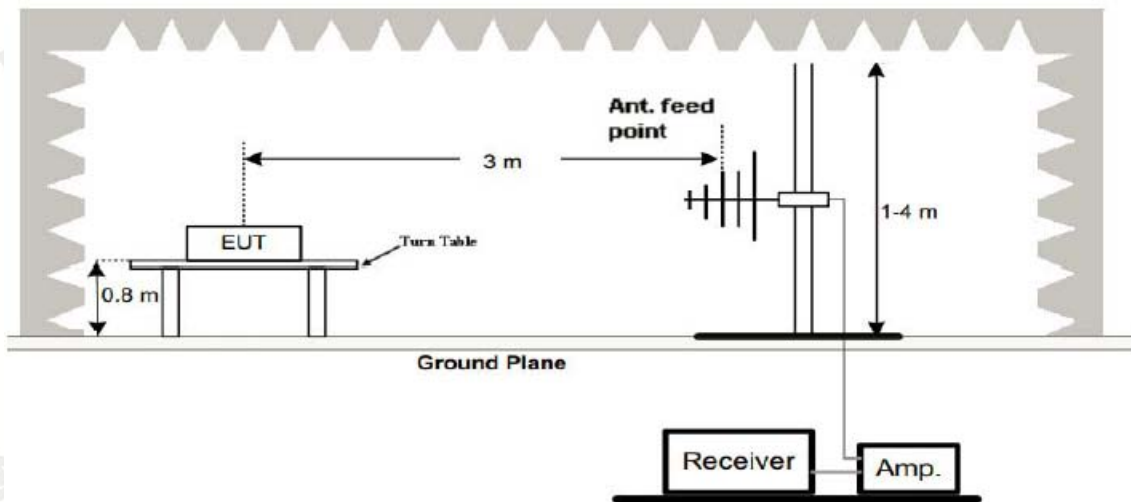

3. Radiated Emission Test-Up Frequency Above 1GHz

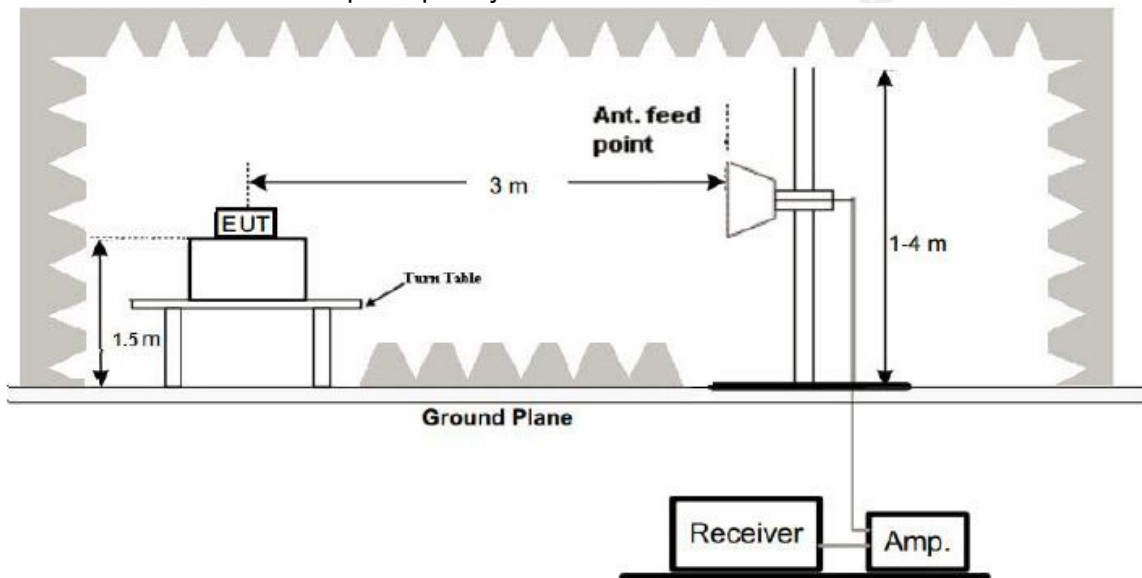

**Test Procedure**

1. Below 1GHz measurement the EUT is placed on a turntable which is 0.8m above ground plane, and above 1GHz measurement EUT was placed on a low permittivity and low loss tangent turn table which is 1.5m above ground plane.
2. Maximum procedure was performed by raising the receiving antenna from 1m to 4m and rotating the turn table from 0° to 360° to acquire the highest emissions from EUT
3. And also, each emission was to be maximized by changing the polarization of receiving antenna both horizontal and vertical.
4. Repeat above procedures until all frequency measurements have been completed.
5. Radiated emission test frequency band from 9KHz to 25GHz.
6. The distance between test antenna and EUT as following table states:

Test Frequency range	Test Antenna Type	Test Distance
9KHz-30MHz	Active Loop Antenna	3
30MHz-1GHz	Bilog Antenna	3
1GHz-18GHz	Horn Antenna	3
18GHz-25GHz	Horn Antenna	1

7. Setting test receiver/spectrum as following table states:

Test Frequency range	Test Receiver/Spectrum Setting	Detector
9KHz-150KHz	RBW=200Hz/VBW=3KHz,Sweep time=Auto	QP
150KHz-30MHz	RBW=9KHz/VBW=100KHz,Sweep time=Auto	QP
30MHz-1GHz	RBW=120KHz/VBW=1000KHz,Sweep time=Auto	QP
1GHz-40GHz	Peak Value: RBW=1MHz/VBW=3MHz, Sweep time=Auto Average Value: RBW=1MHz/VBW=10Hz, Sweep time=Auto	Peak

**TEST RESULTS**

**---PASS---**

Remark:

1. This test was performed with EUT in X, Y, Z position and the worse case was found when EUT in Z position.
2. All three channels (lowest/middle/highest) of each mode were measured below 1GHz and recorded worst case at 802.11b low channel.
3. All three channels (lowest/middle/highest) of each mode were measured above1GHz and recorded worst case at 802.11b mode.
4. Radiated emission test from 9 KHz to 10th harmonic of fundamental was verified, and no emission found except system noise floor in 9 KHz to 30MHz and not recorded in this report.

**Below 1GHz Test Results:**

Temperature:	25°C	Relative Humidity:	48%
Test Date:	Nov. 05, 2018	Pressure:	1030hPa
Test Voltage:	AC 120V 60Hz	Polarization:	Horizontal and Vertical

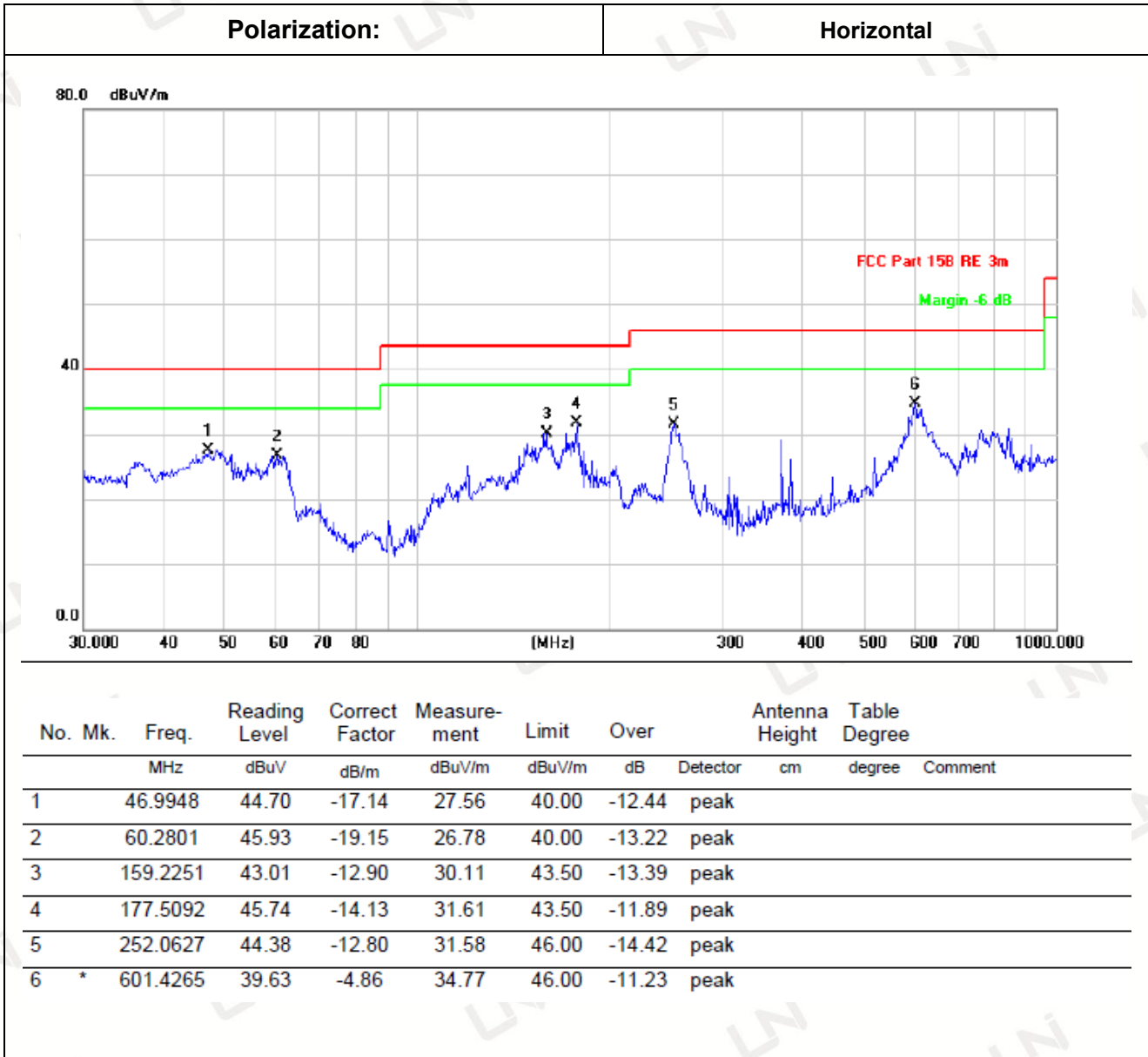

Remark: Absolute Level= Reading Level+ Factor, Margin= Absolute Level – Limit  
 Factor=Ant. Factor + Cable Loss – Pre-amplifier

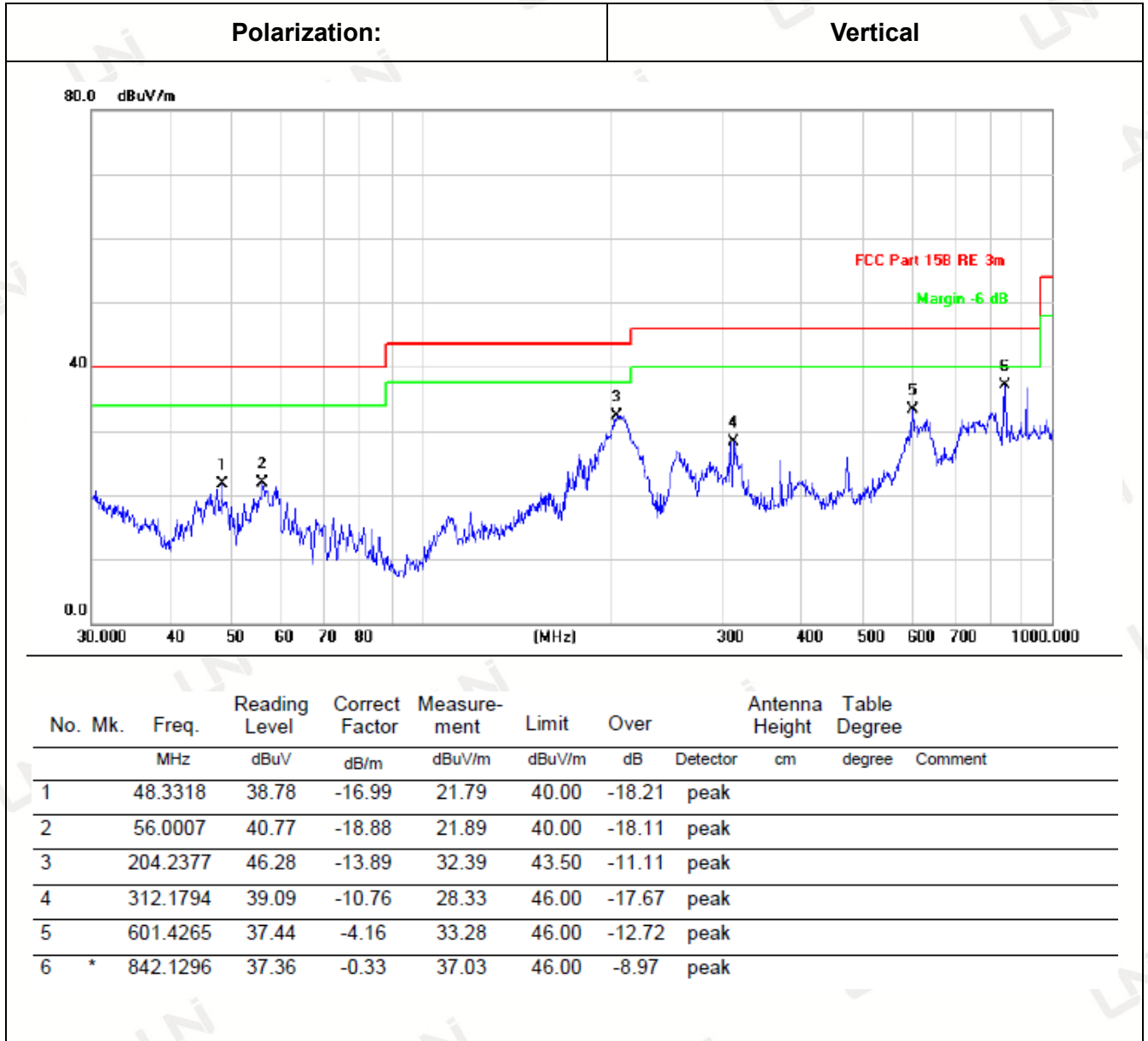

Remark: Absolute Level= Reading Level+ Factor, Margin= Absolute Level – Limit  
 Factor=Ant. Factor + Cable Loss – Pre-amplifier

**Remark:**

- (1) Measuring frequencies from 9 kHz to the 1 GHz, Radiated emission test from 9kHz to 30MHz was verified, and no any emission was found except system noise floor.
- (2) \* denotes emission frequency which appearing within the Restricted Bands specified in provision of 15.205, then the general radiated emission limits in 15.209 apply.
- (3) The IF bandwidth of EMI Test Receiver between 30MHz to 1GHz was 120KHz, 1 MHz for measuring above 1 GHz, below 30MHz was 10KHz.



**Above 1 GHz Test Results:**

Note: 802.11b/802.11g/802.11n(H20)/802.11n(H40) all have been tested, only worse case 802.11b is reported.

**802.11b Mode (2412MHz)**

**Horizontal:**

Frequency (MHz)	Reading Result (dBμV)	Factor (dB)	Emission Level (dBμV/m)	Limits (dBμV/m)	Margin (dB)	Detector Type
4824.00	54.11	-3.64	50.47	74	23.53	PK
4824.00	45.00	-3.64	41.36	54	12.64	AV
7236.00	49.72	-0.95	48.77	74	25.23	PK
7236.00	40.57	-0.95	39.62	54	14.38	AV
--	--	--	--	--	--	--

**Vertical:**

Frequency (MHz)	Reading Result (dBμV)	Factor (dB)	Emission Level (dBμV/m)	Limits (dBμV/m)	Margin (dB)	Detector Type
4824.00	55.18	-3.64	51.54	74	22.46	PK
4824.00	46.27	-3.64	42.63	54	11.37	AV
7236.00	50.53	-0.95	49.58	74	24.42	PK
7236.00	41.18	-0.95	40.23	54	13.77	AV
--	--	--	--	--	--	--

**802.11b Mode (2437MHz)**

**Horizontal:**

Frequency (MHz)	Reading Result (dBμV)	Factor (dB)	Emission Level (dBμV/m)	Limits (dBμV/m)	Margin (dB)	Detector Type
4874.00	54.07	-3.51	50.56	74	23.44	PK
4874.00	44.99	-3.51	41.48	54	12.52	AV
7311.00	48.34	-0.82	47.52	74	26.48	PK
7311.00	39.43	-0.82	38.61	54	15.39	AV
--	--	--	--	--	--	--

**Vertical:**

Frequency	Reading Result	Factor	Emission Level	Limits	Margin	Detector
(MHz)	(dBμV)	(dB)	(dBμV/m)	(dBμV/m)	(dB)	Type
4874.00	54.77	-3.51	51.26	74	22.74	PK
4874.00	46.05	-3.51	42.54	54	11.46	AV
7311.00	51.05	-0.82	50.23	74	23.77	PK
7311.00	42.29	-0.82	41.47	54	12.53	AV
--	--	--	--	--	--	--

**802.11b Mode (2462MHz)**

**Horizontal:**

Frequency	Reading Result	Factor	Emission Level	Limits	Margin	Detector
(MHz)	(dBμV)	(dB)	(dBμV/m)	(dBμV/m)	(dB)	Type
4924	54.69	-3.43	51.26	74	22.74	PK
4924	46.42	-3.43	42.99	54	11.01	AV
7386	51.20	-0.75	50.45	74	23.55	PK
7386	41.95	-0.75	41.2	54	12.80	AV
--	--	--	--	--	--	--

**Vertical:**

Frequency	Reading Result	Factor	Emission Level	Limits	Margin	Detector
(MHz)	(dBμV)	(dB)	(dBμV/m)	(dBμV/m)	(dB)	Type
4924	55.32	-3.43	51.89	74	22.11	PK
4924	47.06	-3.43	43.63	54	10.37	AV
7386	50.49	-0.75	49.74	74	24.26	PK
7386	41.27	-0.75	40.52	54	13.48	AV
--	--	--	--	--	--	--

**Remark:**

- (1) Measuring frequencies from 1 GHz to the 25 GHz.
- (2) Factor = Antenna Factor + Cable Loss – Pre-amplifier.
- (3) Margin= Limits –Emission Level
- (4) Data of measurement within this frequency range shown “---” in the table above means the reading of emissions are attenuated more than 20dB below the permissible limits or the field strength is too small to be measured.
- (5) When the test results of Peak Detected below the limits of Average Detected, the Average Detected is not need completed. For example: Top Channel at Fundamental 73.16dBuV/m(PK Value) <93.98(AV Limit), at harmonic 53.20 dBuV/m(PK Value) <54 dBuV/m(AV Limit), the Average Detected not need to completed.
- (6) All modes of operation were investigated and the worst-case emissions are reported.

**Radiated Band Edge Test:**

Note: 802.11b/802.11g/802.11n (H20)/802.11n (H40) all have been tested, only worse case 802.11bis reported

**802.11b Mode (2412MHz)**

**Horizontal:**

Frequency (MHz)	Reading Result (dBµV)	Factor (dB)	Emission Level (dBµV/m)	Limits (dBµV/m)	Margin (dB)	Detector Type
2379.50	53.50	-5.81	47.69	74	26.31	PK
2379.50	--	--	--	54	--	AV
2390.00	52.36	-5.84	46.52	74	27.48	PK
2390.00	--	--	--	54	--	AV
2400.00	56.05	-5.84	50.21	74	23.79	PK
2400.00	--	--	--	54	--	AV

**Vertical:**

Frequency (MHz)	Reading Result (dBµV)	Factor (dB)	Emission Level (dBµV/m)	Limits (dBµV/m)	Margin (dB)	Detector Type
2379.50	54.77	-5.81	48.96	74	25.04	PK
2379.50	--	--	--	54	--	AV
2390.00	53.09	-5.84	47.25	74	26.75	PK
2390.00	--	--	--	54	--	AV
2400.00	57.08	-5.84	51.24	74	22.76	PK
2400.00	--	--	--	54	--	AV

**802.11b Mode (2462MHz)**

**Horizontal (Worst case):**

Frequency (MHz)	Reading Result (dBµV)	Factor (dB)	Emission Level (dBµV/m)	Limits (dBµV/m)	Margin (dB)	Detector Type
2483.50	54.97	-5.65	49.32	74	24.68	PK
2483.50	--	--	--	54	--	AV
2484.75	56.19	-5.65	50.54	74	23.46	PK
2484.75	--	--	--	54	--	AV
2500.00	50.93	-5.72	45.21	74	28.79	PK
2500.00	--	--	--	54	--	AV

**Vertical:**

Frequency (MHz)	Reading Result (dBμV)	Factor (dB)	Emission Level (dBμV/m)	Limits (dBμV/m)	Margin (dB)	Detector Type
2483.50	56.63	-5.65	50.98	74	23.02	PK
2483.50	--	--	--	54	--	AV
2484.75	57.22	-5.65	51.57	74	22.43	PK
2484.75	--	--	--	54	--	AV
2500.00	51.97	-5.72	46.25	74	27.75	PK
2500.00	--	--	--	54	--	AV

**Remark:**

- (1) Factor = Antenna Factor + Cable Loss – Pre-amplifier.
- (2) Margin = Limits – Emission Level
- (3) -- Mean the PK detector measured value is below average limit.

### 3.3 CONDUCTED OUTPUT POWER

**Limit**

The Maximum Peak Output Power Measurement is 30dBm.

**Test Procedure**

Remove the antenna from the EUT and then connect a low loss RF cable from the antenna port to the power sensor.

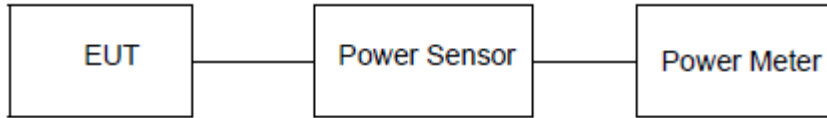

**Test Result**

---PASS---

Type	Channel	PK Output power (dBm)	AV Output power (dBm)	Limit (dBm)	Result
802.11b	01	9.72	5.74	30.00	Pass
	06	9.34	5.52		
	11	9.20	5.49		
802.11g	01	9.04	4.37		
	06	8.87	4.25		
	11	8.81	4.22		
802.11n(HT20)	01	8.47	4.15		
	06	8.58	4.19		
	11	8.41	4.16		
802.11n(HT40)	03	6.34	3.89		
	06	6.26	3.77		
	09	6.07	3.53		

Note: 1.The test results including the cable lose.

### 3.4 POWER SPECTRAL DENSITY

#### Limit

For digitally modulated systems, the power spectral density conducted from the intentional radiator to the antenna shall not be greater than 8dBm in any 3 kHz band during any time interval of continuous transmission.

#### Test Procedure

1. Use this procedure when the maximum peak conducted output power in the fundamental emission is used to demonstrate compliance.
2. Set the RBW  $\geq$  3 kHz.
3. Set the VBW  $\geq$  3 $\times$  RBW.
4. Set the span to 1.5 times the DTS channel bandwidth.
5. Detector = peak.
6. Sweep time = auto couple.
7. Trace mode = max hold.
8. Allow trace to fully stabilize.
9. Use the peak marker function to determine the maximum power level.
10. If measured value exceeds limit, reduce RBW (no less than 3 kHz) and repeat.
11. The resulting peak PSD level must be 8dBm.

#### Test Configuration

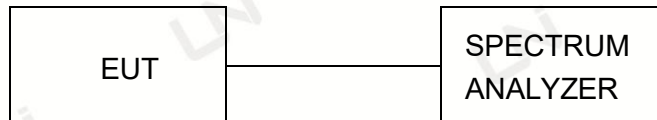

#### Test Results

Type	Channel	Power Spectral Density (dBm/3KHz)	Limit (dBm/3KHz)	Result
802.11b	01	-14.184	8.00	Pass
	06	-14.016		
	11	-13.215		
802.11g	01	-15.875		
	06	-15.355		
	11	-16.857		
802.11n(HT20)	01	-17.545		
	06	-16.383		
	11	-16.561		
802.11n(HT40)	03	-21.233		
	06	-22.231		
	09	-21.659		

Test plot as follows:

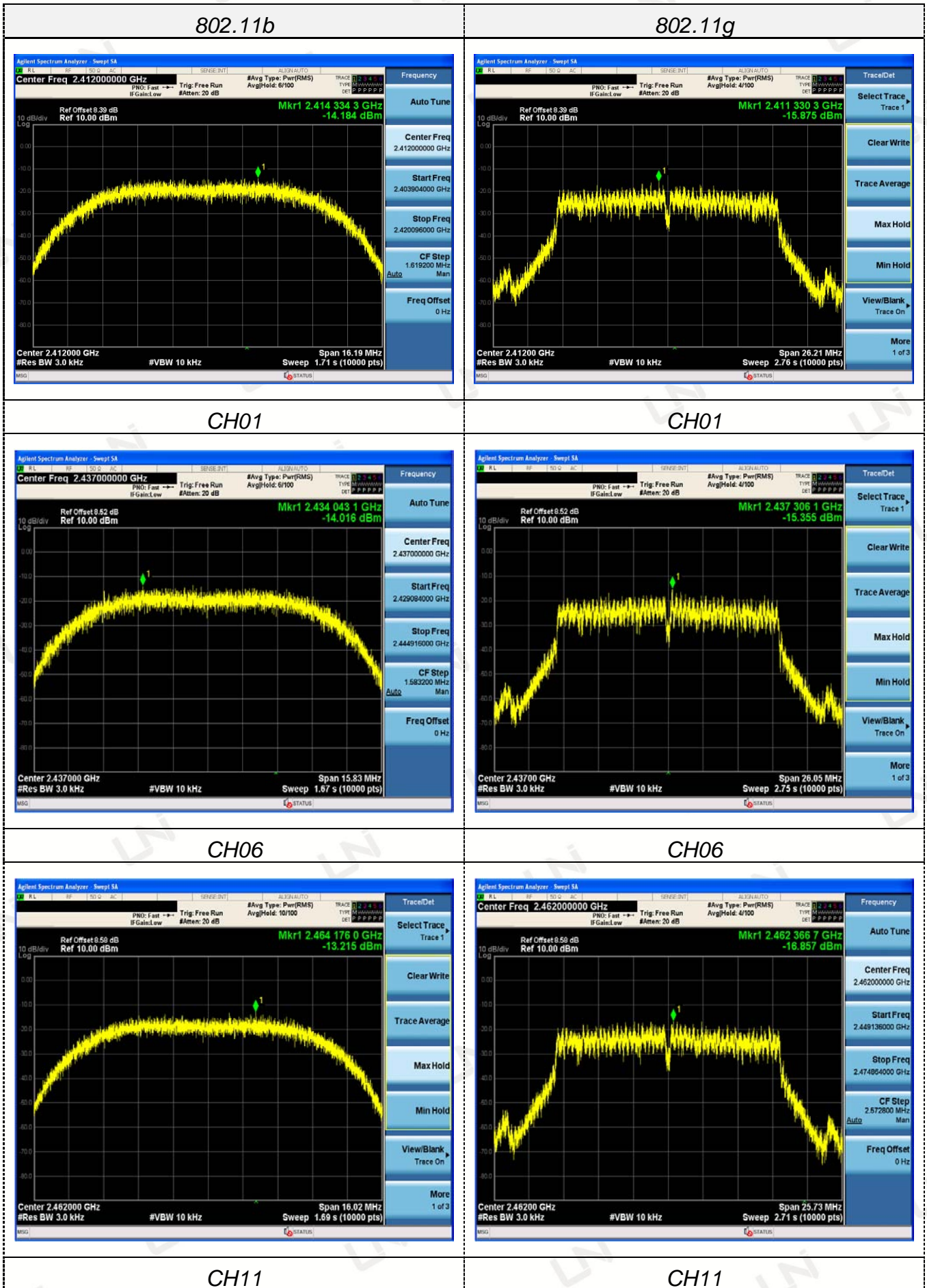

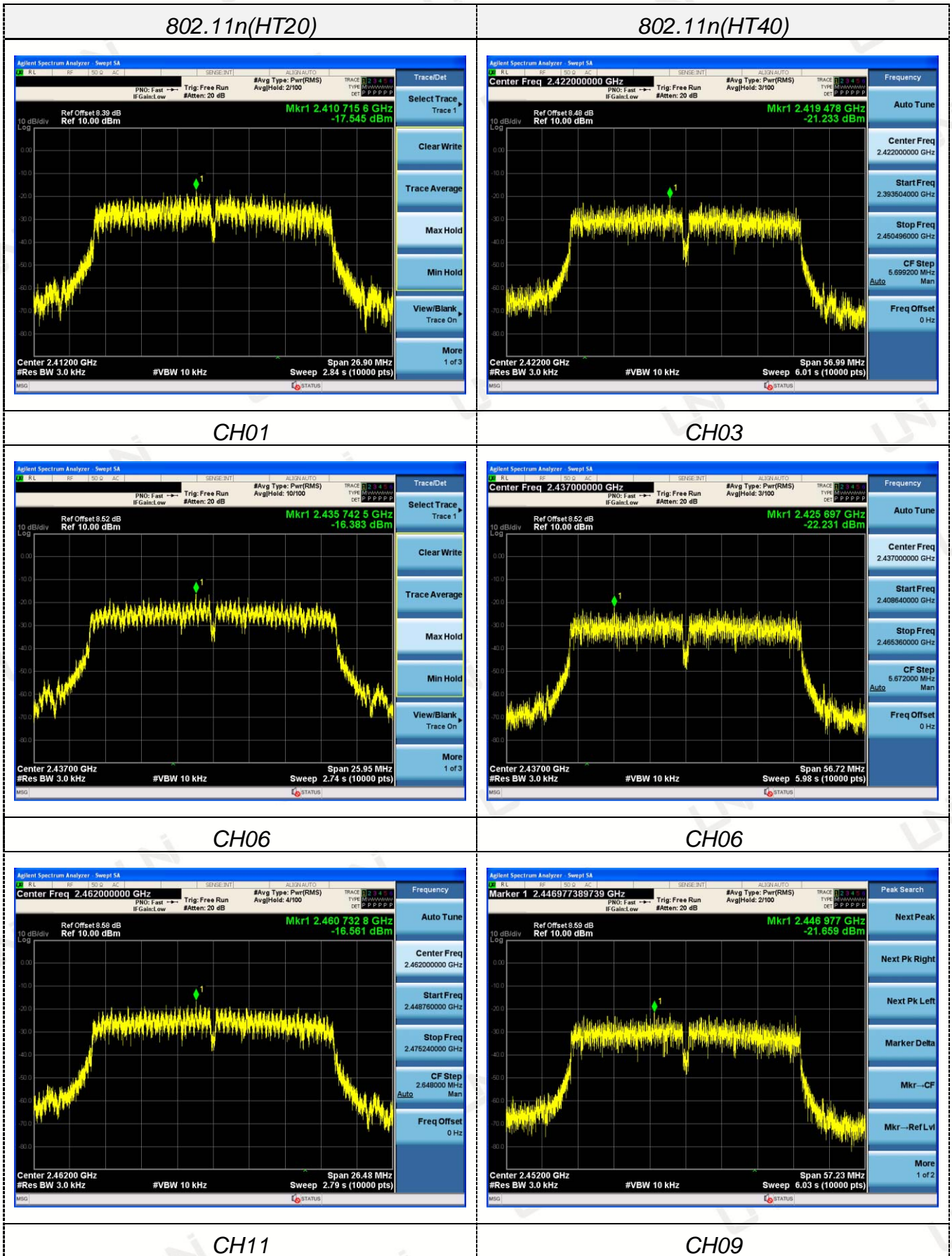



### 3.5 OCCUPIED BANDWIDTH MEASUREMENT

#### Test Limit

FCC Part15(15.247), Subpart C				
Section	Test Item	Limit	Frequency Range (MHz)	Result
15.247(a)(2)	Bandwidth	>= 500KHz (6dB bandwidth)	2400-2483.5	PASS

#### Test Procedure

1. The EUT was placed on a turn table which is 0.8m above ground plane.
2. Set EUT as normal operation.
3. Based on ANSI C63.10 section 6.9.2: RBW=30KHz, VBW=100KHz, Span=3MHz.
4. The useful radiated emission from the EUT was detected by the spectrum analyzer with peak detector.

#### Measurement Equipment Used

Same as Radiated Emission Measurement

#### Test Result

---PASS---

Type	Channel	6dB Bandwidth (MHz)	99% OBW (MHz)	Limit (KHz)	Result
802.11b	01	10.12	12.039	≥500	Pass
	06	9.895	12.056		
	11	10.01	11.987		
802.11g	01	16.38	16.351		
	06	16.28	16.339		
	11	16.08	16.351		
802.11n(HT20)	01	16.81	17.454		
	06	16.22	17.463		
	11	16.55	17.468		
802.11n(HT40)	03	35.62	35.919		
	06	35.45	35.848		
	09	35.77	35.894		

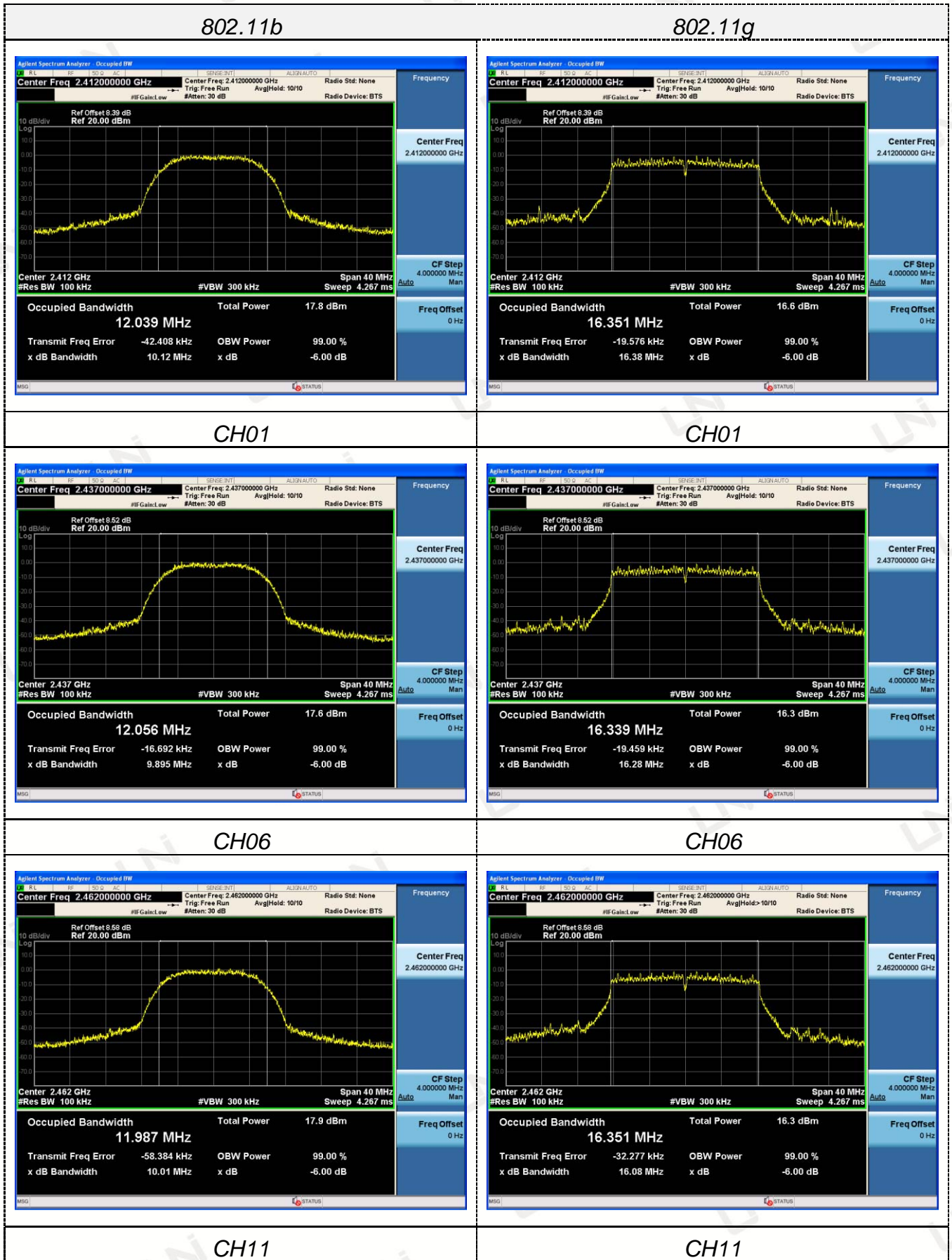

### 802.11n(HT20)

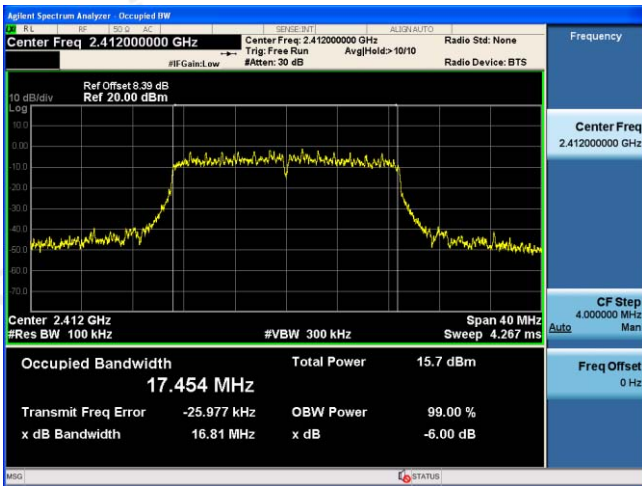

### 802.11n(HT40)

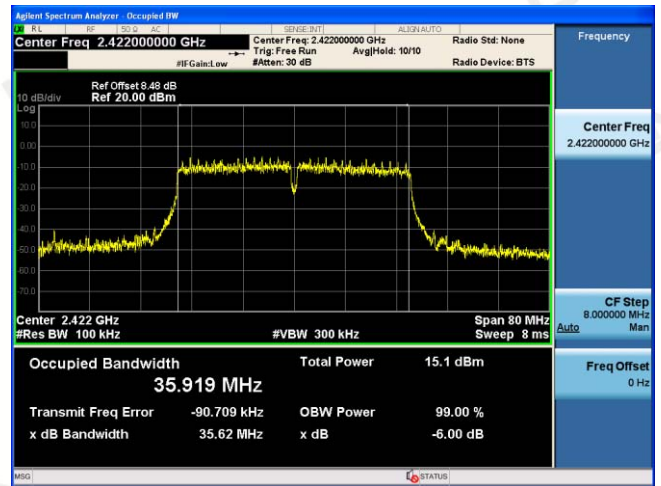

### CH01

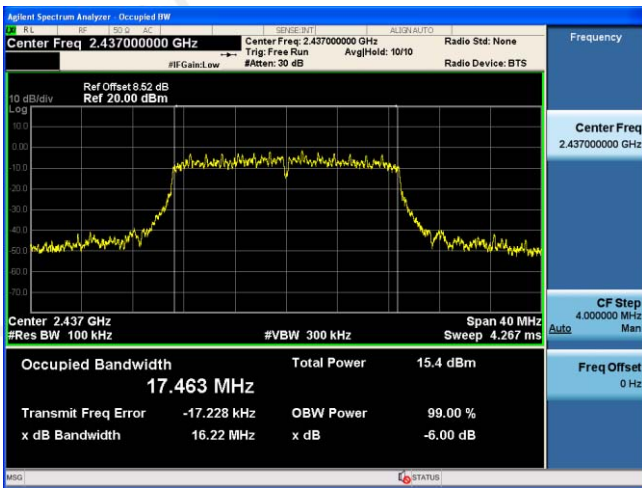

### CH03

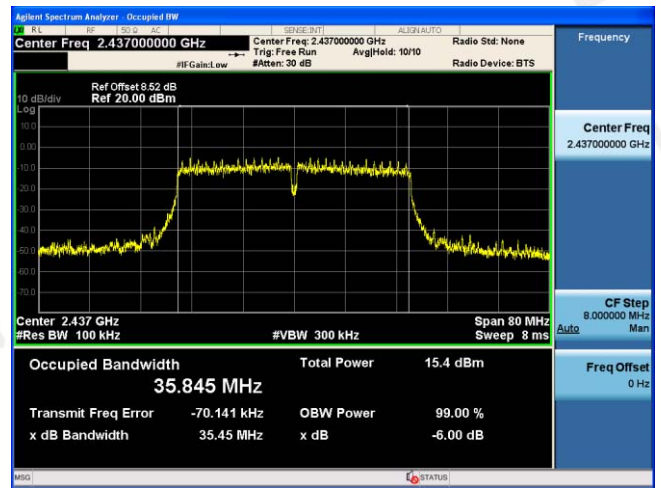

### CH06

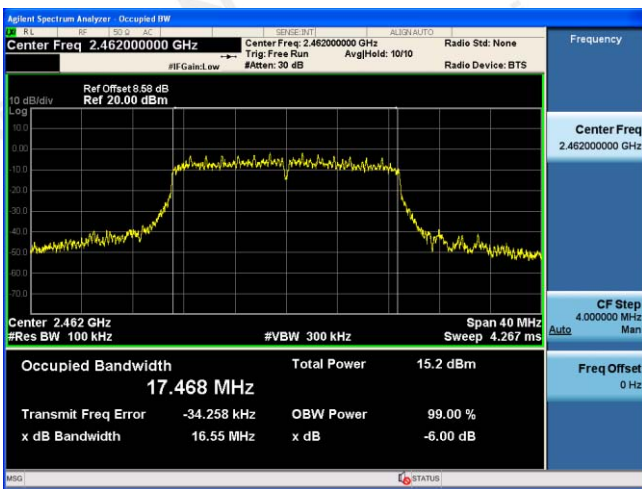

### CH06

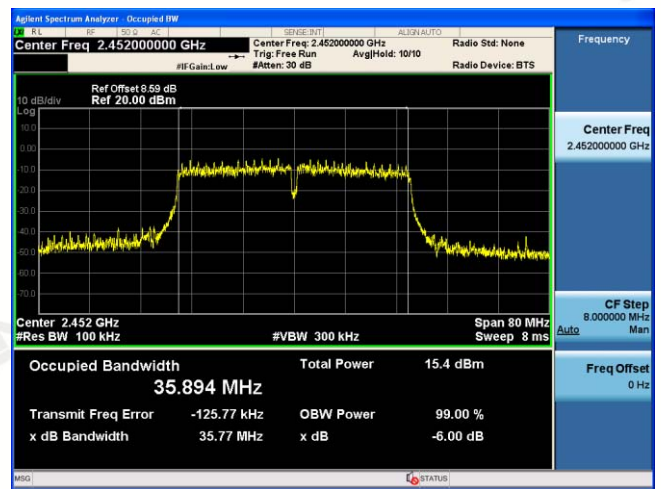

### CH11



### CH09



### 3.6 OUT-OF BAND EMISSIONS

#### Limit

In any 100 kHz bandwidth outside the frequency band in which the spread spectrum or digitally modulated intentional radiator is operating, the radio frequency power that is produced by the intentional radiator shall be at least 20 dB below that in the 100 kHz bandwidth within the band that contains the highest level of the desired power, based on either an RF conducted or a radiated measurement, provided the transmitter demonstrates compliance with the peak conducted power limits. If the transmitter complies with the conducted power limits based on the use of RMS averaging over a time interval, as permitted under paragraph (b)(3) of this section, the attenuation required under this paragraph shall be 30 dB instead of 20 dB. Attenuation below the general limits specified in §15.209(a) is not required.

#### Test Procedure

Connect the transmitter output to spectrum analyzer using a low loss RF cable, and set the spectrum analyzer to RBW=100 kHz, VBW= 300 kHz, peak detector, and max hold. Measurements utilizing these settings are made of the in-band reference level, band edge and out-of-band emissions.

#### Test Configuration

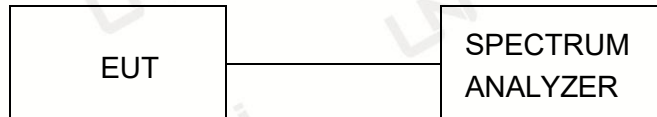

#### Test Results

Remark: The measurement frequency range is from 30MHz to the 10th harmonic of the fundamental frequency. The lowest, middle and highest channels are tested to verify the spurious emissions and band edge measurement data.

### 802.11b

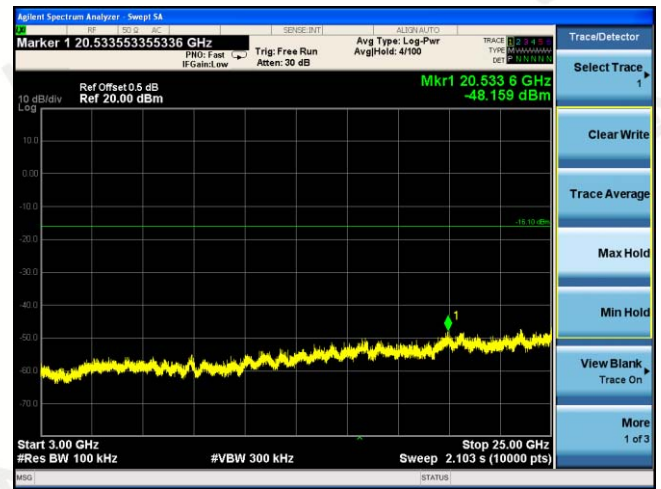
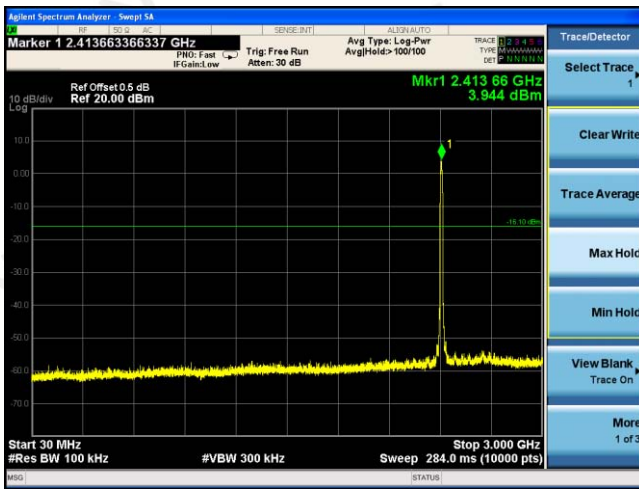

### CH01

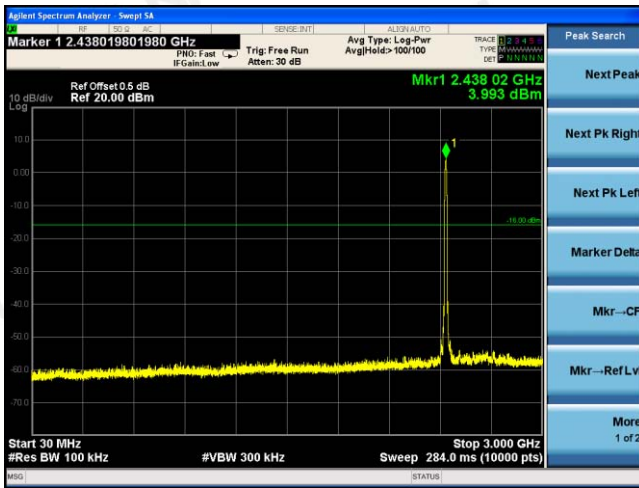

### CH06

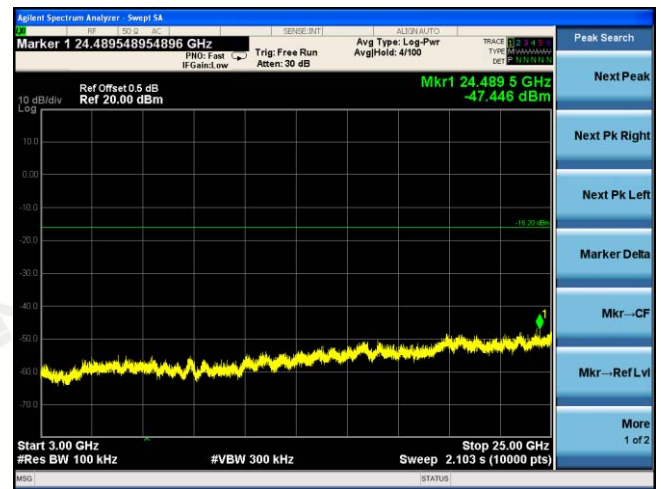
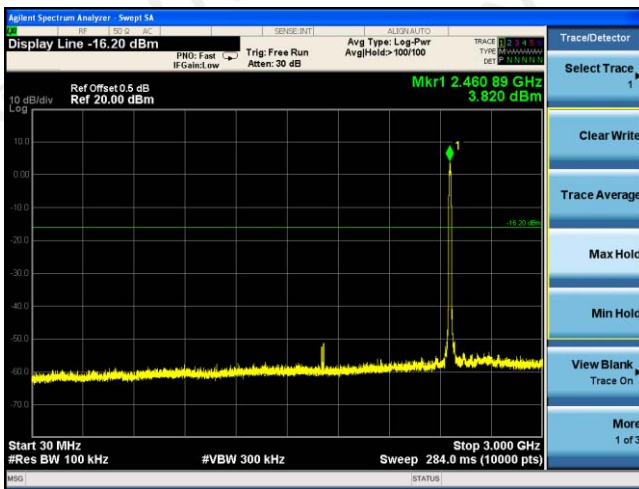

### CH11

### 802.11g

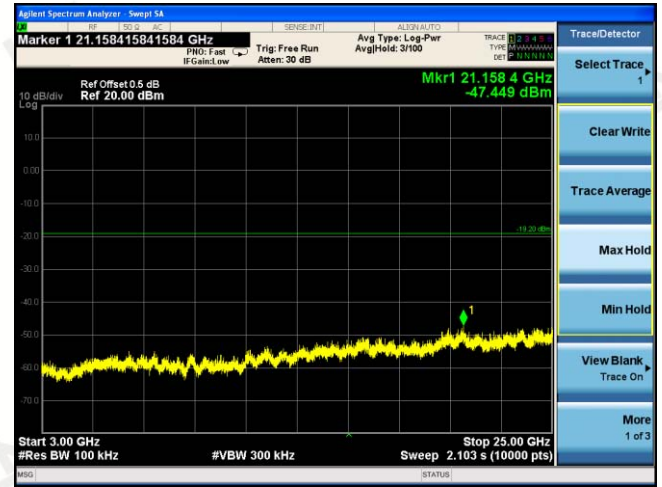
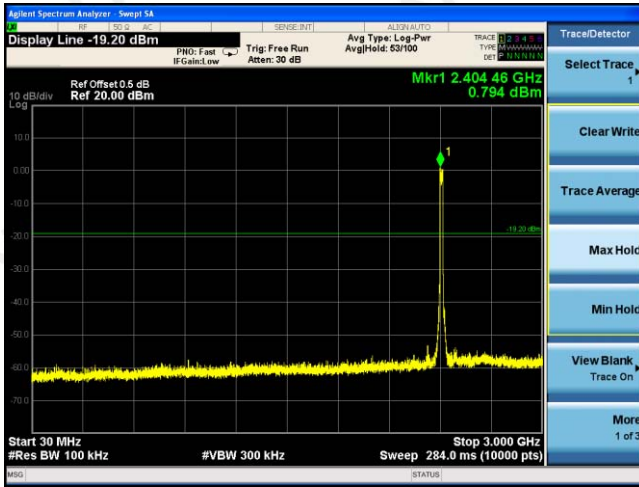

### CH01

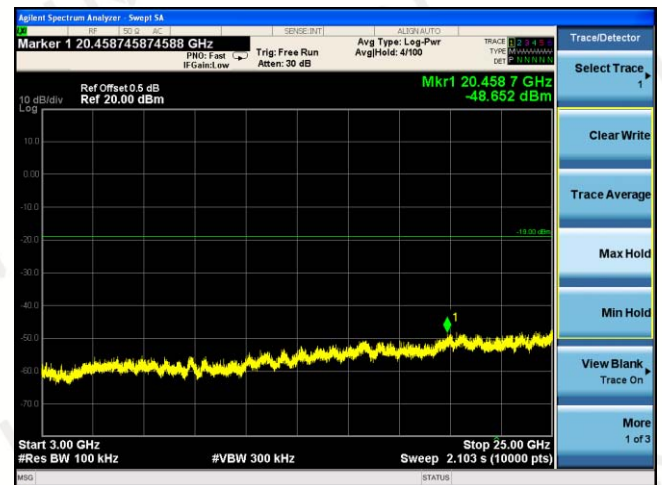
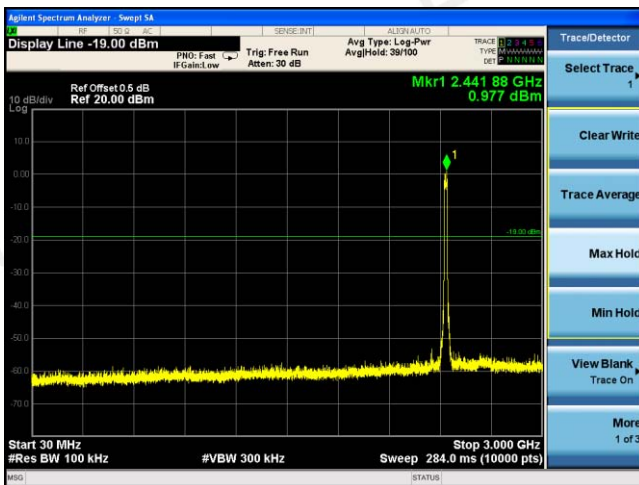

### CH06

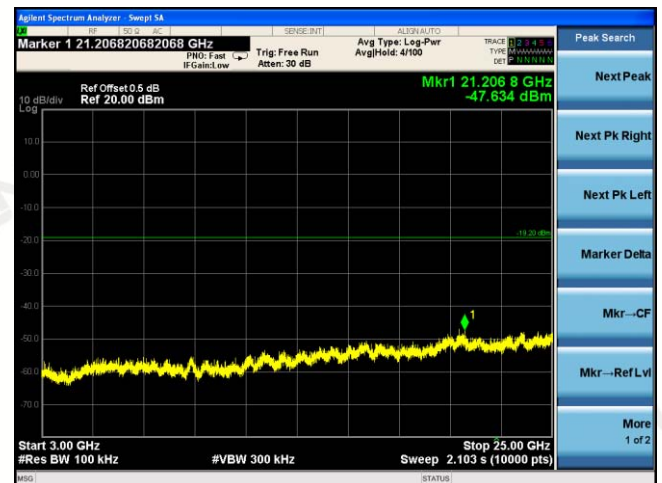
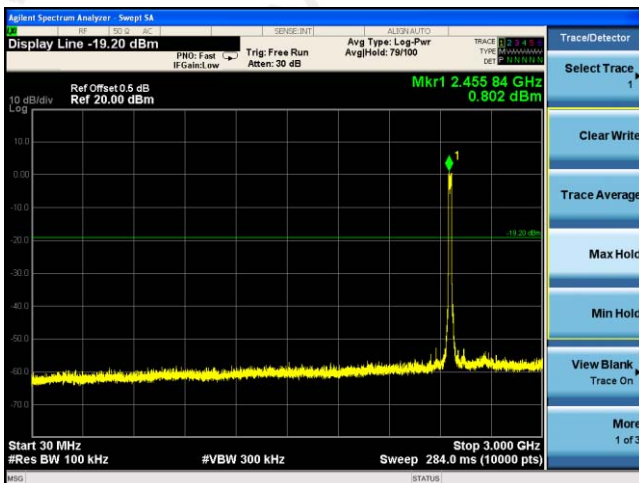

### CH11

### 802.11n(HT20)

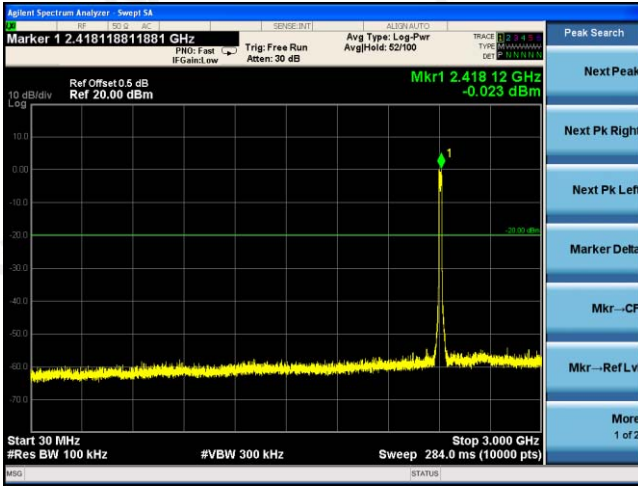

### CH01

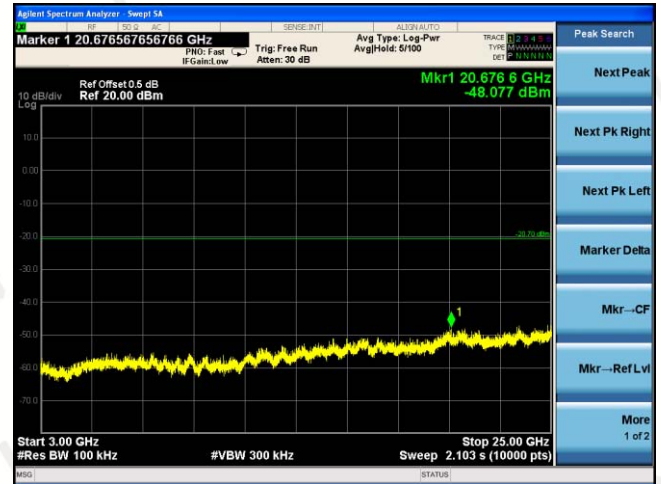
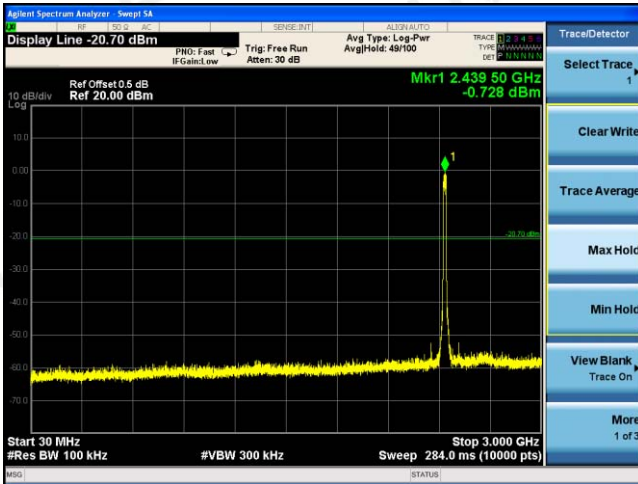

### CH06

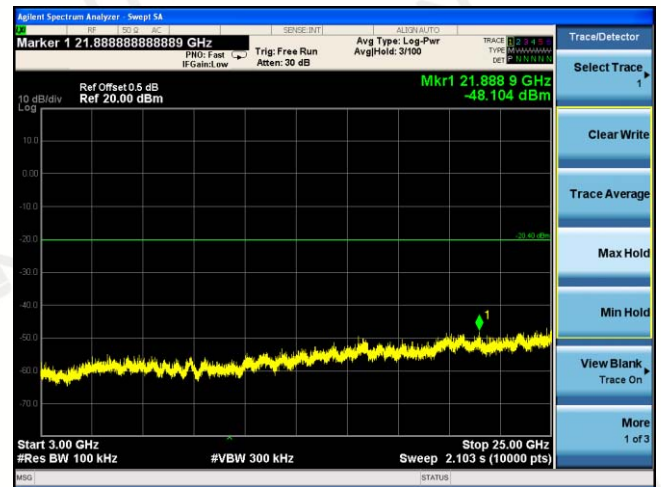
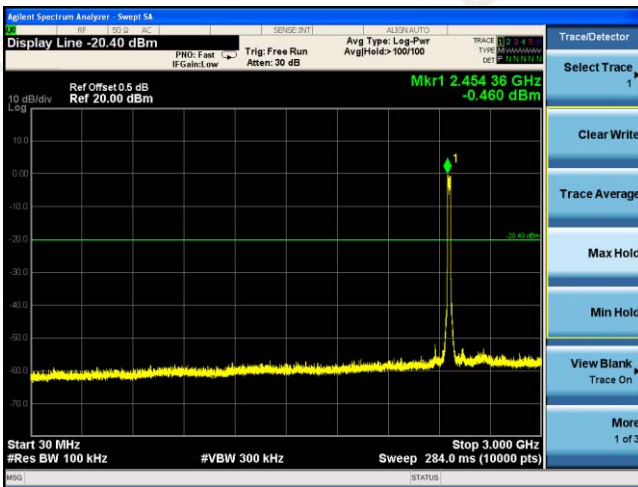

### CH11

### 802.11n(HT40)

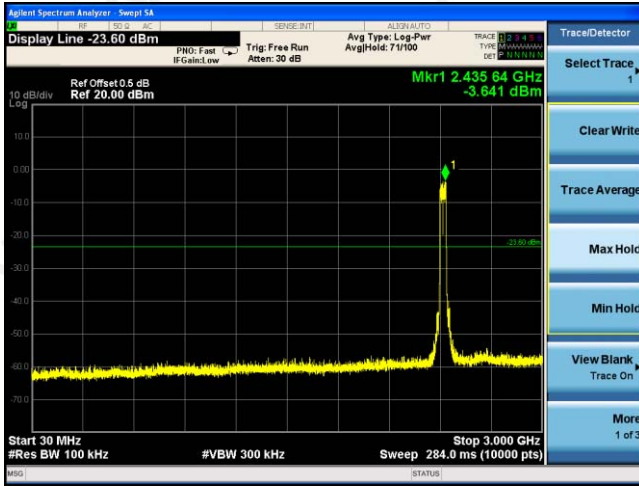

### CH03

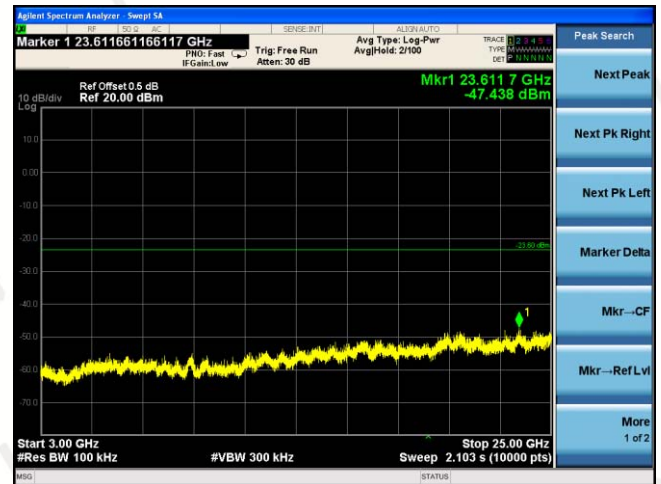
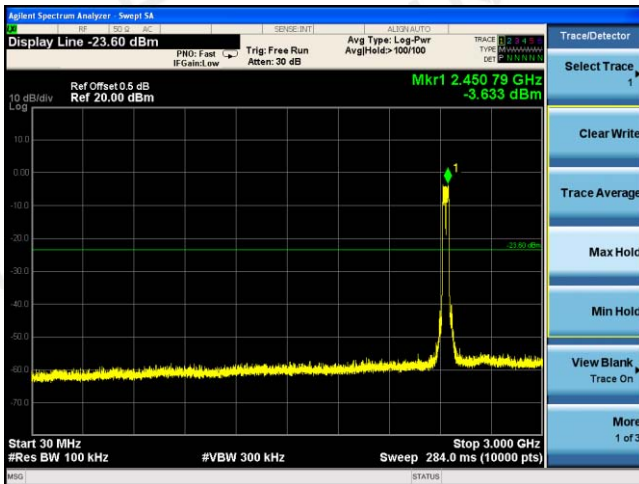

### CH06

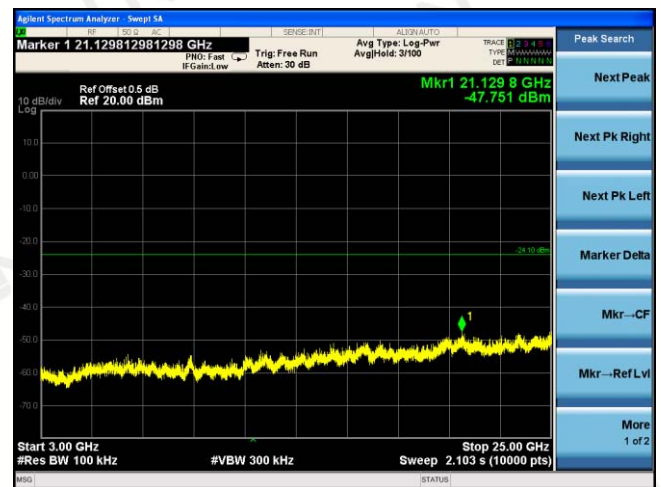
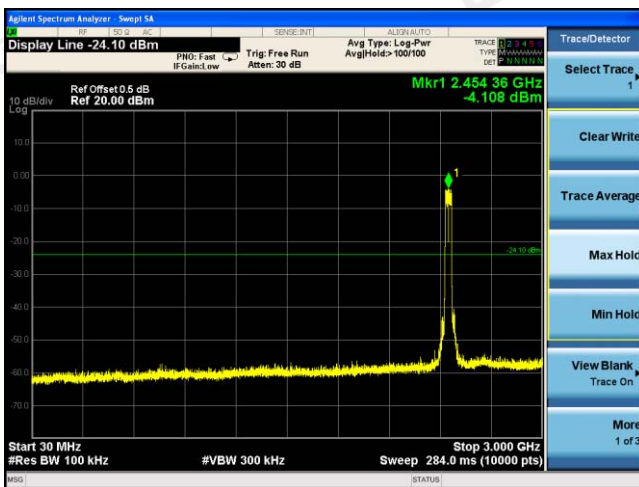

### CH09



**Band-edge Measurements for RF Conducted Emissions:**

**802.11b**

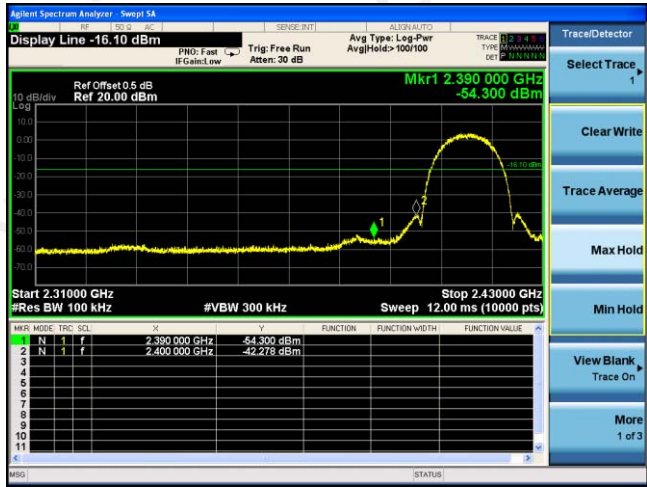

Left bandedge

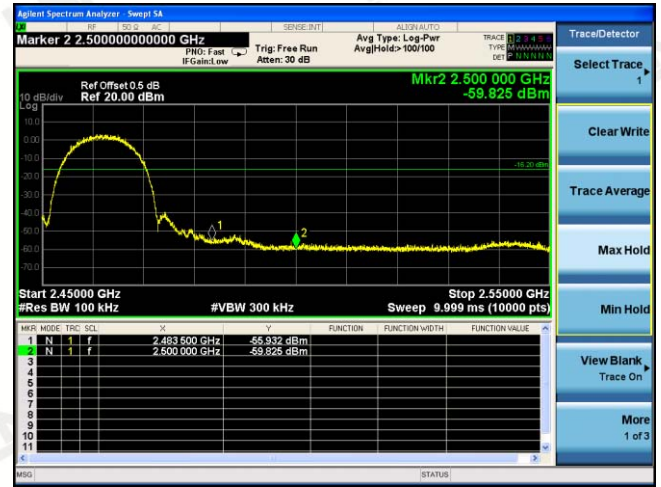

Right bandedge

**802.11g**

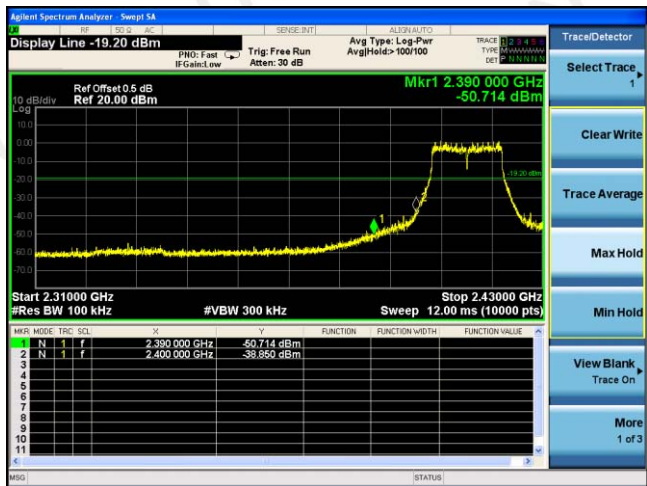

Left bandedge

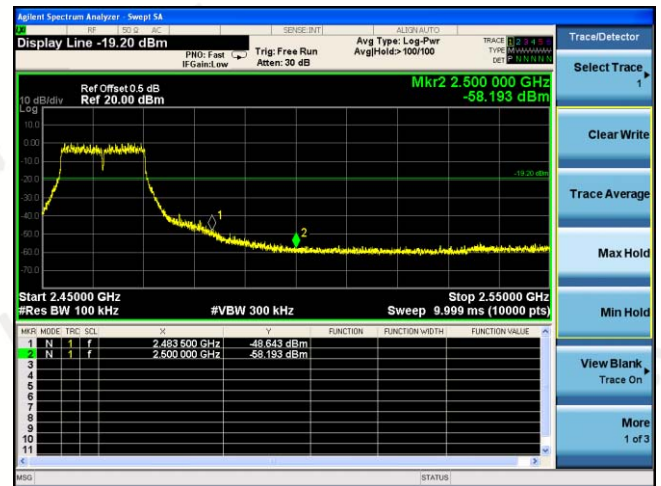

Right bandedge

### 802.11n(HT20)

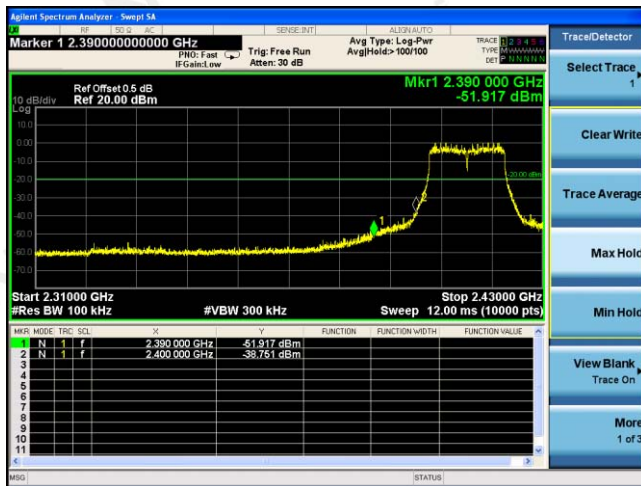

Left bandedge

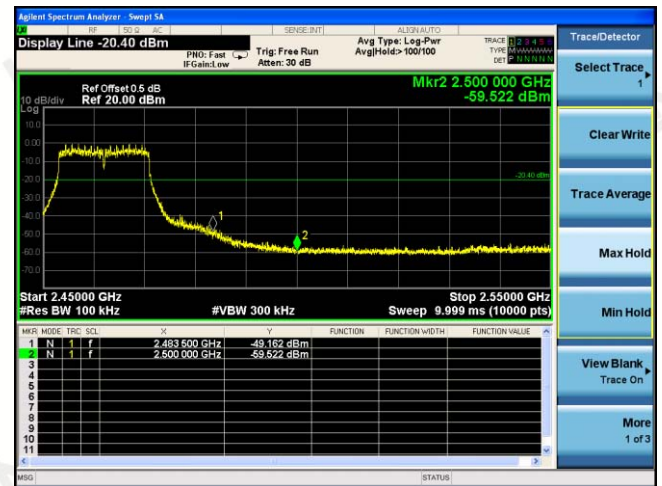

Right bandedge

### 802.11n(HT40)

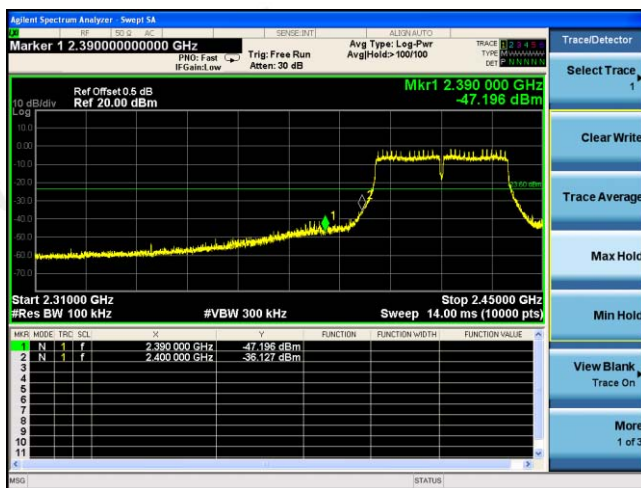

Left bandedge



Right bandedge

### 3.7 ANTENNA REQUIREMENT

**Standard Applicable:**

For intentional device, according to FCC 47 CFR Section 15.203, an intentional radiator shall be designed to ensure that no antenna other than that furnished by the responsible party shall be used with the device.

**Antenna Connected Construction**

The antenna used in this product is an Integral Antenna, the directional gains of antenna used for transmitting is 2.0dBi.

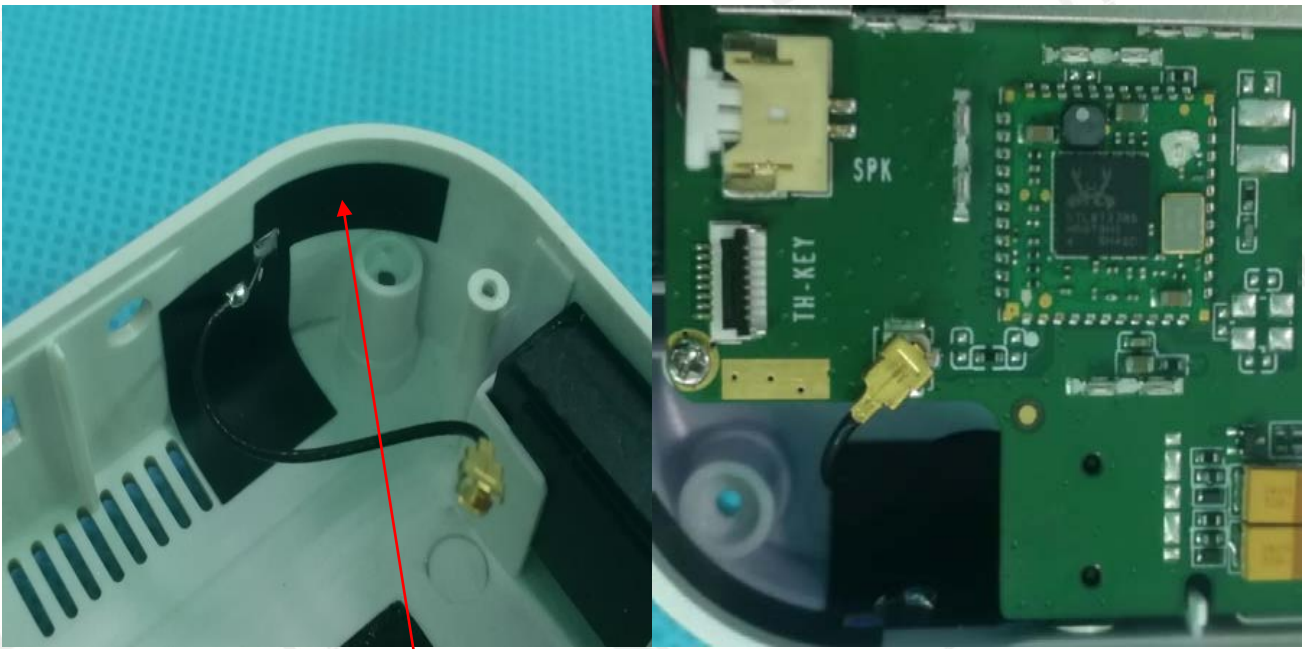

Antenna

#### 4 PHOTOGRAPH OF TEST

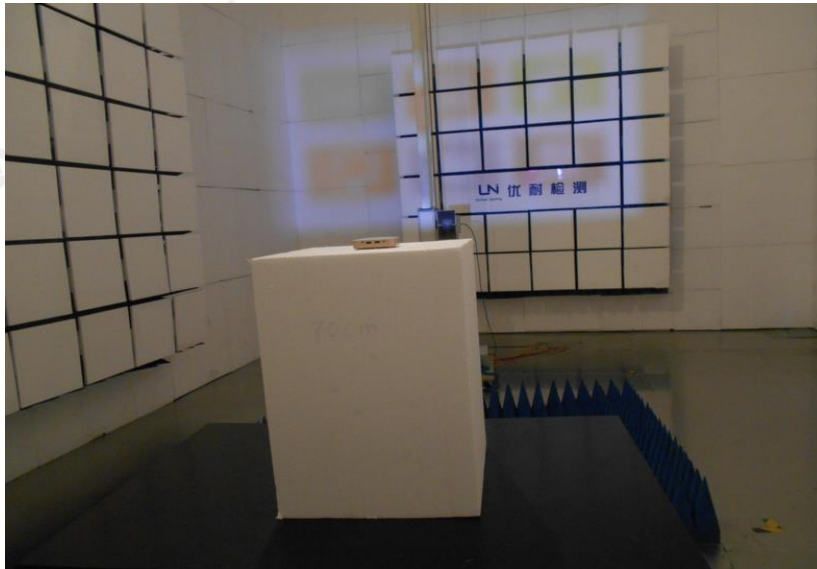
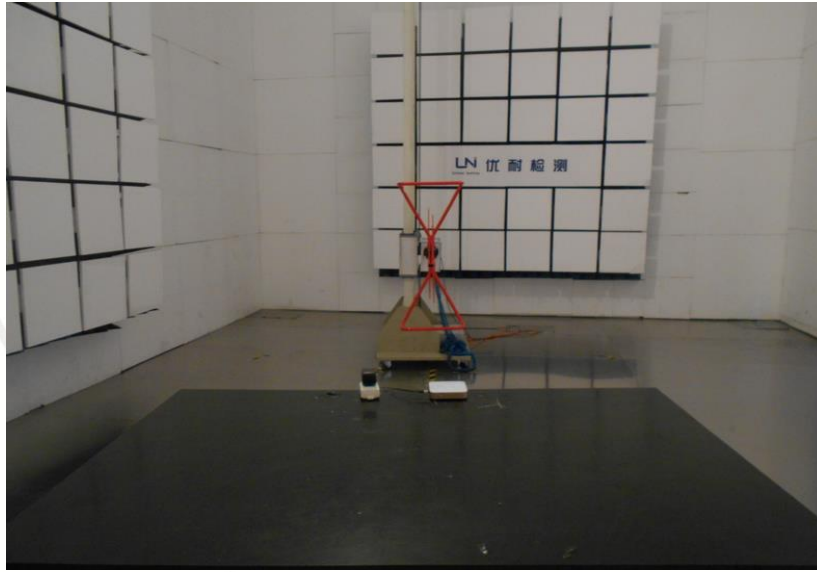

Conducted emission

## 5 PHOTOGRAPH OF EUT

### External photos

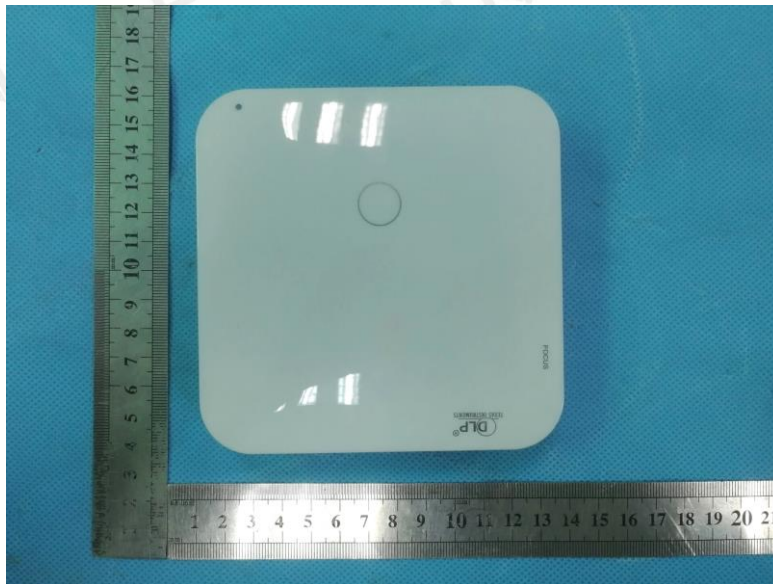



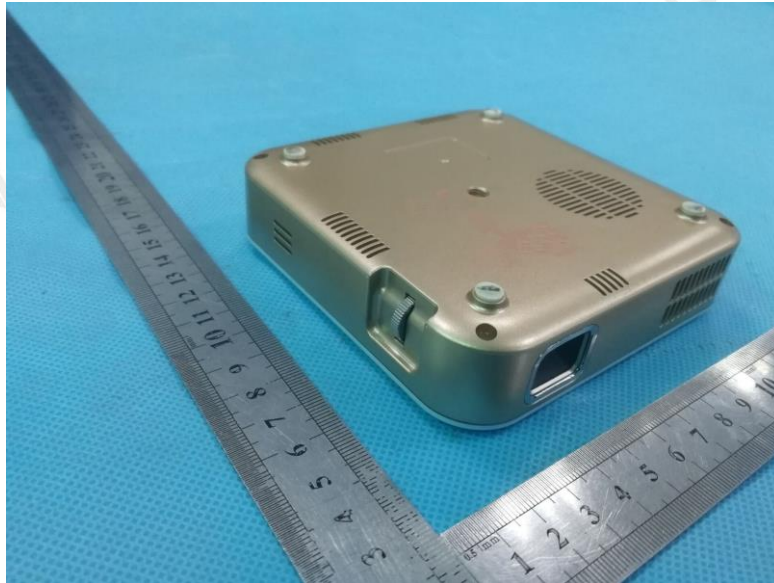





### Internal photos

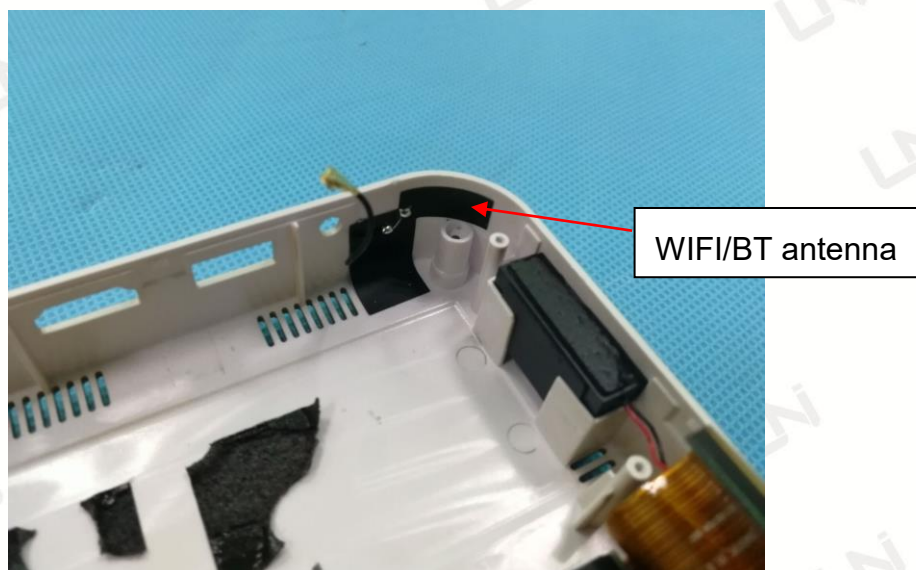

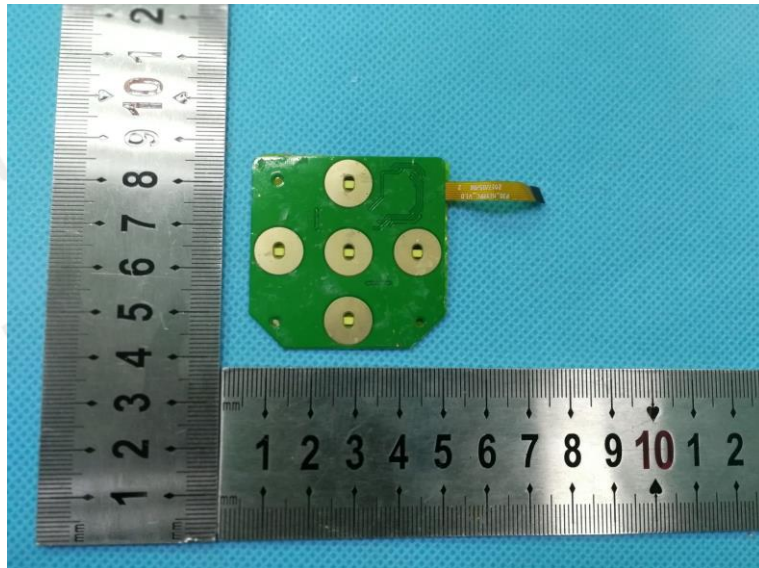
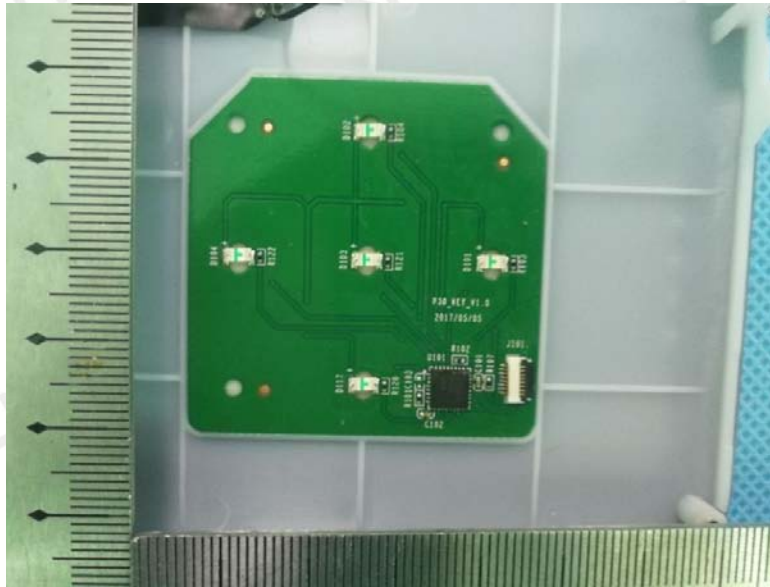

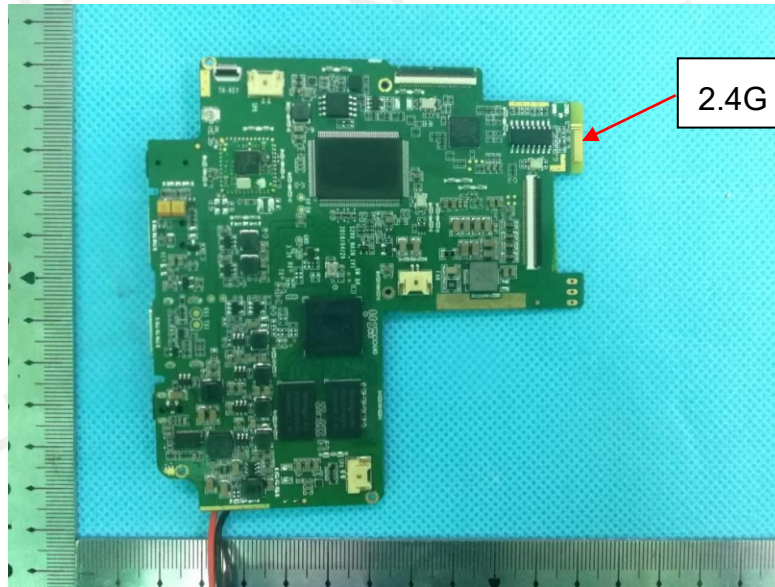

2.4G receiver antenna

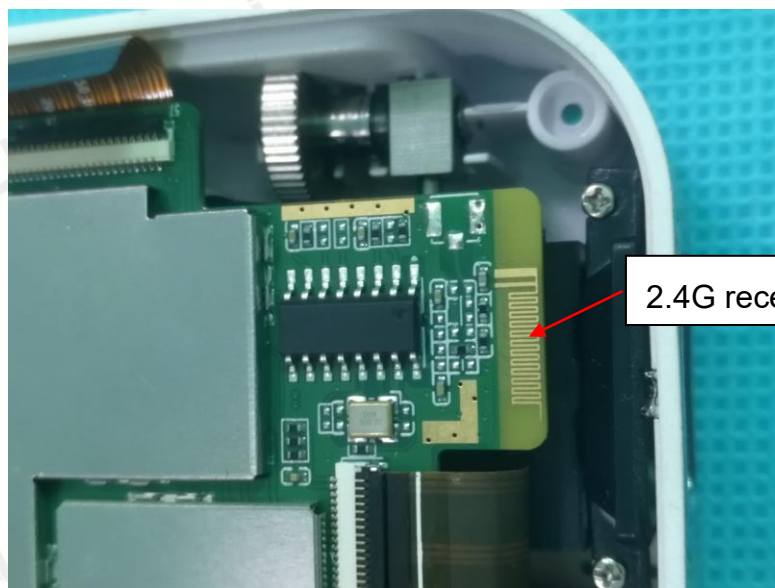

2.4G receiver antenna

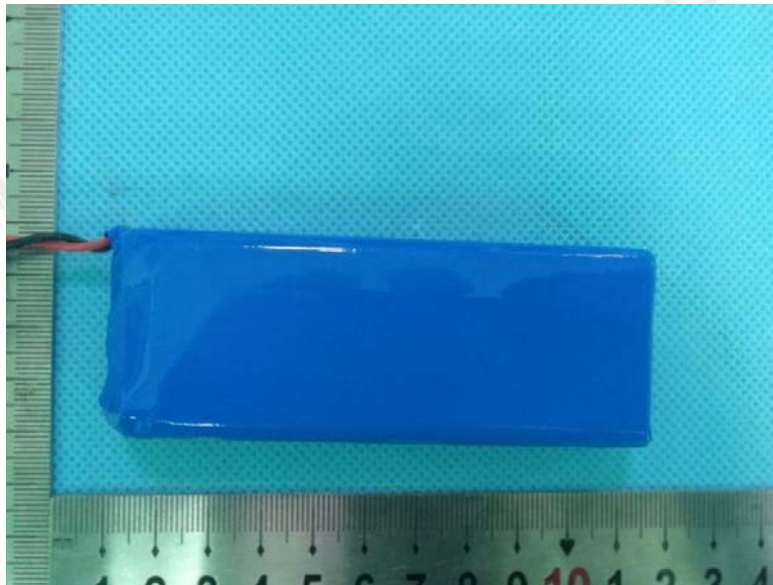

\*\*\*\*\*End of Report\*\*\*\*\*