

# FCC CERTIFICATION TEST REPORT

## FOR

|                             |   |  |
|-----------------------------|---|--|
| <b>Applicant</b>            | : | DC YunKe Networks Co.,Ltd.   |
| <b>Address</b>              | : | 6F, building B, no.777, guanggu no.3 road, east lake high-tech development zone, Wuhan China |
| <b>Equipment under Test</b> | : | Wall AP  |
| <b>Model No.</b>            | : | WL8200-WH2   |
| <b>Trade Mark</b>           | : | DCN  |
| <b>FCC ID</b>               | : | 2ARKXWL8200-WH2  |
| <b>Manufacturer</b>         | : | DC YunKe Networks Co.,Ltd.   |
| <b>Address</b>              | : | 6F, building B, no.777, guanggu no.3 road, east lake high-tech development zone, Wuhan China |

**Issued By: Dongguan Dongdian Testing Service Co., Ltd.**

**Add:** No. 17, Zongbu Road 2, Songshan Lake Sci&Tech, Industry Park,  
Dongguan City, Guangdong Province, China, 523808

**Tel:** +86-0769-38826678, **E-mail:** ddt@dgddt.com, <http://www.dgddt.com>

## TABLE OF CONTENTS

|      |   |    |
|------|---|----|
|      | Test report declares.....                         | 4  |
| 1.   | Summary of test results.....                      | 6  |
| 2.   | General test information .....                    | 7  |
| 2.1. | Description of EUT .....                          | 7  |
| 2.2. | Accessories of EUT .....                          | 7  |
| 2.3. | Assistant equipment used for test.....            | 7  |
| 2.4. | Block diagram of EUT configuration for test ..... | 8  |
| 2.5. | Deviations of test standard .....                 | 8  |
| 2.6. | Test environment conditions.....                  | 8  |
| 2.7. | Test laboratory.....                              | 8  |
| 2.8. | Measurement uncertainty .....                     | 9  |
| 3.   | Equipment used during test.....                   | 10 |
| 4.   | 6dB Bandwidth .....                               | 11 |
| 4.1. | Block diagram of test setup .....                 | 11 |
| 4.2. | Limits .....                                      | 11 |
| 4.3. | Test Procedure .....                              | 11 |
| 4.4. | Test Result .....                                 | 11 |
| 4.5. | original test data .....                          | 12 |
| 5.   | Conducted peak Output Power.....                  | 21 |
| 5.1. | Block diagram of test setup .....                 | 21 |
| 5.2. | Limits .....                                      | 21 |
| 5.3. | Test Procedure .....                              | 21 |
| 5.4. | Test Result .....                                 | 21 |
| 5.5. | original test data .....                          | 22 |
| 6.   | Power Spectral Density .....                      | 31 |
| 6.1. | Block diagram of test setup .....                 | 31 |
| 6.2. | Limits .....                                      | 31 |
| 6.3. | Test Procedure .....                              | 31 |
| 6.4. | Test Result .....                                 | 31 |
| 6.5. | original test data .....                          | 32 |
| 7.   | Band Edge and Spurious Emissions (Conducted)..... | 41 |
| 7.1. | Block diagram of test setup .....                 | 41 |
| 7.2. | Limits .....                                      | 41 |
| 7.3. | Test Procedure .....                              | 41 |
| 7.4. | Test Result .....                                 | 42 |
| 7.5. | original test data .....                          | 42 |
| 8.   | Radiated Spurious Emissions.....                  | 76 |
| 8.1. | Block diagram of test setup .....                 | 76 |

8.2. Limit.....77

8.3. Test Procedure .....78

8.4. Test result.....79

9. Radiated Band Edge Compliance.....84

9.1. Block diagram of test setup .....84

9.2. Limit.....84

9.3. Test Procedure .....84

9.4. Test result.....84

10. Power Line Conducted Emission.....101

10.1. Block diagram of test setup .....101

10.2. Power Line Conducted Emission Limits (Class B).....101

10.3. Test Procedure .....101

10.4. Test Result .....102

11. Antenna Requirements .....105

11.1. Limit.....105

11.2. Result .....105

## TEST REPORT DECLARE

|                             |   |  |
|-----------------------------|---|--|
| <b>Applicant</b>            | : | DC YunKe Networks Co.,Ltd.   |
| <b>Address</b>              | : | 6F, building B, no.777, guanggu no.3 road, east lake high-tech development zone, Wuhan China |
| <b>Equipment under Test</b> | : | Wall AP  |
| <b>Model No</b>             | : | WL8200-WH2   |
| <b>Trade Mark</b>           | : | DCN  |
| <b>Manufacturer</b>         | : | DC YunKe Networks Co.,Ltd.   |
| <b>Address</b>              | : | 6F, building B, no.777, guanggu no.3 road, east lake high-tech development zone, Wuhan China |

**Test Standard Used:** FCC Rules and Regulations Part 15 Subpart C

**Test procedure used:** ANSI C63.10:2013; 662911 D01 Multiple Transmitter Output v02r01

**We Declare:**

The equipment described above is tested by Dongguan Dongdian Testing Service Co., Ltd and in the configuration tested the equipment complied with the standards specified above. The test results are contained in this test report and Dongguan Dongdian Testing Service Co., Ltd is assumed of full responsibility for the accuracy and completeness of these tests.

**After test and evaluation, our opinion is that the equipment provided for test compliance with the requirement of the above FCC&IC standards.**

|                         |                   |                      |                               |
|-------------------------|-------------------|----------------------|-------------------------------|
| <b>Report No:</b>       | DDT-R18101003-1E4 |                      |                               |
| <b>Date of Receipt:</b> | Oct. 17, 2018     | <b>Date of Test:</b> | Oct. 17, 2018 ~ Dec. 25, 2018 |

**Prepared By:**

*Ella Gong*

**Ella Gong/Engineer**

**Approved By:**



**Damon Hu/EMC Manager**

Note: This report applies to above tested sample only. This report shall not be reproduced in parts without written approval of Dongguan Dongdian Testing Service Co., Ltd.

## Revision history

| Rev. | Revisions     | Issue Date    | Revised By |
|------|---------------|---------------|------------|
| ---  | Initial issue | Dec. 25, 2018 |            |
|      |               |               |            |

## 1. Summary of test results

| The EUT have been tested according to the applicable standards as referenced below. |  |         |
|---|--|---------|
| Description of Test Item  | Standard                                   | Results |
| 6dB Bandwidth   | FCC 15.247 (a) (2)                         | PASS    |
| Conducted Output Power  | FCC 15.247 (b) (3)                         | PASS    |
| Power Spectral Density  | FCC 15.247 (e)                             | PASS    |
| Band-edge and Spurious Emissions<br>(Conducted)                                     | FCC 15.247 (d)                             | PASS    |
| Radiated Spurious Emissions   | FCC 15.247 (d)<br>FCC 15.209<br>FCC 15.205 | PASS    |
| Radiated Band Edge Compliance   | FCC 15.247 (d)<br>FCC 15.209<br>FCC 15.205 | PASS    |
| Power Line Conducted Emission   | FCC 15.207                                 | PASS    |
| Antenna requirement   | FCC 15.203                                 | PASS    |
| Note: N/A is an abbreviation for Not Applicable.                                    |  |         |

## 2. General test information

### 2.1. Description of EUT

|                          |   |
|--------------------------|---|
| EUT* Name                | : Wall AP   |
| Model Number             | : WL8200-WH2  |
| EUT function description | : Please reference user manual of this device   |
| Power supply             | : DC 48V from network switch POE port input<br>DC 48V from AC Adapter   |
| Radio Technology         | : IEEE 802.11b/g/n  |
| FCC Operation frequency  | : IEEE 802.11b: 2412MHz-2462MHz<br>IEEE 802.11g: 2412MHz-2462MHz<br>IEEE 802.11n HT20: 2412MHz-2462MHz<br>IEEE 802.11n HT40: 2422MHz-2452MHz  |
| Modulation               | : IEEE 802.11b: DSSS (CCK, QPSK, BPSK)<br>IEEE 802.11g: OFDM (64QAM, 16QAM, QPSK, BPSK)<br>IEEE 802.11n HT20, HT40: OFDM (64QAM, 16QAM, QPSK, BPSK)   |
| Transmitter rate         | : IEEE 802.11b: 1, 2, 5.5, 11 Mbps<br>IEEE 802.11g: 6, 9, 12, 18, 24, 36, 48, 54 Mbps<br>IEEE 802.11n HT20: 6.5, 13, 19.5, 26, 39, 52, 58.5, 65, 78, 104, 117, 130 Mbps<br>IEEE 802.11n HT40: 13.5, 27, 40.5, 54, 81, 108, 121.5, 135, 162, 216, 243, 270 Mbps  |
| Antenna Type             | : Antenna 1: Internal antenna, maximum PK gain: 3 dBi<br>Antenna 2: Internal antenna, maximum PK gain: 3 dBi<br>The EUT incorporates a MIMO function. Physically, it provides two completed transmitters and receivers(2T2R), two transmit signals are completely uncorrelated, then, Direction gain=GANT |
| Sample Type              | : Series production   |

Note: EUT is the ab. of equipment under test.

| Channel information |           |    |           |    |           |    |           |
|---------------------|-----------|----|-----------|----|-----------|----|-----------|
| CH                  | Frequency | CH | Frequency | CH | Frequency | CH | Frequency |
| 1                   | 2412      | 5  | 2432      | 9  | 2452      | /  | /         |
| 2                   | 2417      | 6  | 2437      | 10 | 2457      | /  | /         |
| 3                   | 2422      | 7  | 2442      | 11 | 2462      | /  | /         |
| 4                   | 2427      | 8  | 2447      | /  | /         | /  | /         |

### 2.2. Accessories of EUT

| Description of Accessories | Manufacturer | Model number | Serial No. | Other |
|----------------------------|--------------|--------------|------------|-------|
| N/A                        | N/A          | N/A          | N/A        | N/A   |

### 2.3. Assistant equipment used for test

| Assistant equipment | Manufacturer | Model number  | EMC Compliance | SN                |
|---------------------|--------------|---------------|----------------|-------------------|
| Notebook            | DELL         | Latitude D610 | FCC DOC        | 00045-534-136-300 |

## 2.4. Block diagram of EUT configuration for test

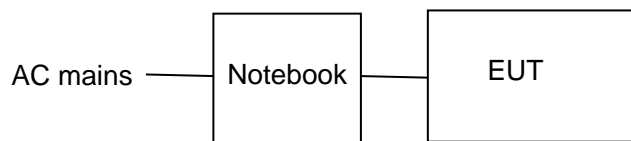

EUT was connected to control provided by manufacturer which has a standard LAN PORT connector connected to Notebook, and the Notebook will run a special test software “artgui.EXE” provided by manufacturer that control EUT work in Continuous Tx mode (>98% duty cycle), and select test channel, wireless mode and data rate.

| Tested mode, channel, and data rate information |                  |                                |           |                 |
|---|------------------|--------------------------------|-----------|-----------------|
| Mode  | Setting Tx Power | data rate (Mbps)<br>(see Note) | Channel   | Frequency (MHz) |
| IEEE 802.11b                                    | 26               | 1                              | LCH: CH1  | 2412            |
|   | 26               | 1                              | MCH: CH6  | 2437            |
|   | 25               | 1                              | HCH: CH11 | 2462            |
| IEEE 802.11g                                    | 25               | 6                              | LCH: CH1  | 2412            |
|   | 24               | 6                              | MCH: CH6  | 2437            |
|   | 23               | 6                              | HCH: CH11 | 2462            |
| IEEE 802.11n HT20                               | 22               | MCS 8                          | LCH: CH1  | 2412            |
|   | 23               | MCS 8                          | MCH: CH6  | 2437            |
|   | 22               | MCS 8                          | HCH: CH11 | 2462            |
| IEEE 802.11n HT40                               | 20               | MCS 8                          | LCH: CH3  | 2422            |
|   | 20               | MCS 8                          | MCH: CH6  | 2437            |
|   | 20               | MCS 8                          | HCH: CH9  | 2452            |

Note: According exploratory test, EUT will have maximum output power in those data rate, so those data rate were used for all test.

## 2.5. Deviations of test standard

No Deviation/

## 2.6. Test environment conditions

During the measurement the environmental conditions were within the listed ranges:

|                    |           |
|--------------------|-----------|
| Temperature range: | 21-25°C   |
| Humidity range:    | 40-75%    |
| Pressure range:    | 86-106kPa |

## 2.7. Test laboratory

Dongguan Dongdian Testing Service Co., Ltd.

Add: No. 17, Zongbu Road 2, Songshan Lake Sci&Tech, Industry Park, Dongguan City, Guangdong Province, China, 523808



Tel: +86-0769-38826678, <http://www.dgddt.com>, Email: ddt@dgddt.com

CNAS Accreditation No. L6451; A2LA Accreditation No. 3870.01

FCC Designation Number: CN1182; FCC Test Firm Registration Number: 540522

Industry Canada site registration number: 10288A-1

## 2.8. Measurement uncertainty

| Test Item   | Uncertainty                                    |
|---|--|
| Bandwidth   | 1.1%   |
| Peak Output Power (Conducted) (Spectrum analyzer)   | 0.86dB (10 MHz ≤ f < 3.6GHz);                  |
|   | 1.38dB (3.6GHz ≤ f < 8GHz)                     |
| Peak Output Power (Conducted) (Power Sensor)  | 0.74dB   |
| Power Spectral Density  | 0.74dB (10 MHz ≤ f < 3.6GHz);                  |
|   | 1.38dB (3.6GHz ≤ f < 8GHz)                     |
| Frequencies Stability   | 6.7 x 10 <sup>-8</sup> (Antenna couple method) |
|   | 5.5 x 10 <sup>-8</sup> (Conducted method)      |
| Conducted spurious emissions  | 0.86dB (10 MHz ≤ f < 3.6GHz);                  |
|   | 1.40dB (3.6GHz ≤ f < 8GHz)                     |
|   | 1.66dB (8GHz ≤ f < 22GHz)                      |
| Uncertainty for radio frequency (RBW<20kHz)   | 3x10 <sup>-8</sup>                             |
| Temperature   | 0.4°C  |
| Humidity  | 2%   |
| Uncertainty for Radiation Emission test<br>(30MHz-1GHz)   | 4.70 dB (Antenna Polarize: V)                  |
|   | 4.84 dB (Antenna Polarize: H)                  |
| Uncertainty for Radiation Emission test<br>(1GHz-40GHz)   | 4.10dB (1-6GHz)                                |
|   | 4.40dB (6GHz-18GHz)                            |
|   | 3.54dB (18GHz-26GHz)                           |
|   | 4.30dB (26GHz-40GHz)                           |
| Uncertainty for Power line conduction emission test   | 3.32dB (150kHz-30MHz)                          |
| Note: This uncertainty represents an expanded uncertainty expressed at approximately the 95% confidence level using a coverage factor of k=2. |  |

### 3. Equipment used during test

| Equipment   | Manufacturer                          | Model No.          | Serial No.        | Last Cal.     | Cal. Interval |
|---|---------------------------------------|--------------------|-------------------|---------------|---------------|
| <b>RF Connected Test (Tonscend RF Measurement System)</b> |                                       |                    |                   |               |               |
| Spectrum analyzer   | R&S                                   | FSU26              | 200071            | Oct. 12, 2018 | 1 Year        |
| Wideband Radio Communication tester                       | R&S                                   | CMW500             | 117491            | Jun. 29, 2018 | 1 Year        |
| Vector Signal Generator                                   | Agilent                               | E8267D             | US49060192        | Oct. 12, 2018 | 1 Year        |
| Vector Signal Generator                                   | Agilent                               | N5182A             | MY48180737        | Jun. 29, 2018 | 1 Year        |
| Power Sensor  | Agilent                               | U2021XA            | MY55150010        | Oct. 21, 2018 | 1 Year        |
| Power Sensor  | Agilent                               | U2021XA            | MY55150011        | Oct. 23, 2018 | 1 Year        |
| DC Power Source   | Ouyuan electronic technology co., LTD | ADC50-20           | 990406            | Oct. 12, 2018 | 1 Year        |
| Attenuator  | Mini-Circuits                         | BW-S10W2           | 101109            | Aug. 18, 2018 | 1 Year        |
| RF Cable  | Micable                               | C10-01-01-1        | 100309            | Oct. 21, 2018 | 1 Year        |
| Temp&Humi Programmable                                    | ZHIXIANG                              | ZXGDJS-150L        | ZX170110-A        | Oct. 21, 2018 | 1 Year        |
| Test Software   | JS Tonscend                           | JS1120-3           | Ver.2.7           | N/A           | N/A           |
| <b>Radiation 1#chamber</b>                                |                                       |                    |                   |               |               |
| EMI Test Receiver   | R&S                                   | ESU8               | 100316            | Oct. 12, 2018 | 1 Year        |
| Spectrum analyzer   | Agilent                               | E4447A             | MY50180031        | Jun. 29, 2018 | 1 Year        |
| Trilog Broadband Antenna                                  | Schwarzbeck                           | VULB9163           | 9163-462          | Nov. 09, 2018 | 1 Year        |
| Active Loop antenna                                       | Schwarzbeck                           | FMZB-1519          | 1519-038          | Oct. 20, 2018 | 1 Year        |
| Double Ridged Horn Antenna                                | R&S                                   | HF907              | 100276            | Nov. 16, 2018 | 1 Year        |
| Broad Band Horn Antenna                                   | Schwarzbeck                           | BBHA 9170          | 790               | Oct. 25, 2018 | 1 Year        |
| Pre-amplifier   | TERA-MW                               | TRLA-0040 G35      | 101303            | Oct. 12, 2018 | 1 Year        |
| RF Cable  | HUBSER                                | CP-X2+ CP-X1       | W11.03+ W12.02    | Oct. 21, 2018 | 1 Year        |
| RF Cable  | N/A                                   | SMAJ-SMA J-1M+ 11M | 17070133+17070131 | Nov. 08, 2018 | 1 Year        |
| MI Cable  | HUBSER                                | C10-01-01-1 M      | 1091629           | Oct. 21, 2018 | 1 Year        |
| Test software   | Audix                                 | E3                 | V 6.11111b        | N/A           | N/A           |
| <b>Power Line Conducted Emissions Test</b>                |                                       |                    |                   |               |               |
| Test Receiver   | R&S                                   | ESU8               | 100316            | Oct. 12, 2018 | 1 Year        |
| LISN 1  | R&S                                   | ENV216             | 101109            | Oct. 12, 2018 | 1 Year        |
| LISN 2  | R&S                                   | ESH2-Z5            | 100309            | Oct. 12, 2018 | 1 Year        |
| Pulse Limiter   | R&S                                   | ESH3-Z2            | 101242            | Oct. 12, 2018 | 1 Year        |
| CE Cable 1  | HUBSER                                | ESU8/RF2           | W10.01            | Oct. 12, 2018 | 1 Year        |
| Test software   | Audix                                 | E3                 | V 6.11111b        | N/A           | N/A           |

## 4. 6dB Bandwidth

### 4.1. Block diagram of test setup

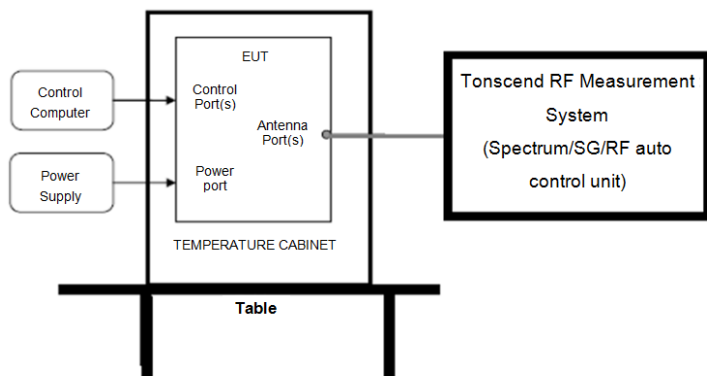

### 4.2. Limits

For direct sequence systems, the minimum 6dB bandwidth shall be at least 500 kHz

### 4.3. Test Procedure

- (1) Connect EUT’s antenna output to spectrum analyzer by RF cable.
- (2) Set the spectrum analyzer as follows:
  - RBW: 100kHz
  - VBW: 300kHz
  - Detector Mode: Peak
  - Sweep time: auto
  - Trace mode Max hold
- (3) Allow the trace to stabilize, measure the maximum width of the emission that is constrained by the frequencies associated with the two outermost amplitude points (upper and lower frequencies) that are attenuated by 6 dB relative to the maximum level measured in the fundamental emission.

### 4.4. Test Result

| Test Mode | Test Channel [MHz] | Ant  | 6dB Bandwidth [MHz] | Limit [MHz] | Verdict |
|-----------|--------------------|------|---------------------|-------------|---------|
| 11B       | 2412               | ANT1 | 7.160               | 0.5         | PASS    |
| 11B       | 2437               | ANT1 | 6.160               | 0.5         | PASS    |
| 11B       | 2462               | ANT1 | 6.640               | 0.5         | PASS    |
| 11G       | 2412               | ANT1 | 15.080              | 0.5         | PASS    |
| 11G       | 2437               | ANT1 | 15.360              | 0.5         | PASS    |
| 11G       | 2462               | ANT1 | 12.080              | 0.5         | PASS    |
| 11N20MIMO | 2412               | ANT1 | 12.720              | 0.5         | PASS    |
| 11N20MIMO | 2412               | ANT2 | 15.160              | 0.5         | PASS    |
| 11N20MIMO | 2437               | ANT1 | 15.200              | 0.5         | PASS    |
| 11N20MIMO | 2437               | ANT2 | 15.160              | 0.5         | PASS    |

|           |      |      |        |     |      |
|-----------|------|------|--------|-----|------|
| 11N20MIMO | 2462 | ANT1 | 13.920 | 0.5 | PASS |
| 11N20MIMO | 2462 | ANT2 | 15.160 | 0.5 | PASS |
| 11N40MIMO | 2422 | ANT1 | 35.200 | 0.5 | PASS |
| 11N40MIMO | 2422 | ANT2 | 35.200 | 0.5 | PASS |
| 11N40MIMO | 2437 | ANT1 | 34.000 | 0.5 | PASS |
| 11N40MIMO | 2437 | ANT2 | 35.200 | 0.5 | PASS |
| 11N40MIMO | 2452 | ANT1 | 34.000 | 0.5 | PASS |
| 11N40MIMO | 2452 | ANT2 | 31.440 | 0.5 | PASS |

4.5. original test data

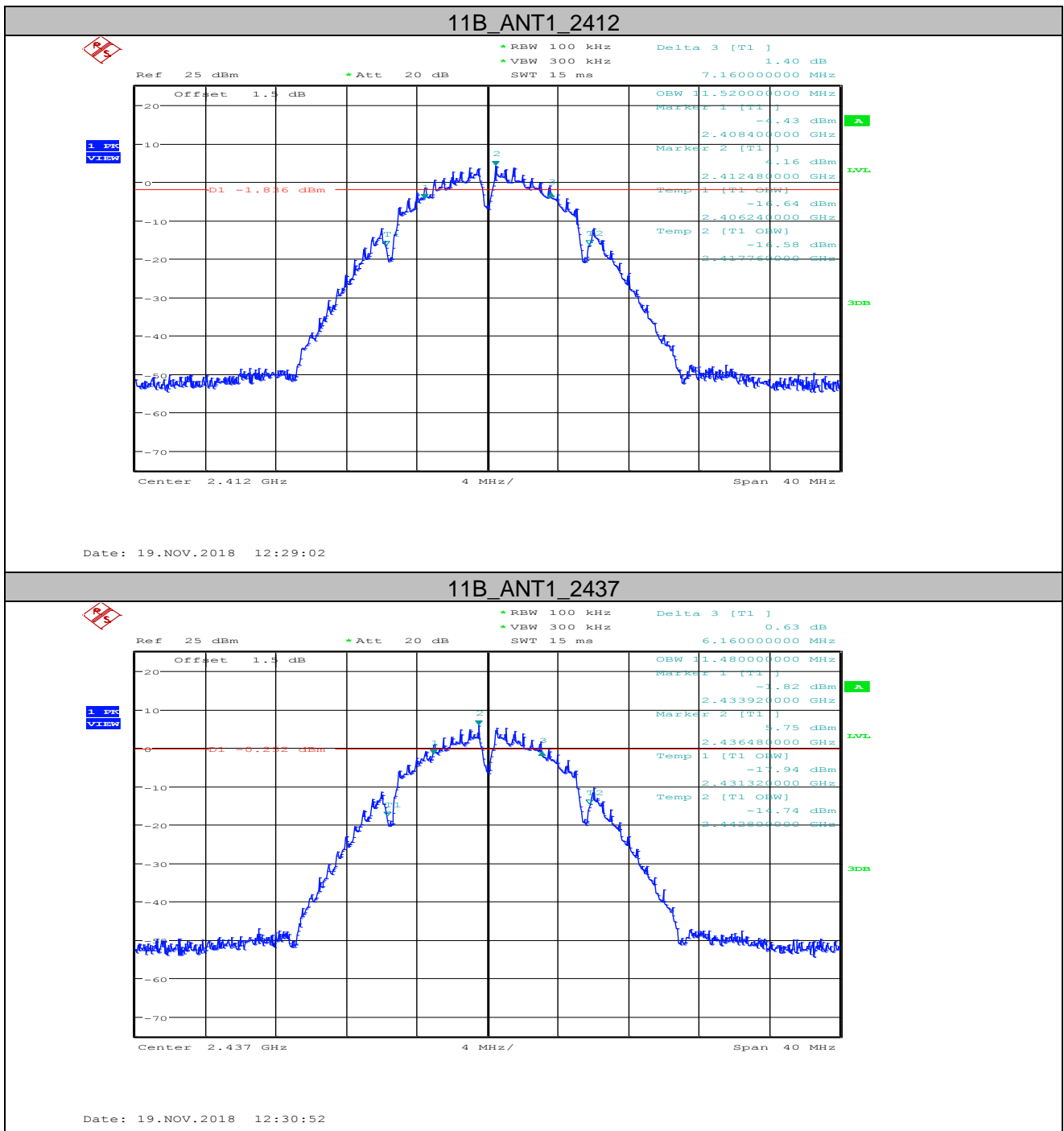

### 11B\_ANT1\_2462

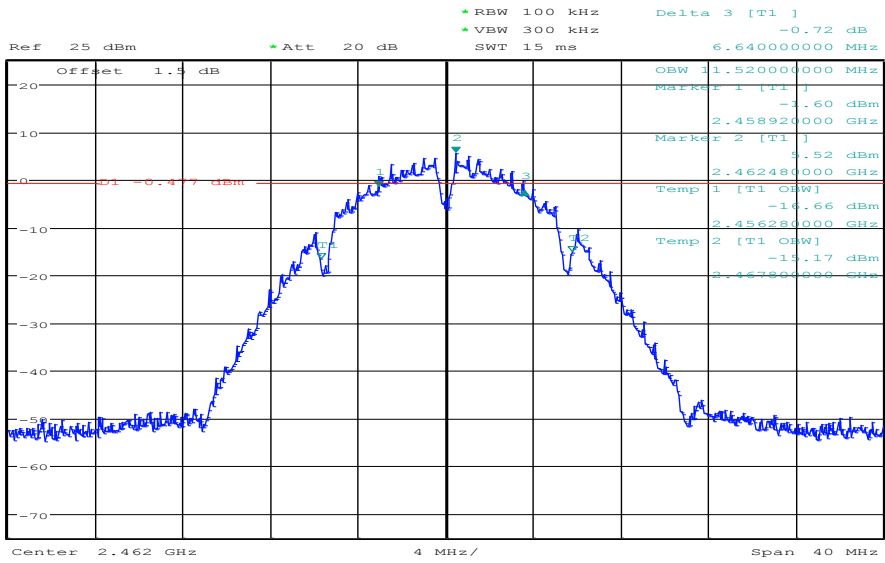

Date: 19.NOV.2018 12:32:20

### 11G\_ANT1\_2412

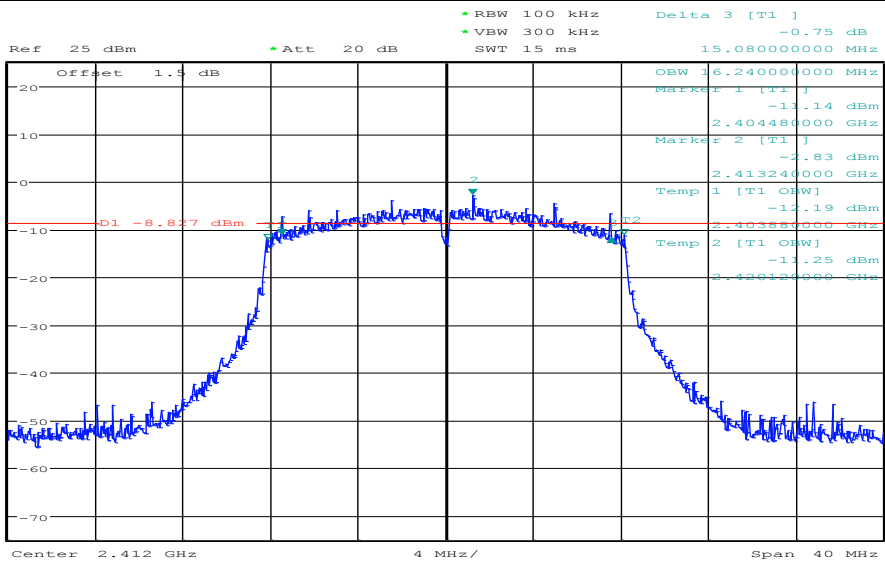

Date: 19.NOV.2018 12:36:32

### 11G\_ANT1\_2437

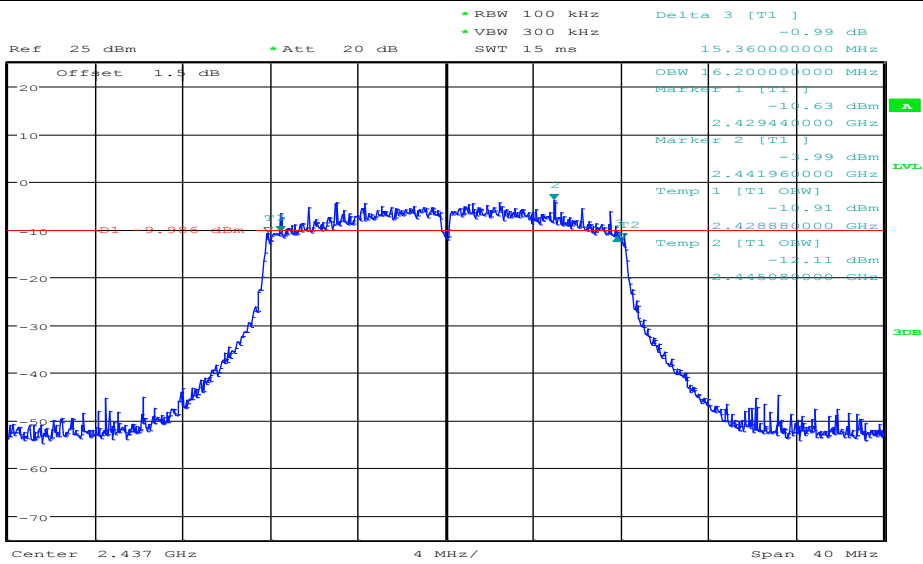

Date: 19.NOV.2018 12:37:53

11G\_ANT1\_2462

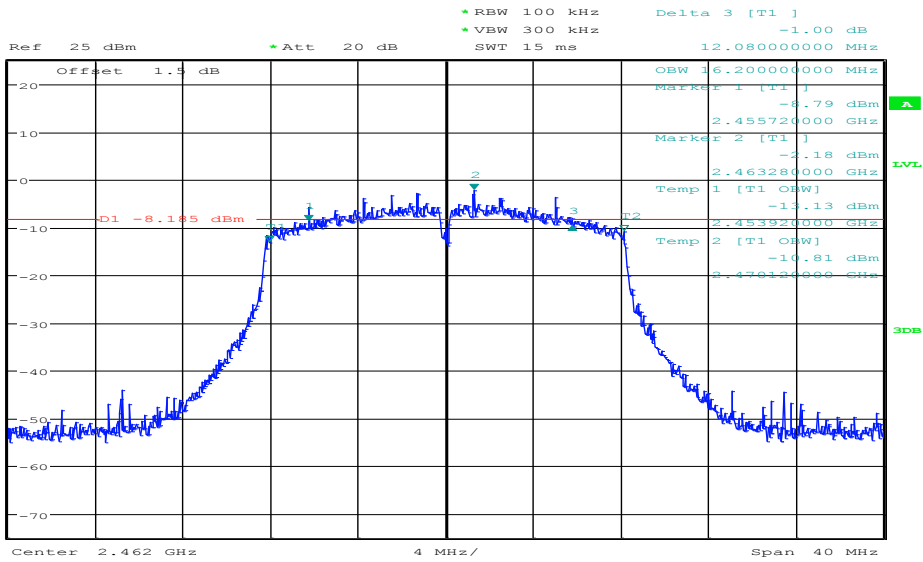

Date: 19.NOV.2018 12:39:20

11N20MIMO\_ANT1\_2412

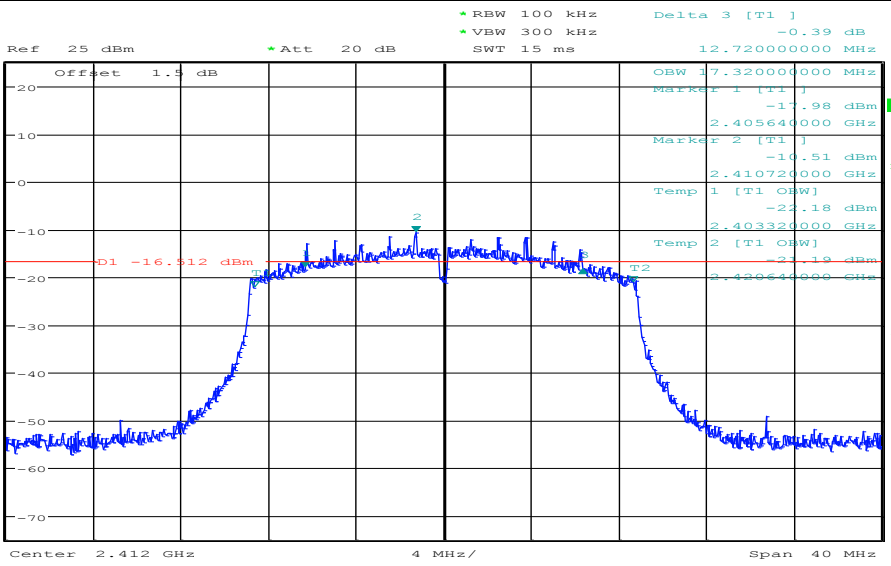

Date: 19.NOV.2018 12:54:38

11N20MIMO\_ANT2\_2412

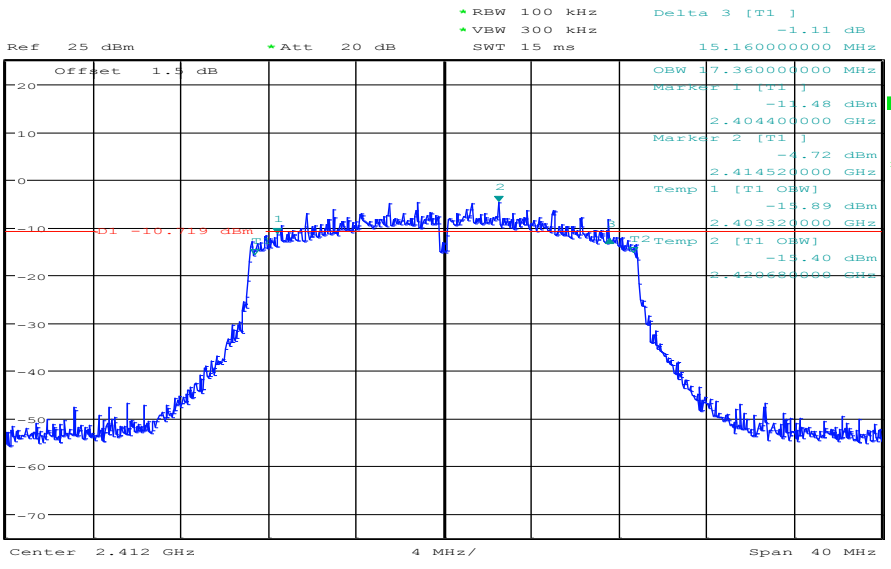

Date: 19.NOV.2018 13:00:48

11N20MIMO\_ANT1\_2437

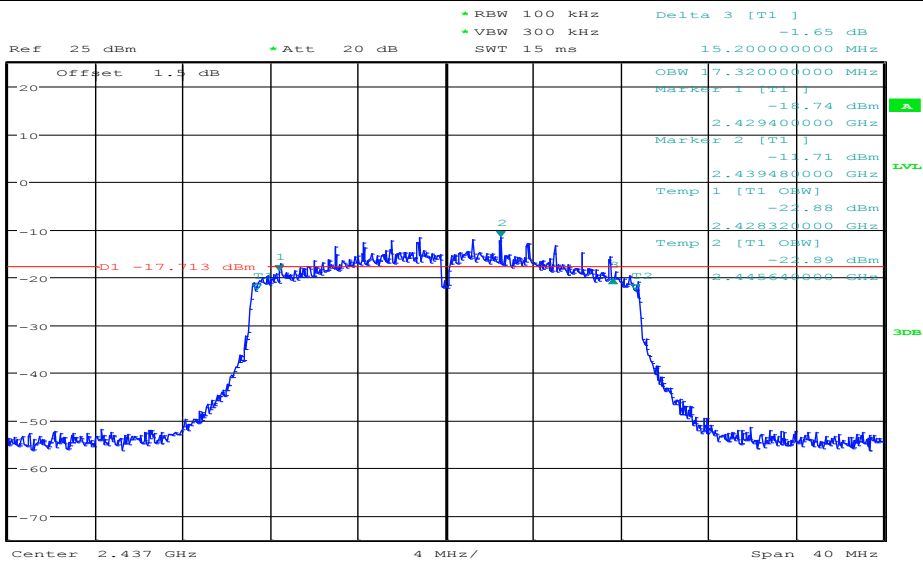

Date: 19.NOV.2018 12:56:15

11N20MIMO\_ANT2\_2437

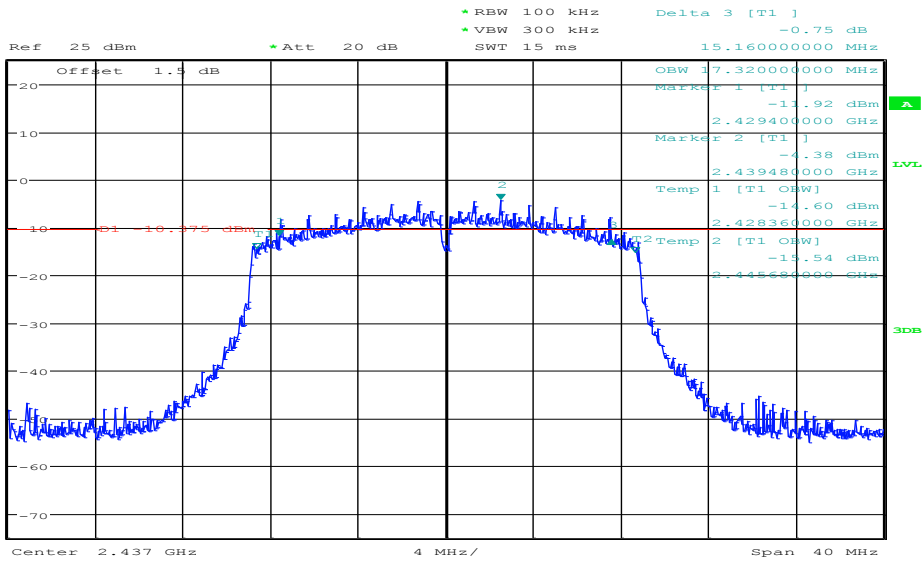

Date: 19.NOV.2018 13:02:23

11N20MIMO\_ANT1\_2462



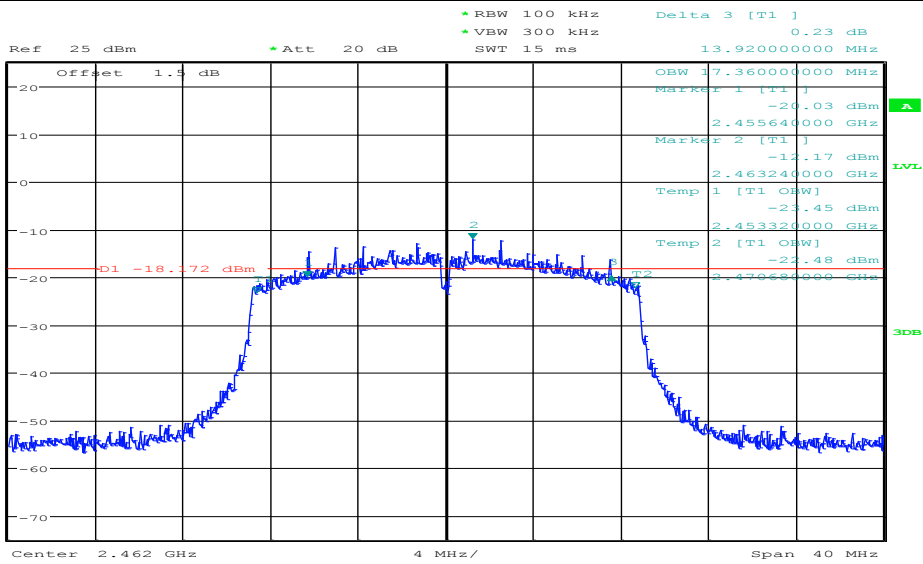

Date: 19.NOV.2018 12:58:14

11N20MIMO\_ANT2\_2462

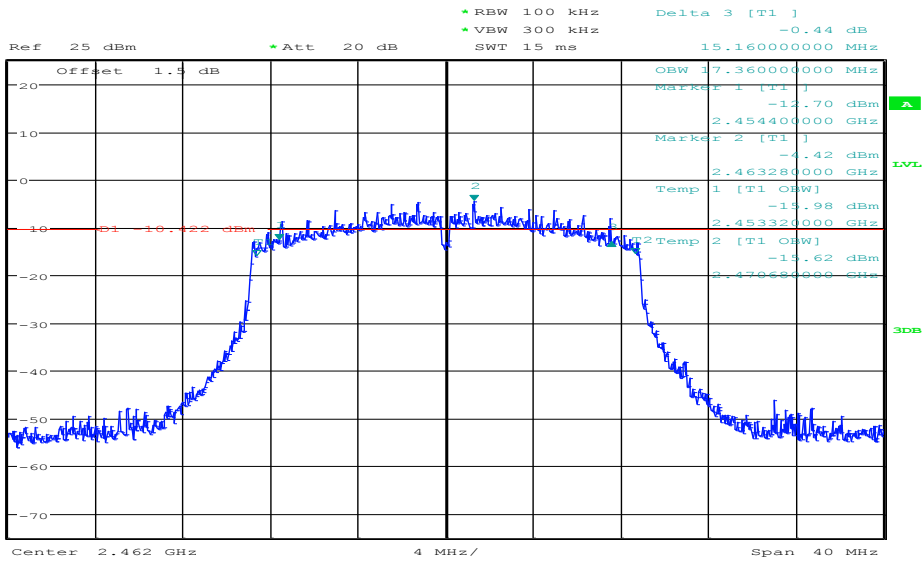

Date: 19.NOV.2018 13:04:40

11N40MIMO\_ANT1\_2422

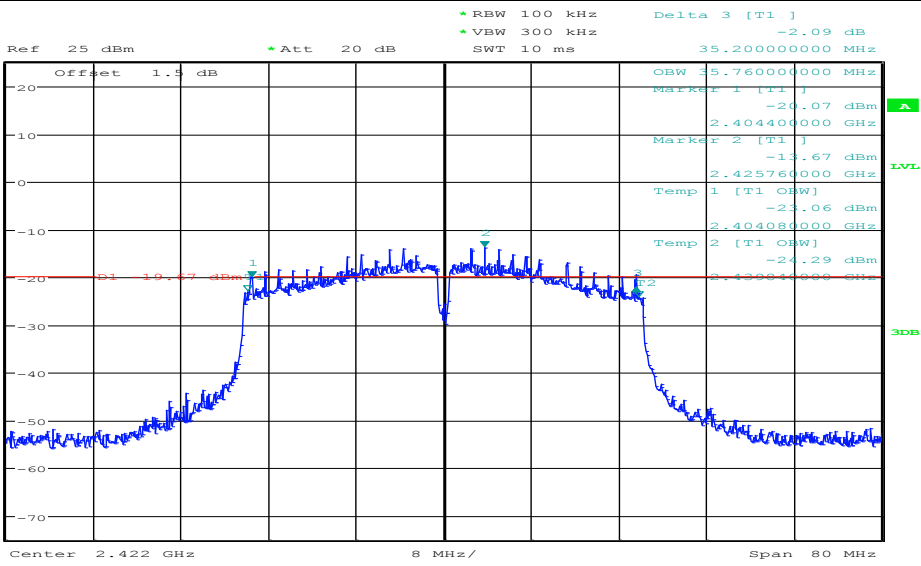

Date: 19.NOV.2018 13:09:57

11N40MIMO\_ANT2\_2422

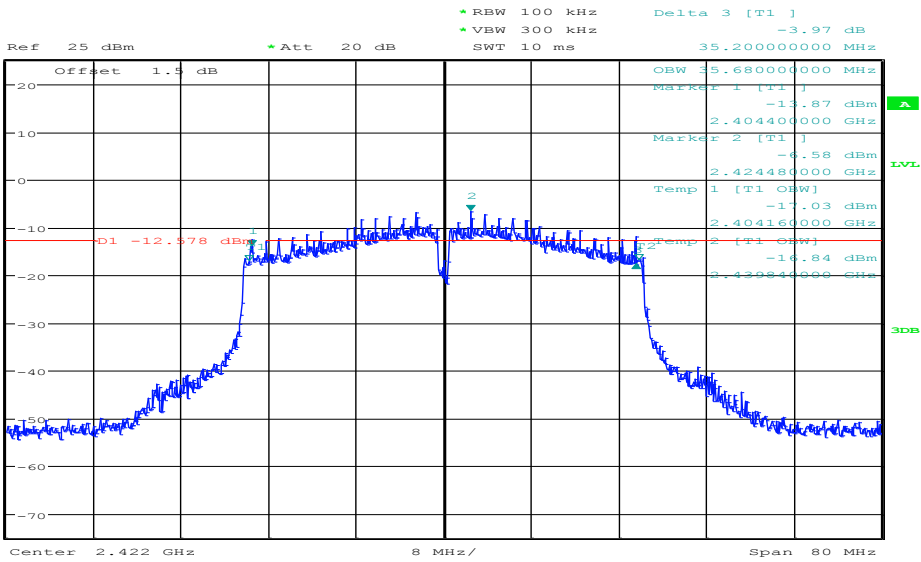

Date: 19.NOV.2018 13:17:31

11N40MIMO\_ANT1\_2437

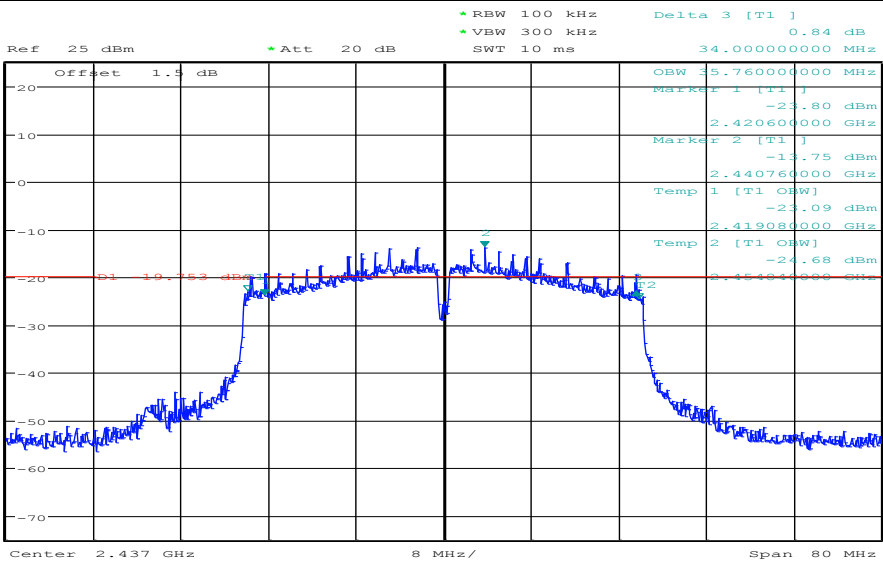

Date: 19.NOV.2018 13:12:28

11N40MIMO\_ANT2\_2437

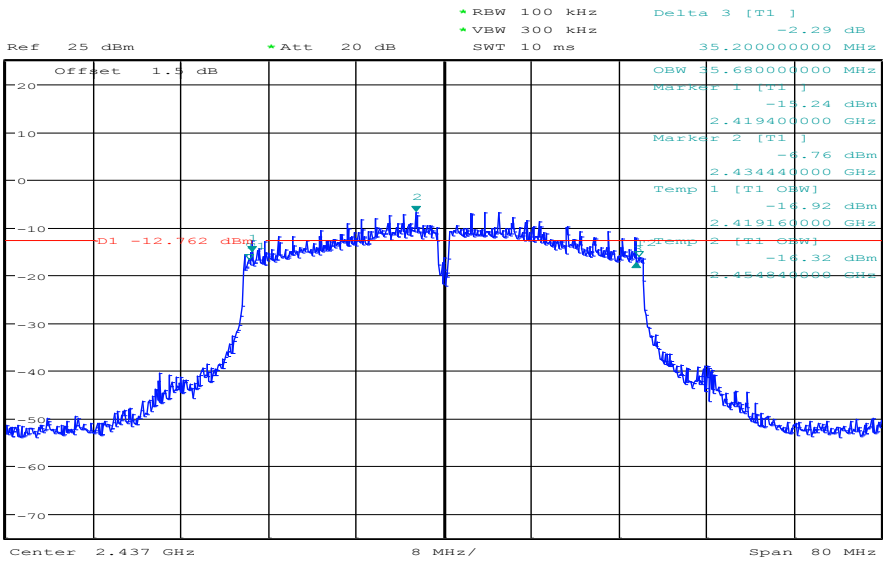

Date: 19.NOV.2018 13:19:22

11N40MIMO\_ANT1\_2452

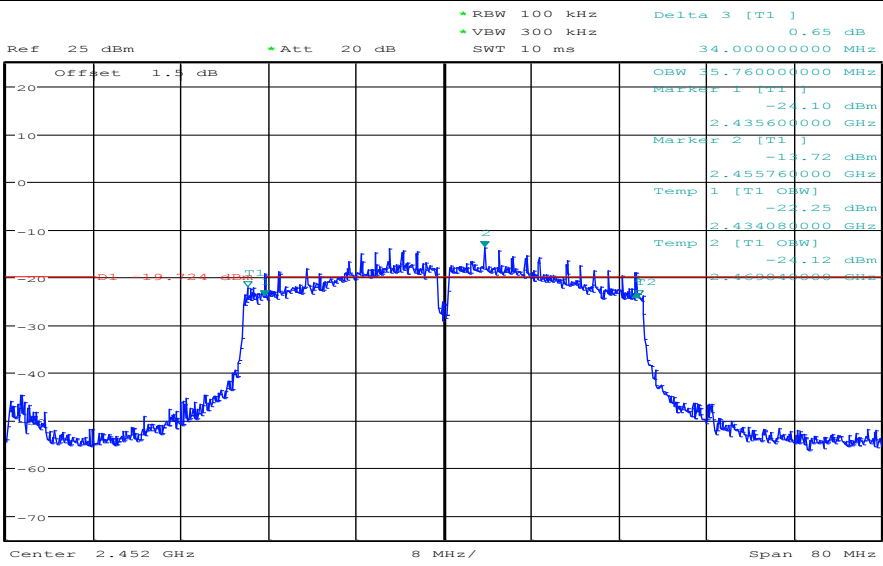

Date: 19.NOV.2018 13:14:45

11N40MIMO\_ANT2\_2452

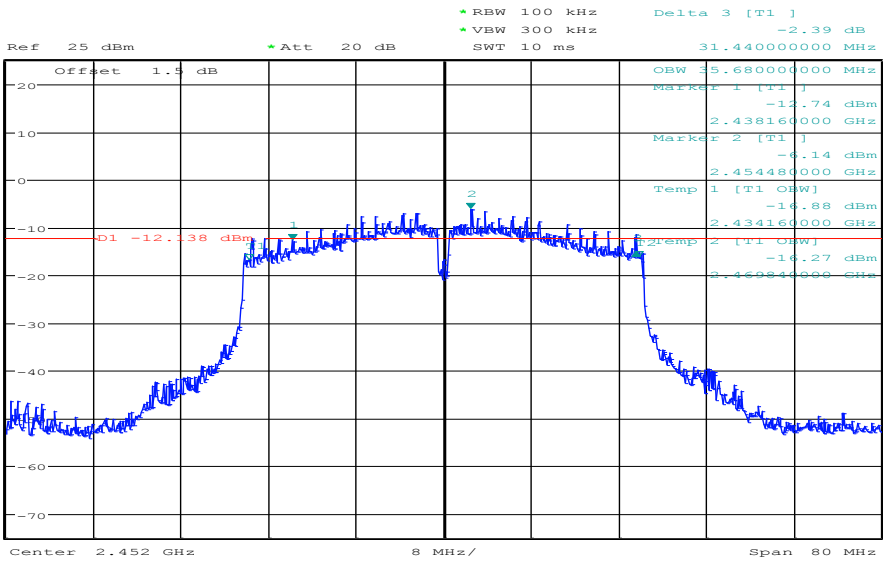

Date: 19.NOV.2018 13:20:57

## 5. Conducted peak Output Power

### 5.1. Block diagram of test setup

Same as section 4.1

### 5.2. Limits

For systems using digital modulation in the 902-928 MHz, 2400-2483.5 MHz, and 5725-5850 MHz bands: 1 Watt. If transmitting antennas of directional gain greater than 6 dBi are used, the conducted output power from the intentional radiator shall be reduced below the stated values as appropriate, by the amount in dB that the directional gain of the antenna exceeds 6 dBi.

### 5.3. Test Procedure

Connect each EUT's antenna output to power sensor by RF cable and attenuator  
Measure the PK output power of each antenna port by Spectrum Analyzer.

### 5.4. Test Result

| Test Mode | Antenna | Channel [MHz] | Result [dBm] | Limit [dBm] | Verdict |
|-----------|---------|---------------|--------------|-------------|---------|
| 11B       | ANT1    | 2412          | 16.44        | 30          | PASS    |
| 11B       | ANT1    | 2437          | 16.38        | 30          | PASS    |
| 11B       | ANT1    | 2462          | 16.50        | 30          | PASS    |
| 11G       | ANT1    | 2412          | 16.32        | 30          | PASS    |
| 11G       | ANT1    | 2437          | 16.41        | 30          | PASS    |
| 11G       | ANT1    | 2462          | 16.52        | 30          | PASS    |
| 11N20MIMO | ANT1    | 2412          | 8.07         | 30          | PASS    |
| 11N20MIMO | ANT2    | 2412          | 15.14        | 30          | PASS    |
| 11N20MIMO | total   | 2412          | 15.89        | 30          | PASS    |
| 11N20MIMO | ANT1    | 2437          | 7.23         | 30          | PASS    |
| 11N20MIMO | ANT2    | 2437          | 14.87        | 30          | PASS    |
| 11N20MIMO | total   | 2437          | 15.58        | 30          | PASS    |
| 11N20MIMO | ANT1    | 2462          | 7.15         | 30          | PASS    |
| 11N20MIMO | ANT2    | 2462          | 15.02        | 30          | PASS    |
| 11N20MIMO | total   | 2462          | 15.67        | 30          | PASS    |
| 11N40MIMO | ANT1    | 2422          | 7.61         | 30          | PASS    |
| 11N40MIMO | ANT2    | 2422          | 15.02        | 30          | PASS    |
| 11N40MIMO | total   | 2422          | 15.73        | 30          | PASS    |
| 11N40MIMO | ANT1    | 2437          | 7.31         | 30          | PASS    |
| 11N40MIMO | ANT2    | 2437          | 15.05        | 30          | PASS    |
| 11N40MIMO | total   | 2437          | 15.77        | 30          | PASS    |
| 11N40MIMO | ANT1    | 2452          | 7.51         | 30          | PASS    |
| 11N40MIMO | ANT2    | 2452          | 15.24        | 30          | PASS    |
| 11N40MIMO | total   | 2452          | 15.88        | 30          | PASS    |

### 5.5. original test data

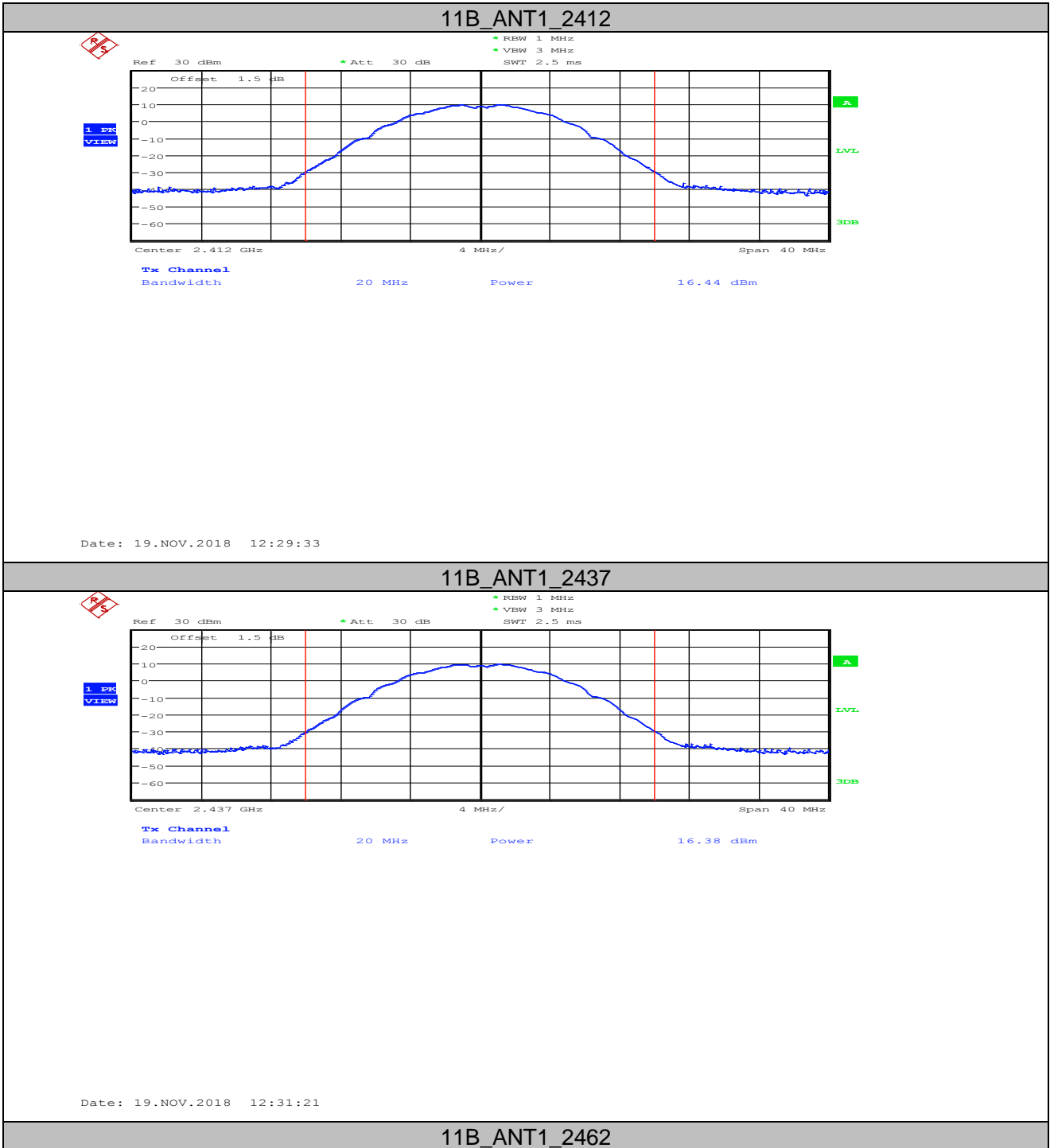



1. Fx  
VIEW

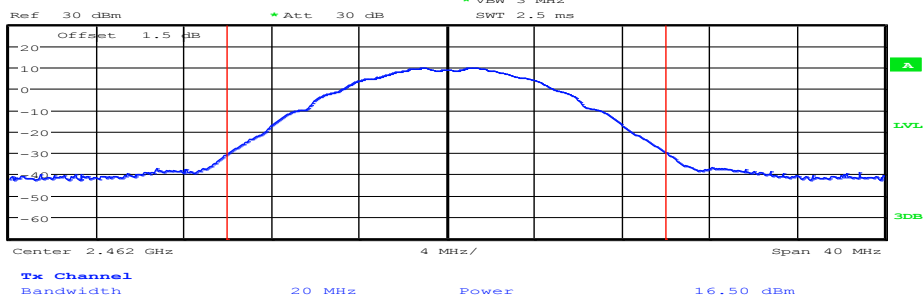

Date: 19.NOV.2018 12:32:41

11G\_ANT1\_2412



1. Fx  
VIEW

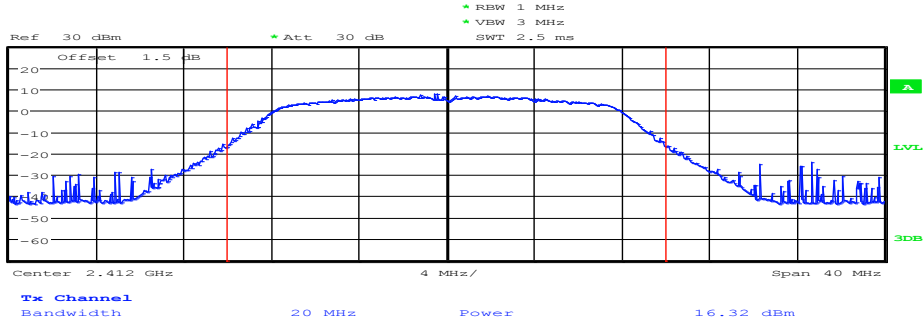

Date: 19.NOV.2018 12:36:44

11G\_ANT1\_2437



1. Fx  
VIEW

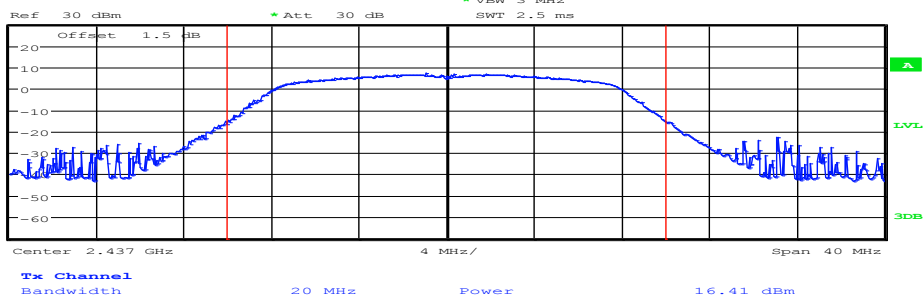

Date: 19.NOV.2018 12:38:21

11G\_ANT1\_2462



1. Fx  
VIEW

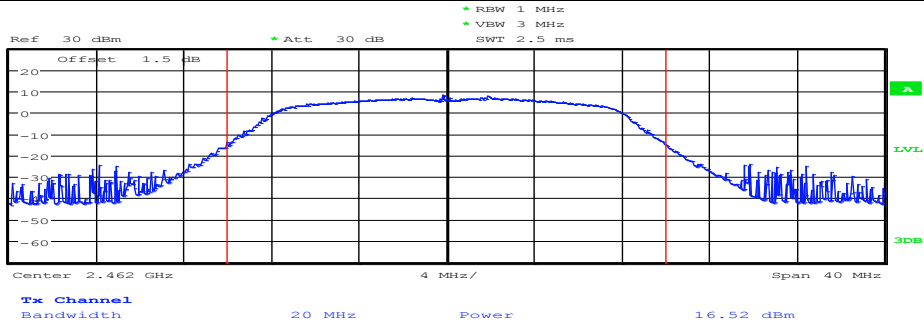

Date: 19.NOV.2018 12:39:45

11N20MIMO\_ANT1\_2412





1. Fx  
VIEW

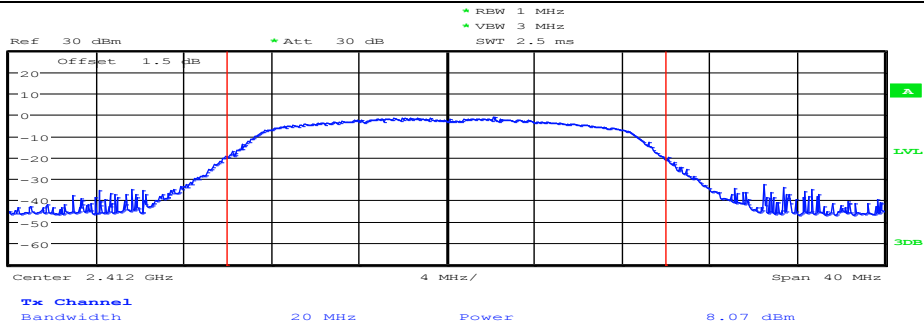

Date: 19.NOV.2018 12:54:51

11N20MIMO\_ANT2\_2412



1. Fx  
VIEW

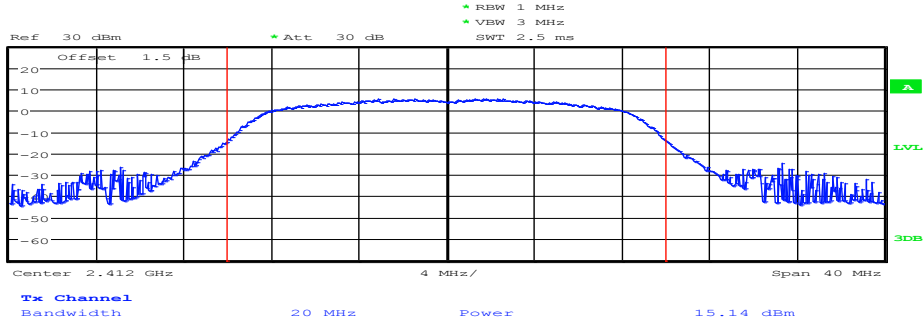

Date: 19.NOV.2018 13:01:04

11N20MIMO\_ANT1\_2437



1. Fx  
VIEW

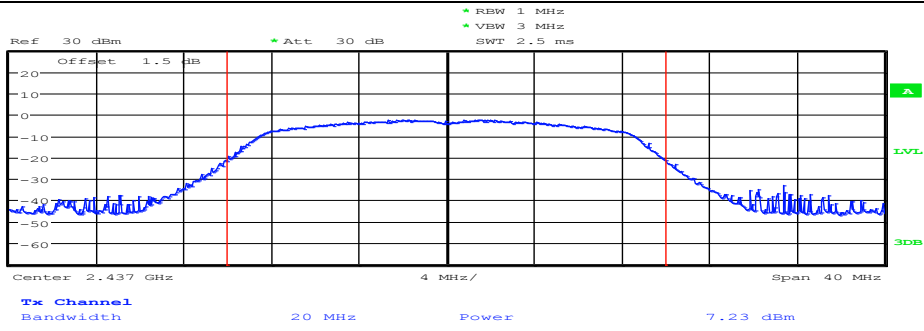

Date: 19.NOV.2018 12:56:27

11N20MIMO\_ANT2\_2437



1. Fx  
VIEW

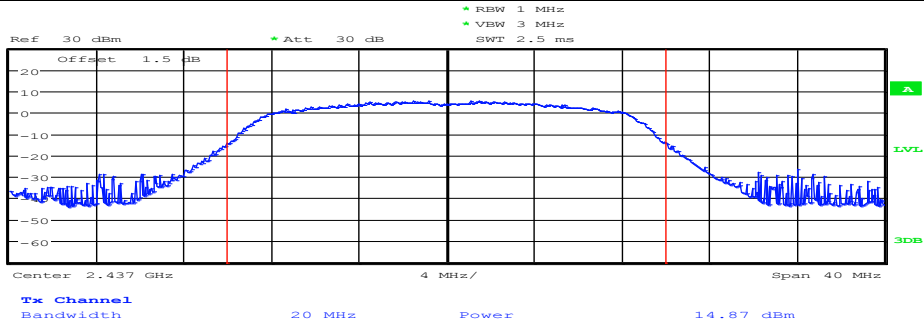

Date: 19.NOV.2018 13:02:35

11N20MIMO\_ANT1\_2462



1. Fx  
VIEW

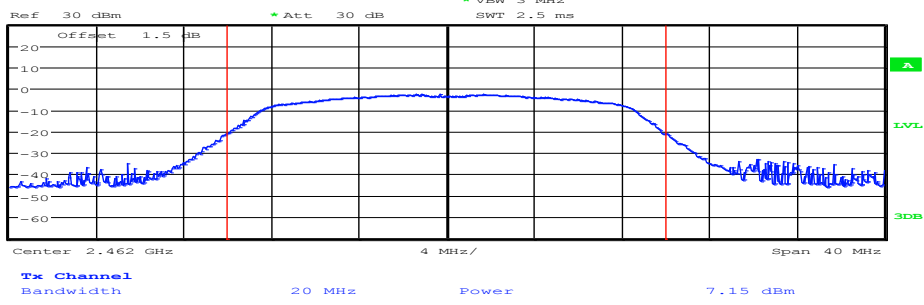

Date: 19.NOV.2018 12:58:31

11N20MIMO\_ANT2\_2462



1. Fx  
VIEW

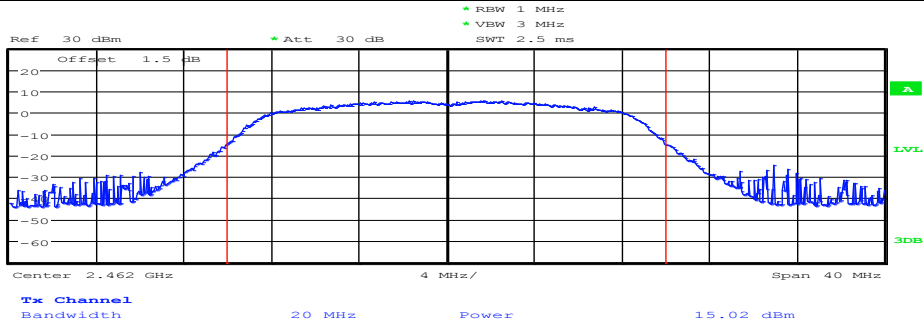

Date: 19.NOV.2018 13:04:53

11N40MIMO\_ANT1\_2422



1. Fx  
VIEW

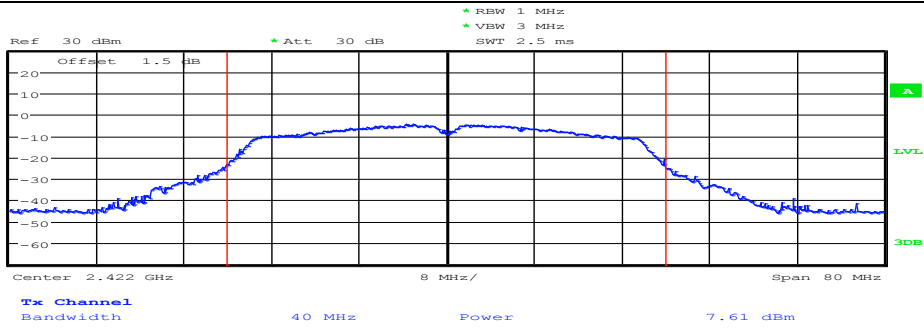

Date: 19.NOV.2018 13:10:11

11N40MIMO\_ANT2\_2422



1. Fx  
VIEW

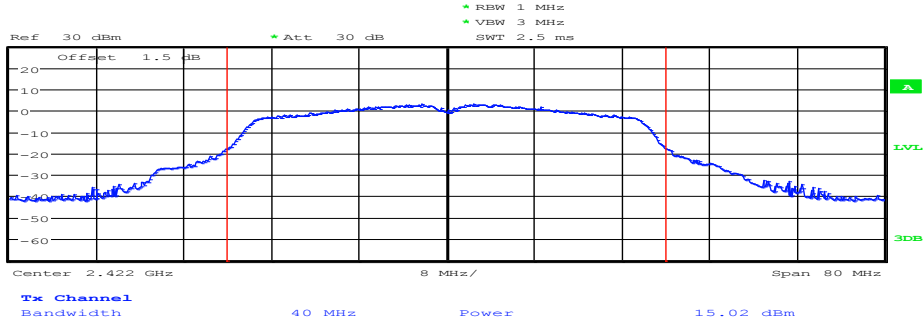

Date: 19.NOV.2018 13:17:52

11N40MIMO\_ANT1\_2437

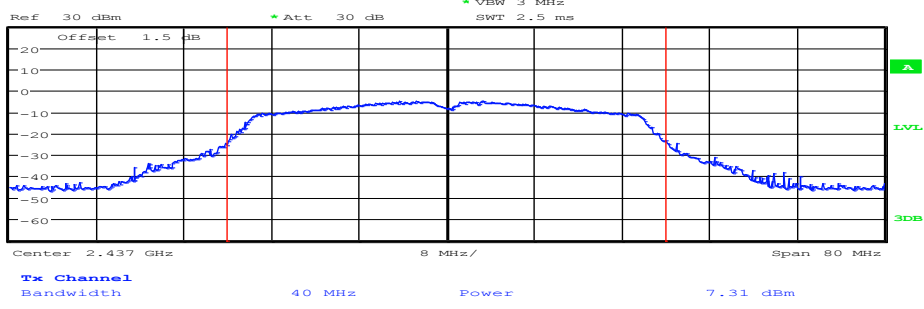

Date: 19.NOV.2018 13:12:41

11N40MIMO\_ANT2\_2437

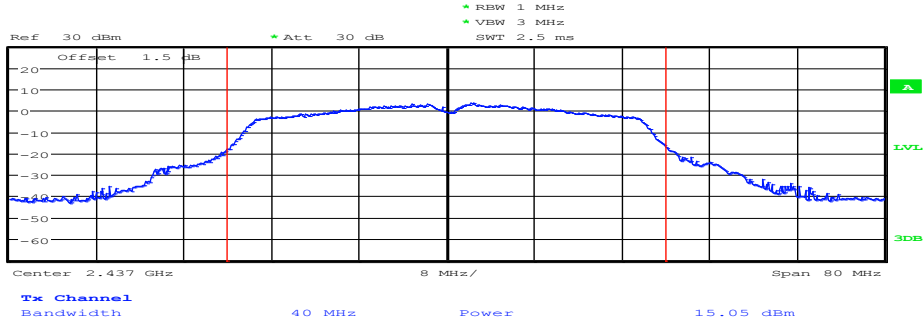

Date: 19.NOV.2018 13:19:38

11N40MIMO\_ANT1\_2452

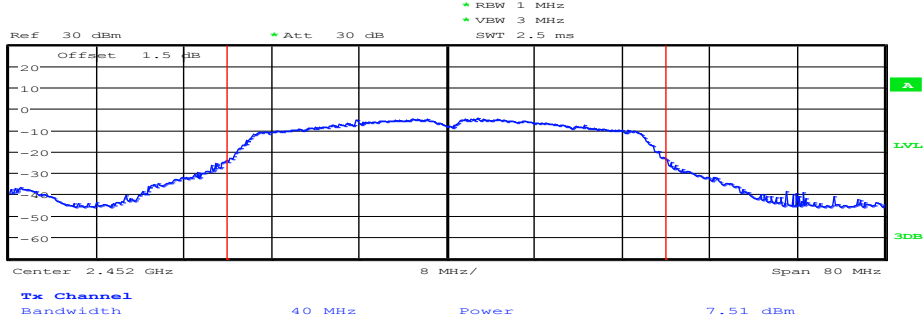

Date: 19.NOV.2018 13:14:57

11N40MIMO\_ANT2\_2452

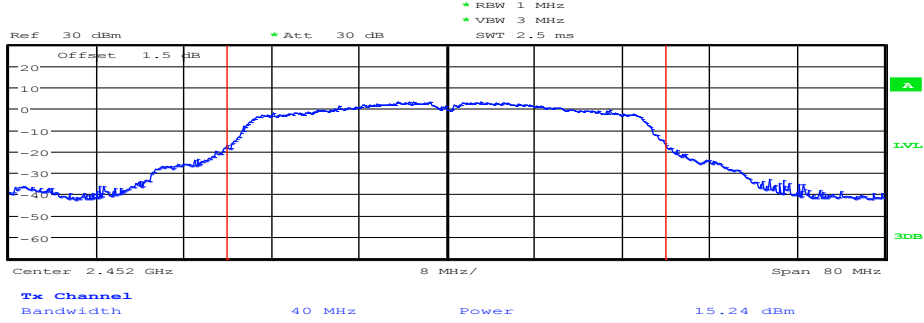

Date: 19.NOV.2018 13:21:10

## 6. Power Spectral Density

### 6.1. Block diagram of test setup

Same as section 4.1

### 6.2. Limits

For digitally modulated systems, the power spectral density conducted from the intentional radiator to the antenna shall not be greater than 8dBm in any 3 kHz band during any time interval of continuous transmission.

### 6.3. Test Procedure

(1) Connect EUT's antenna output to spectrum analyzer by RF cable.

(2) Set the spectrum analyzer as follows:

|                  |  |
|------------------|--|
| Center frequency | DTS Channel center frequency                         |
| RBW:             | $3 \text{ kHz} \leq \text{RBW} \leq 100 \text{ kHz}$ |
| VBW:             | $\geq 3\text{RBW}$                                   |
| Span             | 1.5 times the DTS bandwidth                          |
| Detector Mode:   | RMS  |
| Sweep time:      | auto   |
| Trace mode       | Max hold   |

(3) Allow the trace to stabilize, use the peak marker function to determine the maximum amplitude level within the RBW.

(4) If measured value exceeds limit, reduce RBW (no less than 3 kHz) and repeat.

### 6.4. Test Result

| Test Mode | Antenna | Channel [MHz] | PSD [dBm/3kHz] | Limit[dBm/3kHz] | Verdict |
|-----------|---------|---------------|----------------|-----------------|---------|
| 11B       | ANT1    | 2412          | -9.64          | 8               | PASS    |
| 11B       | ANT1    | 2437          | -9.87          | 8               | PASS    |
| 11B       | ANT1    | 2462          | -9.47          | 8               | PASS    |
| 11G       | ANT1    | 2412          | -16.16         | 8               | PASS    |
| 11G       | ANT1    | 2437          | -17.11         | 8               | PASS    |
| 11G       | ANT1    | 2462          | -17.30         | 8               | PASS    |
| 11N20MIMO | ANT1    | 2412          | -23.27         | 8               | PASS    |
| 11N20MIMO | ANT2    | 2412          | -19.85         | 8               | PASS    |
| 11N20MIMO | total   | 2412          | -18.22         | 8               | PASS    |
| 11N20MIMO | ANT1    | 2437          | -27.30         | 8               | PASS    |
| 11N20MIMO | ANT2    | 2437          | -19.73         | 8               | PASS    |
| 11N20MIMO | total   | 2437          | -19.03         | 8               | PASS    |
| 11N20MIMO | ANT1    | 2462          | -25.34         | 8               | PASS    |
| 11N20MIMO | ANT2    | 2462          | -19.62         | 8               | PASS    |
| 11N20MIMO | total   | 2462          | -18.59         | 8               | PASS    |
| 11N40MIMO | ANT1    | 2422          | -28.02         | 8               | PASS    |
| 11N40MIMO | ANT2    | 2422          | -21.42         | 8               | PASS    |
| 11N40MIMO | total   | 2422          | -20.56         | 8               | PASS    |

|           |       |      |        |   |      |
|-----------|-------|------|--------|---|------|
| 11N40MIMO | ANT1  | 2437 | -28.82 | 8 | PASS |
| 11N40MIMO | ANT2  | 2437 | -20.79 | 8 | PASS |
| 11N40MIMO | total | 2437 | -20.16 | 8 | PASS |
| 11N40MIMO | ANT1  | 2452 | -27.83 | 8 | PASS |
| 11N40MIMO | ANT2  | 2452 | -21.95 | 8 | PASS |
| 11N40MIMO | total | 2452 | -20.95 | 8 | PASS |

6.5. original test data

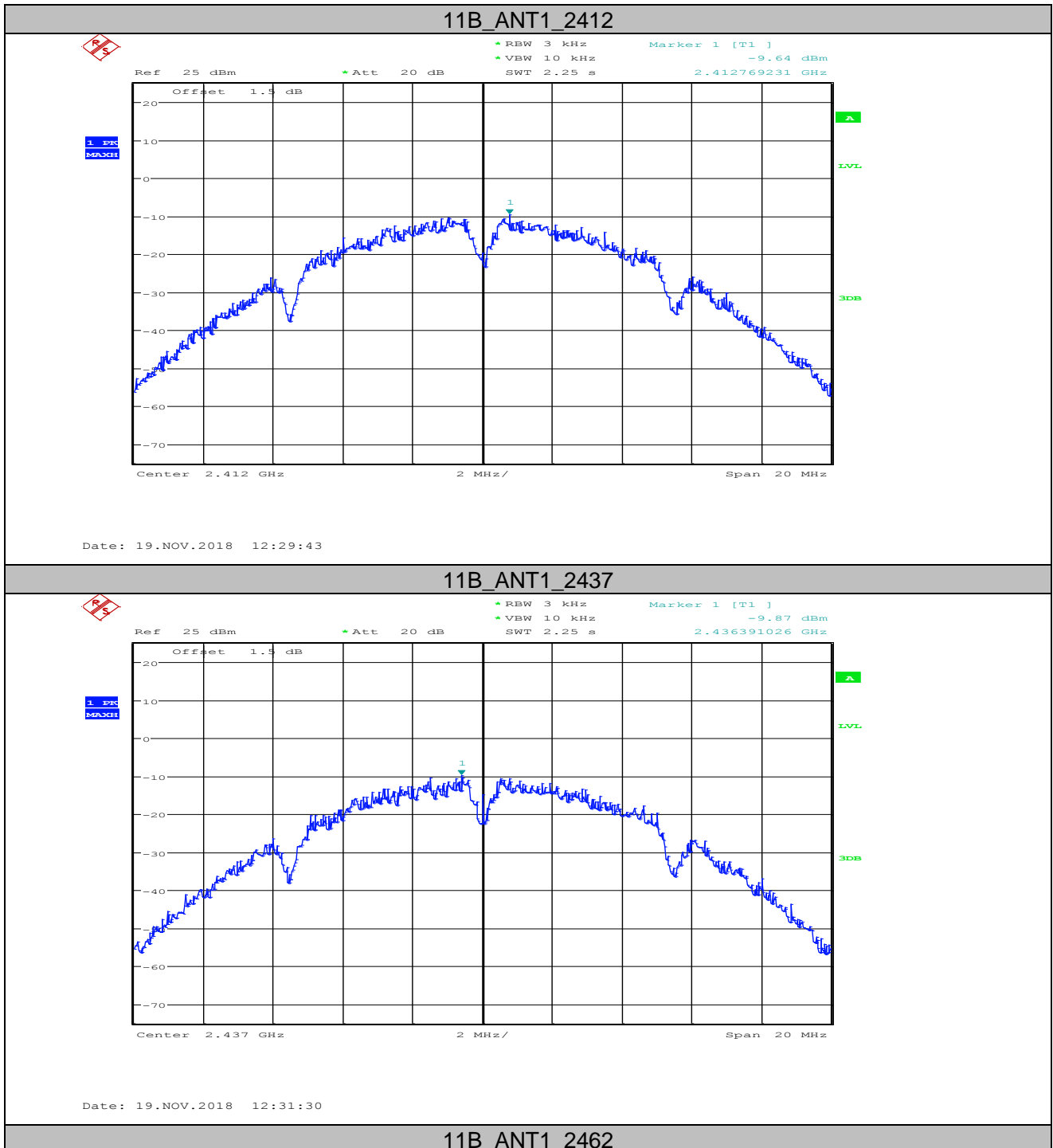



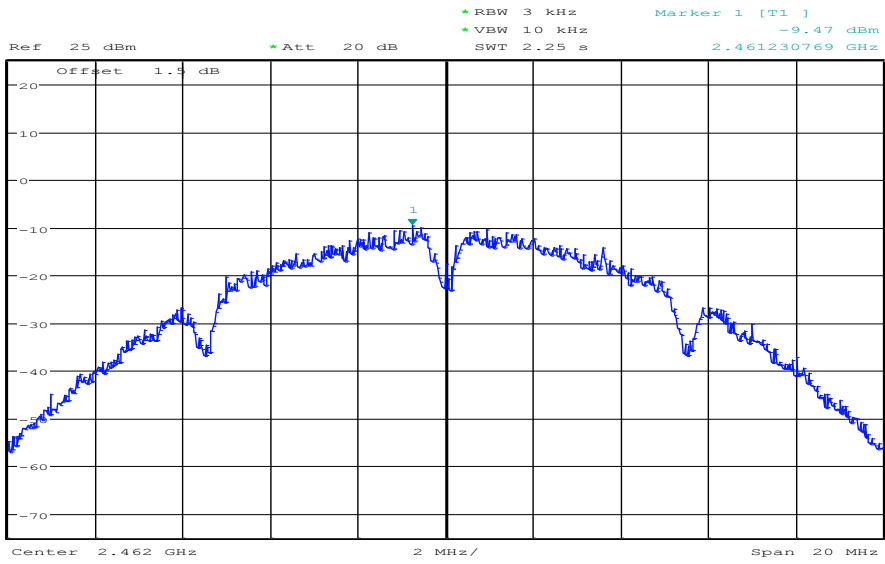

Date: 19.NOV.2018 12:32:51

11G\_ANT1\_2412

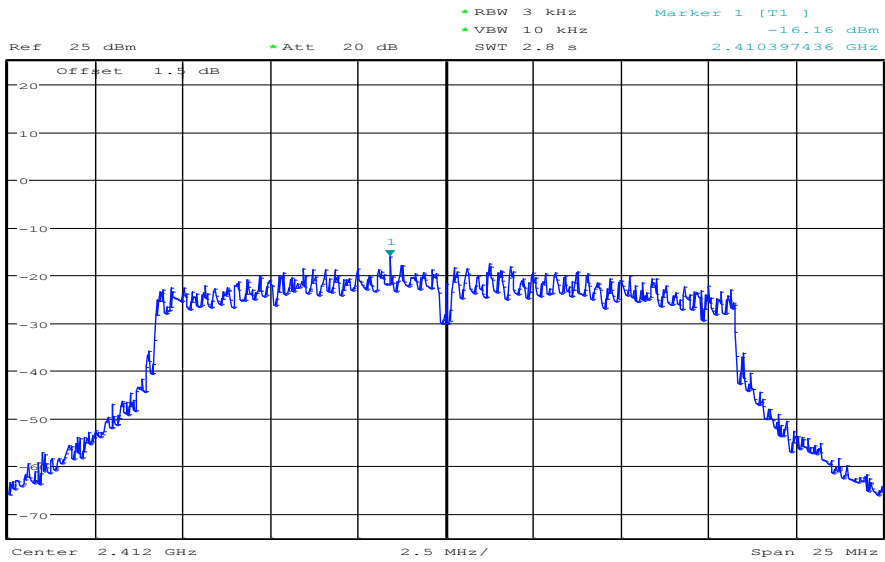

Date: 19.NOV.2018 12:36:54

11G\_ANT1\_2437

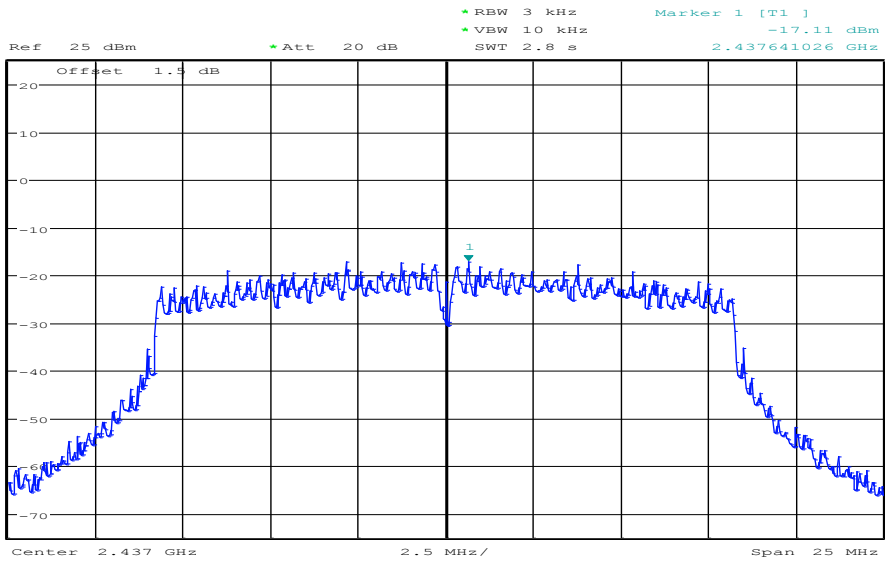

Date: 19.NOV.2018 12:38:30

11G\_ANT1\_2462

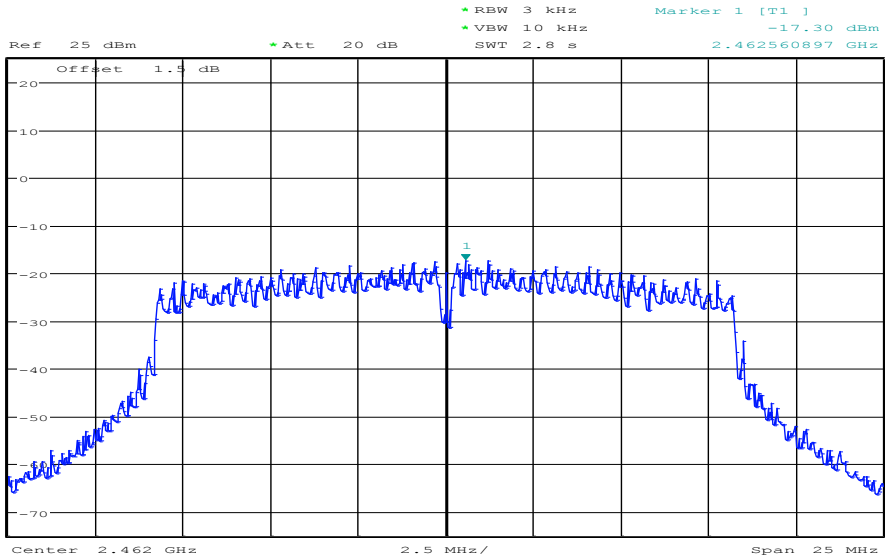

Date: 19.NOV.2018 12:39:54

11N20MIMO\_ANT1\_2412

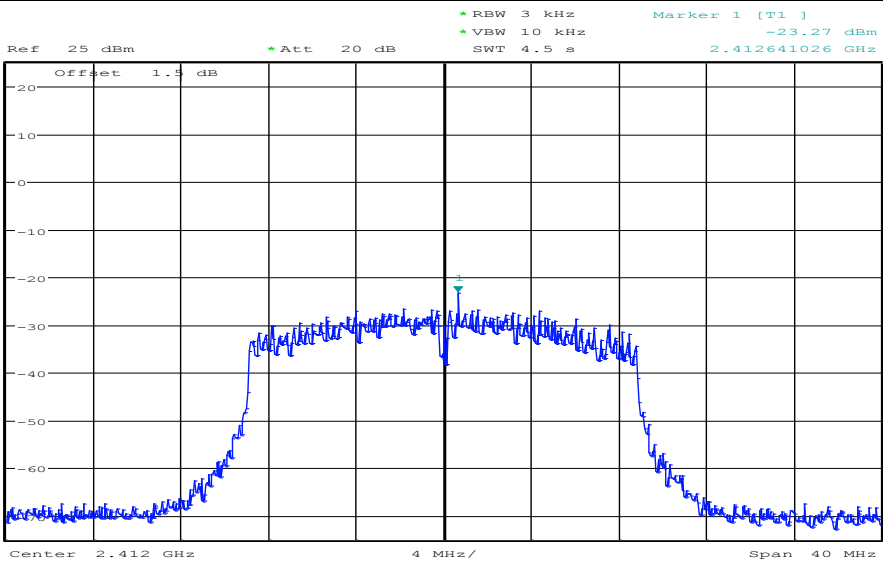

Date: 19.NOV.2018 12:55:01

11N20MIMO\_ANT2\_2412

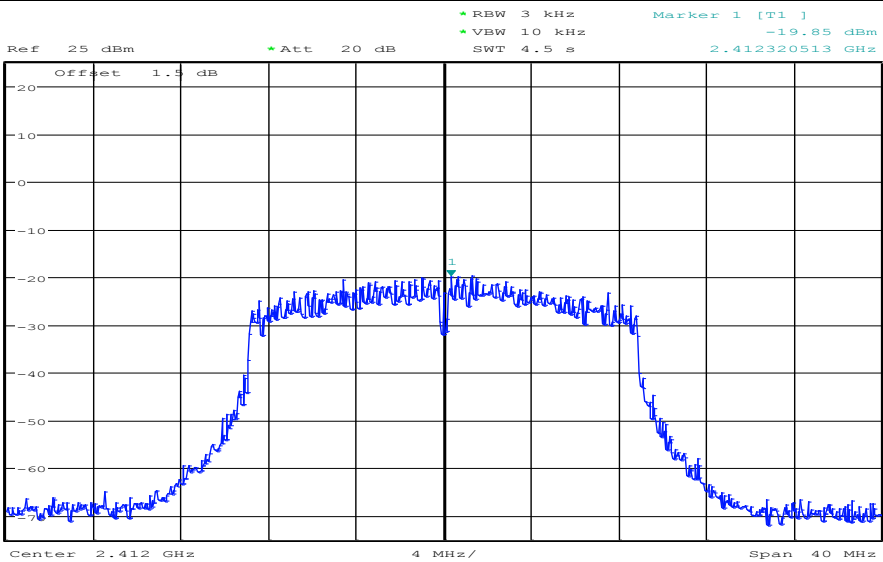

Date: 19.NOV.2018 13:01:14

11N20MIMO\_ANT1\_2437

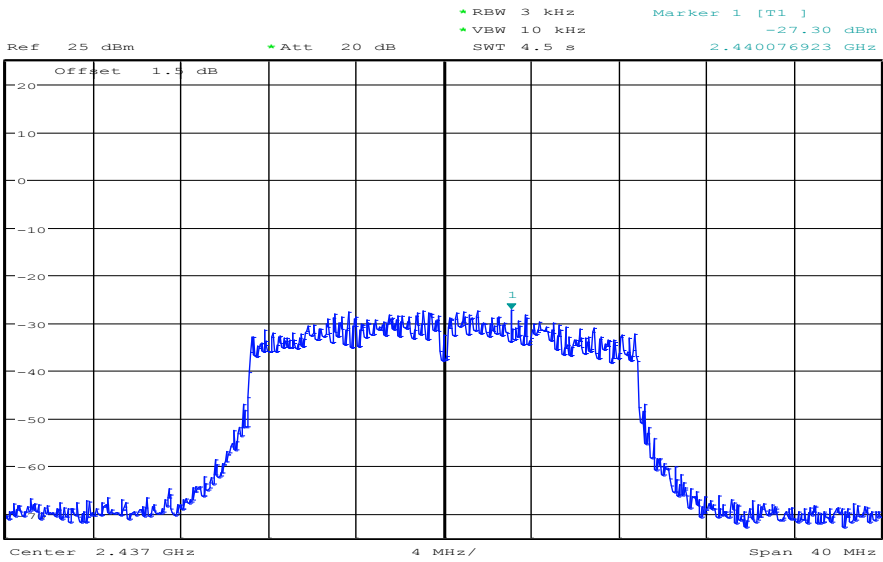

Date: 19.NOV.2018 12:56:37

11N20MIMO\_ANT2\_2437

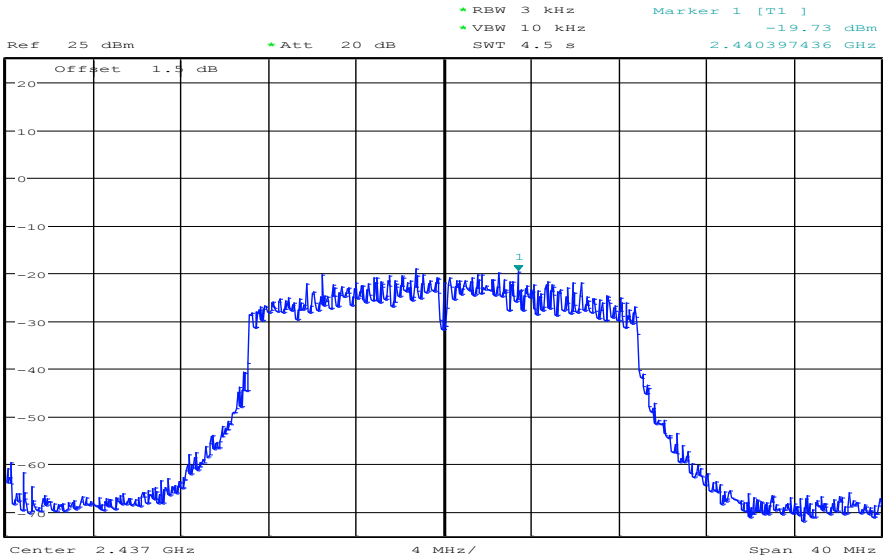

Date: 19.NOV.2018 13:03:42

11N20MIMO\_ANT1\_2462

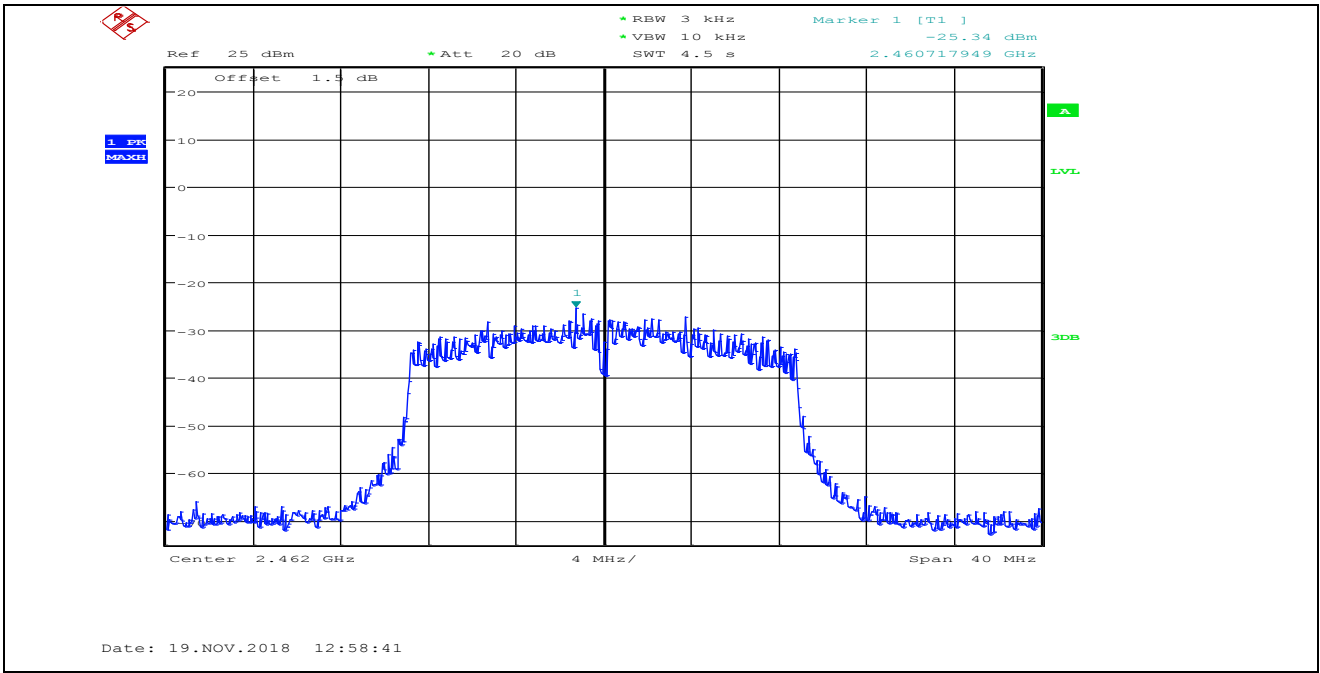

11N20MIMO\_ANT2\_2462

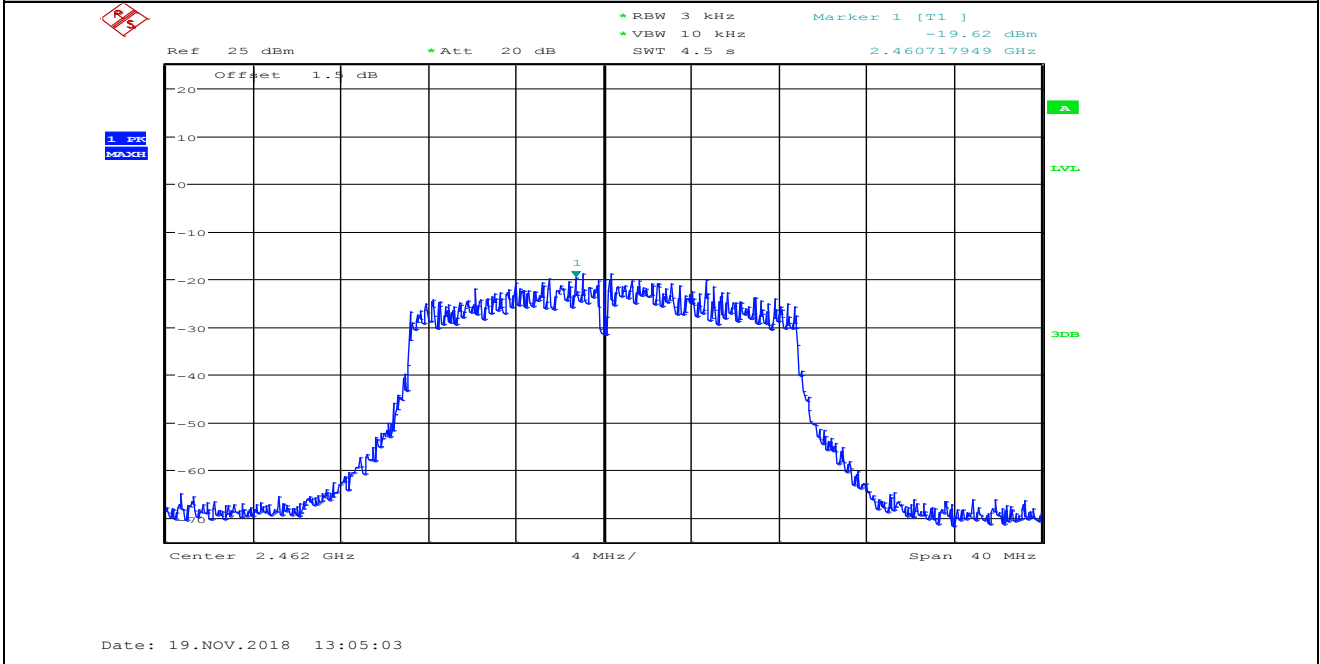

11N40MIMO\_ANT1\_2422

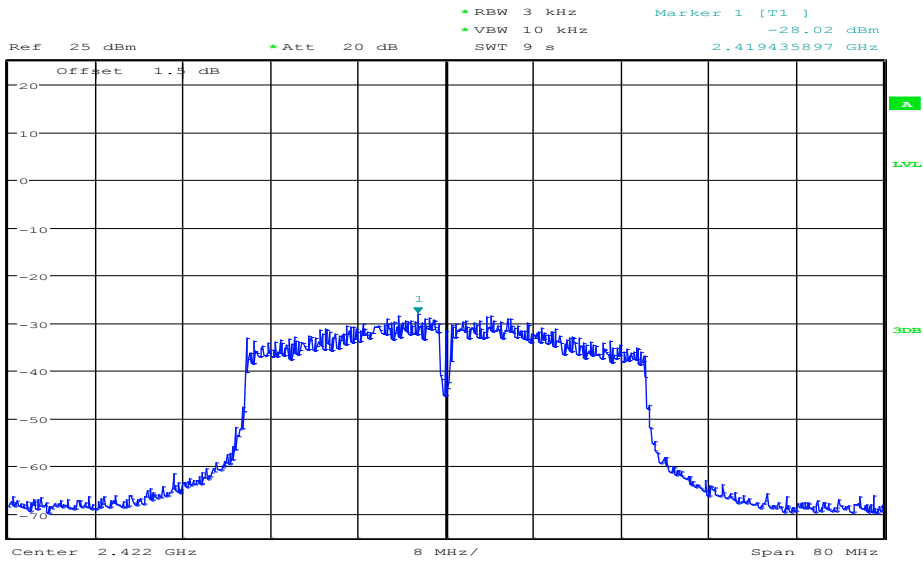

Date: 19.NOV.2018 13:10:57

11N40MIMO\_ANT2\_2422

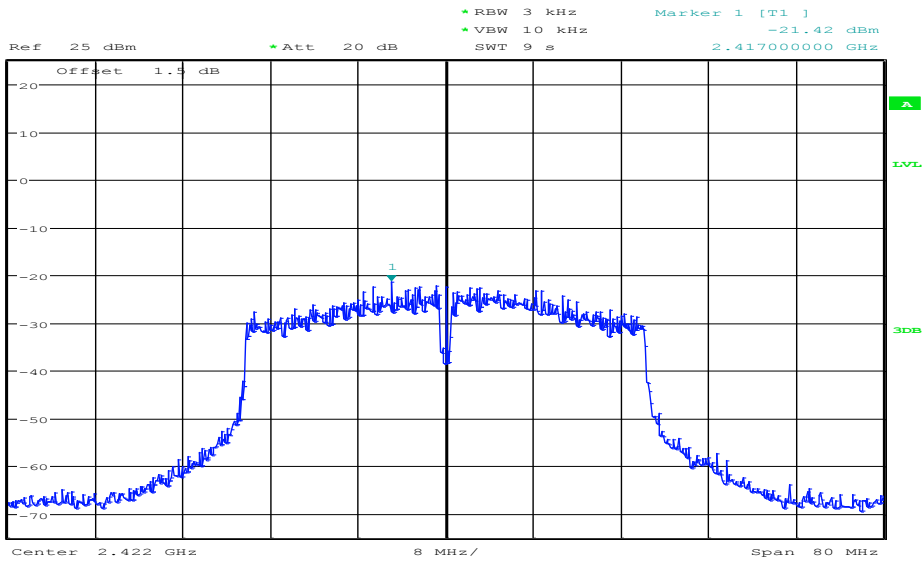

Date: 19.NOV.2018 13:18:14

11N40MIMO\_ANT1\_2437

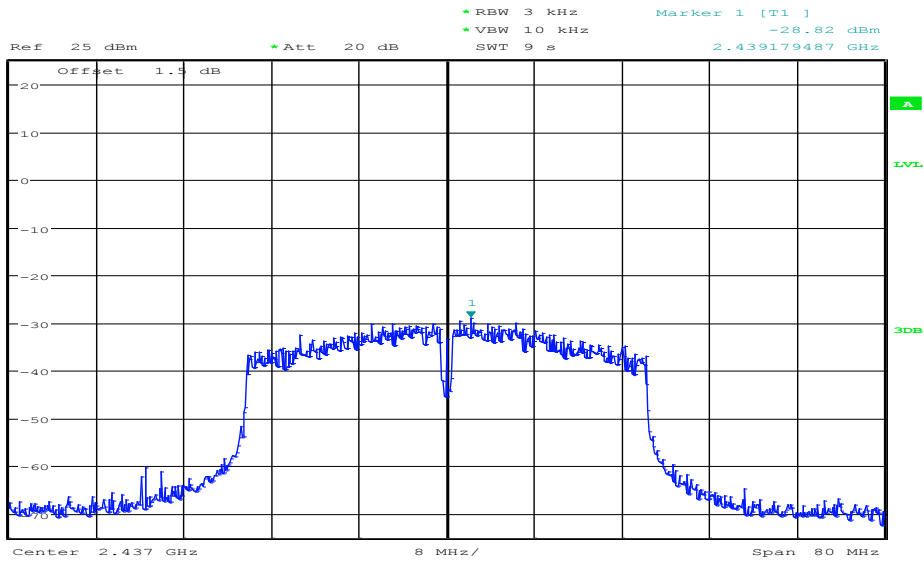

Date: 19.NOV.2018 13:12:58

11N40MIMO\_ANT2\_2437

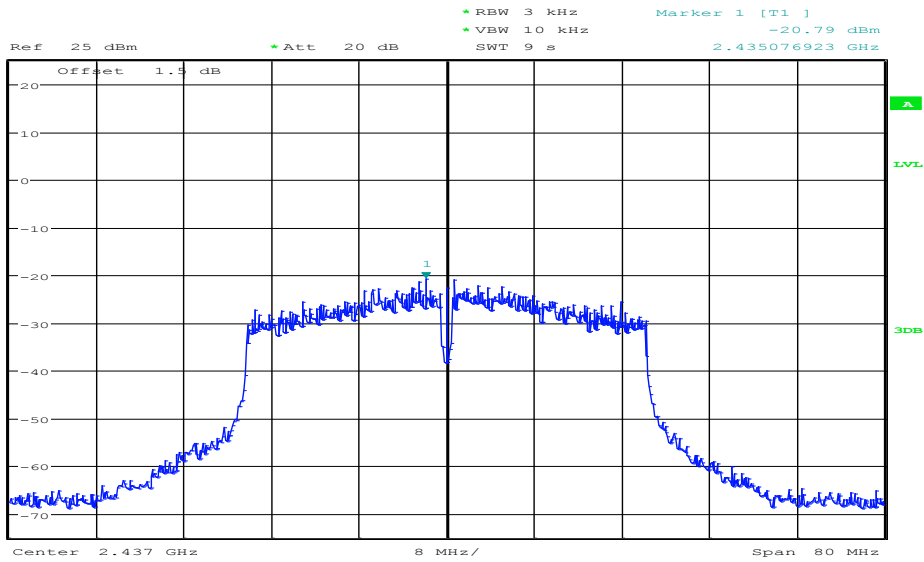

Date: 19.NOV.2018 13:20:02

11N40MIMO\_ANT1\_2452

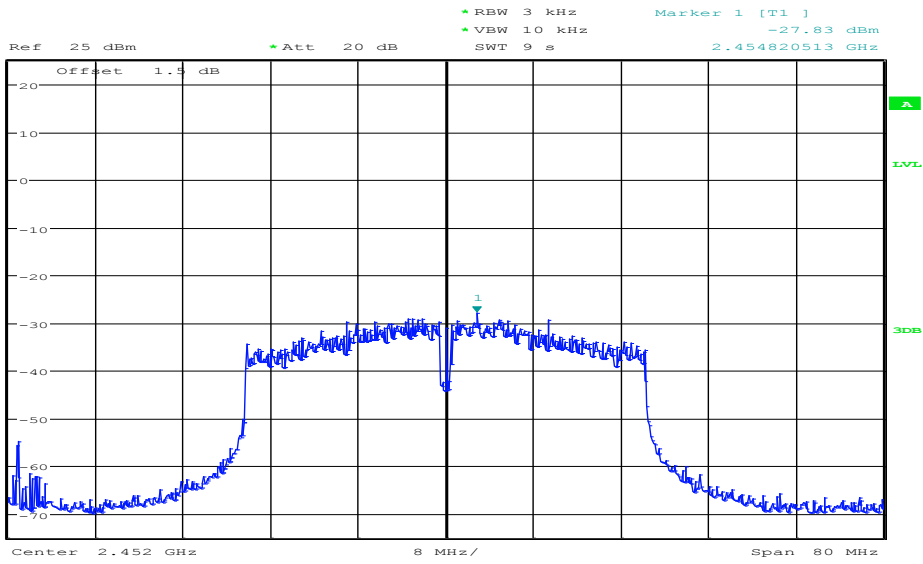

Date: 19.NOV.2018 13:15:34

11N40MIMO\_ANT2\_2452

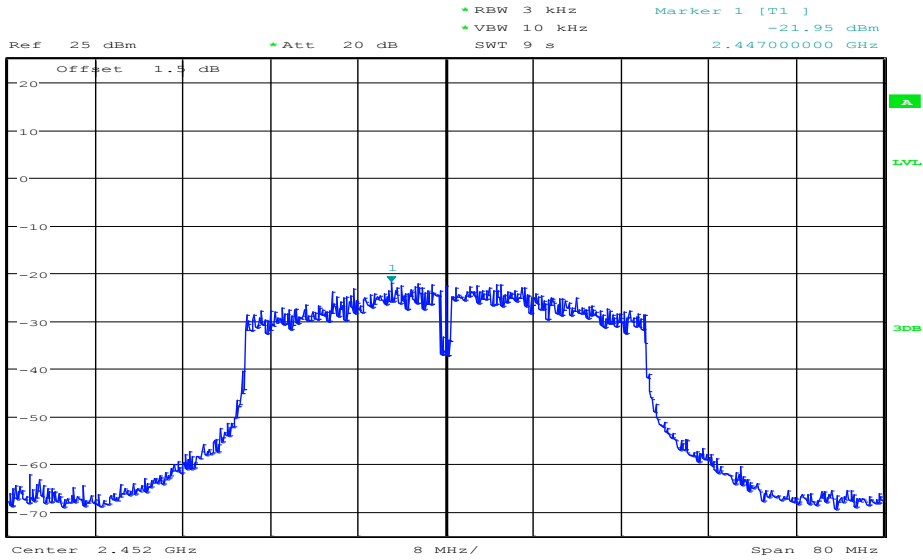

Date: 19.NOV.2018 13:21:32



## 7. Band Edge and Spurious Emissions (Conducted)

### 7.1. Block diagram of test setup

Same as section 4.1

### 7.2. Limits

In any 100kHz bandwidth outside the frequency bands in which the spread spectrum intentional radiator is operating, the radio frequency power that is produced by the intentional radiator shall be at least 30dB below that in the 100kHz bandwidth within the band that contains the highest level of the desired power.

### 7.3. Test Procedure

(1) Connect EUT's antenna output to spectrum analyzer by RF cable.

(2) Establish a reference level by using the following procedure:

|                  |                              |
|------------------|------------------------------|
| Center frequency | DTS Channel center frequency |
| RBW:             | 100kHz                       |
| VBW:             | 300kHz                       |
| Span             | 1.5times the DTS bandwidth   |
| Detector Mode:   | Peak                         |
| Sweep time:      | auto                         |
| Trace mode       | Max hold                     |

(3) Allow the trace to stabilize, use the peak marker function to determine the maximum peak power level to establish the reference level.

(4) Set the spectrum analyzer as follows:

|                              |  |
|------------------------------|--|
| RBW:                         | 100kHz                                   |
| VBW:                         | 300kHz                                   |
| Span                         | Encompass frequency range to be measured |
| Number of measurement points | $\geq \text{span}/\text{RBW}$            |
| Detector Mode:               | Peak                                     |
| Sweep time:                  | auto                                     |
| Trace mode                   | Max hold                                 |

(5) Allow the trace to stabilize, use the peak marker function to determine the maximum amplitude of all unwanted emissions outside of the authorized frequency band

7.4. Test Result

| EUT Set Mode | CH or Frequency | Ant1 Result (dBm) | EUT Set Mode | CH or Frequency | Ant1 Result (dBm) |
|--------------|-----------------|-------------------|--------------|-----------------|-------------------|
| 11b          | CH1             | PASS              | 11n HT 20    | CH1             | PASS              |
|              | CH6             | PASS              |              | CH6             | PASS              |
|              | CH11            | PASS              |              | CH11            | PASS              |
| 11g          | CH1             | PASS              | 11n HT 40    | CH3             | PASS              |
|              | CH6             | PASS              |              | CH6             | PASS              |
|              | CH11            | PASS              |              | CH9             | PASS              |

| EUT Set Mode | CH or Frequency | Ant2 Result (dBm) | EUT Set Mode | CH or Frequency | Ant2 Result (dBm) |
|--------------|-----------------|-------------------|--------------|-----------------|-------------------|
| 11n HT 20    | CH1             | PASS              | 11n HT 40    | CH3             | PASS              |
|              | CH6             | PASS              |              | CH6             | PASS              |
|              | CH11            | PASS              |              | CH9             | PASS              |

7.5. original test data

Band Edge

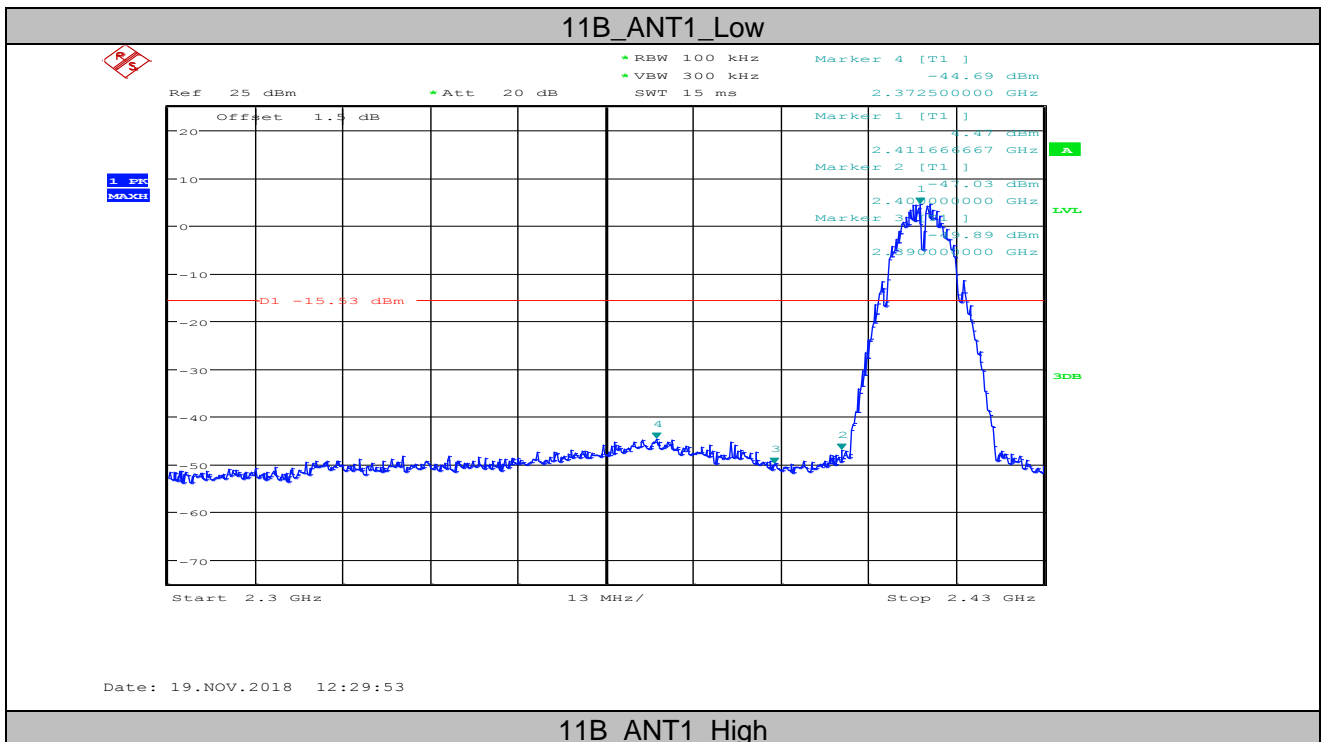

11B\_ANT1\_High

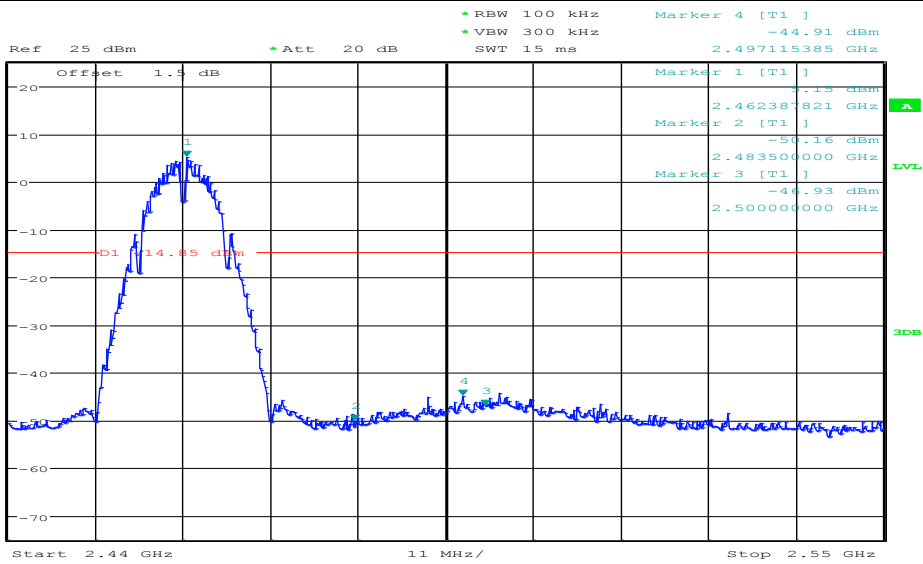

Date: 19.NOV.2018 12:33:01

11G\_ANT1\_Low

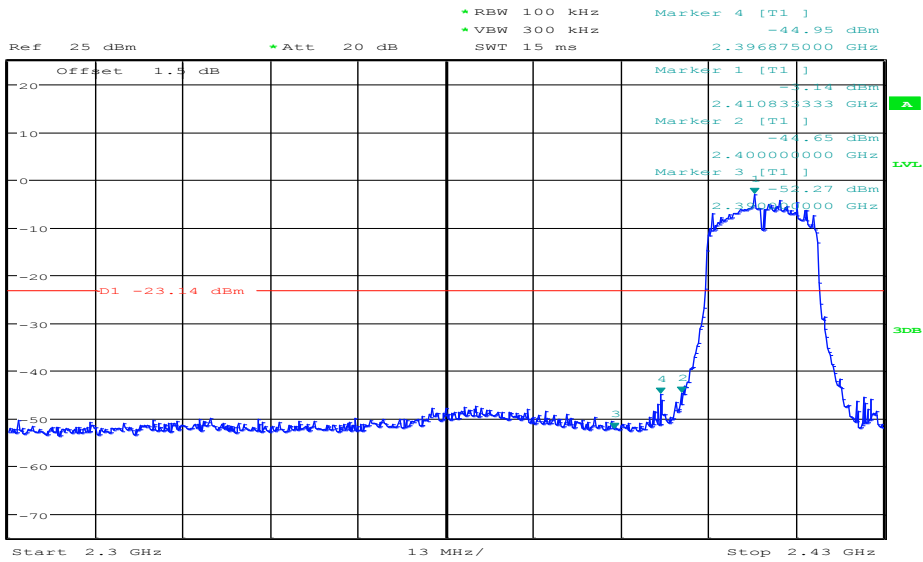

Date: 19.NOV.2018 12:37:04

11G\_ANT1\_High

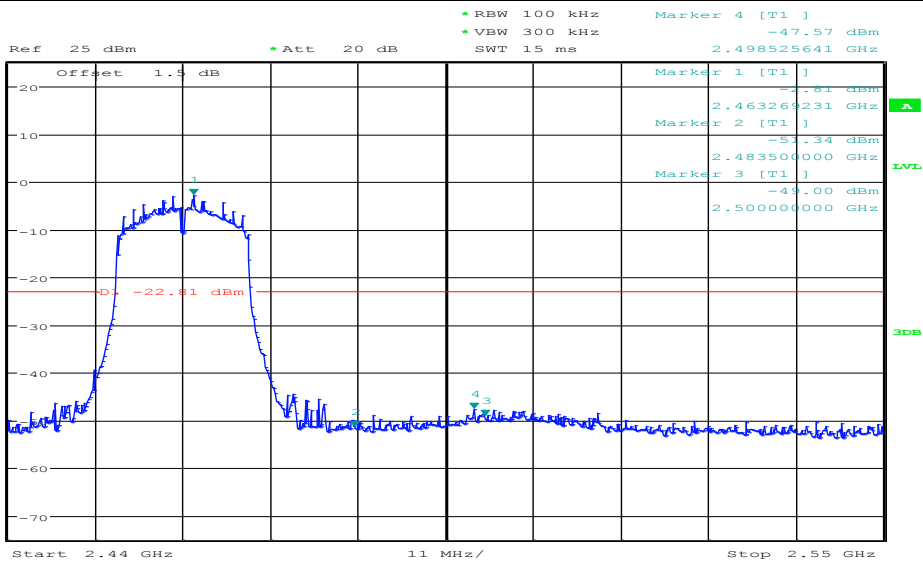

Date: 19.NOV.2018 12:40:04

11N20MIMO\_ANT1\_Low

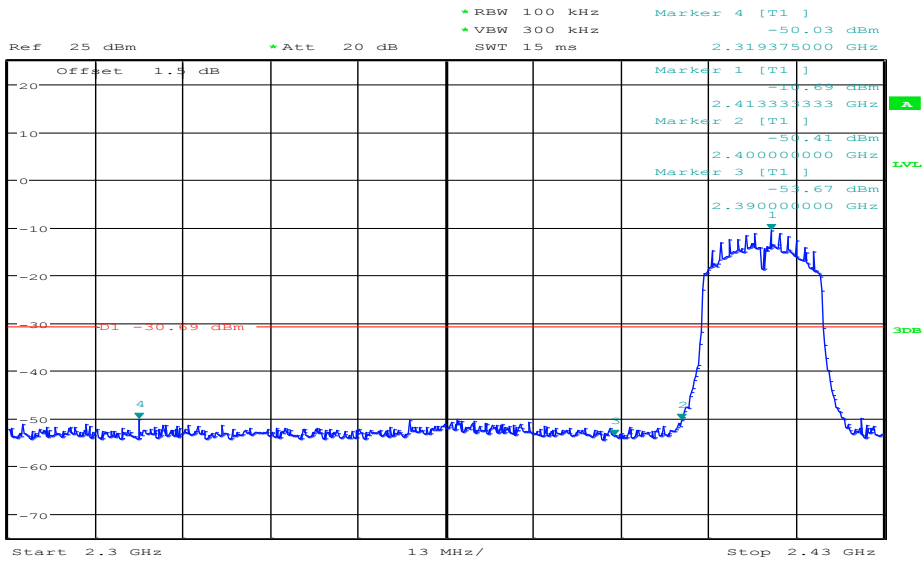

Date: 19.NOV.2018 12:55:11

11N20MIMO\_ANT2\_Low

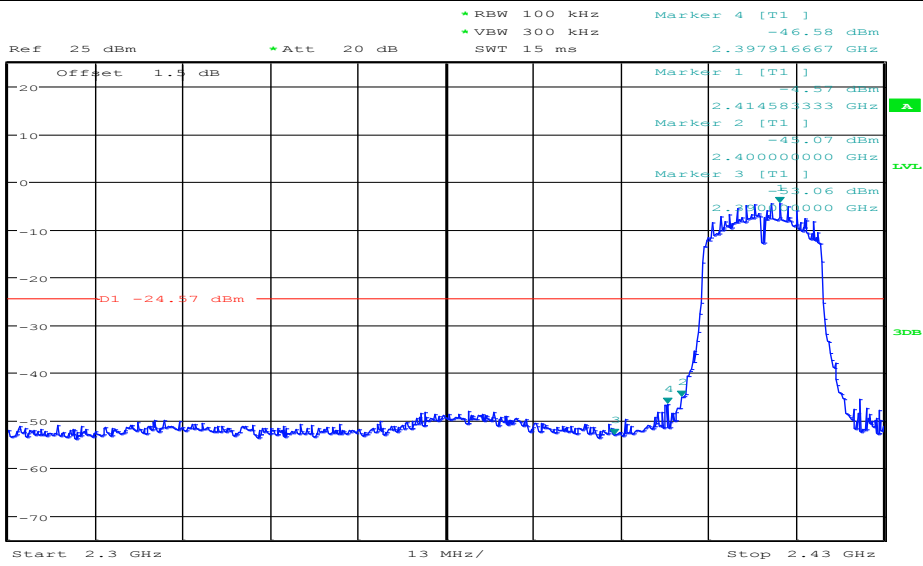

Date: 19.NOV.2018 13:01:25

11N20MIMO\_ANT1\_High

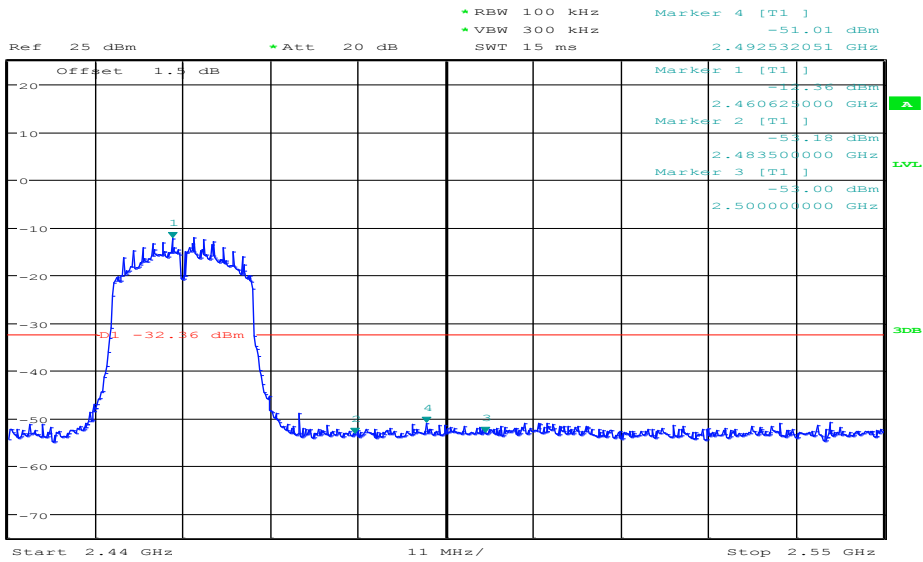

Date: 19.NOV.2018 12:58:51

11N20MIMO\_ANT2\_High

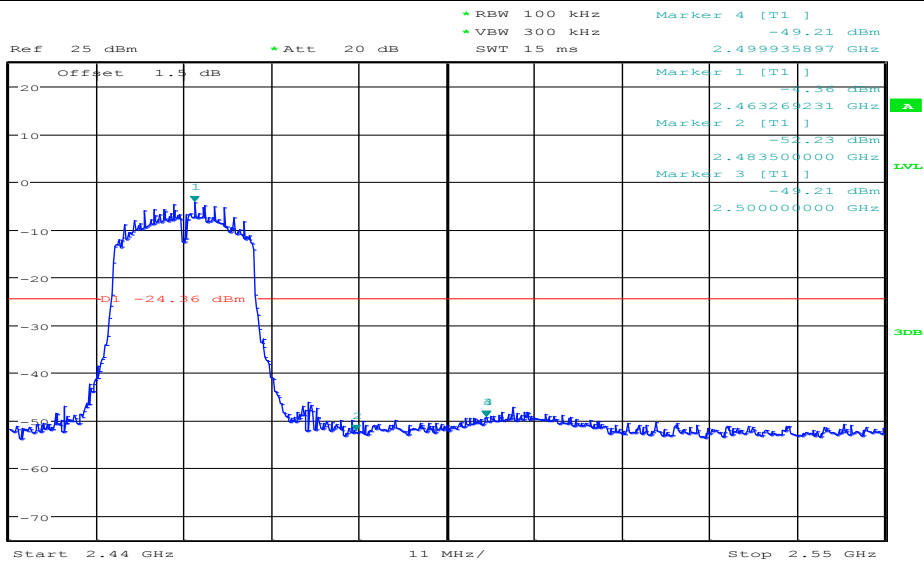

Date: 19.NOV.2018 13:05:14

11N40MIMO\_ANT1\_Low

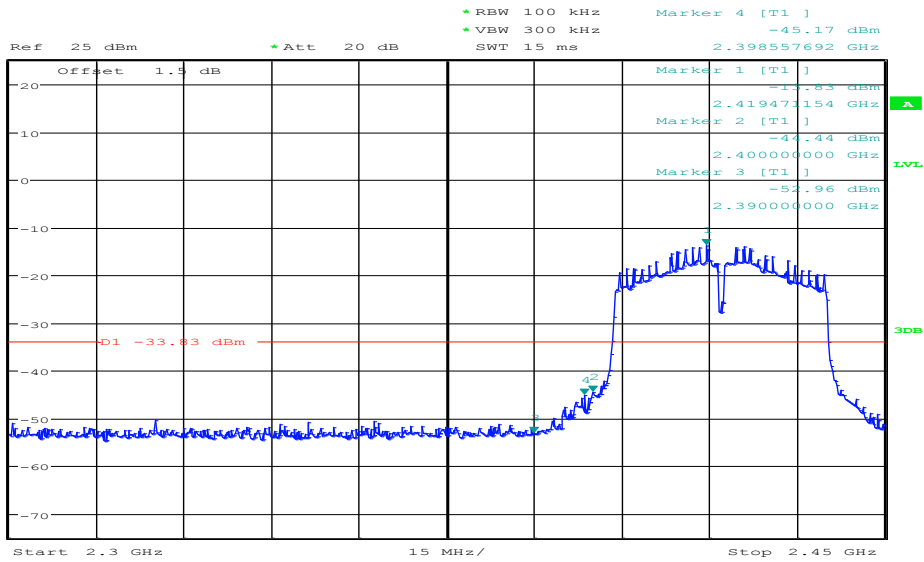

Date: 19.NOV.2018 13:11:07

11N40MIMO\_ANT2\_Low



1. Pk  
MAX

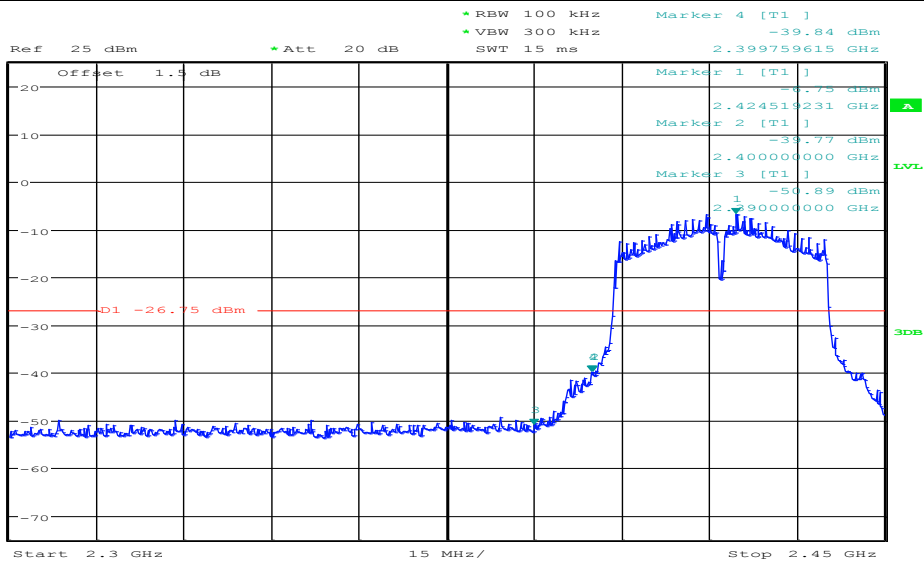

Date: 19.NOV.2018 13:18:24

11N40MIMO\_ANT1\_High



1. Pk  
MAX

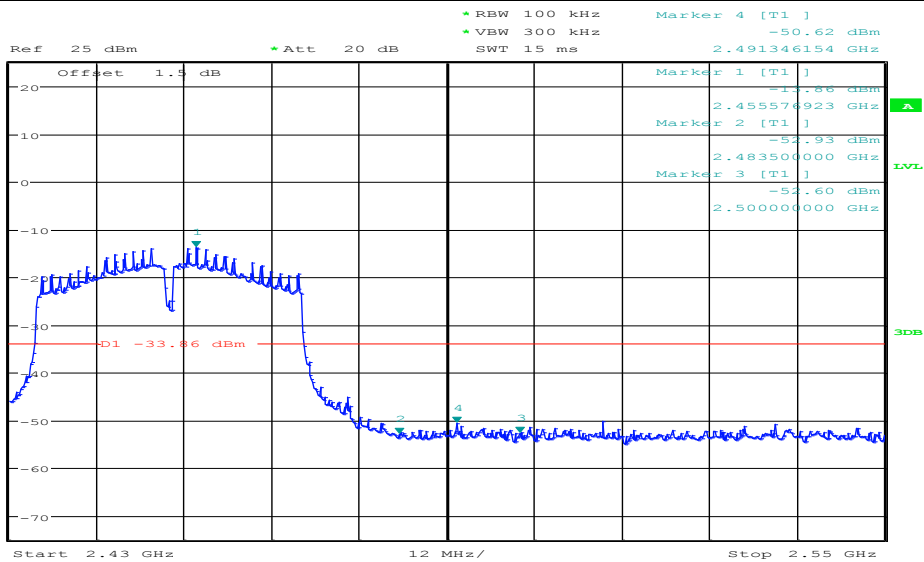

Date: 19.NOV.2018 13:15:44

11N40MIMO\_ANT2\_High

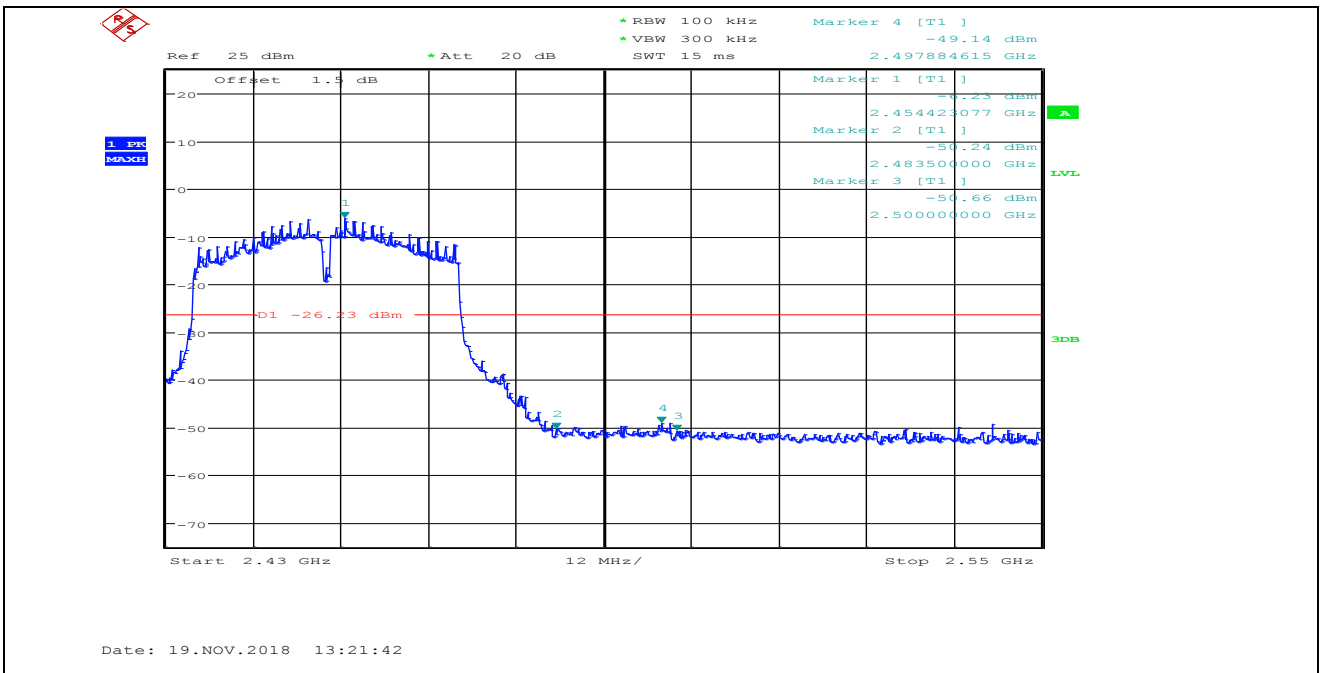

Spurious Emissions

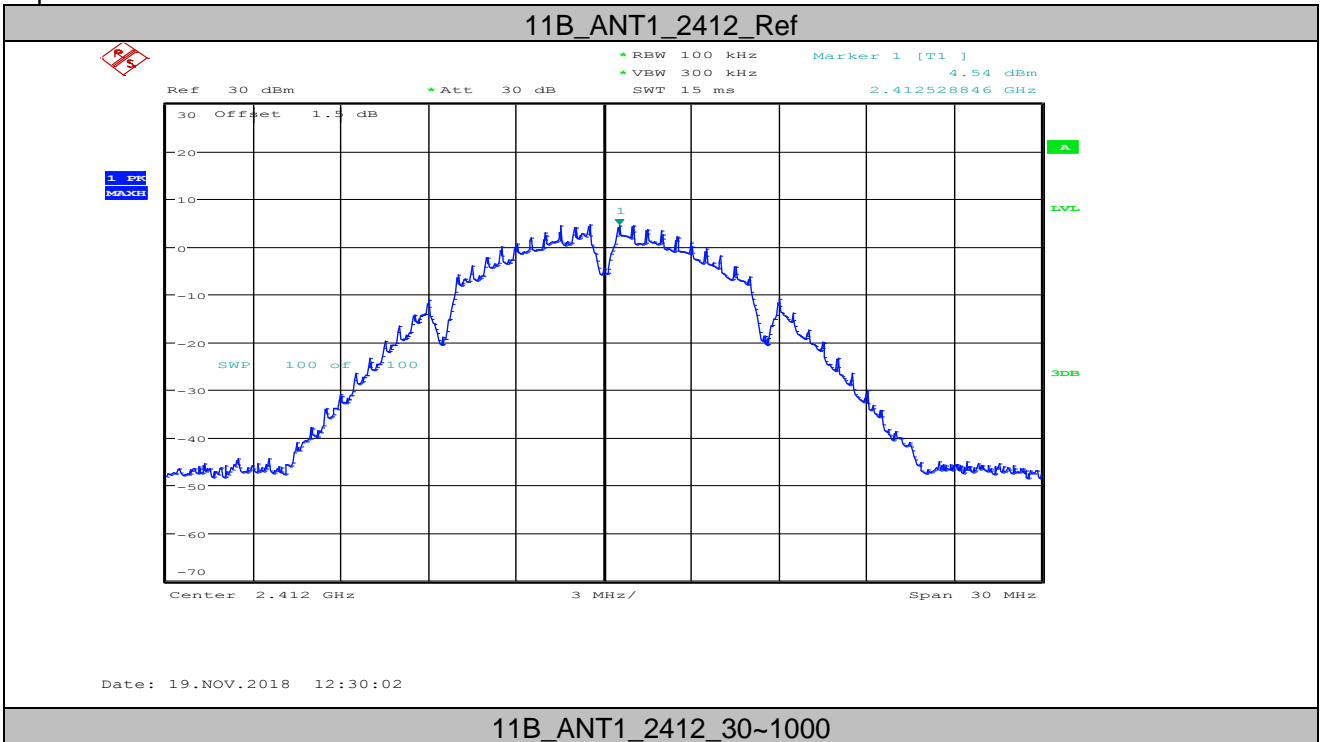



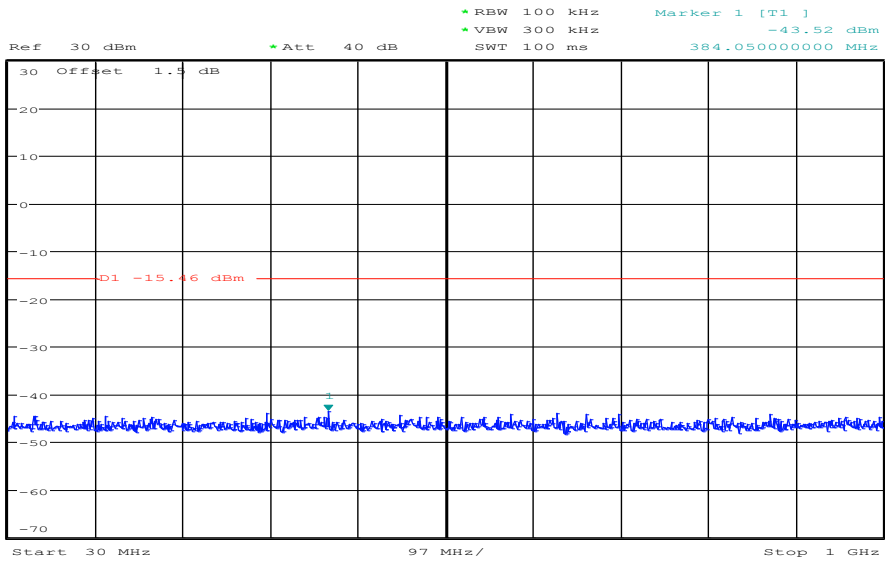

Date: 19.NOV.2018 12:30:11

11B\_ANT1\_2412\_1000~26500

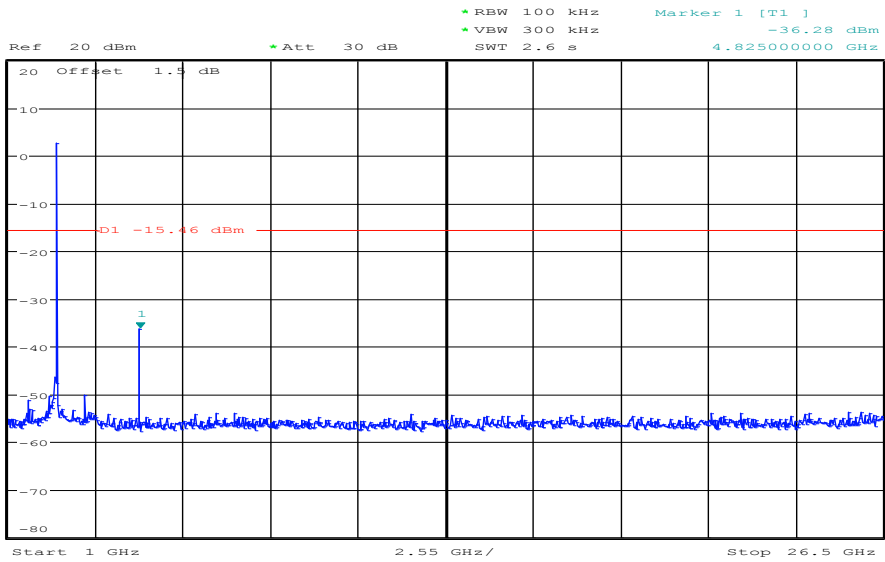

Date: 19.NOV.2018 12:30:23

11B\_ANT1\_2437\_Ref

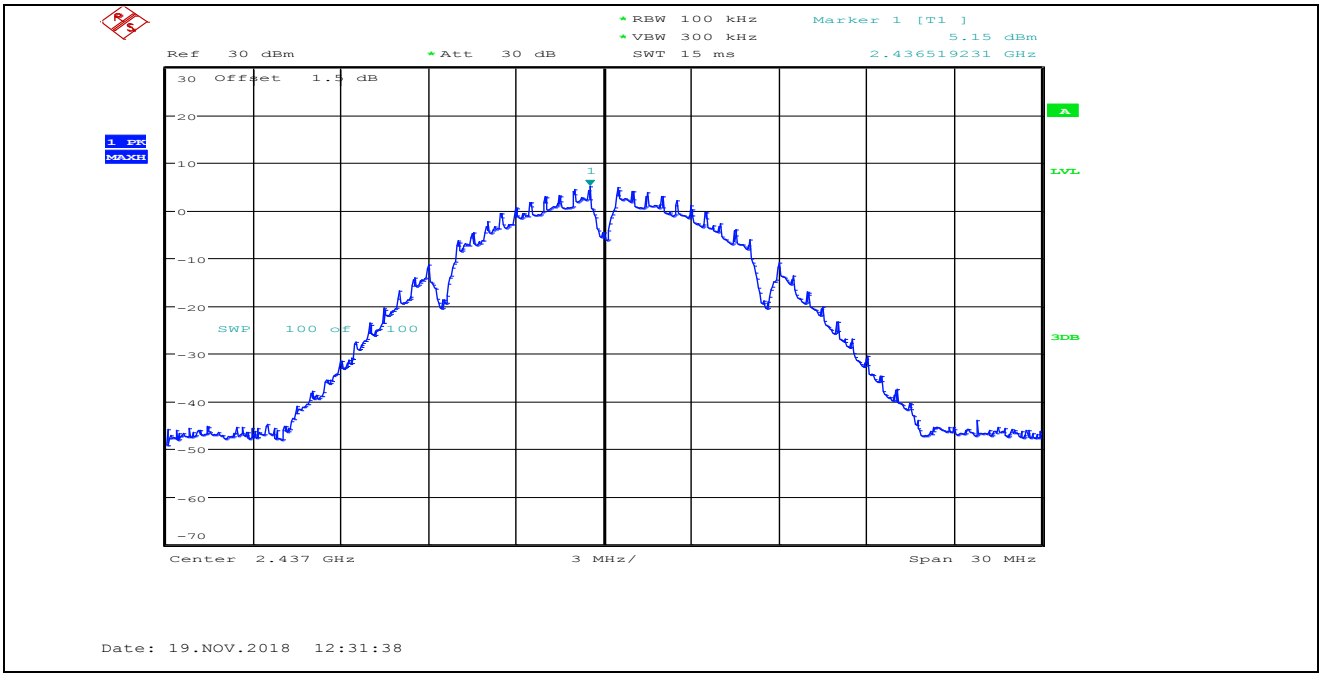

11B\_ANT1\_2437\_30~1000

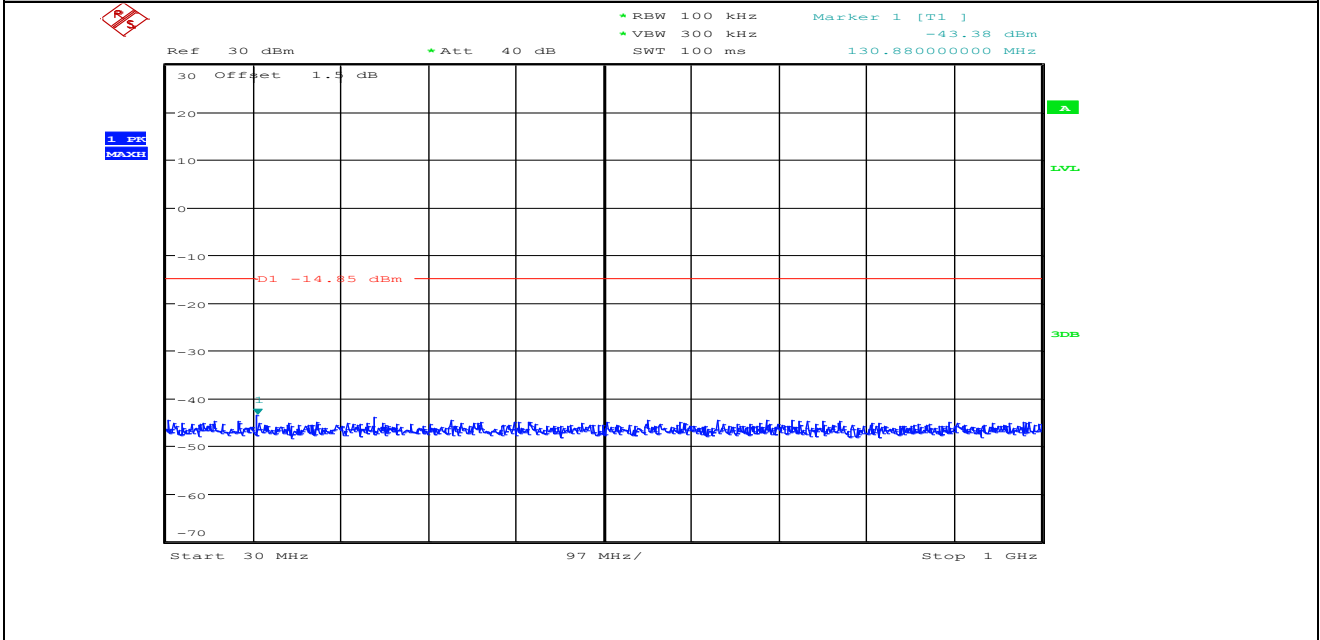

11B\_ANT1\_2437\_1000~26500

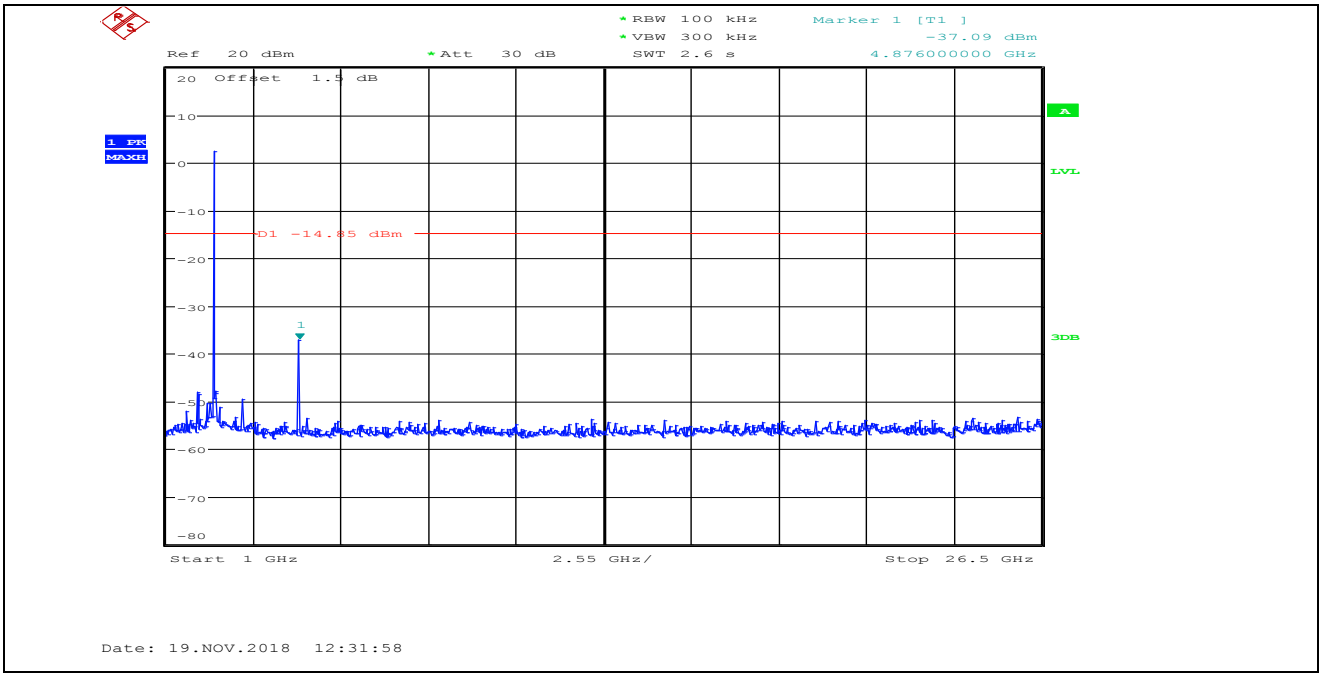

11B\_ANT1\_2462\_Ref

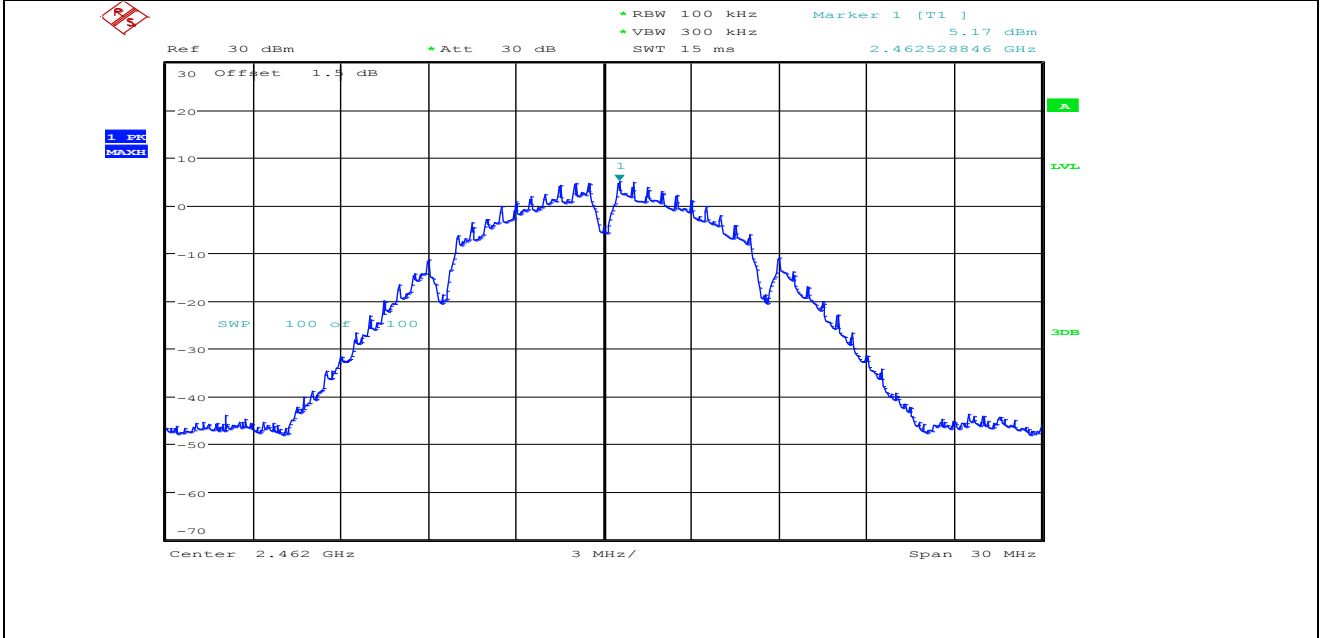

11B\_ANT1\_2462\_30~1000

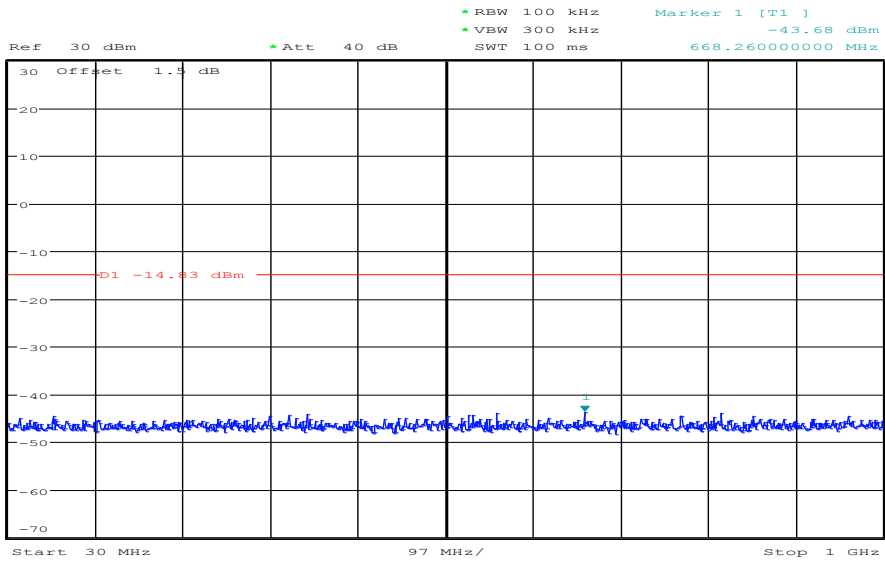

Date: 19.NOV.2018 12:33:19

11B\_ANT1\_2462\_1000~26500

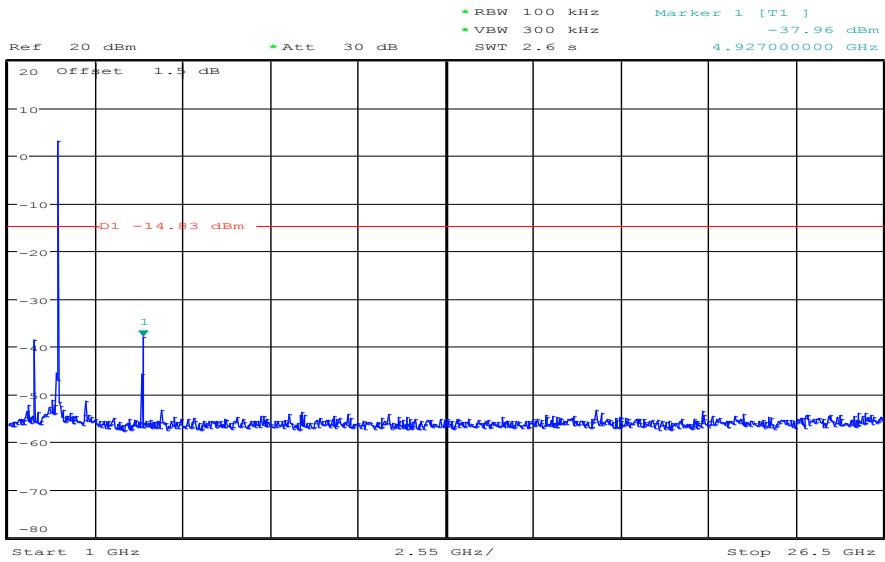

Date: 19.NOV.2018 12:33:30

11G\_ANT1\_2412\_Ref

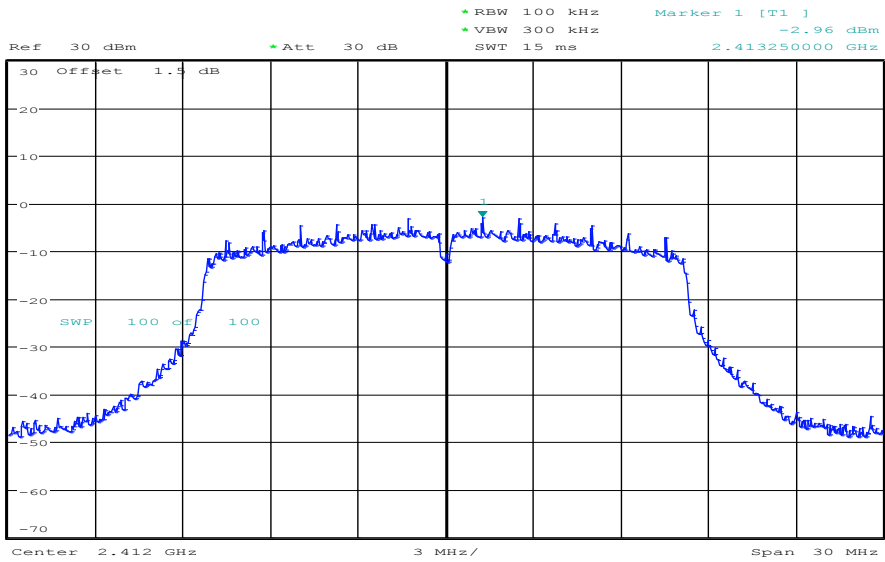

Date: 19.NOV.2018 12:37:12

11G\_ANT1\_2412\_30~1000

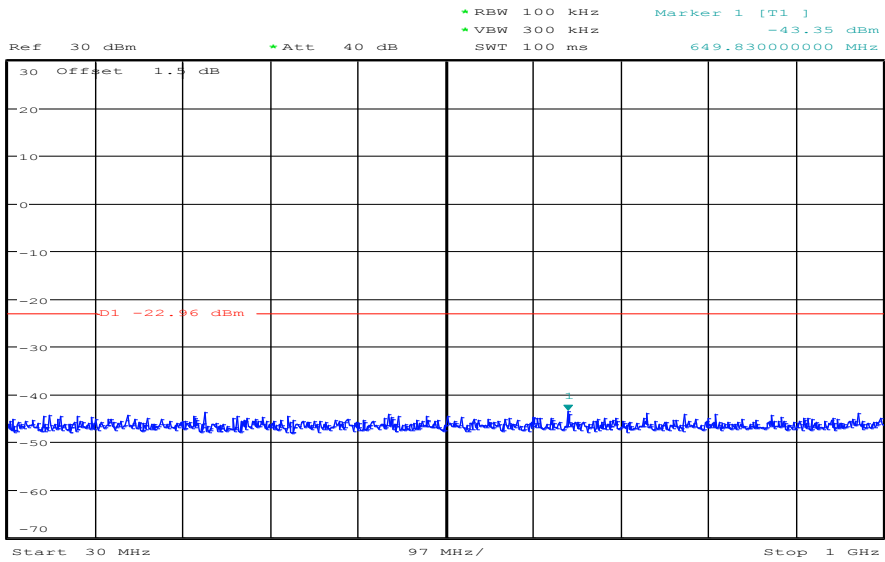

Date: 19.NOV.2018 12:37:21

11G\_ANT1\_2412\_1000~26500

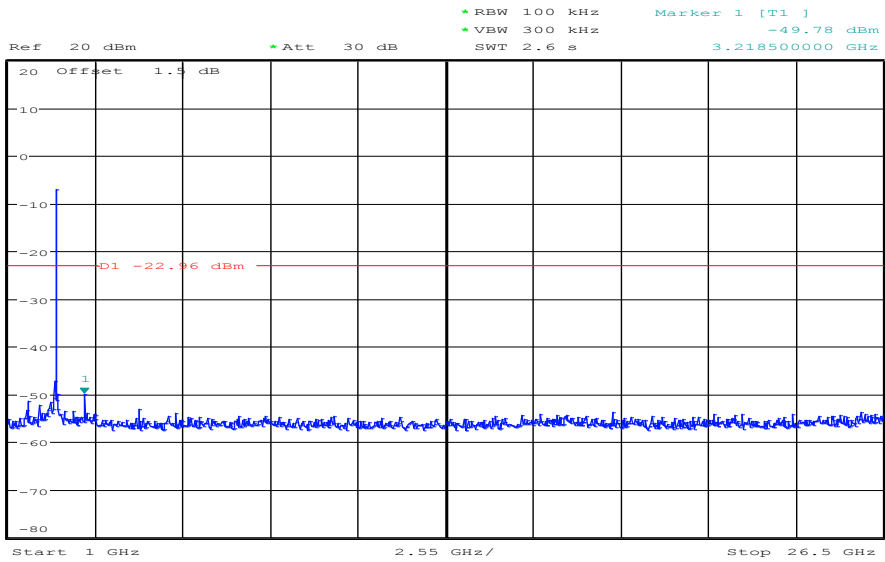

Date: 19.NOV.2018 12:37:32

11G\_ANT1\_2437\_Ref

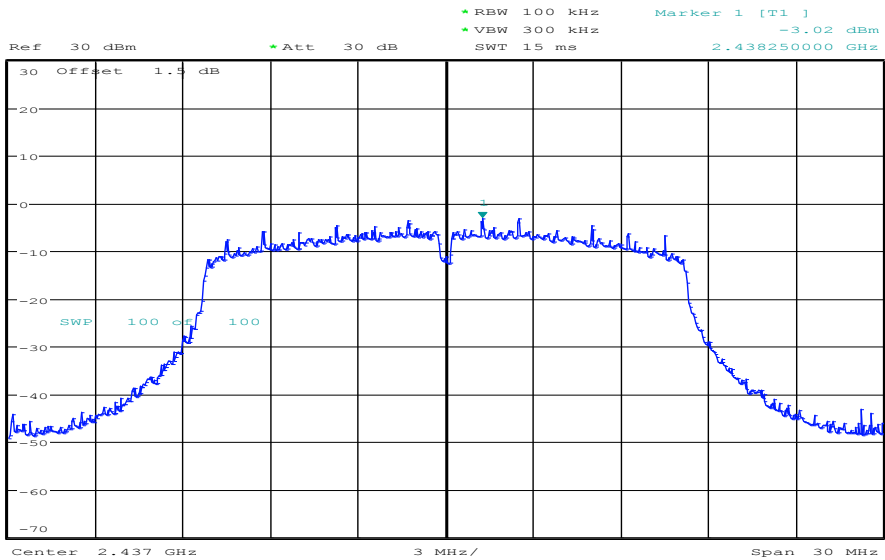

Date: 19.NOV.2018 12:38:38

11G\_ANT1\_2437\_30~1000

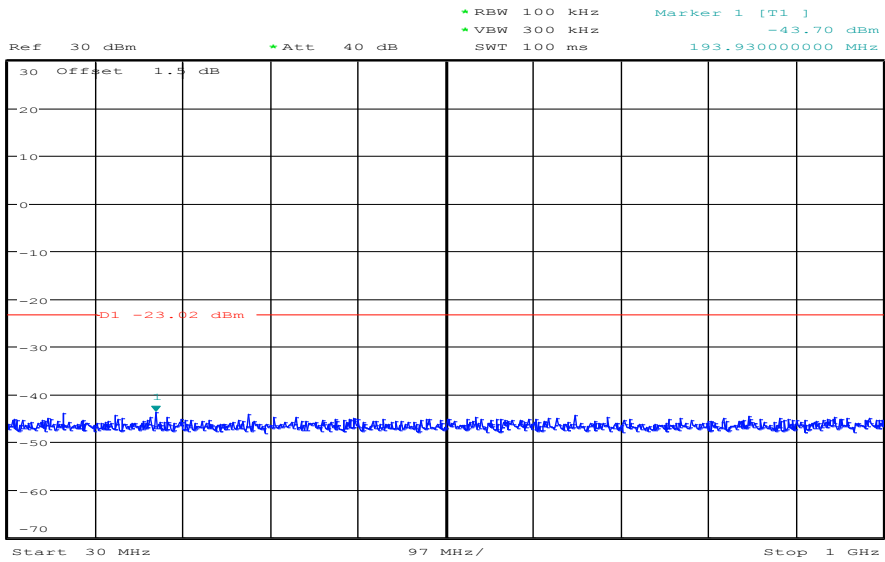

Date: 19.NOV.2018 12:38:47

11G\_ANT1\_2437\_1000~26500

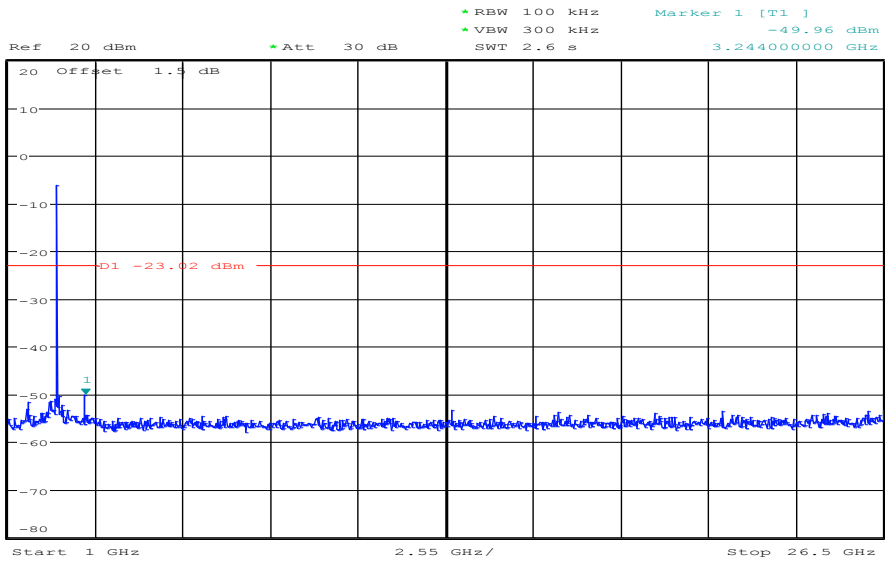

Date: 19.NOV.2018 12:38:58

11G\_ANT1\_2462\_Ref

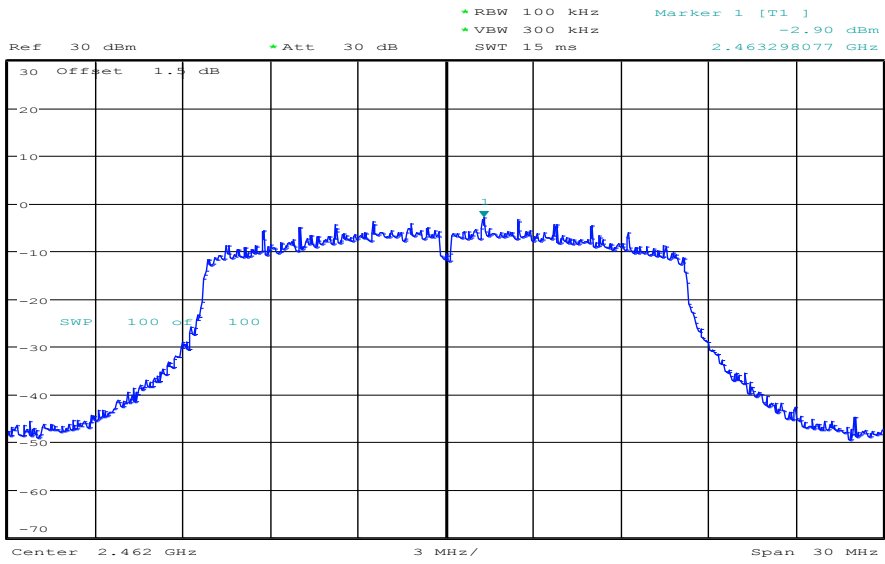

Date: 19.NOV.2018 12:40:12

11G\_ANT1\_2462\_30~1000

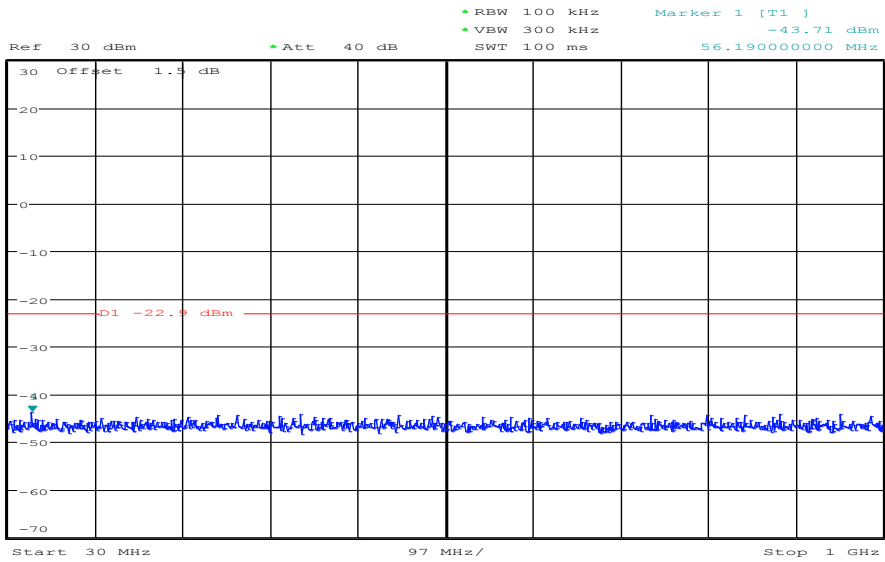

Date: 19.NOV.2018 12:40:21

11G\_ANT1\_2462\_1000~26500



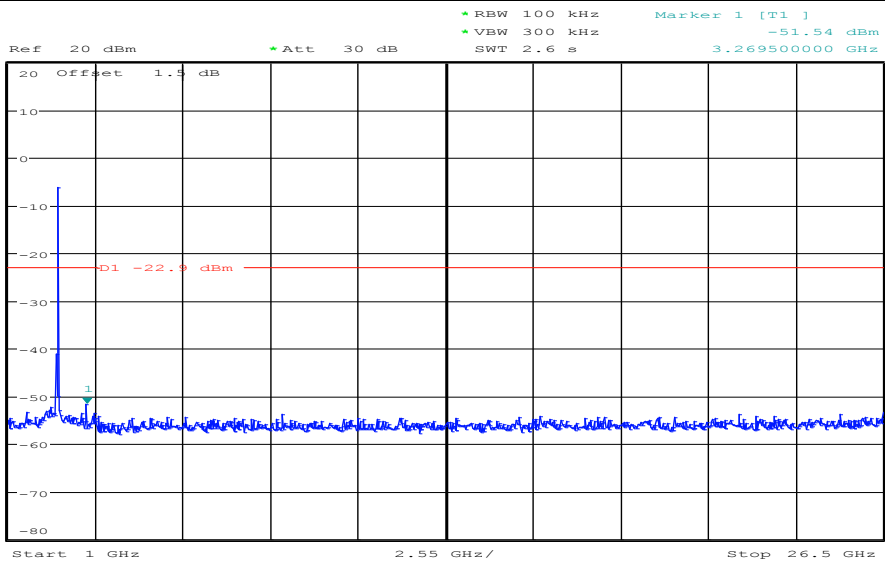

Date: 19.NOV.2018 12:40:33

11N20MIMO\_ANT1\_2412\_Ref

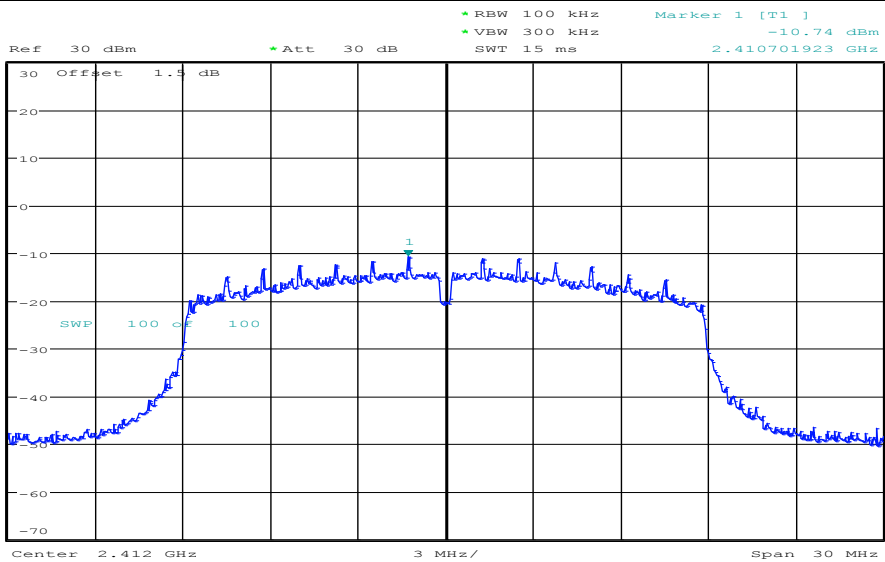

Date: 19.NOV.2018 12:55:19

11N20MIMO\_ANT1\_2412\_30~1000

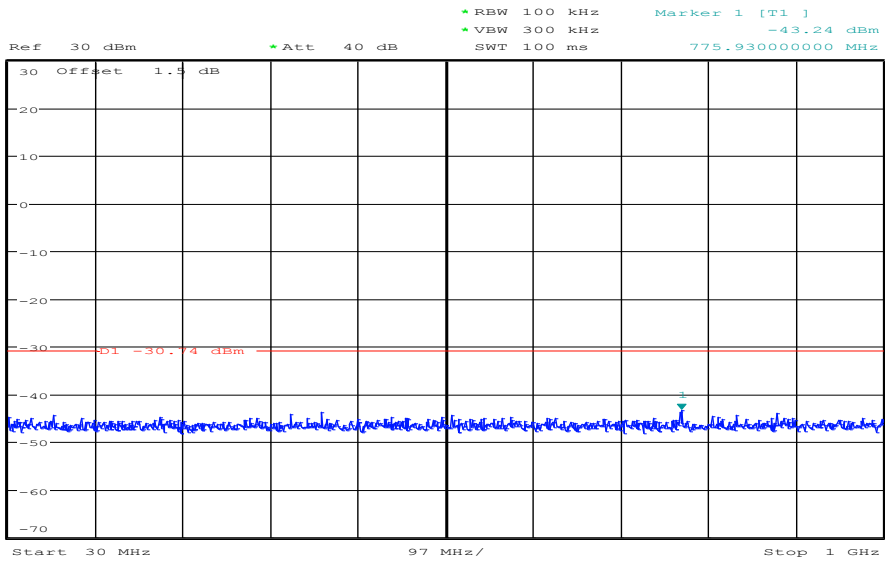

Date: 19.NOV.2018 12:55:27

11N20MIMO\_ANT1\_2412\_1000~26500

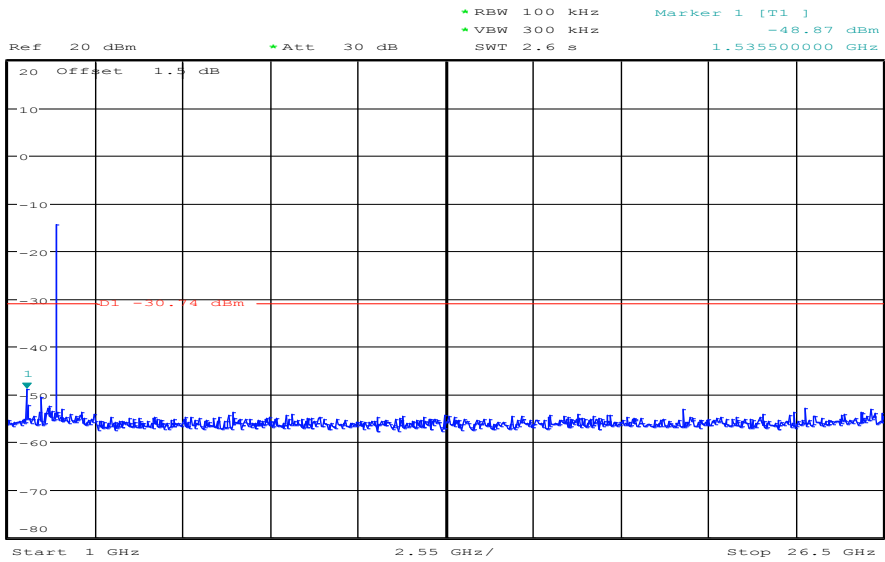

Date: 19.NOV.2018 12:55:39

11N20MIMO\_ANT2\_2412\_Ref

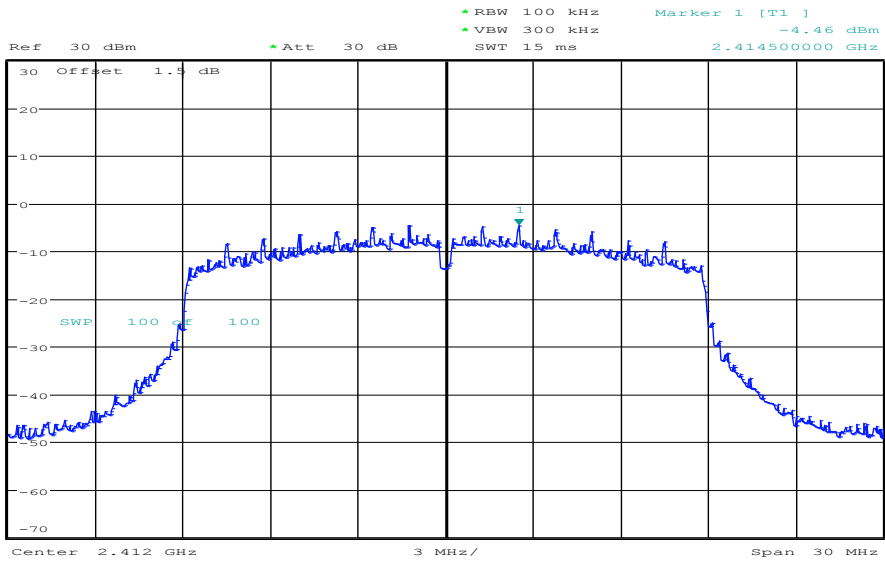

Date: 19.NOV.2018 13:01:33

11N20MIMO\_ANT2\_2412\_30~1000

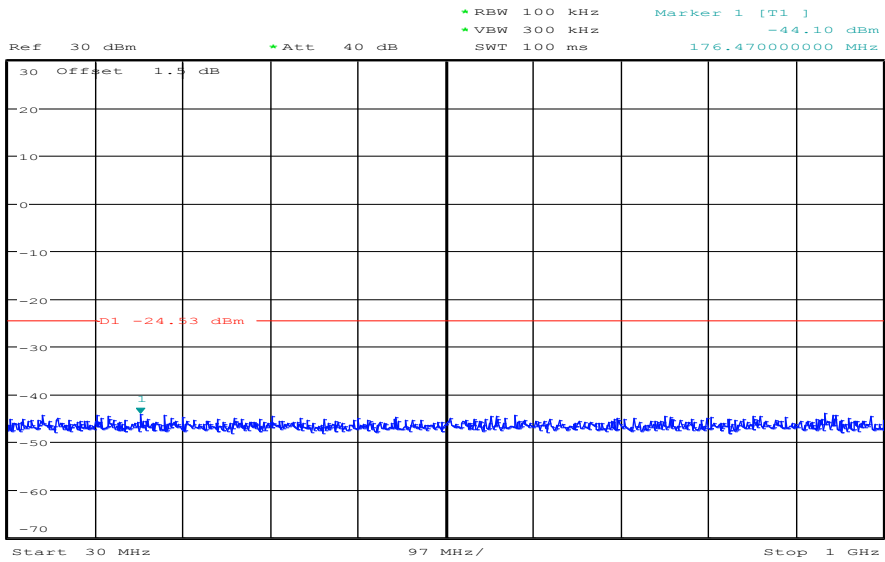

Date: 19.NOV.2018 13:01:41

11N20MIMO\_ANT2\_2412\_1000~26500

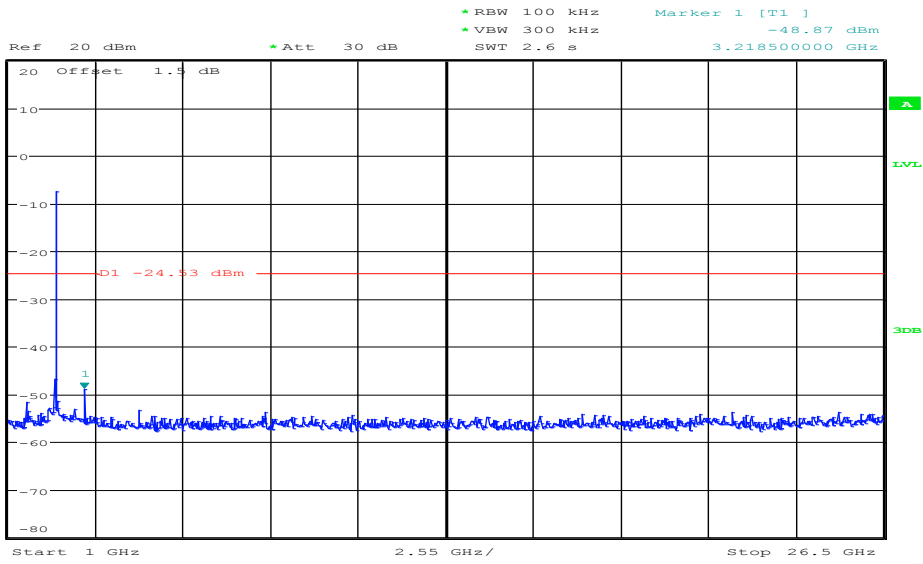

Date: 19.NOV.2018 13:01:53

11N20MIMO\_ANT1\_2437\_Ref

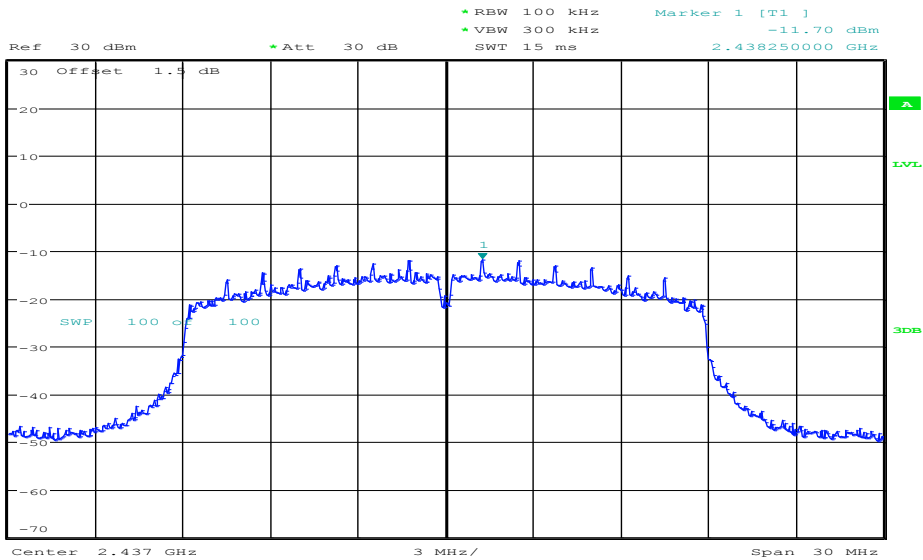

Date: 19.NOV.2018 12:56:44

11N20MIMO\_ANT1\_2437\_30~1000

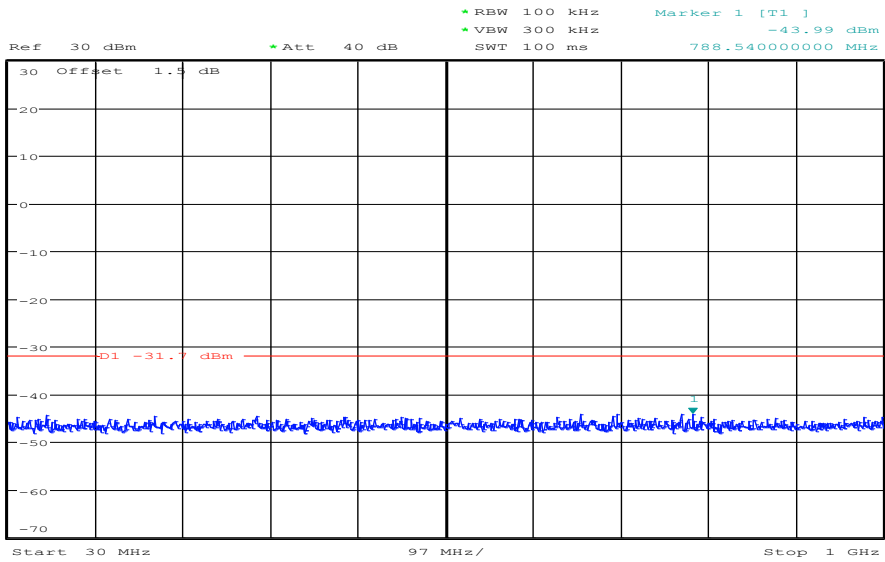

Date: 19.NOV.2018 12:56:53

11N20MIMO\_ANT1\_2437\_1000~26500

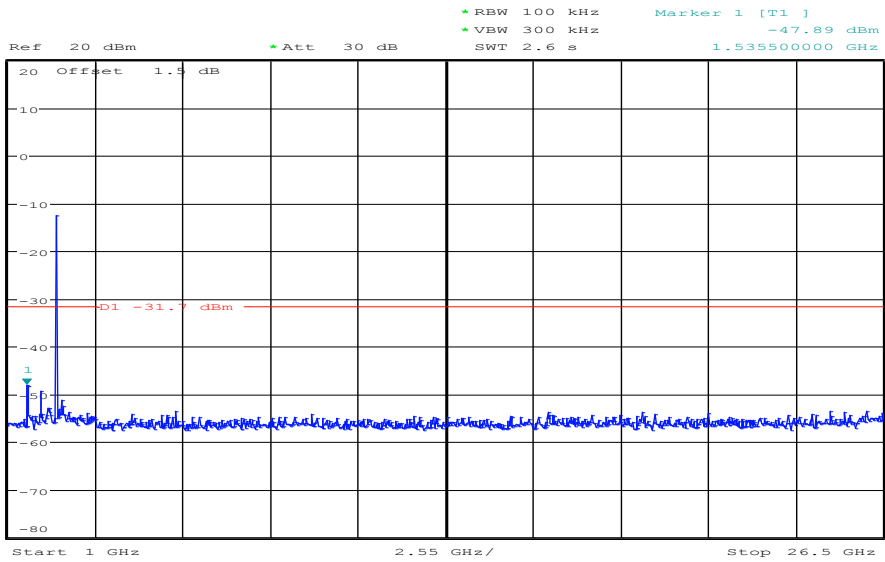

Date: 19.NOV.2018 12:57:05

11N20MIMO\_ANT2\_2437\_Ref

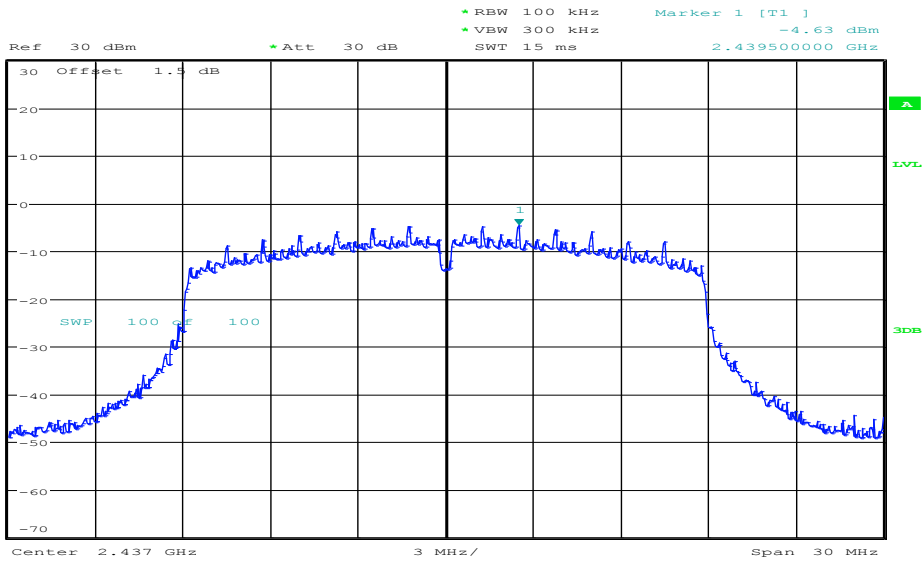

Date: 19.NOV.2018 13:03:50

11N20MIMO\_ANT2\_2437\_30~1000

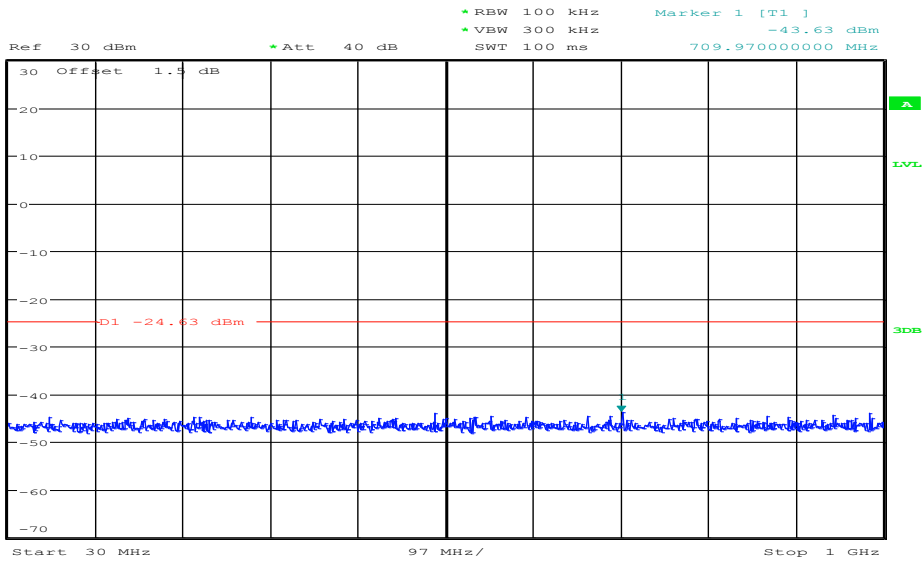

Date: 19.NOV.2018 13:03:59

11N20MIMO\_ANT2\_2437\_1000~26500

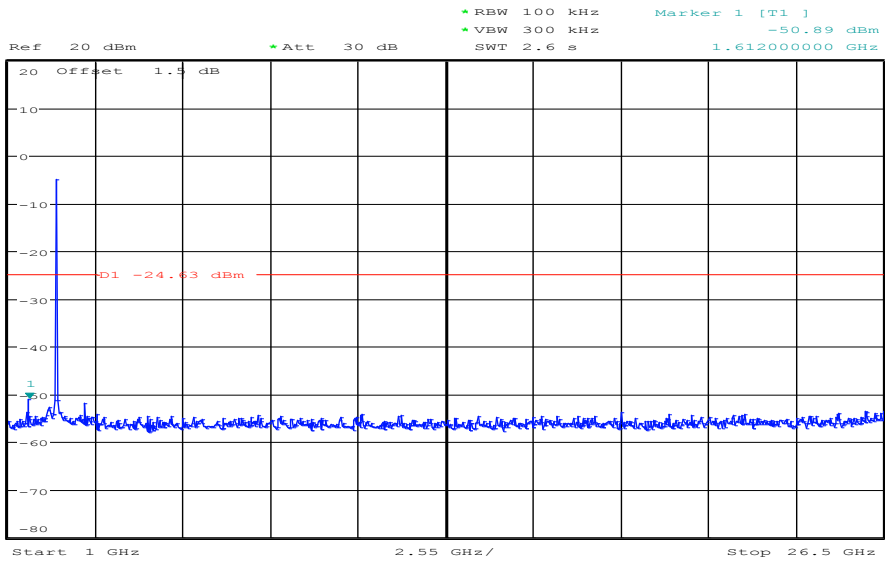

Date: 19.NOV.2018 13:04:11

11N20MIMO\_ANT1\_2462\_Ref

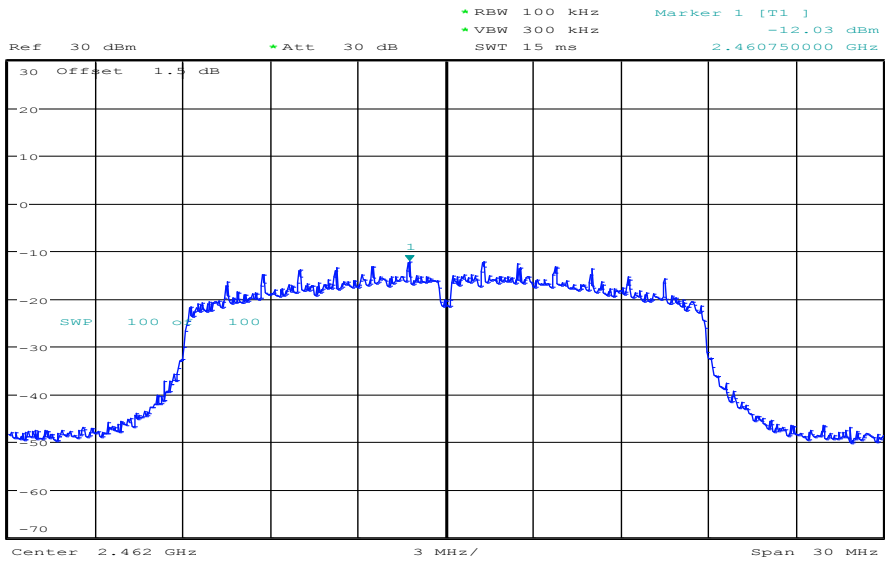

Date: 19.NOV.2018 12:58:59

11N20MIMO\_ANT1\_2462\_30~1000

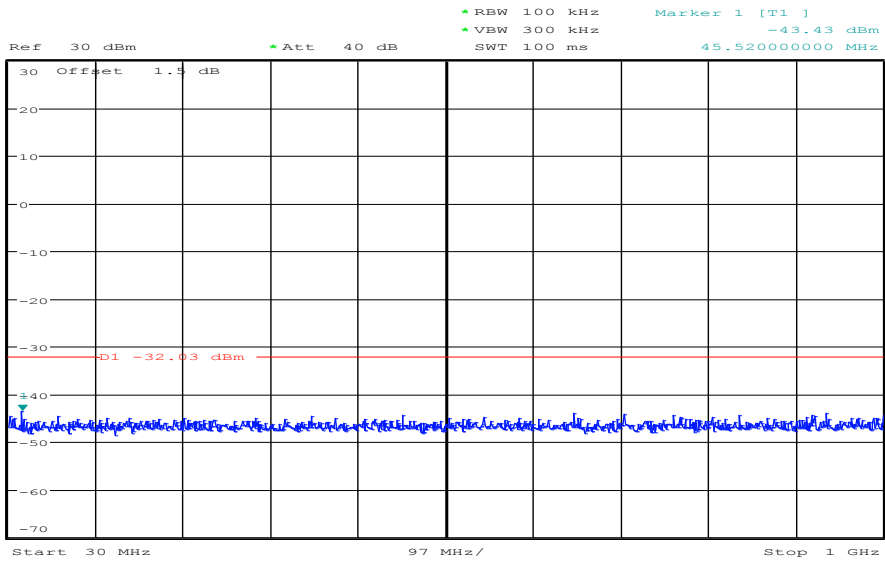

Date: 19.NOV.2018 12:59:07

11N20MIMO\_ANT1\_2462\_1000~26500

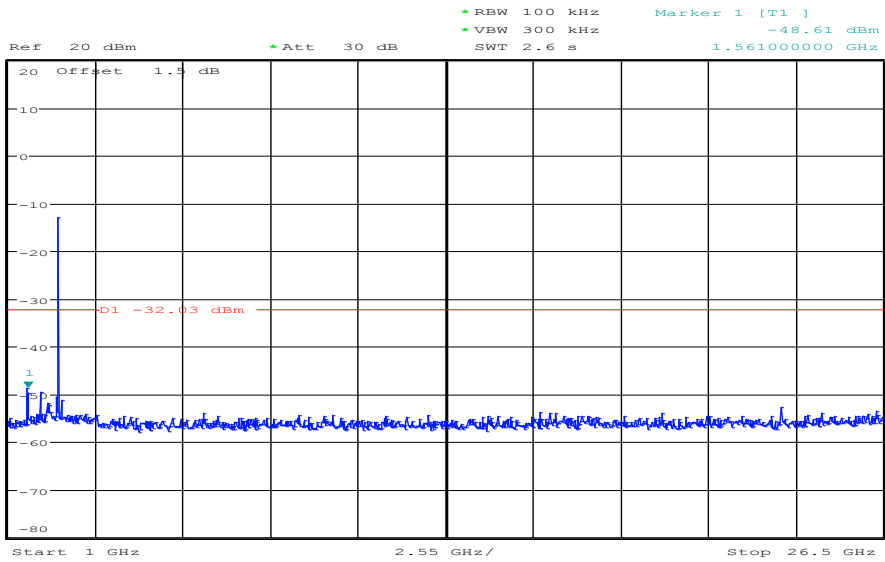

Date: 19.NOV.2018 12:59:19

11N20MIMO\_ANT2\_2462\_Ref



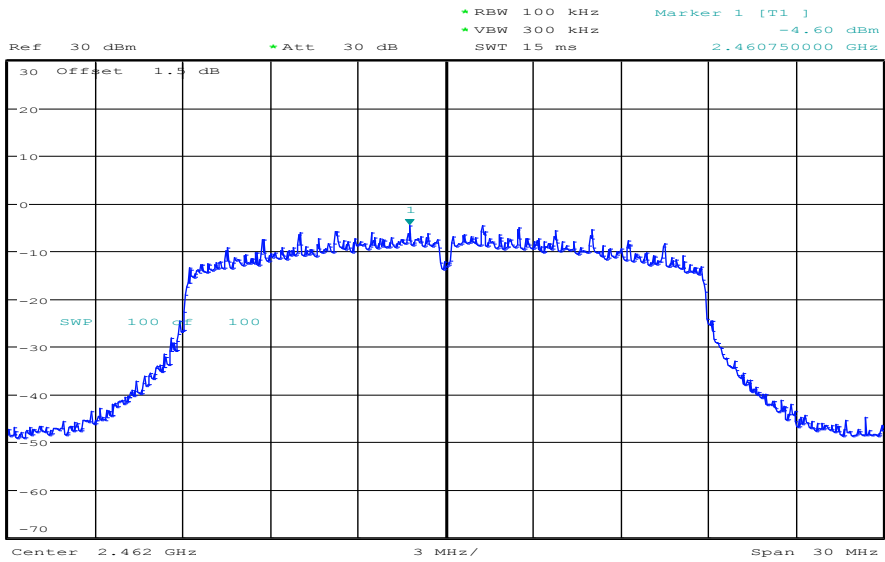

Date: 19.NOV.2018 13:05:22

11N20MIMO\_ANT2\_2462\_30~1000

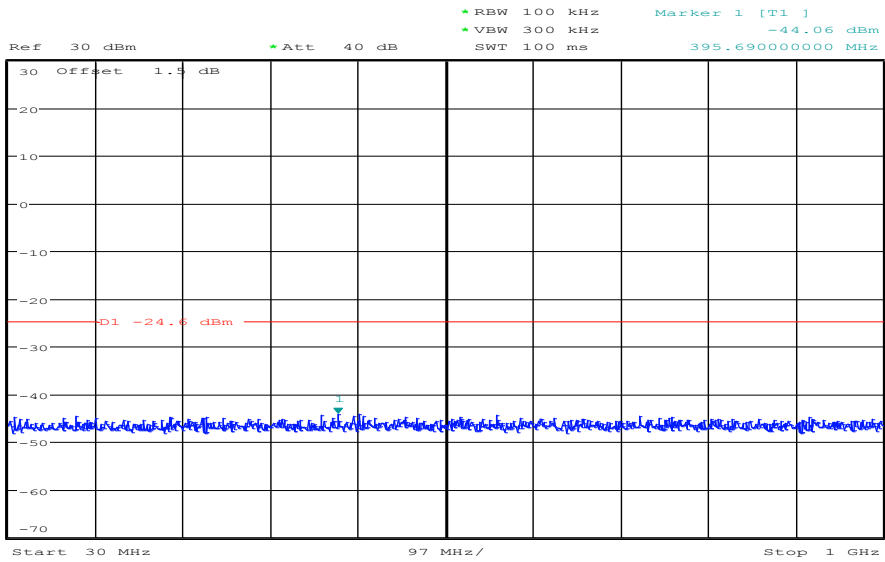

Date: 19.NOV.2018 13:05:31

11N20MIMO\_ANT2\_2462\_1000~26500

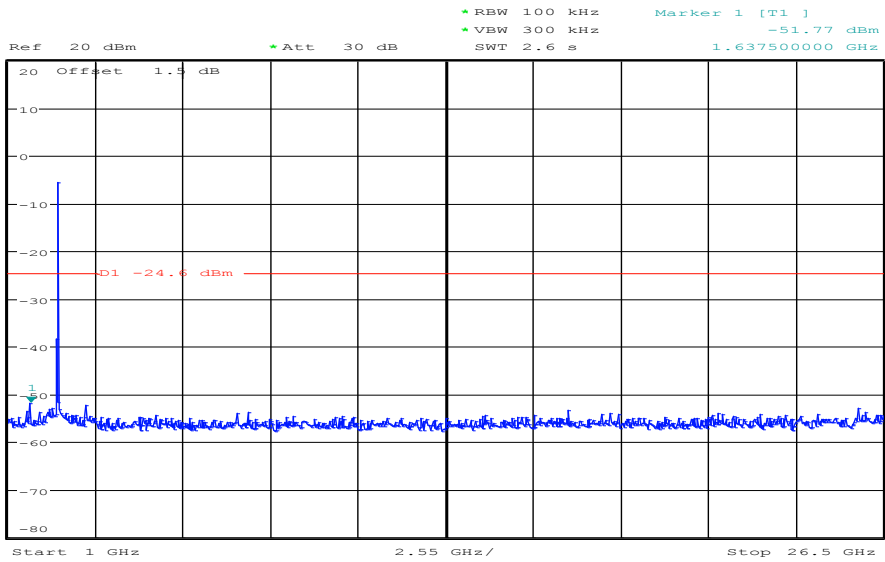

Date: 19.NOV.2018 13:05:42

11N40MIMO\_ANT1\_2422\_Ref

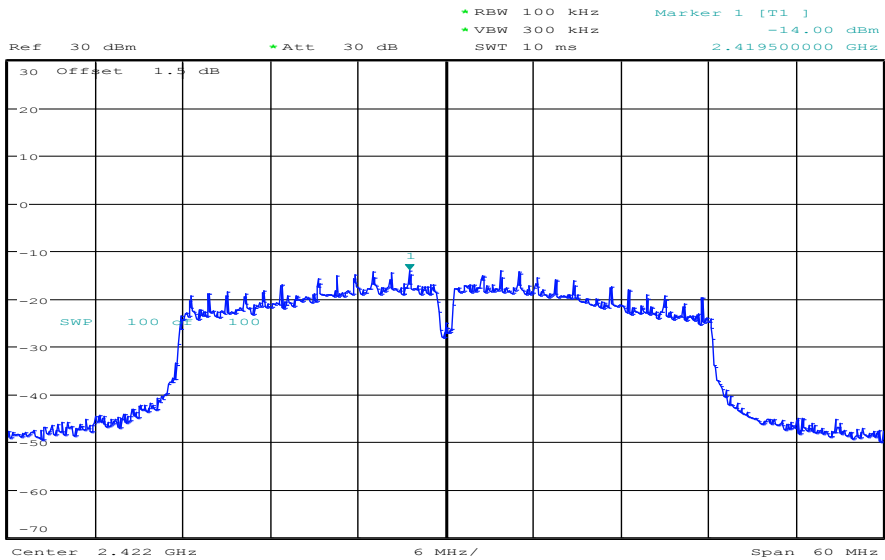

Date: 19.NOV.2018 13:11:14

11N40MIMO\_ANT1\_2422\_30~1000

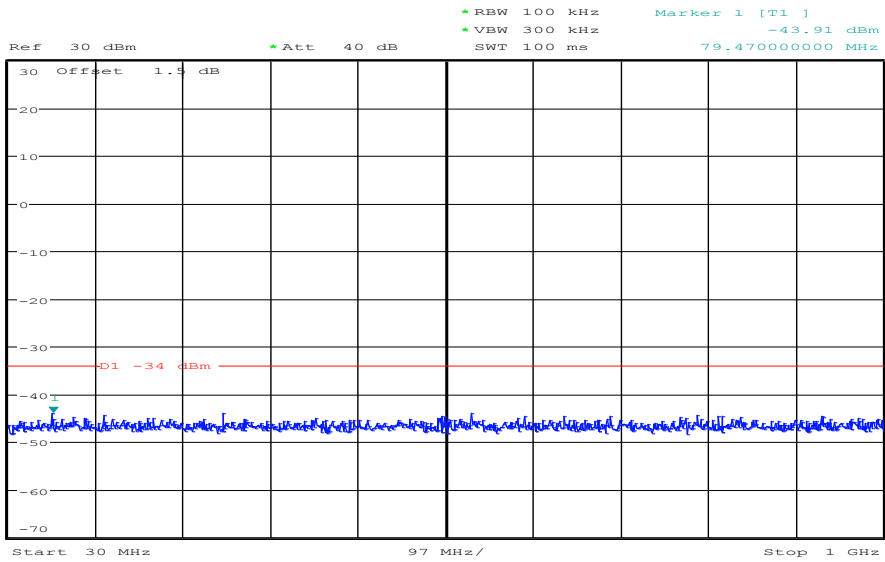

Date: 19.NOV.2018 13:11:23

11N40MIMO\_ANT1\_2422\_1000~26500

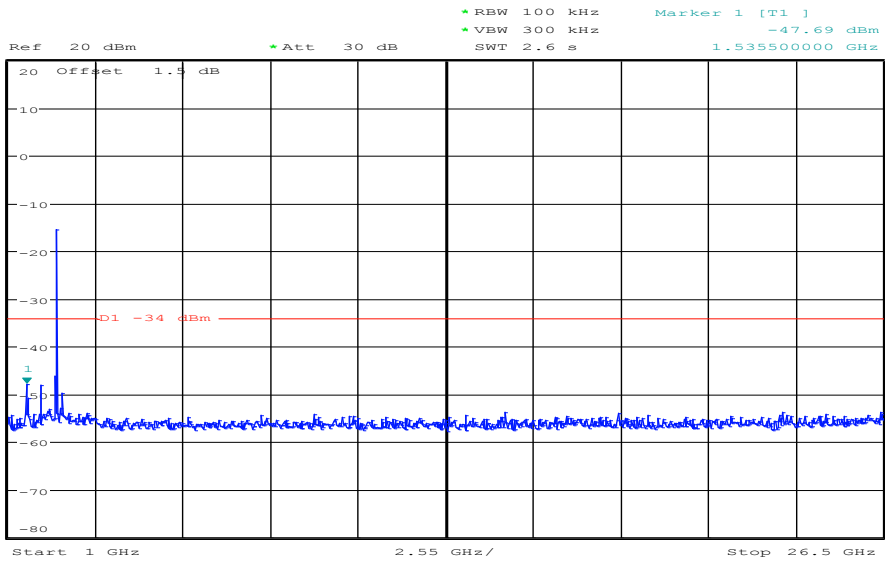

Date: 19.NOV.2018 13:11:35

11N40MIMO\_ANT2\_2422\_Ref

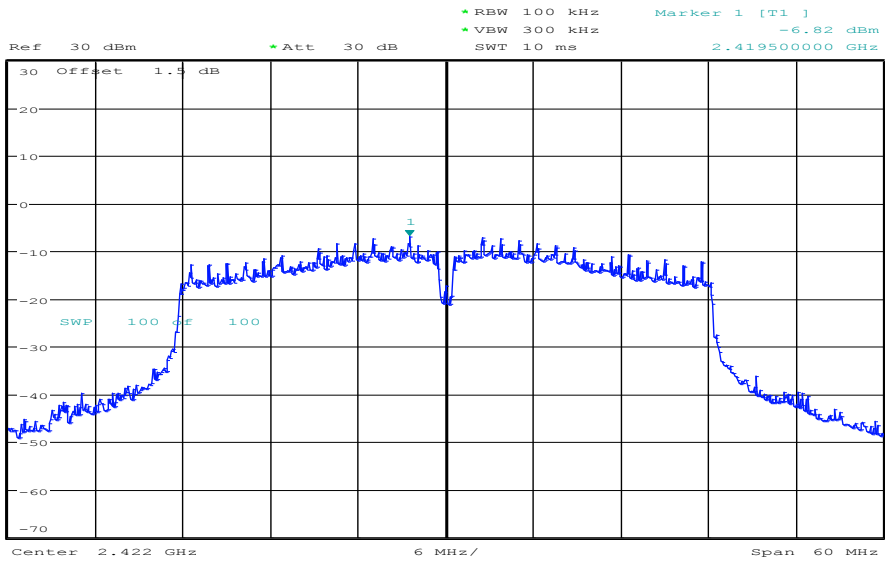

Date: 19.NOV.2018 13:18:31

11N40MIMO\_ANT2\_2422\_30~1000

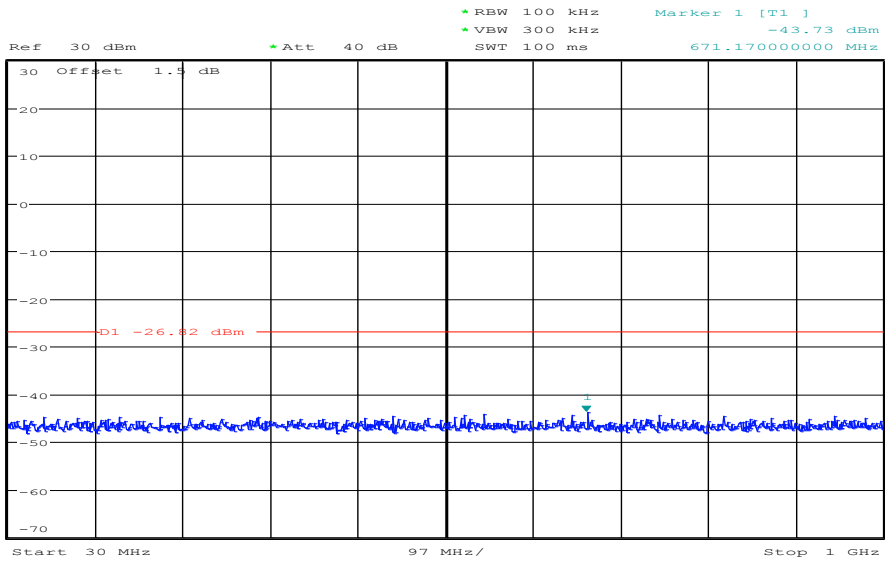

Date: 19.NOV.2018 13:18:40

11N40MIMO\_ANT2\_2422\_1000~26500

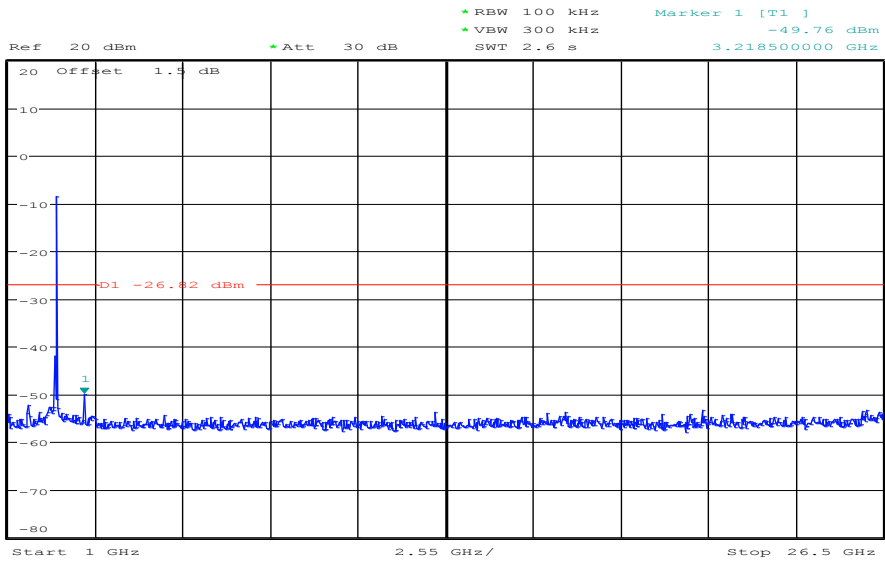

Date: 19.NOV.2018 13:18:52

11N40MIMO\_ANT1\_2437\_Ref

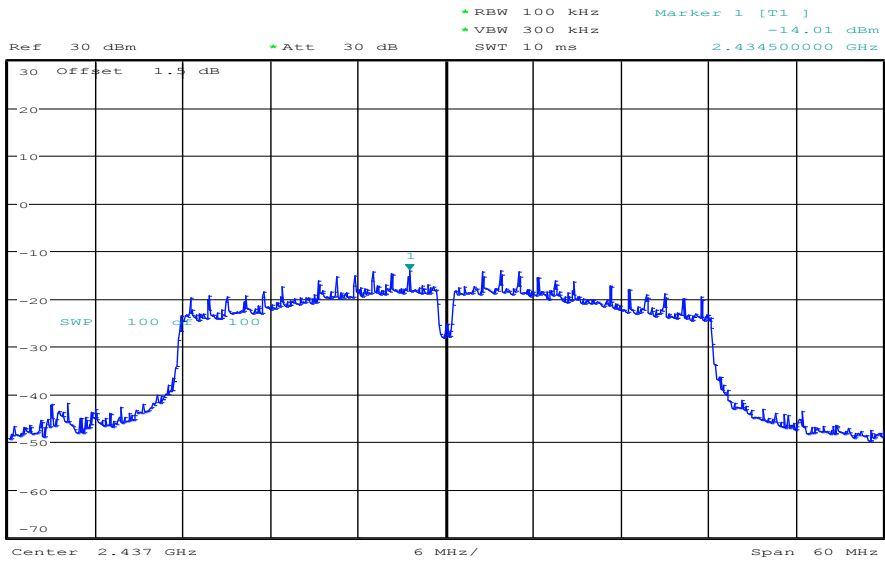

Date: 19.NOV.2018 13:13:06

11N40MIMO\_ANT1\_2437\_30~1000

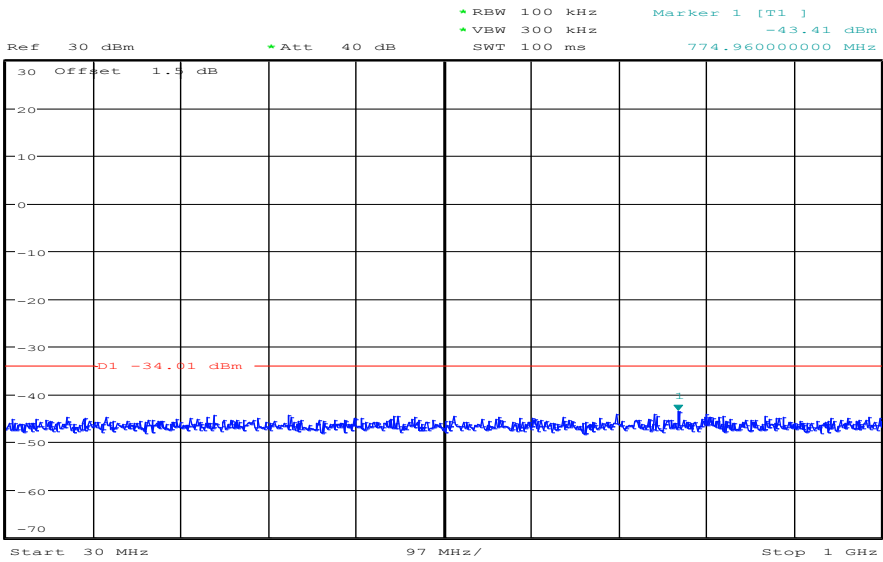

Date: 19.NOV.2018 13:13:14

11N40MIMO\_ANT1\_2437\_1000~26500

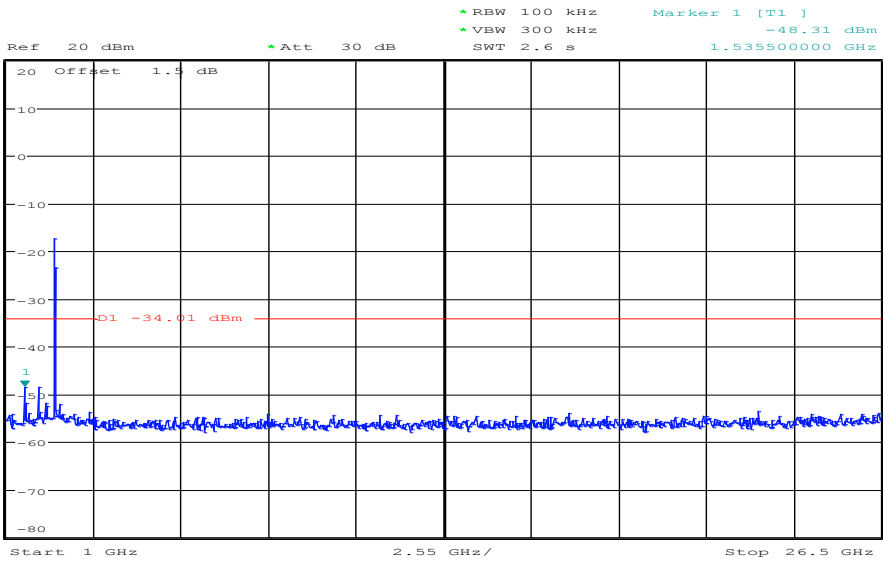

Date: 19.NOV.2018 13:13:26

11N40MIMO\_ANT2\_2437\_Ref

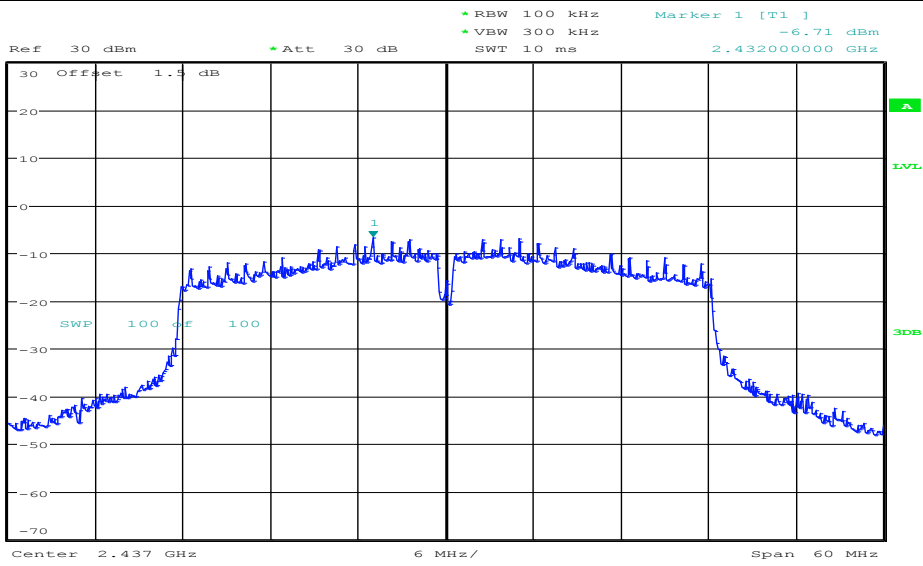

Date: 19.NOV.2018 13:20:09

11N40MIMO\_ANT2\_2437\_30~1000

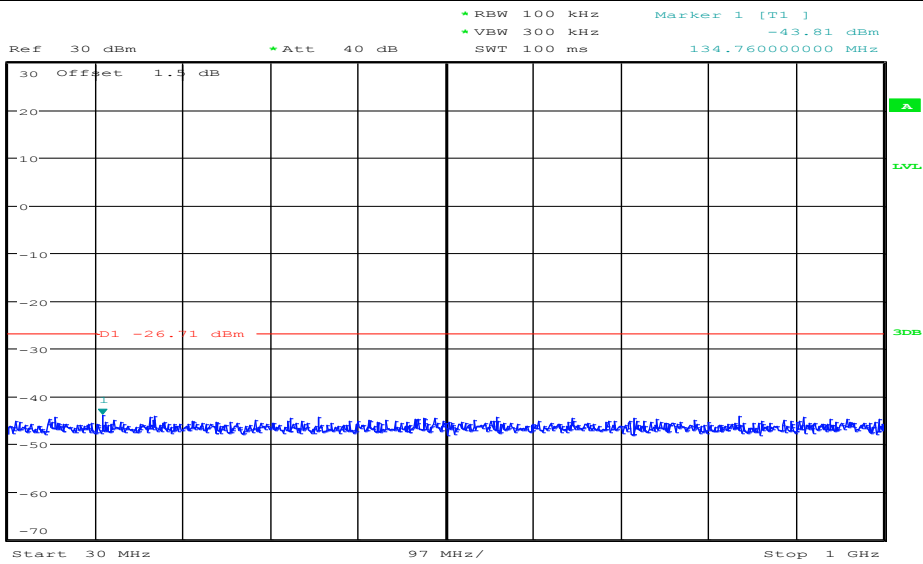

Date: 19.NOV.2018 13:20:18

11N40MIMO\_ANT2\_2437\_1000~26500

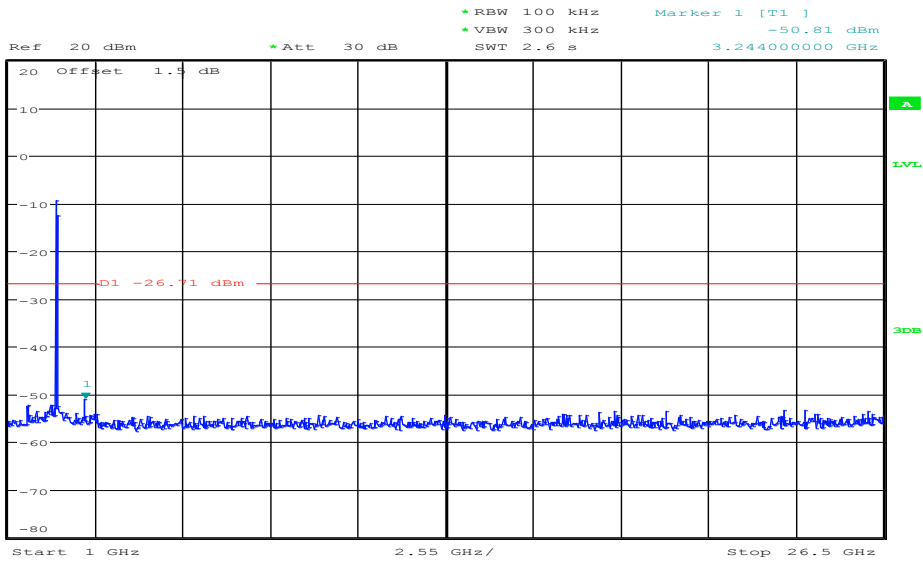

Date: 19.NOV.2018 13:20:29

11N40MIMO\_ANT1\_2452\_Ref

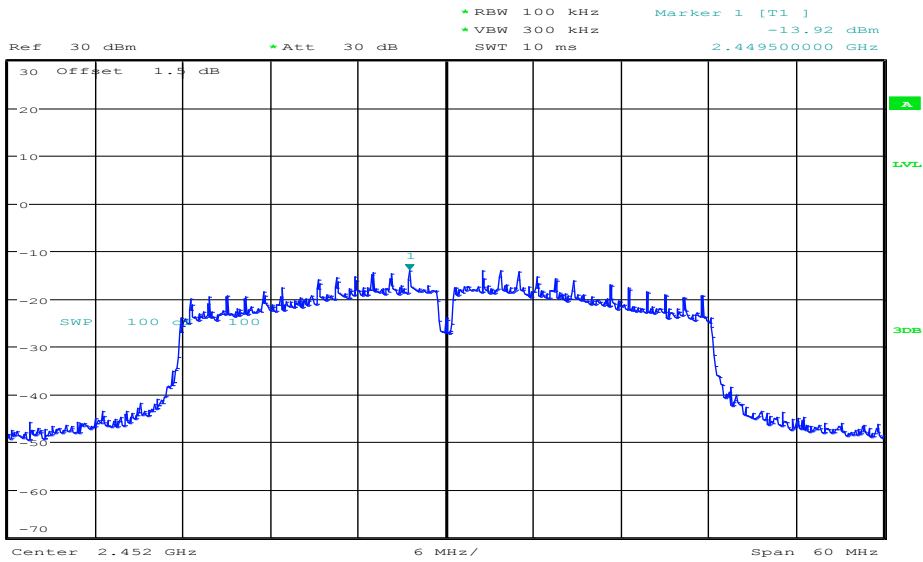

Date: 19.NOV.2018 13:15:52

11N40MIMO\_ANT1\_2452\_30~1000



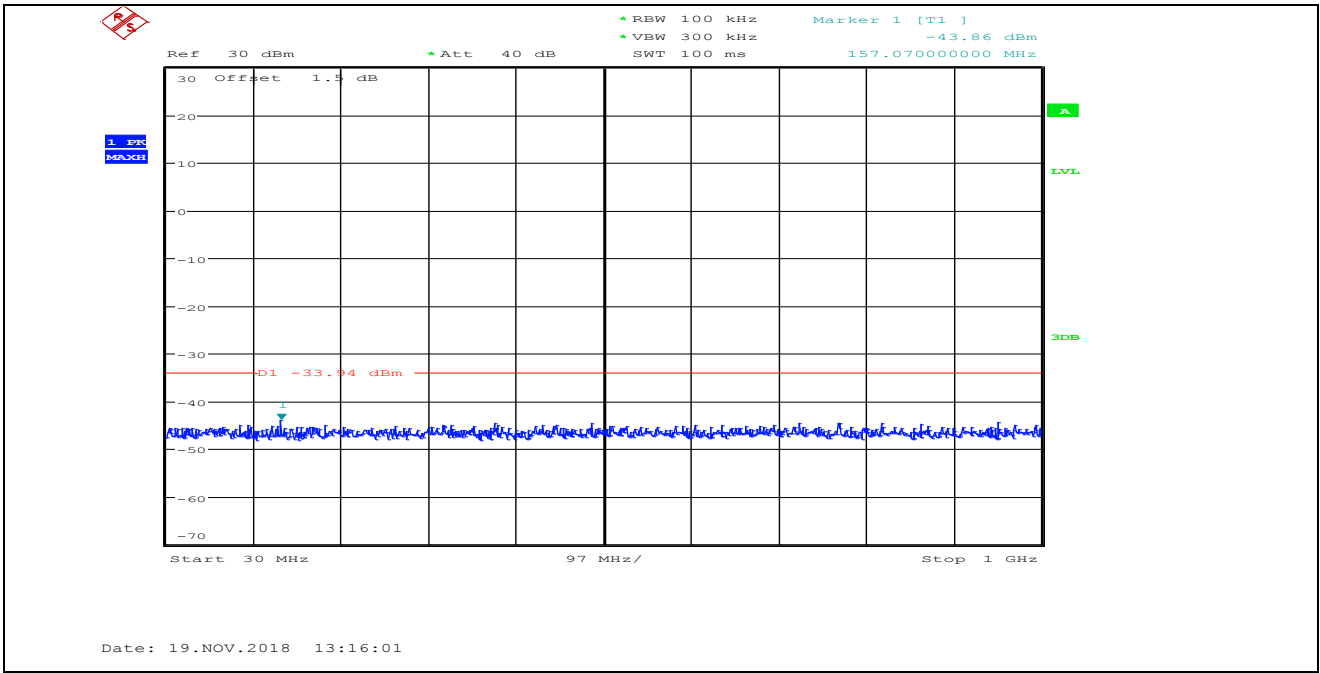

11N40MIMO\_ANT1\_2452\_1000~26500

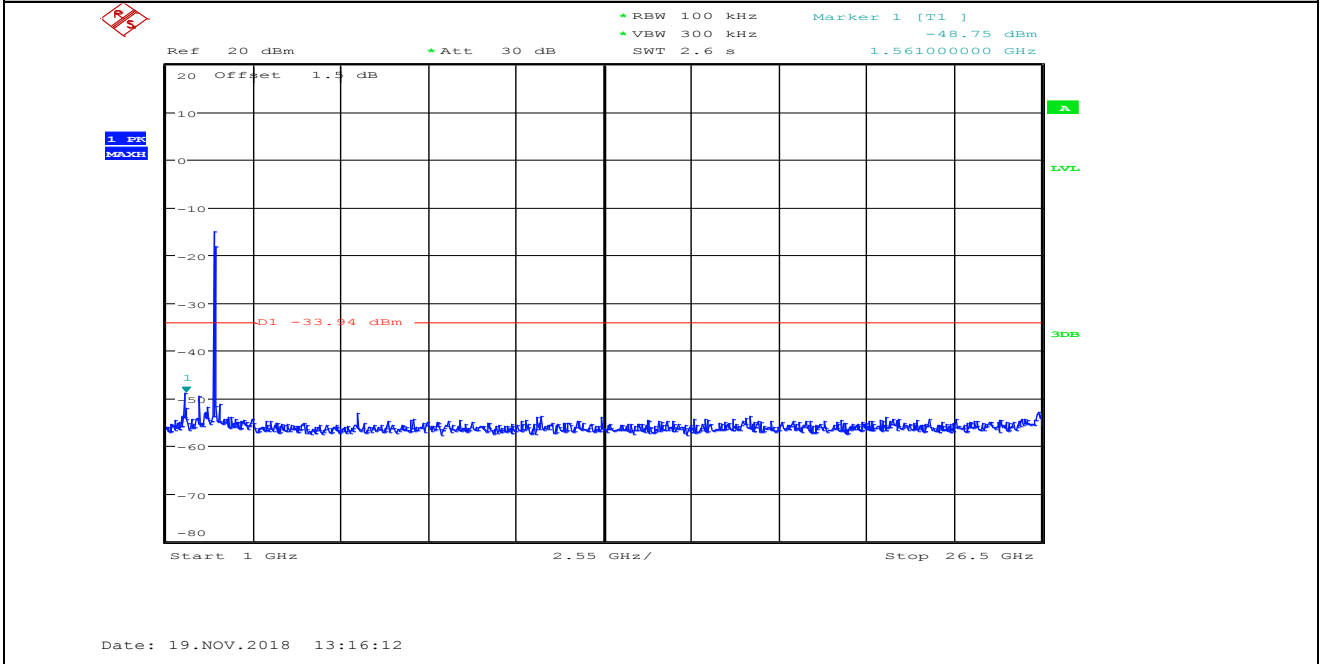

11N40MIMO\_ANT2\_2452\_Ref

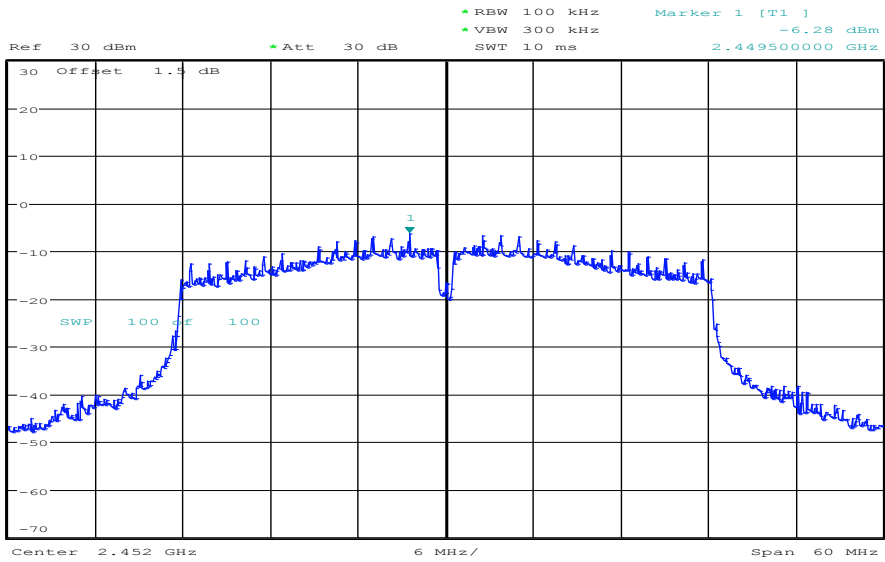

Date: 19.NOV.2018 13:21:49

11N40MIMO\_ANT2\_2452\_30~1000

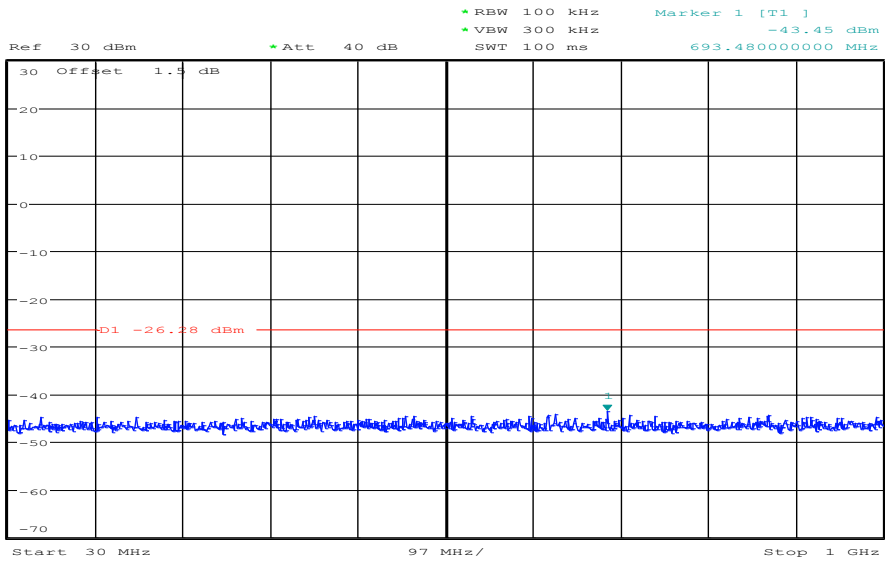

Date: 19.NOV.2018 13:21:58

11N40MIMO\_ANT2\_2452\_1000~26500

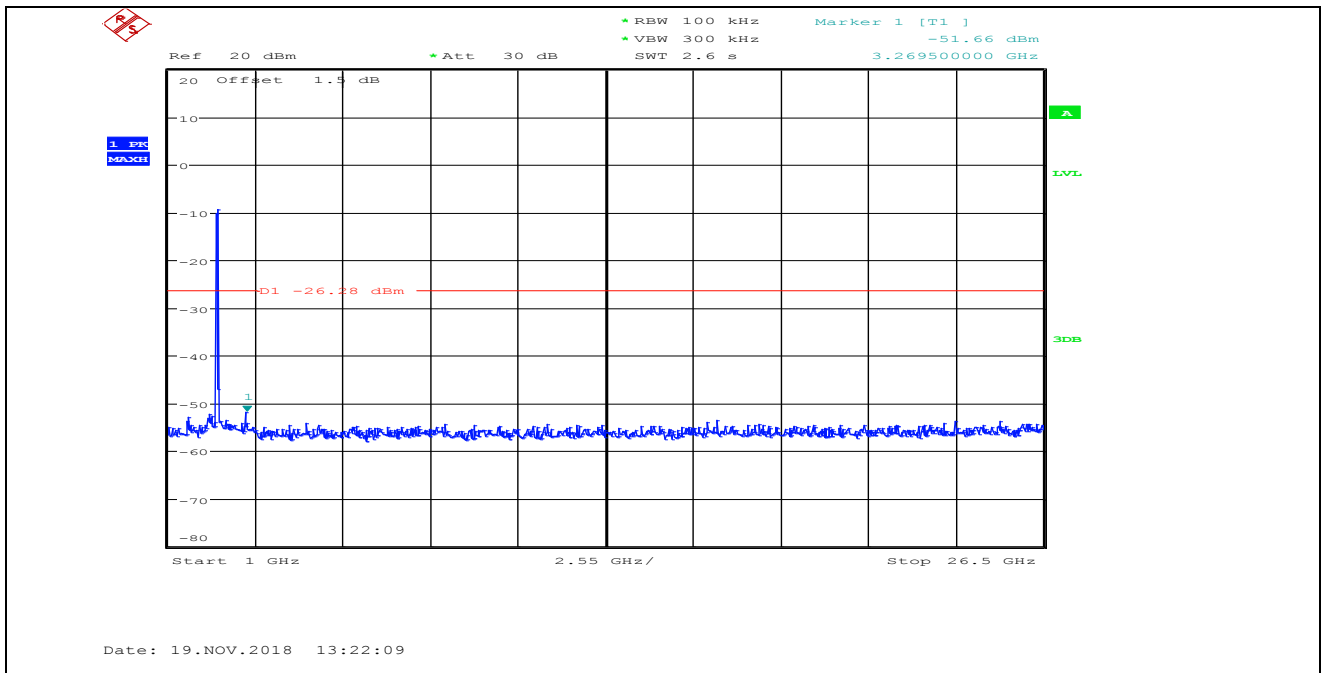

## 8. Radiated Spurious Emissions

### 8.1. Block diagram of test setup

In 3m Anechoic Chamber Test Setup Diagram for 9kHz-30MHz

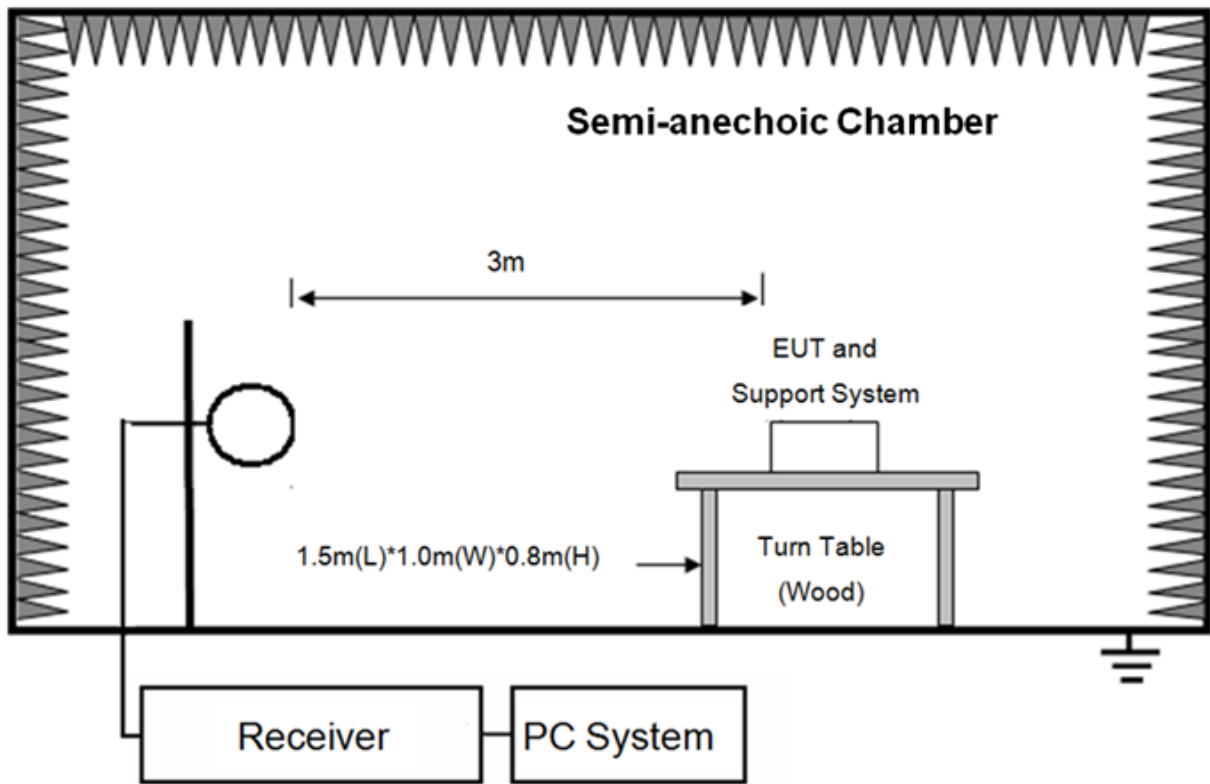

In 3m Anechoic Chamber Test Setup Diagram for 30MHz-1GHz

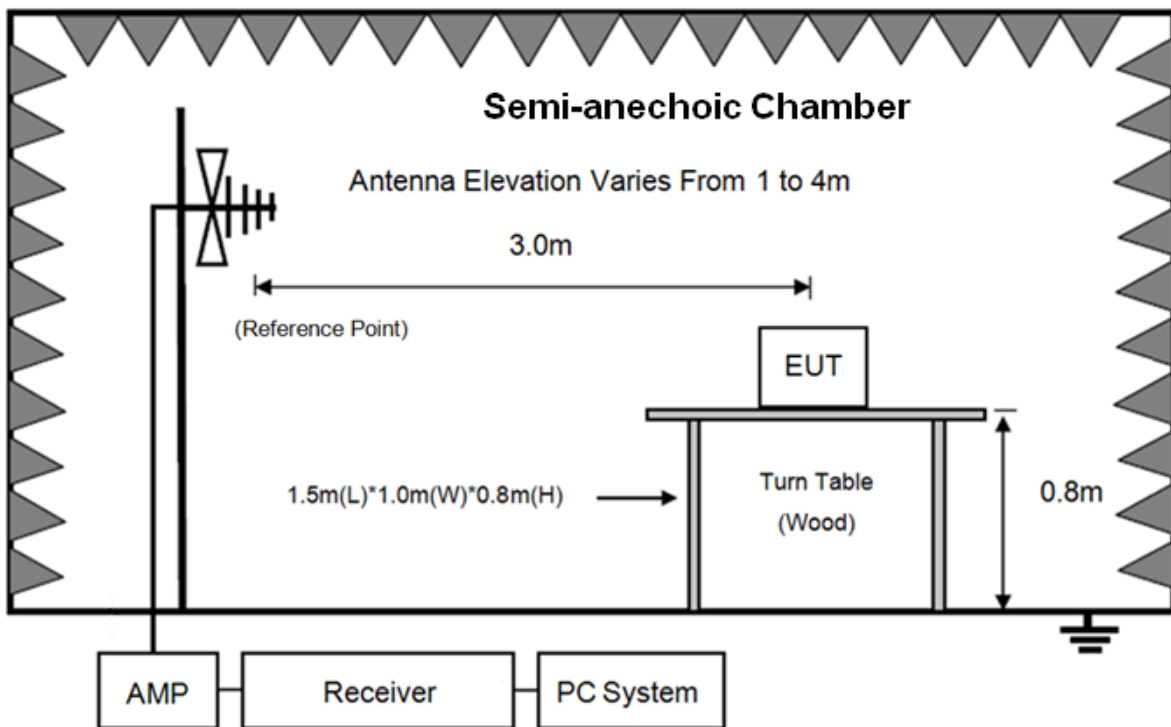

In 3m Anechoic Chamber Test Setup Diagram for frequency above 1GHz

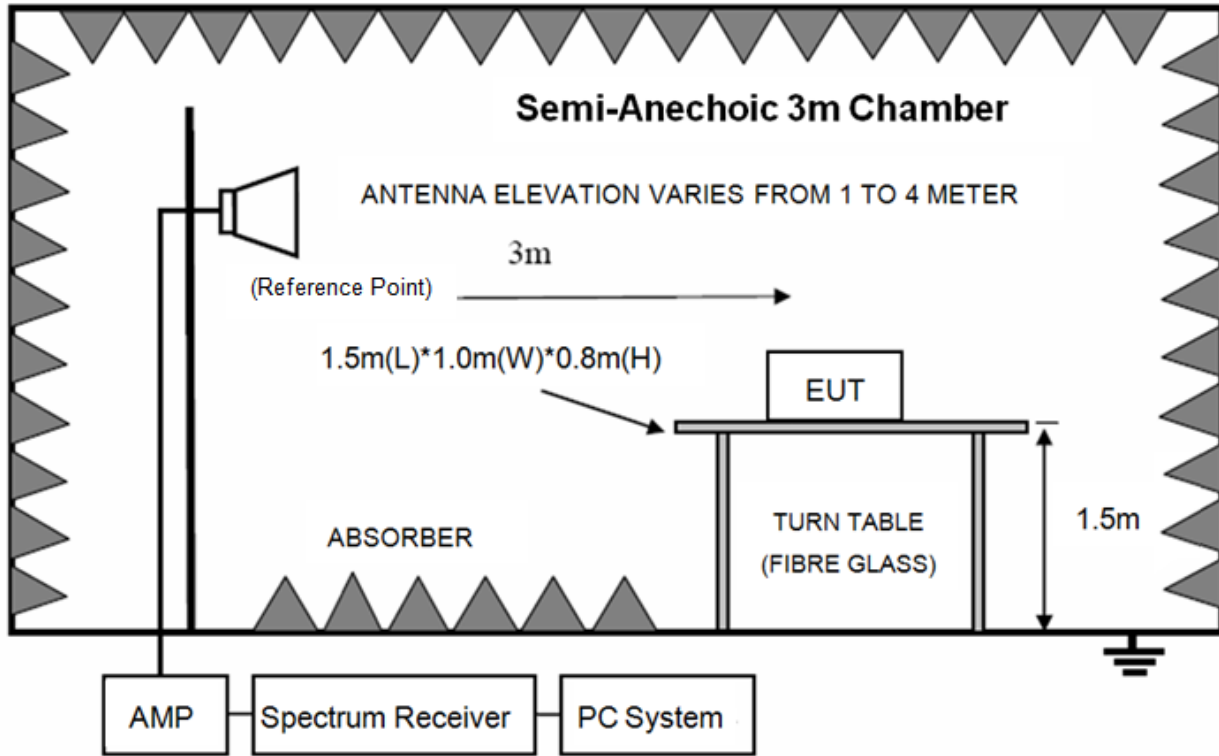

Note: For harmonic emissions test an appropriate high pass filter was inserted in the input port of AMP.

**8.2. Limit**

8.2.1 FCC 15.205 Restricted frequency band

| MHz               | MHz                 | MHz           | GHz              |
|-------------------|---------------------|---------------|------------------|
| 0.090-0.110       | 16.42-16.423        | 399.9-410     | 4.5-5.15         |
| 10.495-0.505      | 16.69475-16.69525   | 608-614       | 5.35-5.46        |
| 2.1735-2.1905     | 16.80425-16.80475   | 960-1240      | 7.25-7.75        |
| 4.125-4.128       | 25.5-25.67          | 1300-1427     | 8.025-8.5        |
| 4.1772&4.17775    | 37.5-38.25          | 1435-1626.5   | 9.0-9.2          |
| 4.2072&4.20775    | 73-74.6             | 1645.5-1646.5 | 9.3-9.5          |
| 6.215-6.218       | 74.8-75.2           | 1660-1710     | 10.6-12.7        |
| 6.26775-6.26825   | 108-121.94          | 1718.8-1722.2 | 13.25-13.4       |
| 6.31175-6.31225   | 123-138             | 2200-2300     | 14.47-14.5       |
| 8.291-8.294       | 149.9-150.05        | 2310-2390     | 15.35-16.2       |
| 8.362-8.366       | 156.52475-156.52525 | 2483.5-2500   | 17.7-21.4        |
| 8.37625-8.38675   | 156.7-156.9         | 2690-2900     | 22.01-23.12      |
| 8.41425-8.41475   | 162.0125-167.17     | 3260-3267     | 23.6-24.0        |
| 12.29-12.293      | 167.72-173.2        | 3332-3339     | 31.2-31.8        |
| 12.51975-12.52025 | 240-285             | 3345.8-3358   | 36.43-36.5       |
| 12.57675-12.57725 | 322-335.4           | 3600-4400     | ( <sup>2</sup> ) |
| 13.36-13.41       |                     |               |                  |

## 8.2.2 FCC 15.209 Limit.

| FREQUENCY<br>MHz | DISTANCE<br>Meters | FIELD STRENGTHS LIMIT   |                                   |
|------------------|--------------------|---|-----------------------------------|
|                  |                    | $\mu\text{V}/\text{m}$  | $\text{dB}(\mu\text{V})/\text{m}$ |
| 0.009 ~ 0.490    | 300                | 2400/F(kHz)   | 67.6-20log(F)                     |
| 0.490 ~ 1.705    | 30                 | 24000/F(kHz)  | 87.6-20log(F)                     |
| 1.705 ~ 30.0     | 30                 | 30  | 29.54                             |
| 30 ~ 88          | 3                  | 100   | 40.0                              |
| 88 ~ 216         | 3                  | 150   | 43.5                              |
| 216 ~ 960        | 3                  | 200   | 46.0                              |
| 960 ~ 1000       | 3                  | 500   | 54.0                              |
| Above 1000       | 3                  | 74.0 $\text{dB}(\mu\text{V})/\text{m}$ (Peak)<br>54.0 $\text{dB}(\mu\text{V})/\text{m}$ (Average) |                                   |

Note: (1) The emission limits shown in the above table are based on measurements employing a CISPR QP detector except for the frequency bands 9-90kHz, 110-490kHz and above 1000MHz. Radiated emissions limits in these three bands are based on measurements employing an average detector.

(2) At frequencies below 30MHz, measurement may be performed at a distance closer than that specified, and the limit at closer measurement distance can be extrapolated by below formula:

$$\text{Limit}_{3\text{m}}(\text{dB}\mu\text{V}/\text{m}) = \text{Limit}_{30\text{m}}(\text{dB}\mu\text{V}/\text{m}) + 40\text{Log}(30\text{m}/3\text{m})$$

## 8.2.3 Limit for this EUT

All the emissions appearing within 15.205 restricted frequency bands shall not exceed the limits shown in 15.209, all the other emissions shall be at least 20dB below the fundamental emissions or comply with 15.209 limits.

## 8.3. Test Procedure

(1) EUT height should be 0.8m for below 1GHz at a semi - anechoic chamber while EUT height should be 1.5m for above 1GHz at full chamber or semi - anechoic chamber ground with absorbers.

(2) The antenna used as below table.

| Test frequency range | Test antenna used                      | Measuring distance |
|----------------------|--|--------------------|
| 9kHz-30MHz           | Active Loop antenna                    | 3 m                |
| 30MHz-1GHz           | Trilog Broadband Antenna               | 3 m                |
| 1GHz-18GHz           | Double Ridged Horn Antenna(1GHz-18GHz) | 3 m                |
| 18GHz-40GHz          | Horn Antenna(18GHz-40GHz)              | 1 m                |

According ANSI C63.10:2013 clause 6.4.4.2 and 6.5.3, for measurements below 30 MHz, the loop antenna was positioned with its plane vertical from the EUT and rotated about its vertical axis for maximum response at each azimuth position around the EUT. And the loop antenna also be positioned with its plane horizontal at the specified distance from the EUT. The center of the loop is 1 m above the ground. for measurement above 30MHz, the Trilog Broadband Antenna or Horn Antenna was located 3m from EUT, Measurements were made with the antenna positioned in both the horizontal and vertical planes of Polarization, and the measurement antenna was varied from 1 m to 4 m. in height above the

reference ground plane to obtain the maximum signal strength.

(3) Below pre-scan procedure was first performed in order to find prominent frequency spectrum radiated emissions from 9kHz to 25GHz:

(a) Scanning the peak frequency spectrum with the antenna specified in step (3), and the EUT was rotated 360 degree, the antenna height was varied from 1m to 4m (Except loop antenna, it's fixed 1m above ground.)

(b) Change work frequency or channel of device if practicable.

(c) Change modulation type of device if practicable.

(d) Change power supply range from 85% to 115% of the rated supply voltage

(e) Rotated EUT though three orthogonal axes to determine the attitude of EUT arrangement produces highest emissions.

Spectrum frequency from 9kHz to 25GHz (tenth harmonic of fundamental frequency) was investigated, and no any obvious emission were detected from 18GHz to 25GHz, so below final test was performed with frequency range from 9kHz to 18GHz.

(4) For final emissions measurements at each frequency of interest, the EUT was rotated and the antenna height was varied between 1m and 4m in order to maximize the emission. Measurements in both horizontal and vertical polarities were made and the data was recorded. In order to find the maximum emission, the relative positions of equipment and all of the interface cables were changed according to ANSI C63.10 2013 on Radiated Emission test.

(5) The emissions from 9kHz to 1GHz were measured based on CISPR QP detector except for the frequency bands 9-90kHz, 110-490kHz, for emissions from 9kHz-90kHz,110kHz-490kHz and above 1GHz were measured based on average detector, for emissions above 1GHz, peak emissions also be measured and need comply with Peak limit.

(6) The emissions from 9kHz to 1GHz, QP or average values were measured with EMI receiver with below RBW

| Frequency band | RBW    |
|----------------|--------|
| 9kHz-150kHz    | 200Hz  |
| 150kHz-30MHz   | 9kHz   |
| 30MHz-1GHz     | 120kHz |

(7) For emissions above 1GHz, both Peak and Average level were measured with Spectrum Analyzer, and the RBW is set at 1MHz, VBW is set at 3MHz for Peak measure; RMS detector RBW 1MHz VBW 10Hz for Average measure (according ANSI C63.10:2013 clause 4.2.3.2.3 procedure for average measure).

#### 8.4. Test result

**PASS. (See below detailed test result)**

All the emissions except fundamental emission from 9kHz to 25GHz were comply with 15.209 limit.

Note1: According exploratory test no any obvious emission was detected from 9kHz to 30MHz and 18GHz to 25GHz, so the final test was performed with frequency range from 30MHz to 18GHz and recorded in below.

Note2: For emissions below 1GHz, according exploratory explorer test, when change Tx mode and channel, have no distinct influence on emissions level, so for emissions below 1GHz, the final test was only performed with EUT working in 11g, Tx CH11 mode.



**Radiated Emission test (below 1GHz)**

**TR-4-E-009 Radiated Emission Test Result**

|                     |  |   |
|---------------------|--|---|
| <b>Test Site</b>    | : DDT 3m Chamber 1#                          | D:\2018 RE1# Report Data\Q18101003-1E WALL AP\RF        |
|                     |  | 30M-1G.EM6  |
| <b>Test Date</b>    | : 2018-10-22                                 | <b>Tested By</b> : Talent                               |
| <b>EUT</b>          | : Wall AP                                    | <b>Model Number</b> : WL8200-WH2                        |
| <b>Power Supply</b> | : DC 48V                                     | <b>Test Mode</b> : Tx mode                              |
| <b>Condition</b>    | : Temp:24.5'C, Humi:55.5%,<br>Press:100.1kPa | <b>Antenna/Distance</b> : 2017 VULB 9163 1#/3m/VERTICAL |

**Memo** :

Data: 57

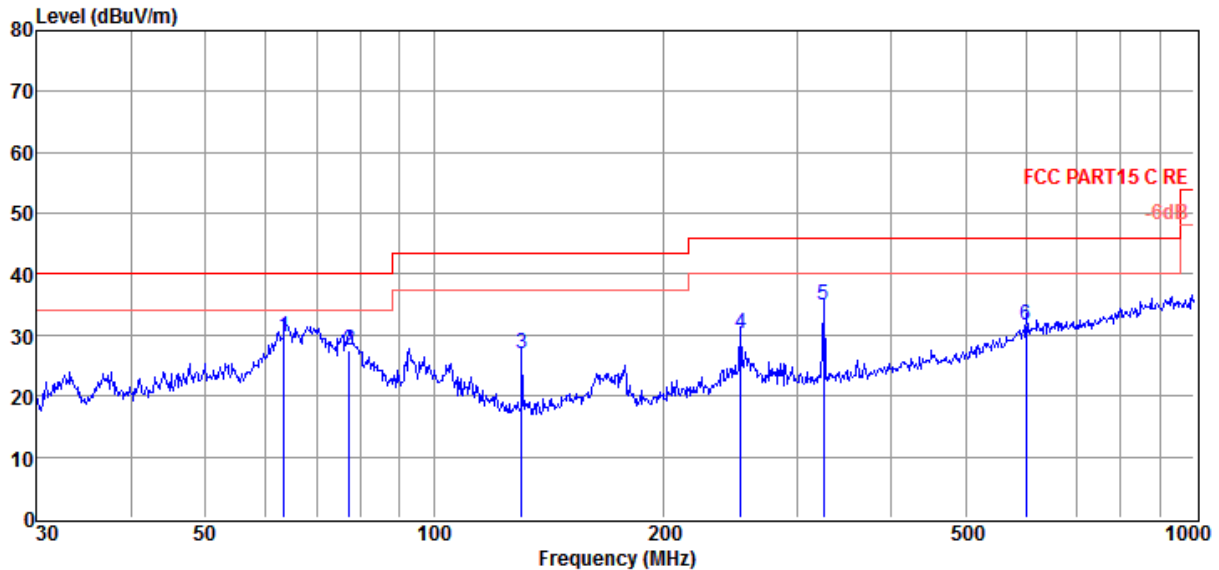

| Item (Mark) | Freq. (MHz) | Read Level (dBuV) | Antenna Factor (dB/m) | Cable Loss (dB) | Result Level (dBuV/m) | Limit Line (dBuV/m) | Over Limit (dB) | Detector | Polarization |
|-------------|-------------|-------------------|-----------------------|-----------------|-----------------------|---------------------|-----------------|----------|--------------|
| 1           | 63.54       | 15.01             | 10.58                 | 4.12            | 29.71                 | 40.00               | -10.29          | QP       | VERTICAL     |
| 2           | 77.32       | 15.31             | 8.01                  | 4.23            | 27.55                 | 40.00               | -12.45          | QP       | VERTICAL     |
| 3           | 130.38      | 14.14             | 8.23                  | 4.64            | 27.01                 | 43.50               | -16.49          | QP       | VERTICAL     |
| 4           | 252.95      | 12.52             | 12.54                 | 5.31            | 30.37                 | 46.00               | -15.63          | QP       | VERTICAL     |
| 5           | 325.60      | 15.46             | 13.84                 | 5.64            | 34.94                 | 46.00               | -11.06          | QP       | VERTICAL     |
| 6           | 601.43      | 5.43              | 19.40                 | 6.68            | 31.51                 | 46.00               | -14.49          | QP       | VERTICAL     |

Note: 1. Result Level = Read Level + Antenna Factor + Cable loss.  
 2. If Peak Result complies with QP limit, QP Result is deemed to comply with QP limit.  
 3. Test setup: RBW: 120 kHz, VBW: 300 kHz, Sweep time: auto.

# TR-4-E-009 Radiated Emission Test Result

**Test Site** : DDT 3m Chamber 1# D:\2018 RE1# Report Data\Q18101003-1E WALL AP\RF 30M-1G.EM6  
**Test Date** : 2018-10-22 **Tested By** : Talent  
**EUT** : Wall AP **Model Number** : WL8200-WH2  
**Power Supply** : DC 48V **Test Mode** : Tx mode  
**Condition** : Temp:24.5°C, Humi:55.5%,  
 Press:100.1kPa **Antenna/Distance** : 2017 VULB 9163 1#/3m/HORIZONTAL  
**Memo** :

Data: 58

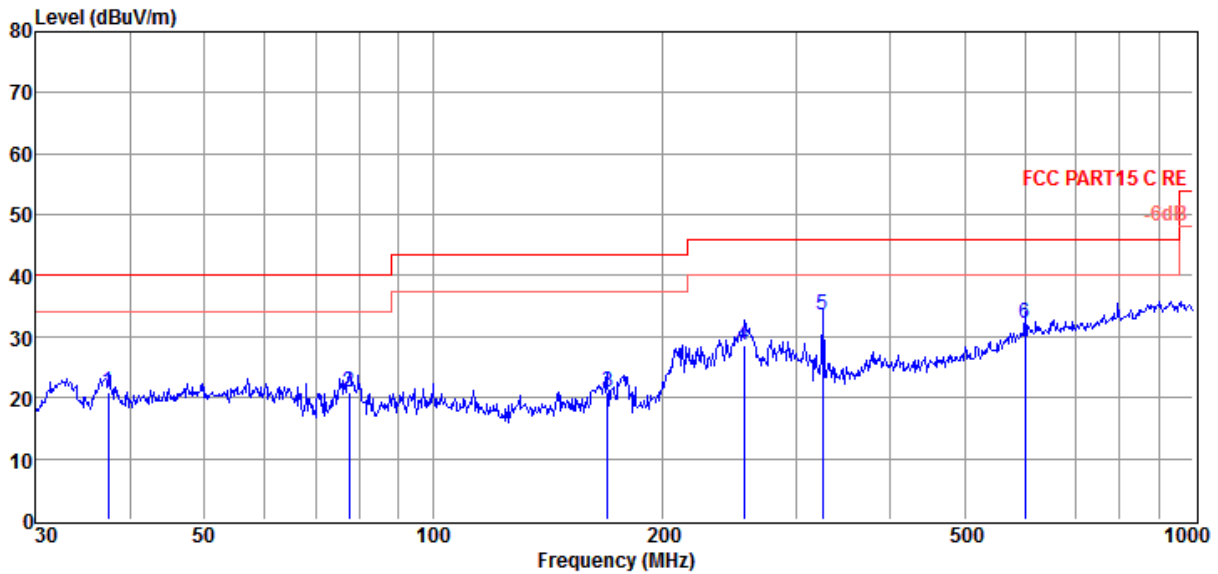

| Item (Mark) | Freq. (MHz) | Read Level (dBμV) | Antenna Factor (dB/m) | Cable Loss (dB) | Result Level (dBμV/m) | Limit Line (dBμV/m) | Over Limit (dB) | Detector | Polarization |
|-------------|-------------|-------------------|-----------------------|-----------------|-----------------------|---------------------|-----------------|----------|--------------|
| 1           | 37.42       | 5.09              | 12.09                 | 3.85            | 21.03                 | 40.00               | -18.97          | QP       | HORIZONTAL   |
| 2           | 77.59       | 8.78              | 7.97                  | 4.23            | 20.98                 | 40.00               | -19.02          | QP       | HORIZONTAL   |
| 3           | 169.60      | 6.79              | 9.14                  | 4.87            | 20.80                 | 43.50               | -22.70          | QP       | HORIZONTAL   |
| 4           | 256.52      | 10.80             | 12.60                 | 5.33            | 28.73                 | 46.00               | -17.27          | QP       | HORIZONTAL   |
| 5           | 325.60      | 14.02             | 13.84                 | 5.64            | 33.50                 | 46.00               | -12.50          | QP       | HORIZONTAL   |
| 6           | 601.43      | 6.04              | 19.40                 | 6.68            | 32.12                 | 46.00               | -13.88          | QP       | HORIZONTAL   |

Note: 1. Result Level = Read Level + Antenna Factor + Cable loss.  
 2. If Peak Result complies with QP limit, QP Result is deemed to comply with QP limit.  
 3. Test setup: RBW: 120 kHz, VBW: 300 kHz, Sweep time: auto.

**Radiated Emission test (above 1GHz)**

| Freq (MHz)      | Read level (dBμV) | Antenna Factor (dB/m) | PRM Factor(dB) | Cable Loss (dB) | Result Level (dBμV/m) | Limit (dBμV/m) | Margin (dB) | Detector type | Polarization |
|-----------------|-------------------|-----------------------|----------------|-----------------|-----------------------|----------------|-------------|---------------|--------------|
| <b>11g CH1</b>  |                   |                       |                |                 |                       |                |             |               |              |
| 5998.00         | 48.51             | 35.70                 | 43.20          | 8.21            | 49.22                 | 74.00          | -24.78      | Peak          | HORIZONTAL   |
| 7409.00         | 48.35             | 36.96                 | 43.62          | 8.70            | 50.39                 | 74.00          | -23.61      | Peak          | HORIZONTAL   |
| 8310.00         | 47.52             | 37.26                 | 43.89          | 9.58            | 50.47                 | 74.00          | -23.53      | Peak          | HORIZONTAL   |
| 9483.00         | 49.04             | 37.69                 | 44.24          | 10.62           | 53.11                 | 74.00          | -20.89      | Peak          | HORIZONTAL   |
| 12152.00        | 46.47             | 38.87                 | 44.14          | 11.03           | 52.23                 | 74.00          | -21.77      | Peak          | HORIZONTAL   |
| 12730.00        | 46.98             | 39.03                 | 44.28          | 11.25           | 52.98                 | 74.00          | -21.02      | Peak          | HORIZONTAL   |
| 4825.00         | 51.04             | 34.72                 | 43.91          | 7.40            | 49.25                 | 74.00          | -24.75      | Peak          | VERTICAL     |
| 6083.00         | 47.77             | 35.70                 | 43.22          | 8.22            | 48.47                 | 74.00          | -25.53      | Peak          | VERTICAL     |
| 7358.00         | 48.34             | 36.94                 | 43.61          | 8.65            | 50.32                 | 74.00          | -23.68      | Peak          | VERTICAL     |
| 8446.00         | 47.61             | 37.29                 | 43.93          | 9.74            | 50.71                 | 74.00          | -23.29      | Peak          | VERTICAL     |
| 9449.00         | 47.84             | 37.68                 | 44.23          | 10.60           | 51.89                 | 74.00          | -22.11      | Peak          | VERTICAL     |
| 12475.00        | 46.99             | 38.81                 | 44.22          | 11.15           | 52.73                 | 74.00          | -21.27      | Peak          | VERTICAL     |
| <b>11g CH6</b>  |                   |                       |                |                 |                       |                |             |               |              |
| 5301.00         | 48.62             | 35.30                 | 43.62          | 7.77            | 48.07                 | 74.00          | -25.93      | Peak          | HORIZONTAL   |
| 6678.00         | 47.46             | 36.09                 | 43.40          | 8.29            | 48.44                 | 74.00          | -25.56      | Peak          | HORIZONTAL   |
| 7817.00         | 47.09             | 37.13                 | 43.75          | 9.07            | 49.54                 | 74.00          | -24.46      | Peak          | HORIZONTAL   |
| 8939.00         | 48.34             | 37.48                 | 44.08          | 10.30           | 52.04                 | 74.00          | -21.96      | Peak          | HORIZONTAL   |
| 9466.00         | 47.76             | 37.69                 | 44.24          | 10.61           | 51.82                 | 74.00          | -22.18      | Peak          | HORIZONTAL   |
| 12679.00        | 46.78             | 38.98                 | 44.27          | 11.23           | 52.72                 | 74.00          | -21.28      | Peak          | HORIZONTAL   |
| 4876.00         | 51.60             | 34.80                 | 43.87          | 7.46            | 49.99                 | 74.00          | -24.01      | Peak          | VERTICAL     |
| 6916.00         | 47.99             | 36.62                 | 43.47          | 8.32            | 49.46                 | 74.00          | -24.54      | Peak          | VERTICAL     |
| 8412.00         | 47.46             | 37.28                 | 43.92          | 9.70            | 50.52                 | 74.00          | -23.48      | Peak          | VERTICAL     |
| 9670.00         | 47.21             | 37.87                 | 44.30          | 10.72           | 51.50                 | 74.00          | -22.50      | Peak          | VERTICAL     |
| 11863.00        | 46.12             | 38.82                 | 44.12          | 10.98           | 51.80                 | 74.00          | -22.20      | Peak          | VERTICAL     |
| 12781.00        | 46.95             | 39.08                 | 44.30          | 11.27           | 53.00                 | 74.00          | -21.00      | Peak          | VERTICAL     |
| <b>11g CH11</b> |                   |                       |                |                 |                       |                |             |               |              |
| 5641.00         | 49.33             | 35.56                 | 43.42          | 7.98            | 49.45                 | 74.00          | -24.55      | Peak          | HORIZONTAL   |
| 7001.00         | 47.78             | 36.80                 | 43.50          | 8.33            | 49.41                 | 74.00          | -24.59      | Peak          | HORIZONTAL   |
| 8446.00         | 48.55             | 37.29                 | 43.93          | 9.74            | 51.65                 | 74.00          | -22.35      | Peak          | HORIZONTAL   |
| 9636.00         | 47.59             | 37.84                 | 44.29          | 10.70           | 51.84                 | 74.00          | -22.16      | Peak          | HORIZONTAL   |
| 12118.00        | 46.30             | 38.88                 | 44.13          | 11.01           | 52.06                 | 74.00          | -21.94      | Peak          | HORIZONTAL   |
| 12662.00        | 46.22             | 38.96                 | 44.27          | 11.22           | 52.13                 | 74.00          | -21.87      | Peak          | HORIZONTAL   |
| 5556.00         | 48.73             | 35.52                 | 43.47          | 7.93            | 48.71                 | 74.00          | -25.29      | Peak          | VERTICAL     |
| 6882.00         | 48.94             | 36.54                 | 43.46          | 8.32            | 50.34                 | 74.00          | -23.66      | Peak          | VERTICAL     |
| 8310.00         | 46.86             | 37.26                 | 43.89          | 9.58            | 49.81                 | 74.00          | -24.19      | Peak          | VERTICAL     |
| 9602.00         | 47.88             | 37.80                 | 44.28          | 10.68           | 52.08                 | 74.00          | -21.92      | Peak          | VERTICAL     |
| 12152.00        | 47.48             | 38.87                 | 44.14          | 11.03           | 53.24                 | 74.00          | -20.76      | Peak          | VERTICAL     |
| 12679.00        | 46.69             | 38.98                 | 44.27          | 11.23           | 52.63                 | 74.00          | -21.37      | Peak          | VERTICAL     |

Note: 1.30MHz~25GHz: (Scan with 11b mode, 11g mode, 11n HT20 mode ANT 1 and ANT 2, 11n HT40 mode ANT 1 and ANT 2, the worst case is 11g mode)

2. Result Level = Read Level + Antenna Factor + Cable loss - PRM Factor.

3. Test setup: RBW: 1 MHz, VBW: 3 MHz, Sweep time: auto.

4. For emissions above 1GHz. If peak results comply with AV limit, AV Result is deemed to comply with AV limit.

## 9. Radiated Band Edge Compliance

### 9.1. Block diagram of test setup

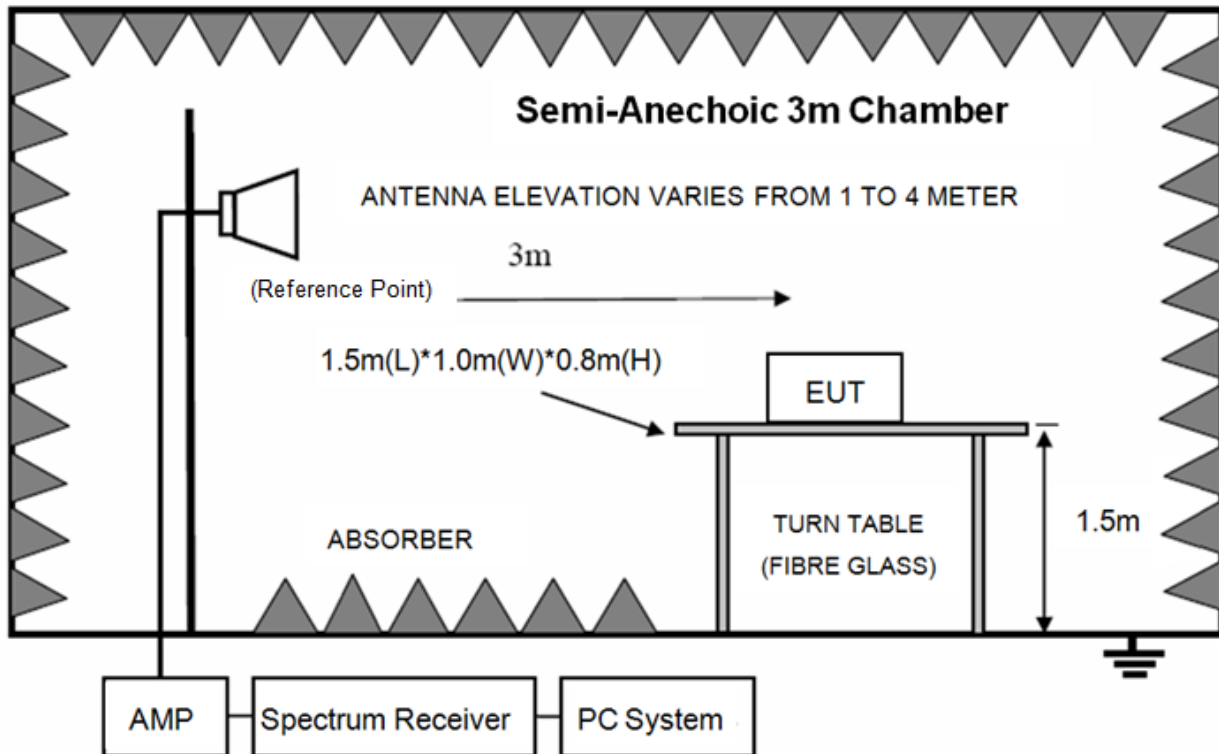

### 9.2. Limit

All restricted frequency bands shall not exceed the limits shown in 15.209, all the other emissions outside operation frequency band 2400MHz to 2483.5MHz shall be at least 20dB below the fundamental emissions or comply with RSS-Gen Issue 3 clause 7.2.5 (Same as FCC 15.209) limits.

### 9.3. Test Procedure

Same with clause 8.3 except change investigated frequency range from 2310MHz to 2430MHz and 2445MHz to 2500MHz.

Remark: All restriction band have been tested, and only the worst case is shown in report.

### 9.4. Test result

#### **PASS. (See below detailed test result)**

Note: 11b, 11g, n20, n40 mode ANT 1 and ANT 2 mode all have been tested, only Ant 1 mode is worse case and reported.

# TR-4-E-009 Radiated Emission Test Result

**Test Site** : DDT 3m Chamber 1# D:\2018 RE1# Report Data\Q18101003-1E WALL AP\RF ABOVE1G.EM6  
**Test Date** : 2018-10-22 **Tested By** : Talent  
**EUT** : Wall AP **Model Number** : WL8200-WH2  
**Power Supply** : DC 48V **Test Mode** : Tx mode  
**Condition** : Temp:24.5'C, Humi:55.5%,  
 Press:100.1kPa **Antenna/Distance** : 2017 HF907/3m/VERTICAL  
**Memo** : 11b 2412MHz

Data: 53

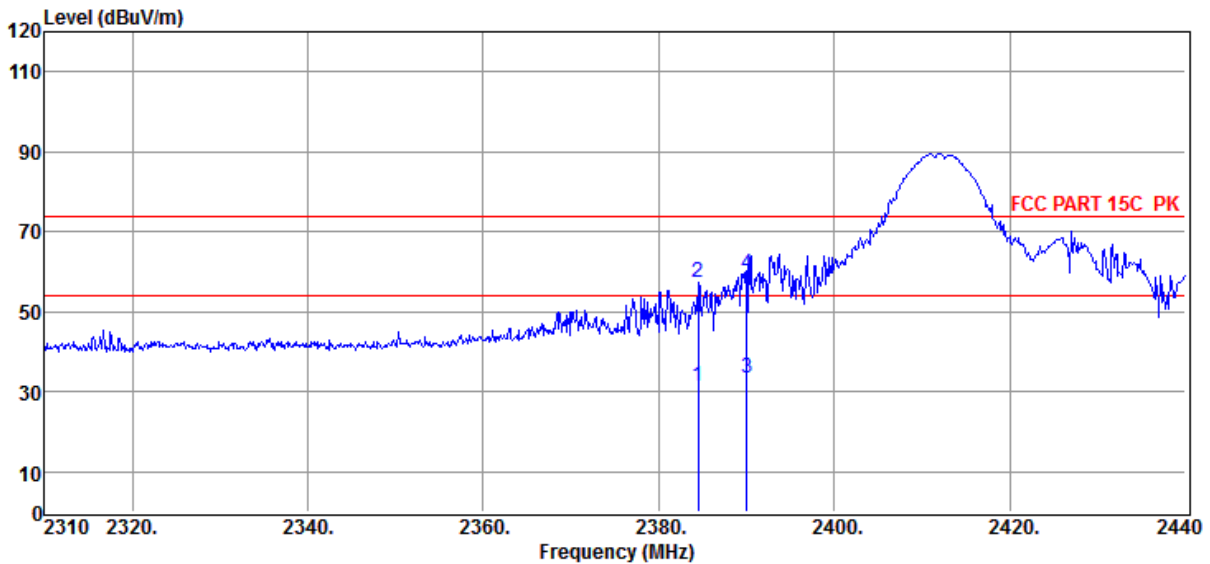

| Item<br>(Mark) | Freq.<br>(MHz) | Read<br>Level<br>(dBμV) | Antenna<br>Factor<br>(dB/m) | PRM<br>Factor<br>dB | Cable<br>Loss<br>dB | Result<br>Level<br>(dBμV/m) | Limit<br>Line<br>(dBμV/m) | Over<br>Limit<br>(dB) | Detector | Polarization |
|----------------|----------------|-------------------------|-----------------------------|---------------------|---------------------|-----------------------------|---------------------------|-----------------------|----------|--------------|
| 1              | 2384.49        | 43.74                   | 26.98                       | 44.32               | 5.10                | 31.50                       | 54.00                     | -22.50                | Average  | VERTICAL     |
| 2              | 2384.49        | 69.71                   | 26.98                       | 44.32               | 5.10                | 57.47                       | 74.00                     | -16.53                | Peak     | VERTICAL     |
| 3              | 2390.00        | 45.67                   | 27.00                       | 44.32               | 5.11                | 33.46                       | 54.00                     | -20.54                | Average  | VERTICAL     |
| 4              | 2390.00        | 71.69                   | 27.00                       | 44.32               | 5.11                | 59.48                       | 74.00                     | -14.52                | Peak     | VERTICAL     |

- Note: 1. Result Level = Read Level + Antenna Factor + Cable loss - PRM Factor.  
 2. If Peak Result complies with AV limit, AV Result is deemed to comply with AV limit.  
 3. Test setup: RBW: 1 MHz, VBW: 3 MHz, Sweep time: auto.

# TR-4-E-009 Radiated Emission Test Result

**Test Site** : DDT 3m Chamber 1# D:\2018 RE1# Report Data\Q18101003-1E WALL AP\RF ABOVE1G.EM6  
**Test Date** : 2018-10-22 **Tested By** : Talent  
**EUT** : Wall AP **Model Number** : WL8200-WH2  
**Power Supply** : DC 48V **Test Mode** : Tx mode  
**Condition** : Temp:24.5'C, Humi:55.5%,  
 Press:100.1kPa **Antenna/Distance** : 2017 HF907/3m/HORIZONTAL  
**Memo** : 11b 2412MHz

Data: 54

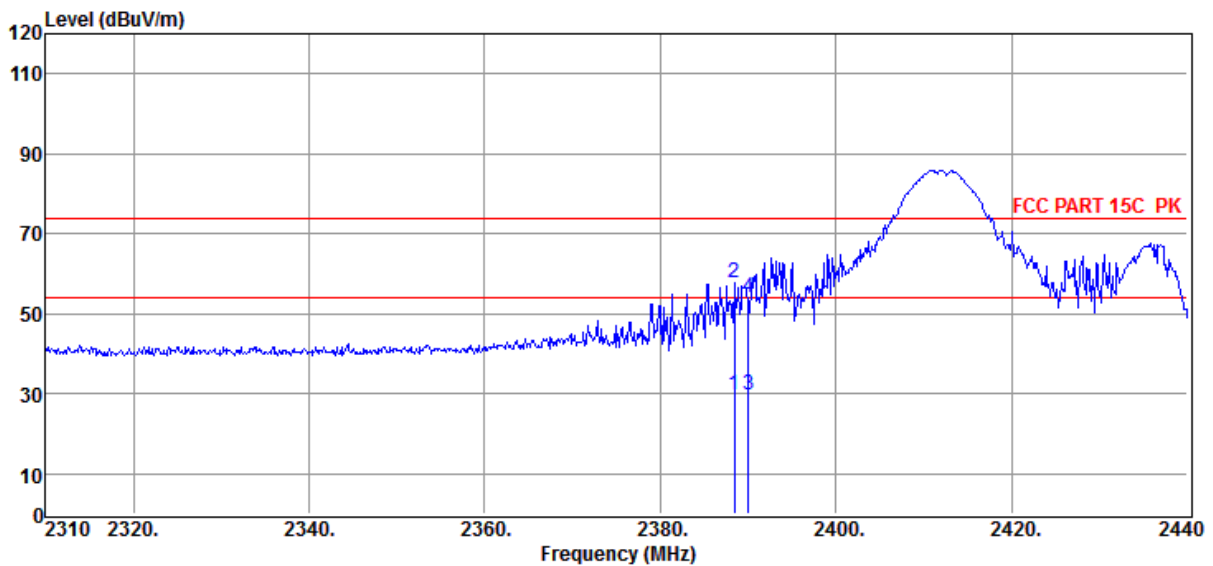

| Item<br>(Mark) | Freq.<br>(MHz) | Read<br>Level<br>(dBμV) | Antenna<br>Factor<br>(dB/m) | PRM<br>Factor<br>dB | Cable<br>Loss<br>dB | Result<br>Level<br>(dBμV/m<br>) | Limit<br>Line<br>(dBμV/<br>m) | Over<br>Limit<br>(dB) | Detector | Polarization |
|----------------|----------------|-------------------------|-----------------------------|---------------------|---------------------|---------------------------------|-------------------------------|-----------------------|----------|--------------|
| 1              | 2388.39        | 41.90                   | 27.00                       | 44.32               | 5.11                | 29.69                           | 54.00                         | -24.31                | Average  | HORIZONTAL   |
| 2              | 2388.39        | 69.98                   | 27.00                       | 44.32               | 5.11                | 57.77                           | 74.00                         | -16.23                | Peak     | HORIZONTAL   |
| 3              | 2390.00        | 41.88                   | 27.00                       | 44.32               | 5.11                | 29.67                           | 54.00                         | -24.33                | Average  | HORIZONTAL   |
| 4              | 2390.00        | 66.18                   | 27.00                       | 44.32               | 5.11                | 53.97                           | 74.00                         | -20.03                | Peak     | HORIZONTAL   |

- Note: 1. Result Level = Read Level + Antenna Factor + Cable loss - PRM Factor.  
 2. If Peak Result complies with AV limit, AV Result is deemed to comply with AV limit.  
 3. Test setup: RBW: 1 MHz, VBW: 3 MHz, Sweep time: auto.

# TR-4-E-009 Radiated Emission Test Result

|                     |  |  |
|---------------------|--|--|
| <b>Test Site</b>    | : DDT 3m Chamber 1#                          | D:\2018 RE1# Report Data\Q18101003-1E WALL AP\RF ABOVE1G.EM6 |
| <b>Test Date</b>    | : 2018-10-22                                 | <b>Tested By</b> : Talent                                    |
| <b>EUT</b>          | : Wall AP                                    | <b>Model Number</b> : WL8200-WH2                             |
| <b>Power Supply</b> | : DC 48V                                     | <b>Test Mode</b> : Tx mode                                   |
| <b>Condition</b>    | : Temp:24.5'C, Humi:55.5%,<br>Press:100.1kPa | <b>Antenna/Distance</b> : 2017 HF907/3m/HORIZONTAL           |
| <b>Memo</b>         | : 11B 2462MHz                                |  |

Data: 55

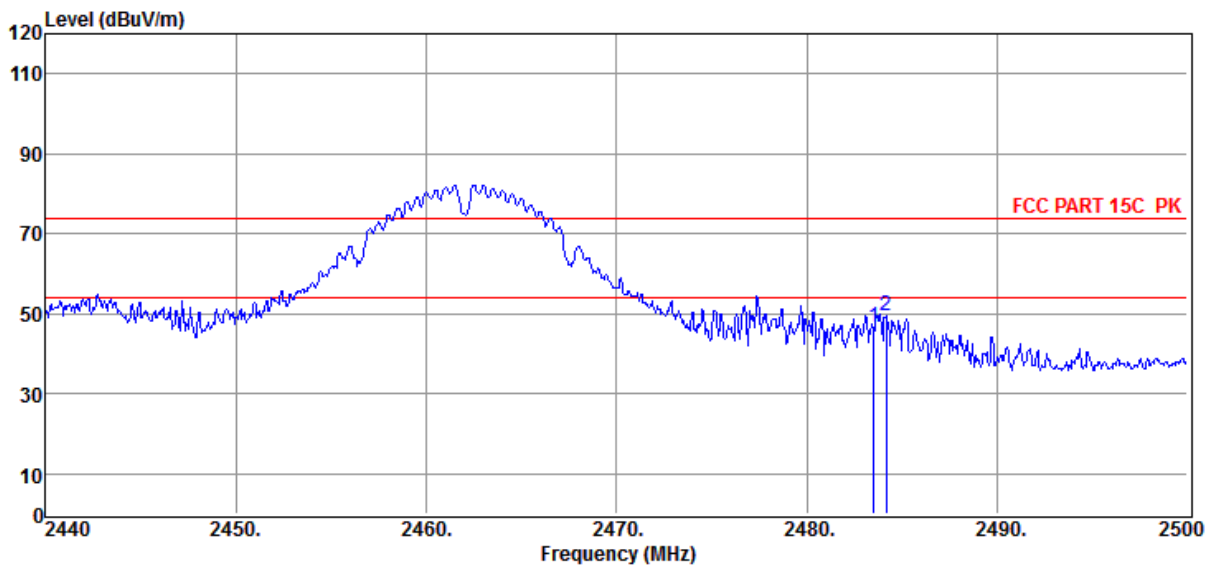

| Item<br>(Mark) | Freq.<br>(MHz) | Read Level<br>(dBμV) | Antenna Factor<br>(dB/m) | PRM Factor<br>dB | Cable Loss<br>dB | Result Level<br>(dBμV/m) | Limit Line<br>(dBμV/m) | Over Limit<br>(dB) | Detector | Polarization |
|----------------|----------------|----------------------|--------------------------|------------------|------------------|--------------------------|------------------------|--------------------|----------|--------------|
| 1              | 2483.50        | 58.31                | 27.34                    | 44.32            | 5.21             | 46.54                    | 74.00                  | -27.46             | Peak     | HORIZONTAL   |
| 2              | 2484.16        | 61.42                | 27.34                    | 44.32            | 5.21             | 49.65                    | 74.00                  | -24.35             | Peak     | HORIZONTAL   |

- Note: 1. Result Level = Read Level + Antenna Factor + Cable loss - PRM Factor.  
 2. If Peak Result complies with AV limit, AV Result is deemed to comply with AV limit.  
 3. Test setup: RBW: 1 MHz, VBW: 3 MHz, Sweep time: auto.

# TR-4-E-009 Radiated Emission Test Result

**Test Site** : DDT 3m Chamber 1# D:\2018 RE1# Report Data\Q18101003-1E WALL AP\RF ABOVE1G.EM6  
**Test Date** : 2018-10-22 **Tested By** : Talent  
**EUT** : Wall AP **Model Number** : WL8200-WH2  
**Power Supply** : DC 48V **Test Mode** : Tx mode  
**Condition** : Temp:24.5'C, Humi:55.5%,  
 Press:100.1kPa **Antenna/Distance** : 2017 HF907/3m/VERTICAL  
**Memo** : 11B 2462MHz

Data: 56

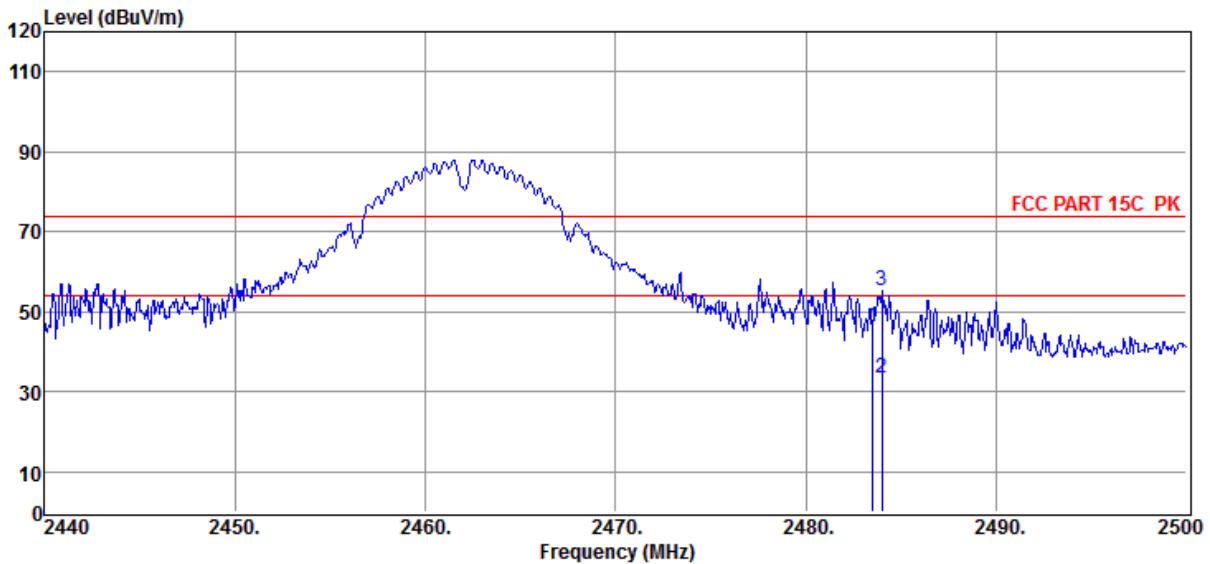

| Item<br>(Mark) | Freq.<br>(MHz) | Read<br>Level<br>(dBμV) | Antenna<br>Factor<br>(dB/m) | PRM<br>Factor<br>dB | Cable<br>Loss<br>dB | Result<br>Level<br>(dBμV/m) | Limit<br>Line<br>(dBμV/m) | Over<br>Limit<br>(dB) | Detector | Polarization |
|----------------|----------------|-------------------------|-----------------------------|---------------------|---------------------|-----------------------------|---------------------------|-----------------------|----------|--------------|
| 1              | 2483.50        | 58.13                   | 27.34                       | 44.32               | 5.21                | 46.36                       | 74.00                     | -27.64                | Peak     | VERTICAL     |
| 2              | 2483.98        | 45.00                   | 27.34                       | 44.32               | 5.21                | 33.23                       | 54.00                     | -20.77                | Average  | VERTICAL     |
| 3              | 2483.98        | 67.06                   | 27.34                       | 44.32               | 5.21                | 55.29                       | 74.00                     | -18.71                | Peak     | VERTICAL     |

- Note: 1. Result Level = Read Level + Antenna Factor + Cable loss - PRM Factor.  
 2. If Peak Result complies with AV limit, AV Result is deemed to comply with AV limit.  
 3. Test setup: RBW: 1 MHz, VBW: 3 MHz, Sweep time: auto.



# TR-4-E-009 Radiated Emission Test Result

|                     |  |  |
|---------------------|--|--|
| <b>Test Site</b>    | : DDT 3m Chamber 1#                          | D:\2018 RE1# Report Data\Q18101003-1E WALL AP\RF ABOVE1G.EM6 |
| <b>Test Date</b>    | : 2018-10-22                                 | <b>Tested By</b> : Talent                                    |
| <b>EUT</b>          | : Wall AP                                    | <b>Model Number</b> : WL8200-WH2                             |
| <b>Power Supply</b> | : DC 48V                                     | <b>Test Mode</b> : Tx mode                                   |
| <b>Condition</b>    | : Temp:24.5'C, Humi:55.5%,<br>Press:100.1kPa | <b>Antenna/Distance</b> : 2017 HF907/3m/VERTICAL             |
| <b>Memo</b>         | : 11G 2412MHz                                |  |

Data: 57

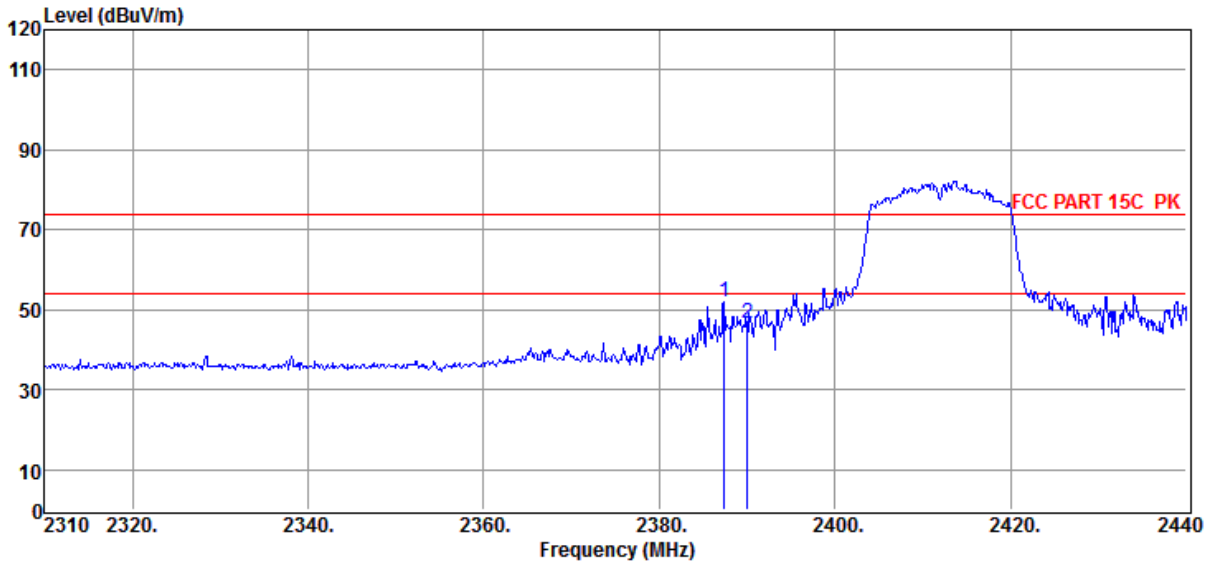

| Item (Mark) | Freq. (MHz) | Read Level (dBμV) | Antenna Factor (dB/m) | PRM Factor (dB) | Cable Loss (dB) | Result Level (dBμV/m) | Limit Line (dBμV/m) | Over Limit (dB) | Detector | Polarization |
|-------------|-------------|-------------------|-----------------------|-----------------|-----------------|-----------------------|---------------------|-----------------|----------|--------------|
| 1           | 2387.35     | 64.05             | 26.99                 | 44.32           | 5.11            | 51.83                 | 74.00               | -22.17          | Peak     | VERTICAL     |
| 2           | 2390.00     | 58.75             | 27.00                 | 44.32           | 5.11            | 46.54                 | 74.00               | -27.46          | Peak     | VERTICAL     |

Note: 1. Result Level = Read Level + Antenna Factor + Cable loss - PRM Factor.  
 2. If Peak Result complies with AV limit, AV Result is deemed to comply with AV limit.  
 3. Test setup: RBW: 1 MHz, VBW: 3 MHz, Sweep time: auto.

# TR-4-E-009 Radiated Emission Test Result

|                     |  |  |
|---------------------|--|--|
| <b>Test Site</b>    | : DDT 3m Chamber 1#                          | D:\2018 RE1# Report Data\Q18101003-1E WALL AP\RF ABOVE1G.EM6 |
| <b>Test Date</b>    | : 2018-10-22                                 | <b>Tested By</b> : Talent                                    |
| <b>EUT</b>          | : Wall AP                                    | <b>Model Number</b> : WL8200-WH2                             |
| <b>Power Supply</b> | : DC 48V                                     | <b>Test Mode</b> : Tx mode                                   |
| <b>Condition</b>    | : Temp:24.5'C, Humi:55.5%,<br>Press:100.1kPa | <b>Antenna/Distance</b> : 2017 HF907/3m/HORIZONTAL           |
| <b>Memo</b>         | : 11G 2412MHz                                |  |

Data: 58

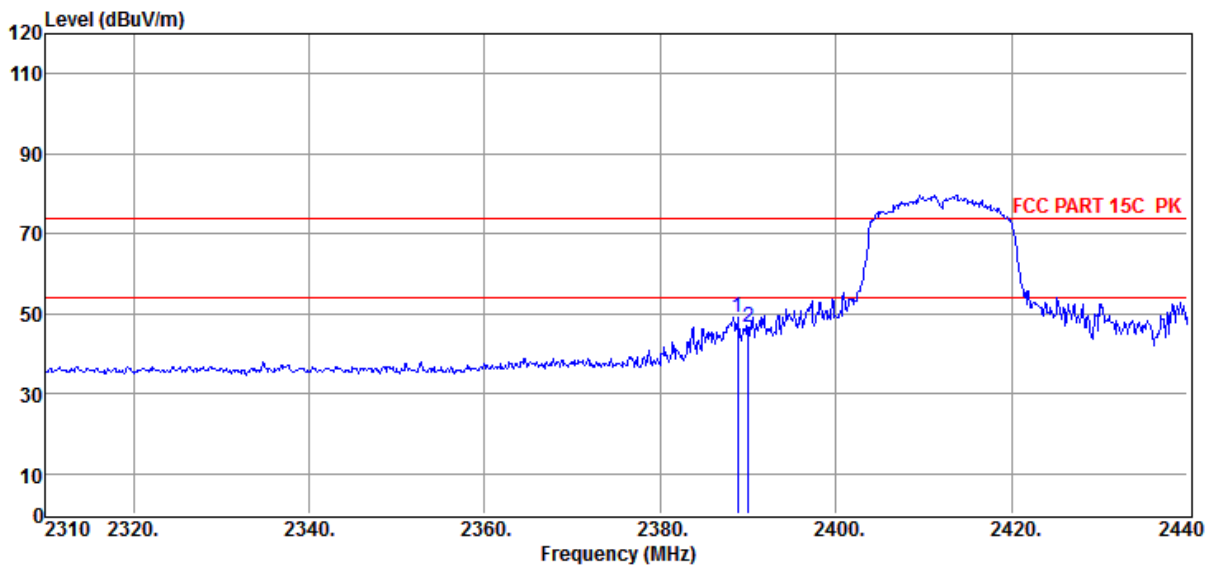

| Item (Mark) | Freq. (MHz) | Read Level (dBμV) | Antenna Factor (dB/m) | PRM Factor (dB) | Cable Loss (dB) | Result Level (dBμV/m) | Limit Line (dBμV/m) | Over Limit (dB) | Detector | Polarization |
|-------------|-------------|-------------------|-----------------------|-----------------|-----------------|-----------------------|---------------------|-----------------|----------|--------------|
| 1           | 2388.78     | 61.29             | 27.00                 | 44.32           | 5.11            | 49.08                 | 74.00               | -24.92          | Peak     | HORIZONTAL   |
| 2           | 2390.00     | 58.88             | 27.00                 | 44.32           | 5.11            | 46.67                 | 74.00               | -27.33          | Peak     | HORIZONTAL   |

- Note: 1. Result Level = Read Level + Antenna Factor + Cable loss - PRM Factor.  
 2. If Peak Result complies with AV limit, AV Result is deemed to comply with AV limit.  
 3. Test setup: RBW: 1 MHz, VBW: 3 MHz, Sweep time: auto.

# TR-4-E-009 Radiated Emission Test Result

|                     |  |  |
|---------------------|--|--|
| <b>Test Site</b>    | : DDT 3m Chamber 1#                          | D:\2018 RE1# Report Data\Q18101003-1E WALL AP\RF ABOVE1G.EM6 |
| <b>Test Date</b>    | : 2018-10-22                                 | <b>Tested By</b> : Talent                                    |
| <b>EUT</b>          | : Wall AP                                    | <b>Model Number</b> : WL8200-WH2                             |
| <b>Power Supply</b> | : DC 48V                                     | <b>Test Mode</b> : Tx mode                                   |
| <b>Condition</b>    | : Temp:24.5'C, Humi:55.5%,<br>Press:100.1kPa | <b>Antenna/Distance</b> : 2017 HF907/3m/HORIZONTAL           |
| <b>Memo</b>         | : 11G 2462MHz                                |  |

Data: 59

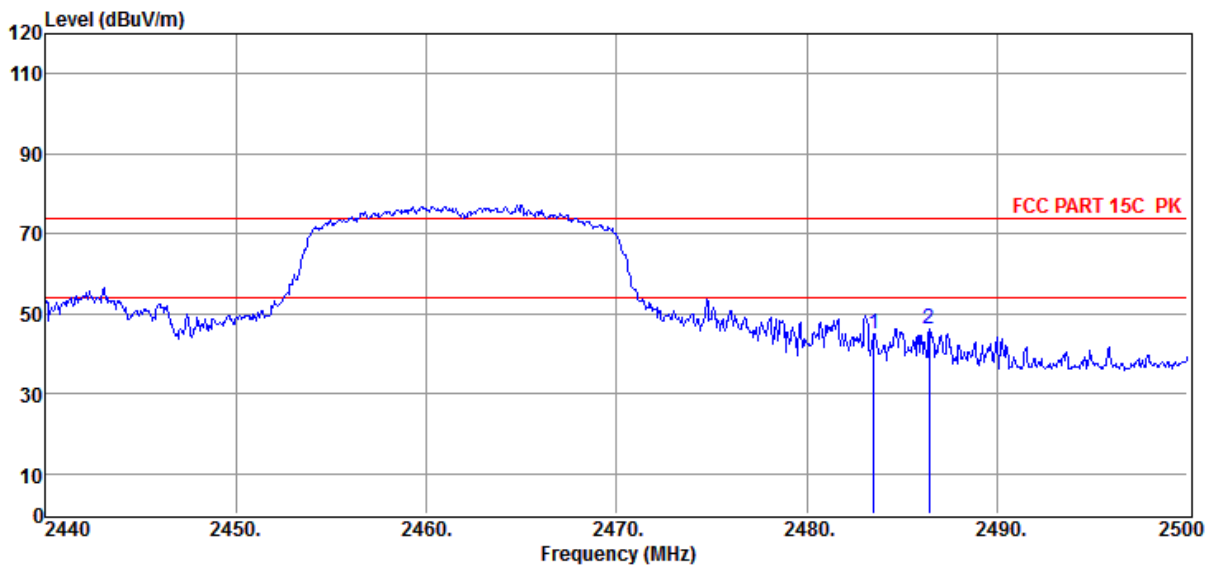

| Item<br>(Mark) | Freq.<br>(MHz) | Read Level<br>(dBμV) | Antenna Factor<br>(dB/m) | PRM Factor<br>dB | Cable Loss<br>dB | Result Level<br>(dBμV/m) | Limit Line<br>(dBμV/m) | Over Limit<br>(dB) | Detector | Polarization |
|----------------|----------------|----------------------|--------------------------|------------------|------------------|--------------------------|------------------------|--------------------|----------|--------------|
| 1              | 2483.50        | 56.80                | 27.34                    | 44.32            | 5.21             | 45.03                    | 74.00                  | -28.97             | Peak     | HORIZONTAL   |
| 2              | 2486.44        | 57.99                | 27.35                    | 44.32            | 5.22             | 46.24                    | 74.00                  | -27.76             | Peak     | HORIZONTAL   |

Note: 1. Result Level = Read Level + Antenna Factor + Cable loss - PRM Factor.  
 2. If Peak Result complies with AV limit, AV Result is deemed to comply with AV limit.  
 3. Test setup: RBW: 1 MHz, VBW: 3 MHz, Sweep time: auto.

# TR-4-E-009 Radiated Emission Test Result

|                     |  |                         |  |
|---------------------|--|-------------------------|--|
| <b>Test Site</b>    | : DDT 3m Chamber 1#                          |                         | D:\2018 RE1# Report Data\Q18101003-1E WALL AP\RF ABOVE1G.EM6 |
| <b>Test Date</b>    | : 2018-10-22                                 | <b>Tested By</b>        | : Talent   |
| <b>EUT</b>          | : Wall AP                                    | <b>Model Number</b>     | : WL8200-WH2   |
| <b>Power Supply</b> | : DC 48V                                     | <b>Test Mode</b>        | : Tx mode  |
| <b>Condition</b>    | : Temp:24.5'C, Humi:55.5%,<br>Press:100.1kPa | <b>Antenna/Distance</b> | : 2017 HF907/3m/VERTICAL                                     |
| <b>Memo</b>         | : 11G 2462MHz                                |                         |  |

Data: 60

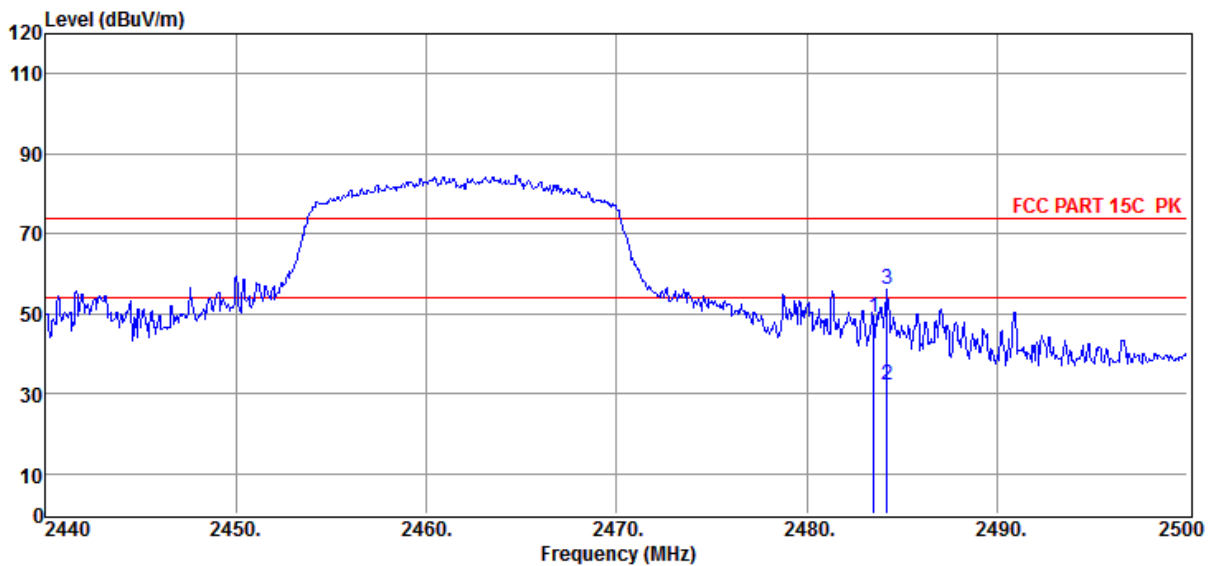

| Item (Mark) | Freq. (MHz) | Read Level (dBμV) | Antenna Factor (dB/m) | PRM Factor (dB) | Cable Loss (dB) | Result Level (dBμV/m) | Limit Line (dBμV/m) | Over Limit (dB) | Detector | Polarization |
|-------------|-------------|-------------------|-----------------------|-----------------|-----------------|-----------------------|---------------------|-----------------|----------|--------------|
| 1           | 2483.50     | 60.69             | 27.34                 | 44.32           | 5.21            | 48.92                 | 74.00               | -25.08          | Peak     | VERTICAL     |
| 2           | 2484.22     | 44.00             | 27.34                 | 44.32           | 5.21            | 32.23                 | 54.00               | -21.77          | Average  | VERTICAL     |
| 3           | 2484.22     | 67.80             | 27.34                 | 44.32           | 5.21            | 56.03                 | 74.00               | -17.97          | Peak     | VERTICAL     |

- Note: 1. Result Level = Read Level + Antenna Factor + Cable loss - PRM Factor.  
 2. If Peak Result complies with AV limit, AV Result is deemed to comply with AV limit.  
 3. Test setup: RBW: 1 MHz, VBW: 3 MHz, Sweep time: auto.

# TR-4-E-009 Radiated Emission Test Result

|                     |  |  |
|---------------------|--|--|
| <b>Test Site</b>    | : DDT 3m Chamber 1#                          | D:\2018 RE1# Report Data\Q18101003-1E WALL AP\RF ABOVE1G.EM6 |
| <b>Test Date</b>    | : 2018-10-22                                 | <b>Tested By</b> : Talent                                    |
| <b>EUT</b>          | : Wall AP                                    | <b>Model Number</b> : WL8200-WH2                             |
| <b>Power Supply</b> | : DC 48V                                     | <b>Test Mode</b> : Tx mode                                   |
| <b>Condition</b>    | : Temp:24.5'C, Humi:55.5%,<br>Press:100.1kPa | <b>Antenna/Distance</b> : 2017 HF907/3m/VERTICAL             |
| <b>Memo</b>         | : 11N20 2412MHz                              |  |

Data: 61

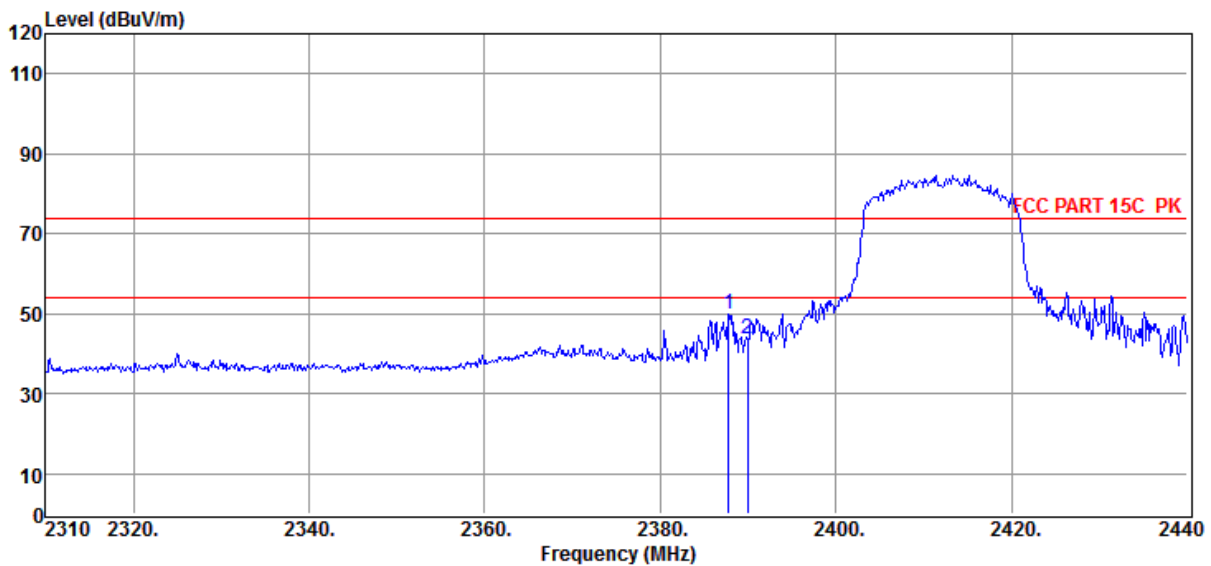

| Item<br>(Mark) | Freq.<br>(MHz) | Read<br>Level<br>(dBμV) | Antenna<br>Factor<br>(dB/m) | PRM<br>Factor<br>dB | Cable<br>Loss<br>dB | Result<br>Level<br>(dBμV/m) | Limit<br>Line<br>(dBμV/m) | Over<br>Limit<br>(dB) | Detector | Polarization |
|----------------|----------------|-------------------------|-----------------------------|---------------------|---------------------|-----------------------------|---------------------------|-----------------------|----------|--------------|
| 1              | 2387.74        | 62.15                   | 27.00                       | 44.32               | 5.11                | 49.94                       | 74.00                     | -24.06                | Peak     | VERTICAL     |
| 2              | 2390           | 56.05                   | 27.00                       | 44.32               | 5.11                | 43.84                       | 74.00                     | -30.16                | Peak     | VERTICAL     |

- Note: 1. Result Level = Read Level + Antenna Factor + Cable loss - PRM Factor.  
 2. If Peak Result complies with AV limit, AV Result is deemed to comply with AV limit.  
 3. Test setup: RBW: 1 MHz, VBW: 3 MHz, Sweep time: auto.

# TR-4-E-009 Radiated Emission Test Result

|                     |  |  |
|---------------------|--|--|
| <b>Test Site</b>    | : DDT 3m Chamber 1#                          | D:\2018 RE1# Report Data\Q18101003-1E WALL AP\RF ABOVE1G.EM6 |
| <b>Test Date</b>    | : 2018-10-22                                 | <b>Tested By</b> : Talent                                    |
| <b>EUT</b>          | : Wall AP                                    | <b>Model Number</b> : WL8200-WH2                             |
| <b>Power Supply</b> | : DC 48V                                     | <b>Test Mode</b> : Tx mode                                   |
| <b>Condition</b>    | : Temp:24.5'C, Humi:55.5%,<br>Press:100.1kPa | <b>Antenna/Distance</b> : 2017 HF907/3m/HORIZONTAL           |
| <b>Memo</b>         | : 11N20 2412MHz                              |  |

Data: 62

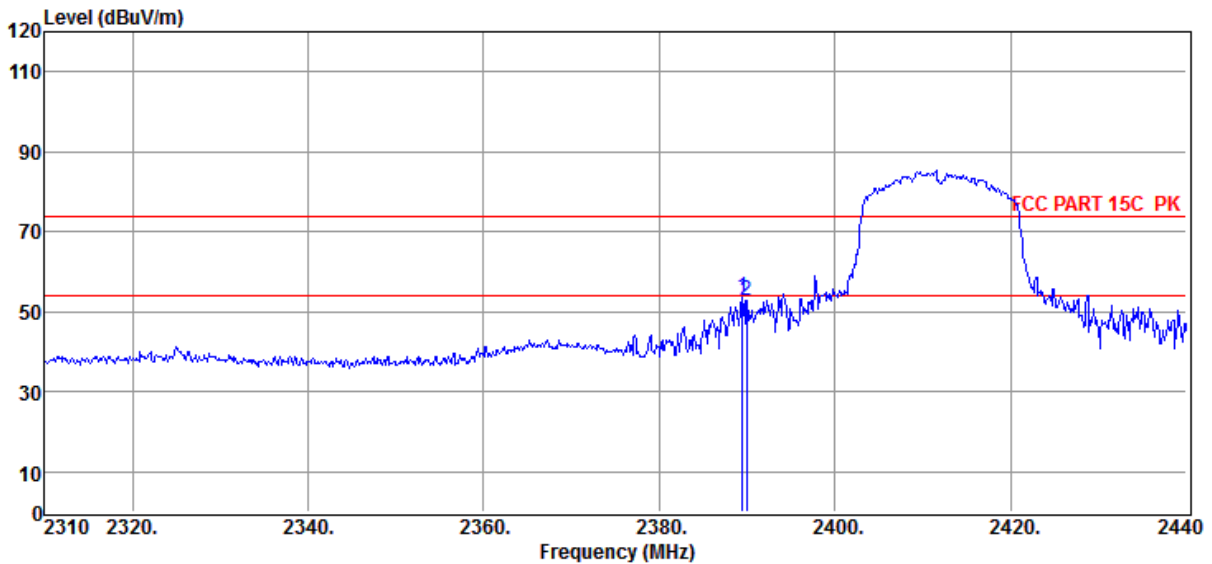

| Item (Mark) | Freq. (MHz) | Read Level (dBμV) | Antenna Factor (dB/m) | PRM Factor (dB) | Cable Loss (dB) | Result Level (dBμV/m) | Limit Line (dBμV/m) | Over Limit (dB) | Detector | Polarization |
|-------------|-------------|-------------------|-----------------------|-----------------|-----------------|-----------------------|---------------------|-----------------|----------|--------------|
| 1           | 2389.43     | 65.70             | 27.00                 | 44.32           | 5.11            | 53.49                 | 74.00               | -20.51          | Peak     | HORIZONTAL   |
| 2           | 2390        | 65.03             | 27.00                 | 44.32           | 5.11            | 52.82                 | 74.00               | -21.18          | Peak     | HORIZONTAL   |

- Note: 1. Result Level = Read Level + Antenna Factor + Cable loss - PRM Factor.  
 2. If Peak Result complies with AV limit, AV Result is deemed to comply with AV limit.  
 3. Test setup: RBW: 1 MHz, VBW: 3 MHz, Sweep time: auto.

# TR-4-E-009 Radiated Emission Test Result

|                     |  |  |
|---------------------|--|--|
| <b>Test Site</b>    | : DDT 3m Chamber 1#                          | D:\2018 RE1# Report Data\Q18101003-1E WALL AP\RF ABOVE1G.EM6 |
| <b>Test Date</b>    | : 2018-10-22                                 | <b>Tested By</b> : Talent                                    |
| <b>EUT</b>          | : Wall AP                                    | <b>Model Number</b> : WL8200-WH2                             |
| <b>Power Supply</b> | : DC 48V                                     | <b>Test Mode</b> : Tx mode                                   |
| <b>Condition</b>    | : Temp:24.5'C, Humi:55.5%,<br>Press:100.1kPa | <b>Antenna/Distance</b> : 2017 HF907/3m/HORIZONTAL           |
| <b>Memo</b>         | : 11N20 2462MHz                              |  |

Data: 63

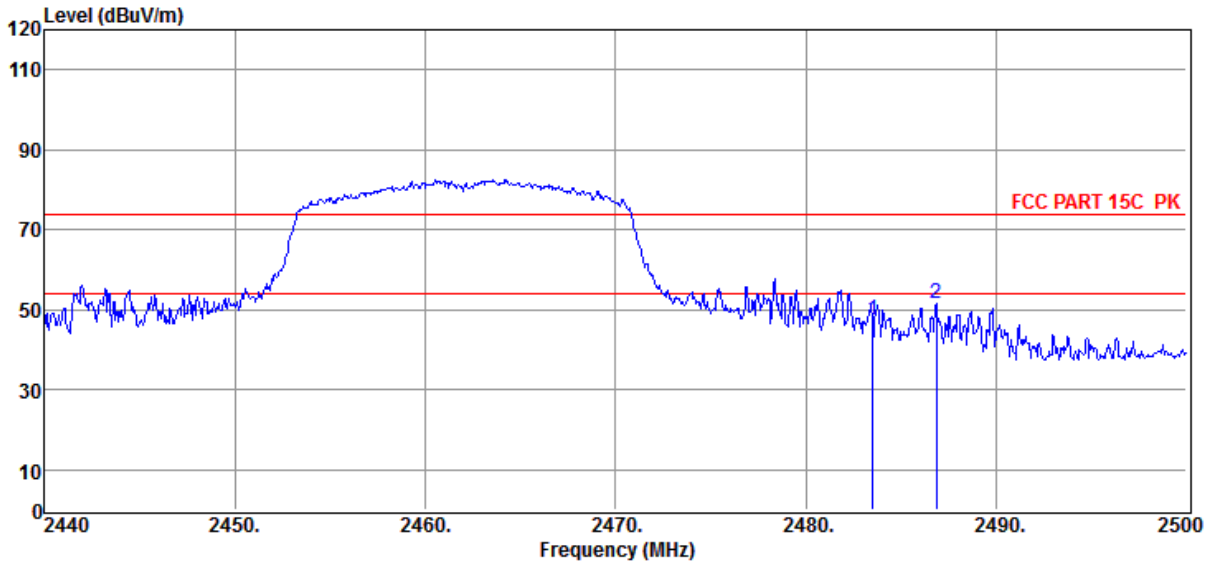

| Item<br>(Mark) | Freq.<br>(MHz) | Read Level<br>(dBμV) | Antenna Factor<br>(dB/m) | PRM Factor<br>dB | Cable Loss<br>dB | Result Level<br>(dBμV/m) | Limit Line<br>(dBμV/m) | Over Limit<br>(dB) | Detector | Polarization |
|----------------|----------------|----------------------|--------------------------|------------------|------------------|--------------------------|------------------------|--------------------|----------|--------------|
| 1              | 2483.50        | 59.08                | 27.34                    | 44.32            | 5.21             | 47.31                    | 74.00                  | -26.69             | Peak     | HORIZONTAL   |
| 2              | 2486.86        | 63.47                | 27.35                    | 44.32            | 5.22             | 51.72                    | 74.00                  | -22.28             | Peak     | HORIZONTAL   |

Note: 1. Result Level = Read Level + Antenna Factor + Cable loss - PRM Factor.  
 2. If Peak Result complies with AV limit, AV Result is deemed to comply with AV limit.  
 3. Test setup: RBW: 1 MHz, VBW: 3 MHz, Sweep time: auto.

# TR-4-E-009 Radiated Emission Test Result

|                     |  |  |
|---------------------|--|--|
| <b>Test Site</b>    | : DDT 3m Chamber 1#                          | D:\2018 RE1# Report Data\Q18101003-1E WALL AP\RF ABOVE1G.EM6 |
| <b>Test Date</b>    | : 2018-10-22                                 | <b>Tested By</b> : Talent                                    |
| <b>EUT</b>          | : Wall AP                                    | <b>Model Number</b> : WL8200-WH2                             |
| <b>Power Supply</b> | : DC 48V                                     | <b>Test Mode</b> : Tx mode                                   |
| <b>Condition</b>    | : Temp:24.5'C, Humi:55.5%,<br>Press:100.1kPa | <b>Antenna/Distance</b> : 2017 HF907/3m/VERTICAL             |
| <b>Memo</b>         | : 11N20 2462MHz                              |  |

Data: 64

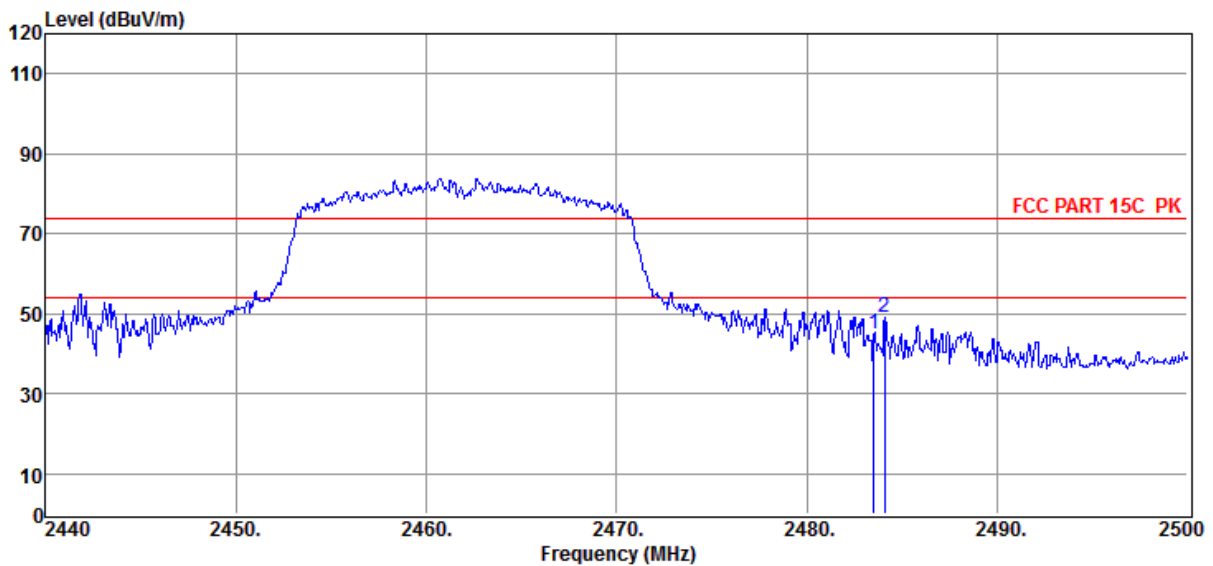

| Item (Mark) | Freq. (MHz) | Read Level (dBμV) | Antenna Factor (dB/m) | PRM Factor (dB) | Cable Loss (dB) | Result Level (dBμV/m) | Limit Line (dBμV/m) | Over Limit (dB) | Detector | Polarization |
|-------------|-------------|-------------------|-----------------------|-----------------|-----------------|-----------------------|---------------------|-----------------|----------|--------------|
| 1           | 2483.50     | 56.76             | 27.34                 | 44.32           | 5.21            | 44.99                 | 74.00               | -29.01          | Peak     | VERTICAL     |
| 2           | 2484.10     | 60.67             | 27.34                 | 44.32           | 5.21            | 48.90                 | 74.00               | -25.10          | Peak     | VERTICAL     |

Note: 1. Result Level = Read Level + Antenna Factor + Cable loss - PRM Factor.  
 2. If Peak Result complies with AV limit, AV Result is deemed to comply with AV limit.  
 3. Test setup: RBW: 1 MHz, VBW: 3 MHz, Sweep time: auto.



# TR-4-E-009 Radiated Emission Test Result

|                     |  |  |
|---------------------|--|--|
| <b>Test Site</b>    | : DDT 3m Chamber 1#                          | D:\2018 RE1# Report Data\Q18101003-1E WALL AP\RF ABOVE1G.EM6 |
| <b>Test Date</b>    | : 2018-10-23                                 | <b>Tested By</b> : Talent                                    |
| <b>EUT</b>          | : Wall AP                                    | <b>Model Number</b> : WL8200-WH2                             |
| <b>Power Supply</b> | : DC 48V                                     | <b>Test Mode</b> : Tx mode                                   |
| <b>Condition</b>    | : Temp:24.5'C, Humi:55.5%,<br>Press:100.1kPa | <b>Antenna/Distance</b> : 2017 HF907/3m/VERTICAL             |
| <b>Memo</b>         | : 11N40 2422MHz                              |  |

Data: 101

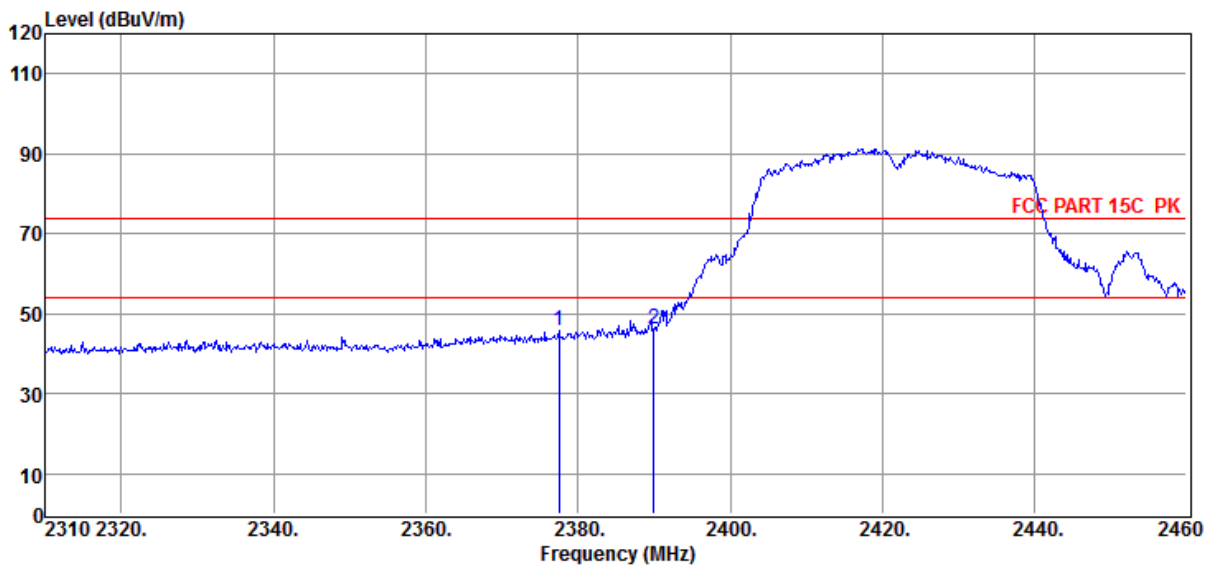

| Item (Mark) | Freq. (MHz) | Read Level (dBμV) | Antenna Factor (dB/m) | PRM Factor (dB) | Cable Loss (dB) | Result Level (dBμV/m) | Limit Line (dBμV/m) | Over Limit (dB) | Detector | Polarization |
|-------------|-------------|-------------------|-----------------------|-----------------|-----------------|-----------------------|---------------------|-----------------|----------|--------------|
| 1           | 2377.50     | 58.11             | 26.96                 | 44.32           | 5.10            | 45.85                 | 74.00               | -28.15          | Peak     | VERTICAL     |
| 2           | 2390.00     | 58.37             | 27.00                 | 44.32           | 5.11            | 46.16                 | 74.00               | -27.84          | Peak     | VERTICAL     |

Note: 1. Result Level = Read Level + Antenna Factor + Cable loss - PRM Factor.  
 2. If Peak Result complies with AV limit, AV Result is deemed to comply with AV limit.  
 3. Test setup: RBW: 1 MHz, VBW: 3 MHz, Sweep time: auto.

# TR-4-E-009 Radiated Emission Test Result

|                     |  |  |
|---------------------|--|--|
| <b>Test Site</b>    | : DDT 3m Chamber 1#                          | D:\2018 RE1# Report Data\Q18101003-1E WALL AP\RF ABOVE1G.EM6 |
| <b>Test Date</b>    | : 2018-10-23                                 | <b>Tested By</b> : Talent                                    |
| <b>EUT</b>          | : Wall AP                                    | <b>Model Number</b> : WL8200-WH2                             |
| <b>Power Supply</b> | : DC 48V                                     | <b>Test Mode</b> : Tx mode                                   |
| <b>Condition</b>    | : Temp:24.5'C, Humi:55.5%,<br>Press:100.1kPa | <b>Antenna/Distance</b> : 2017 HF907/3m/HORIZONTAL           |
| <b>Memo</b>         | : 11N40 2422MHz                              |  |

Data: 102

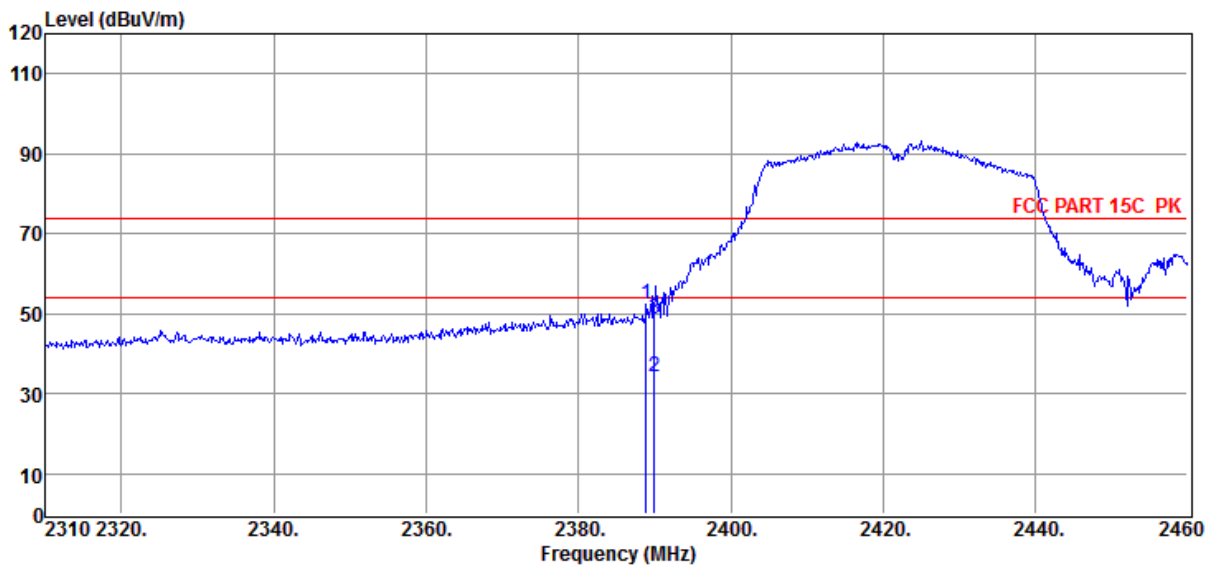

| Item (Mark) | Freq. (MHz) | Read Level (dBμV) | Antenna Factor (dB/m) | PRM Factor (dB) | Cable Loss (dB) | Result Level (dBμV/m) | Limit Line (dBμV/m) | Over Limit (dB) | Detector | Polarization |
|-------------|-------------|-------------------|-----------------------|-----------------|-----------------|-----------------------|---------------------|-----------------|----------|--------------|
| 1           | 2388.90     | 64.49             | 27.00                 | 44.32           | 5.11            | 52.28                 | 74.00               | -21.72          | Peak     | HORIZONTAL   |
| 2           | 2390.00     | 46.52             | 27.00                 | 44.32           | 5.11            | 34.31                 | 54.00               | -19.69          | Average  | HORIZONTAL   |
| 3           | 2390.00     | 61.05             | 27.00                 | 44.32           | 5.11            | 48.84                 | 74.00               | -25.16          | Peak     | HORIZONTAL   |

- Note: 1. Result Level = Read Level + Antenna Factor + Cable loss - PRM Factor.  
 2. If Peak Result complies with AV limit, AV Result is deemed to comply with AV limit.  
 3. Test setup: RBW: 1 MHz, VBW: 3 MHz, Sweep time: auto.

# TR-4-E-009 Radiated Emission Test Result

|                     |  |  |
|---------------------|--|--|
| <b>Test Site</b>    | : DDT 3m Chamber 1#                          | D:\2018 RE1# Report Data\Q18101003-1E WALL AP\RF ABOVE1G.EM6 |
| <b>Test Date</b>    | : 2018-10-23                                 | <b>Tested By</b> : Talent                                    |
| <b>EUT</b>          | : Wall AP                                    | <b>Model Number</b> : WL8200-WH2                             |
| <b>Power Supply</b> | : DC 48V                                     | <b>Test Mode</b> : Tx mode                                   |
| <b>Condition</b>    | : Temp:24.5'C, Humi:55.5%,<br>Press:100.1kPa | <b>Antenna/Distance</b> : 2017 HF907/3m/HORIZONTAL           |
| <b>Memo</b>         | : 11N40 2452MHz                              |  |

Data: 103

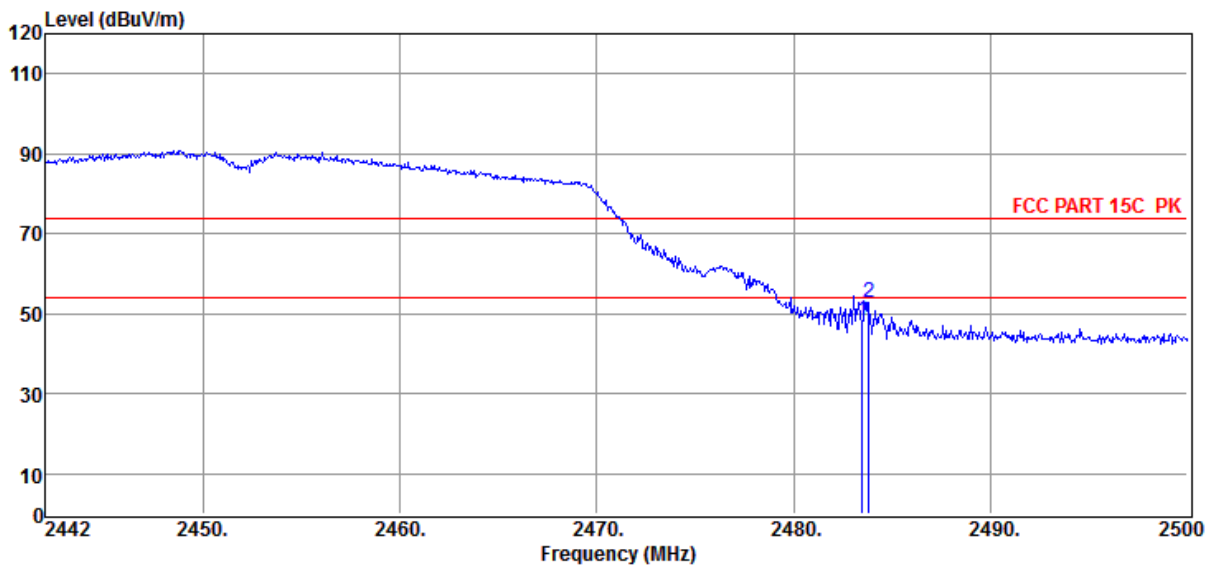

| Item (Mark) | Freq. (MHz) | Read Level (dBμV) | Antenna Factor (dB/m) | PRM Factor (dB) | Cable Loss (dB) | Result Level (dBμV/m) | Limit Line (dBμV/m) | Over Limit (dB) | Detector | Polarization |
|-------------|-------------|-------------------|-----------------------|-----------------|-----------------|-----------------------|---------------------|-----------------|----------|--------------|
| 1           | 2483.50     | 60.10             | 27.34                 | 44.32           | 5.21            | 48.33                 | 74.00               | -25.67          | Peak     | HORIZONTAL   |
| 2           | 2483.82     | 64.62             | 27.34                 | 44.32           | 5.21            | 52.85                 | 74.00               | -21.15          | Peak     | HORIZONTAL   |

Note: 1. Result Level = Read Level + Antenna Factor + Cable loss - PRM Factor.  
 2. If Peak Result complies with AV limit, AV Result is deemed to comply with AV limit.  
 3. Test setup: RBW: 1 MHz, VBW: 3 MHz, Sweep time: auto.

# TR-4-E-009 Radiated Emission Test Result

|                     |  |  |
|---------------------|--|--|
| <b>Test Site</b>    | : DDT 3m Chamber 1#                          | D:\2018 RE1# Report Data\Q18101003-1E WALL AP\RF ABOVE1G.EM6 |
| <b>Test Date</b>    | : 2018-10-23                                 | <b>Tested By</b> : Talent                                    |
| <b>EUT</b>          | : Wall AP                                    | <b>Model Number</b> : WL8200-WH2                             |
| <b>Power Supply</b> | : DC 48V                                     | <b>Test Mode</b> : Tx mode                                   |
| <b>Condition</b>    | : Temp:24.5'C, Humi:55.5%,<br>Press:100.1kPa | <b>Antenna/Distance</b> : 2017 HF907/3m/VERTICAL             |
| <b>Memo</b>         | : 11N40 2452MHz                              |  |

Data: 104

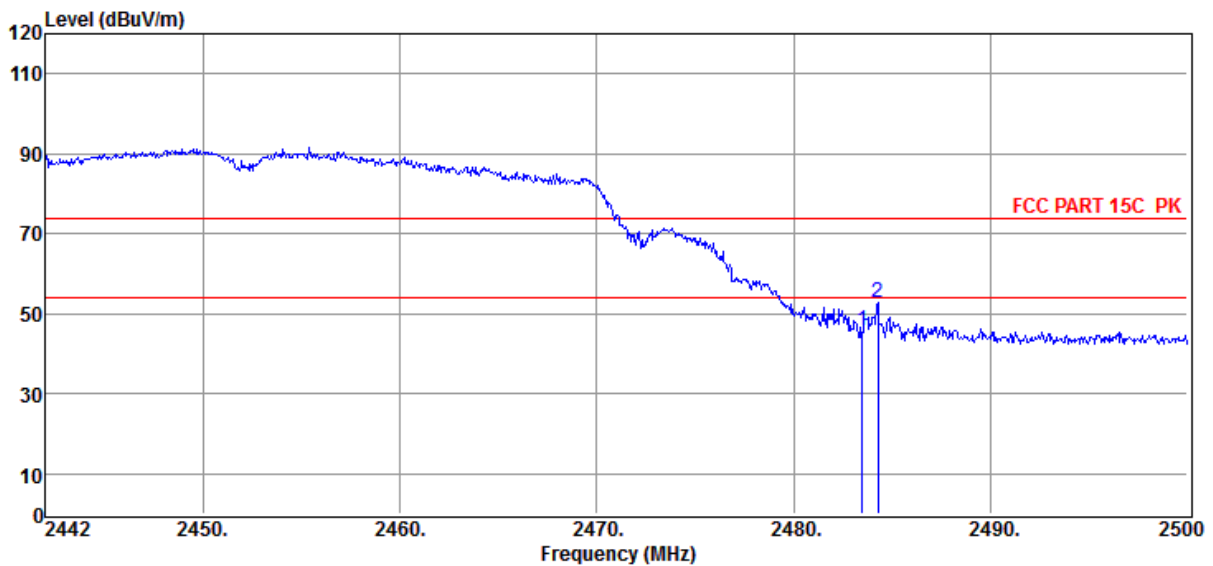

| Item (Mark) | Freq. (MHz) | Read Level (dBμV) | Antenna Factor (dB/m) | PRM Factor (dB) | Cable Loss (dB) | Result Level (dBμV/m) | Limit Line (dBμV/m) | Over Limit (dB) | Detector | Polarization |
|-------------|-------------|-------------------|-----------------------|-----------------|-----------------|-----------------------|---------------------|-----------------|----------|--------------|
| 1           | 2483.50     | 57.69             | 27.34                 | 44.32           | 5.21            | 45.92                 | 74.00               | -28.08          | Peak     | VERTICAL     |
| 2           | 2484.28     | 64.71             | 27.34                 | 44.32           | 5.21            | 52.94                 | 74.00               | -21.06          | Peak     | VERTICAL     |

Note: 1. Result Level = Read Level + Antenna Factor + Cable loss - PRM Factor.  
 2. If Peak Result complies with AV limit, AV Result is deemed to comply with AV limit.  
 3. Test setup: RBW: 1 MHz, VBW: 3 MHz, Sweep time: auto.

## 10. Power Line Conducted Emission

### 10.1. Block diagram of test setup

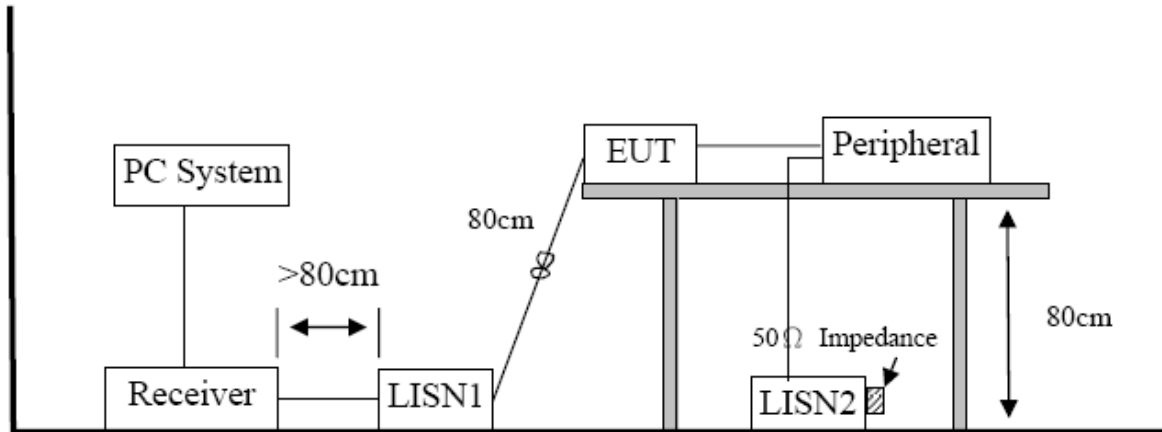

### 10.2. Power Line Conducted Emission Limits (Class B)

| Frequency       | Quasi-Peak Level<br>dB( $\mu$ V) | Average Level<br>dB( $\mu$ V) |
|-----------------|----------------------------------|-------------------------------|
| 150kHz ~ 500kHz | 66 ~ 56*                         | 56 ~ 46*                      |
| 500kHz ~ 5MHz   | 56                               | 46                            |
| 5MHz ~ 30MHz    | 60                               | 50                            |

Note 1: \* Decreasing linearly with logarithm of frequency.

Note 2: The lower limit shall apply at the transition frequencies.

### 10.3. Test Procedure

The EUT and Support equipment, if needed, were put placed on a non-metallic table, 80cm above the ground plane.

All I/O cables were positioned to simulate typical actual usage as per ANSI C63.4.

All support equipment power received from a second LISN.

Emissions were measured on each current carrying line of the EUT using an EMI Test Receiver connected to the LISN powering the EUT.

The Receiver scanned from 150 kHz to 30MHz for emissions in each of the test modes.

During the above scans, the emissions were maximized by cable manipulation.

After the preliminary scan, we found the test mode producing the highest emission level.

The EUT configuration and worse cable configuration of the above highest emission levels were recorded for reference of the final test.

EUT and support equipment were set up on the test bench as per the configuration with highest emission level in the preliminary test.

A scan was taken on both power lines, Neutral and Line, recording at least the six highest emissions.

Emission frequency and amplitude were recorded into a computer in which correction factors were used

to calculate the emission level and compare reading to the applicable limit.

The test data of the worst-case condition(s) was recorded.

The bandwidth of test receiver is set at 9 kHz.

#### **10.4. Test Result**

**PASS. (See below detailed test result)**

Note1: All emissions not reported below are too low against the prescribed limits.

Note2: “----” means Peak detection; “----” means Average detection.

Note3: Pre-test AC conducted emission at both voltage AC 120V/60Hz and AC 240V/60Hz, recorded worse case (AC 120V/60Hz).

# TR-4-E-010 Conducted Emission Test Result

**Test Site** : DDT 1# Shield Room D:\2018 CE report data\Q18101003-1E\CE.EM6  
**Test Date** : 2018-12-24 **Tested By** : Open  
**EUT** : Wall AP **Model Number** : WL8200-WH2  
**Power Supply** : DC 48V from AC Adapter **Test Mode** : Tx mode  
**Condition** : Temp:24.5°C,Humi:55%,Press:100.1kPa **LISN** : 2018 ENV216/NEUTRAL  
**Memo** :

Data: 40

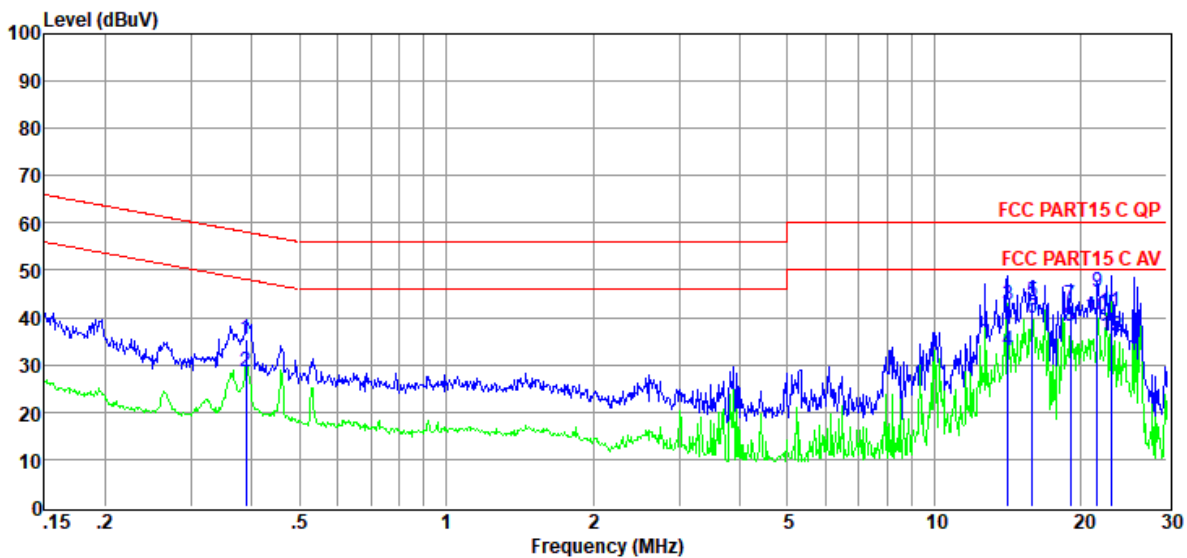

| Item<br>(Mark) | Freq.<br>(MHz) | Read Level<br>(dBμV) | LISN Factor<br>(dB) | Cable Loss<br>(dB) | Pulse Limiter Factor<br>(dB) | Result Level<br>(dBμV) | Limit Line<br>(dBμV) | Over Limit<br>(dB) | Detector | Phase   |
|----------------|----------------|----------------------|---------------------|--------------------|------------------------------|------------------------|----------------------|--------------------|----------|---------|
| 1              | 0.39           | 15.84                | 9.64                | 0.02               | 9.86                         | 35.36                  | 58.08                | -22.72             | QP       | NEUTRAL |
| 2              | 0.39           | 9.03                 | 9.64                | 0.02               | 9.86                         | 28.55                  | 48.08                | -19.53             | Average  | NEUTRAL |
| 3              | 14.14          | 22.20                | 10.25               | 0.06               | 9.93                         | 42.44                  | 60.00                | -17.56             | QP       | NEUTRAL |
| 4              | 14.14          | 12.87                | 10.25               | 0.06               | 9.93                         | 33.11                  | 50.00                | -16.89             | Average  | NEUTRAL |
| 5              | 15.89          | 23.24                | 10.25               | 0.05               | 9.93                         | 43.47                  | 60.00                | -16.53             | QP       | NEUTRAL |
| 6              | 15.89          | 19.54                | 10.25               | 0.05               | 9.93                         | 39.77                  | 50.00                | -10.23             | Average  | NEUTRAL |
| 7              | 19.02          | 22.68                | 10.03               | 0.07               | 9.95                         | 42.73                  | 60.00                | -17.27             | QP       | NEUTRAL |
| 8              | 19.02          | 18.06                | 10.03               | 0.07               | 9.95                         | 38.11                  | 50.00                | -11.89             | Average  | NEUTRAL |
| 9              | 21.60          | 25.25                | 10.02               | 0.08               | 9.96                         | 45.31                  | 60.00                | -14.69             | QP       | NEUTRAL |
| 10             | 21.60          | 20.30                | 10.02               | 0.08               | 9.96                         | 40.36                  | 50.00                | -9.64              | Average  | NEUTRAL |
| 11             | 23.02          | 20.96                | 10.06               | 0.09               | 9.97                         | 41.08                  | 60.00                | -18.92             | QP       | NEUTRAL |
| 12             | 23.02          | 15.84                | 10.06               | 0.09               | 9.97                         | 35.96                  | 50.00                | -14.04             | Average  | NEUTRAL |

- Note: 1. Result Level = Read Level + LISN Factor + Pulse Limiter Factor + Cable loss.  
 2. If QP Result complies with AV limit, AV Result is deemed to comply with AV limit.  
 3. Test setup: RBW: 200 Hz (9 kHz—150 kHz), 9 kHz (150 kHz—30 MHz).  
 4. Step size: 80Hz (0.009MHz-0.15MHz), 4 kHz (0.15MHz-30MHz), Scan time: auto.

# TR-4-E-010 Conducted Emission Test Result

**Test Site** : DDT 1# Shield Room D:\2018 CE report data\Q18101003-1E\CE.EM6  
**Test Date** : 2018-12-24 **Tested By** : Open  
**EUT** : Wall AP **Model Number** : WL8200-WH2  
**Power Supply** : DC 48V from AC Adapter **Test Mode** : Tx mode  
**Condition** : Temp:24.5°C,Humi:55%,Press:100.1kPa **LISN** : 2018 ENV216/LINE  
**Memo** :

Data: 42

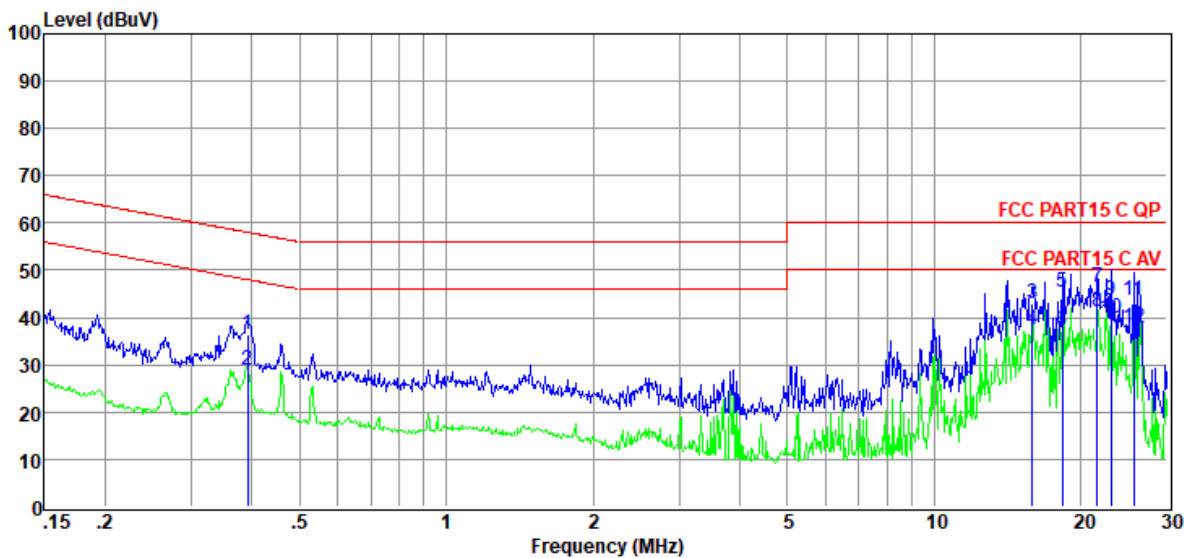

| Item<br>(Mark) | Freq.<br>(MHz) | Read Level<br>(dBμV) | LISN Factor<br>(dB) | Cable Loss<br>(dB) | Pulse Limiter Factor<br>(dB) | Result Level<br>(dBμV) | Limit Line<br>(dBμV) | Over Limit<br>(dB) | Detector | Phase |
|----------------|----------------|----------------------|---------------------|--------------------|------------------------------|------------------------|----------------------|--------------------|----------|-------|
| 1              | 0.39           | 16.92                | 9.64                | 0.02               | 9.86                         | 36.44                  | 58.03                | -21.59             | QP       | LINE  |
| 2              | 0.39           | 9.33                 | 9.64                | 0.02               | 9.86                         | 28.85                  | 48.03                | -19.18             | Average  | LINE  |
| 3              | 15.89          | 22.79                | 10.16               | 0.05               | 9.93                         | 42.93                  | 60.00                | -17.07             | QP       | LINE  |
| 4              | 15.89          | 17.45                | 10.16               | 0.05               | 9.93                         | 37.59                  | 50.00                | -12.41             | Average  | LINE  |
| 5              | 18.33          | 25.31                | 10.02               | 0.06               | 9.94                         | 45.33                  | 60.00                | -14.67             | QP       | LINE  |
| 6              | 18.33          | 16.95                | 10.02               | 0.06               | 9.94                         | 36.97                  | 50.00                | -13.03             | Average  | LINE  |
| 7              | 21.60          | 26.36                | 9.95                | 0.08               | 9.96                         | 46.35                  | 60.00                | -13.65             | QP       | LINE  |
| 8              | 21.60          | 21.28                | 9.95                | 0.08               | 9.96                         | 41.27                  | 50.00                | -8.73              | Average  | LINE  |
| 9              | 23.02          | 23.71                | 9.96                | 0.09               | 9.97                         | 43.73                  | 60.00                | -16.27             | QP       | LINE  |
| 10             | 23.02          | 19.86                | 9.96                | 0.09               | 9.97                         | 39.88                  | 50.00                | -10.12             | Average  | LINE  |
| 11             | 25.59          | 23.67                | 9.98                | 0.14               | 9.99                         | 43.78                  | 60.00                | -16.22             | QP       | LINE  |
| 12             | 25.59          | 17.84                | 9.98                | 0.14               | 9.99                         | 37.95                  | 50.00                | -12.05             | Average  | LINE  |

- Note: 1. Result Level = Read Level + LISN Factor + Pulse Limiter Factor + Cable loss.  
 2. If QP Result complies with AV limit, AV Result is deemed to comply with AV limit.  
 3. Test setup: RBW: 200 Hz (9 kHz—150 kHz), 9 kHz (150 kHz—30 MHz).  
 4. Step size: 80Hz (0.009MHz-0.15MHz), 4 kHz (0.15MHz-30MHz), Scan time: auto.



## **11. Antenna Requirements**

### **11.1. Limit**

For intentional device, according to FCC 47 CFR Section 15.203, an intentional radiator shall be designed to ensure that no antenna other than that furnished by the responsible party shall be used with the device. And according to FCC 47 CFR Section 15.247 (b), if transmitting antennas of directional gain greater than 6dBi are used, the power shall be reduced by the amount in dB that the directional gain of the antenna exceeds 6dBi.

### **11.2. Result**

The antennas used for this product are integrated antenna and other than that furnished by the responsible party shall be used with the device, the maximum peak gain of the transmit antenna is 3 dBi.

**END OF REPORT**