

WELCOME



INSTALLATION INSTRUCTIONS

MODEL: LED32911 – VC – BBZ

TABLE OF CONTENTS

DF SMART INSTALLATION

Warranty	3
What is Covered	3
What is Not Covered	3
Package Contents	4
Hardware	4
Fixture Components	4
Pre-Installation	5
Warning	5
Tools Required	5
Installation	6
Mounting the Hardware	6
Connecting the Wires	6
Mounting the Fixture	7
Assembling the Fixture	7
Important Information	8
Operation	8
Care & Cleaning	8
Troubleshooting	8

DF SMART APP SETUP

App Download & Account Setup	10
App Download	10
Account Setup	10
Add a Device	11
Controlling Your Device	13
Dimming	13
Function Access	13
Schedule Devices	14
Group Devices	14
Create a Scene	15
Share Device	15
Notice	16
FCC Statement	16
Disclaimer	16

WARRANTY

WHAT IS COVERED

The manufacturer warrants this light fixture to be free from defects in materials and workmanship for a period of three (3) years from date of purchase. This warranty applies only to the original consumer purchaser and only to products used in normal use and service. If this product is found to be defective, the manufacturer's only obligation, and your exclusive remedy, is the repair or replacement of the product at the manufacturer's discretion, provided that the product has not been damaged through misuse, abuse, accident, modifications, alternations, neglect, or mishandling.

WHAT IS NOT COVERED

This warranty shall not apply to any product that is found to have been improperly installed, set-up, or used in any way not in accordance with the instructions supplied with the product. This warranty shall not apply to a failure of the product as a result of an installation, or any other failure not relating to faulty material or workmanship. This warranty shall not apply to the finish on any portion of the product, such as surface and/or weathering, as this is considered normal wear and tear.

The manufacturer does not warrant and specifically disclaims any warranty, whether expressed or implied, of fitness for a particular purpose, other than the warranty contained herein. The manufacturer specially disclaims any liability and shall not be liable for any consequential or incidental loss or damage, including but not limited to any labor/expense costs involved in the replacement or repair of said product.

Contact the customer service team at 1-800-228-6197.

PACKAGE CONTENTS



Note: Hardware and fixture components are not shown to actual size.

HARDWARE

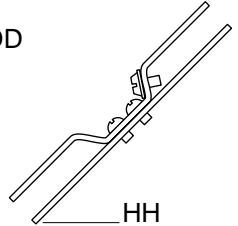
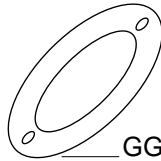

Part	Description	Qty
AA	Decorative Nut	2
BB	Hex Nut	2
CC	Wire Nut	3
DD	Shade Screw	2

Part	Description	Qty
EE	Mounting Screw	2
FF	Fixture Screw	2
GG	Shade Ring	1
HH	Mounting Bracket	1

FIXTURE COMPONENTS

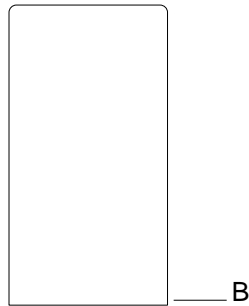
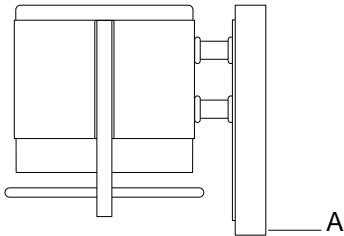

Part	Description	Qty
A	Fixture Body	1
B	Glass Shade	1

PRE-INSTALLATION



WARNING

Disconnect the power prior to removing or installing a light fixture.

- 1 Before installing this fixture or removing a previous fixture, disconnect the power by turning off the circuit breaker or removing the fuse at the fuse box.
- 2 Consult a qualified electrician if you have any electrical questions or if you need to replace the LED driver.
- 3 If you have any non-electrical questions about this fixture, please contact our customer service team at 1-800-228-6197.
- 4 Read all instructions before assembly and installation. To avoid damaging this product, assemble it on a soft, non-abrasive surface such as carpet or cardboard.
- 5 Register your product at www.dfsmartplus.com to enjoy more efficient support, product support alerts, and more.
- 6 Keep your receipt and these instructions as proof of purchase.

TOOLS REQUIRED



Phillips
Screwdriver



Wire
Cutter

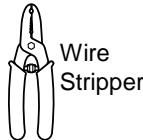

Wire
Stripper

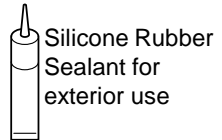

Silicone Rubber
Sealant for
exterior use



Ladder



Electrical
Tape



Safety
Goggles

INSTALLATION

MOUNTING THE HARDWARE

- 1 Thread the fixture screws (FF) into the holes of the mounting bracket (HH).
- 2 Thread the hex nuts (BB) onto the fixture screws (FF). Do not tighten the hex nuts (BB) at this time.
- 3 Pull the supply wires out from the outlet box and secure the mounting bracket (HH) to the outlet box by using the mounting screws (EE).
- 4 Place the back plate of the fixture body (A) over the outlet box and onto the fixture screws (FF).
- 5 Adjust the fixture screws (FF) until they protrude out from the back plate 1/4 in.
- 6 Remove the fixture body (A) and secure the position of the fixture screws (FF) by tightening the hex nuts (BB) against the mounting bracket (HH).

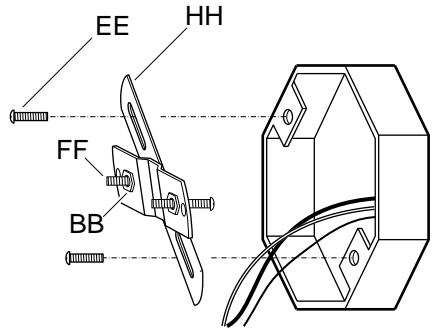

CONNECTING THE WIRES

- 1 Connect the black supply wire to the black fixture wire using a wire nut (CC).
- 2 Connect the white supply wire to the white fixture wire using a wire nut (CC).
- 3 Connect the fixture ground wire to the supply ground wire using a wire nut (CC).
- 4 Wrap all wire connections with electrical tape for a more secure connection.

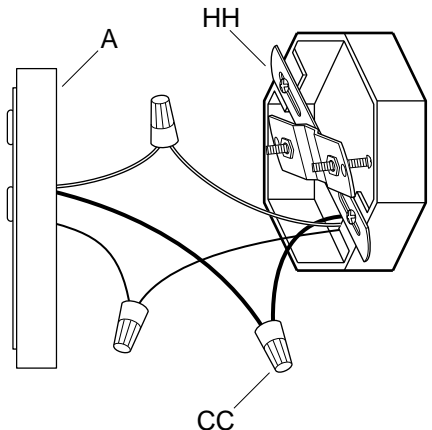

INSTALLATION CONTINUED

MOUNTING THE FIXTURE

- 1 Place the back plate of the fixture body (A) onto the fixture screws (FF) and secure it into place by using the lock nuts (AA) provided.
- 2 Caulk the upper 2/3rds of the back plate on the fixture body (A).
- 3 Leave the bottom 1/3rd un-caulked for drainage of any water that may leak into the enclosure.



Note: The manufacturer recommends a nondrying exterior caulking material. A good example is a clear silicone rubber sealant for exterior use.

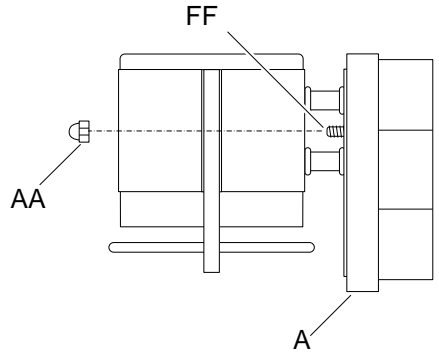

ASSEMBLING THE FIXTURE

- 1 Place the shade ring (GG) into the glass shade (B) and secure the glass shade (B) to the fixture body (A) using the shade screws (DD).

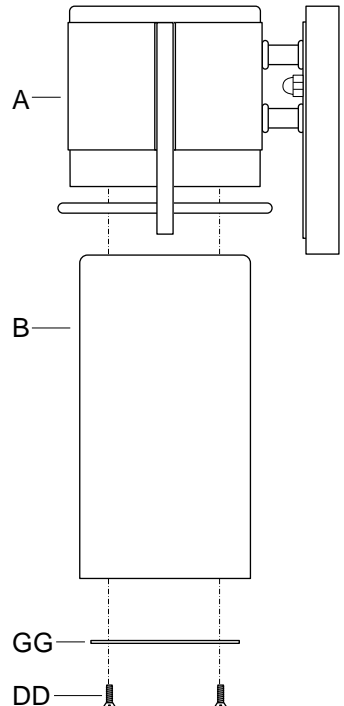

IMPORTANT INFORMATION

OPERATION

- 1 Turn on the power at the circuit breaker or fuse box.
- 2 Turn the light switch on to activate the fixture.

CARE & CLEANING



Note: Do not use any cleaners with chemicals, solvents, or harsh abrasives.

- 1 Use a dry or slightly dampened clean cloth to wipe the surface of the fixture.

TROUBLESHOOTING

Problem	Solution
The light will not turn on.	<ul style="list-style-type: none">■ Make sure the power supply is on.■ Test or replace the switch.■ Check the wiring.■ Replace the driver.
The fuse blows or circuit breaker trips when light is turned on.	<ul style="list-style-type: none">■ Check the wire connections.

For questions, comments, or missing parts please contact our customer service team at 1-800-228-6197.

**DF
SMARTPLUS
APP**



APP DOWNLOAD & ACCOUNT SETUP

APP DOWNLOAD

BEFORE YOU START:

- Set your phone/tablet to a 2.4G Wi-Fi network.
- Ensure that the DF SmartPlus app and the fixture are within the same Wi-Fi network range.
- Make sure the DF SmartPlus app has Wi-Fi network location access permission.
- Check that the phone/tablet has a strong signal.

- 1 Download the DF SmartPlus app from the App Store® or the Play Store®.



ACCOUNT SETUP

- 2 Open the app and tap **Register**. Fill in the region and the mobile number or email address. Tap **Next**.

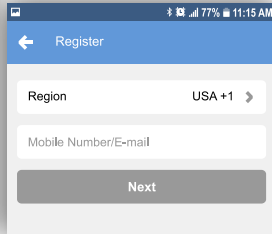
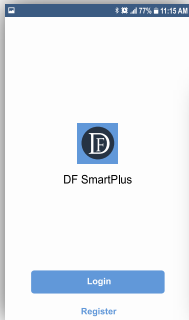

- 3 **Mobile Login:** Enter your mobile number. You will receive a text message with a verification code in the space provided. **OR**
Email Login: Enter your email address.

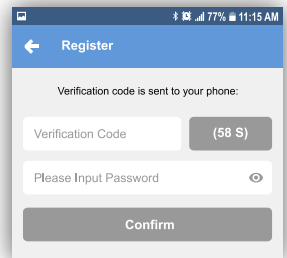

- 4 Create a password on the next screen.

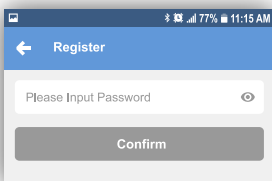

ADD A DEVICE

After log in, go to the **Add Device** page.

1 Click **ADD DEVICES** or **+** on the top right corner.

2 Select the device type **Lighting Devices**.

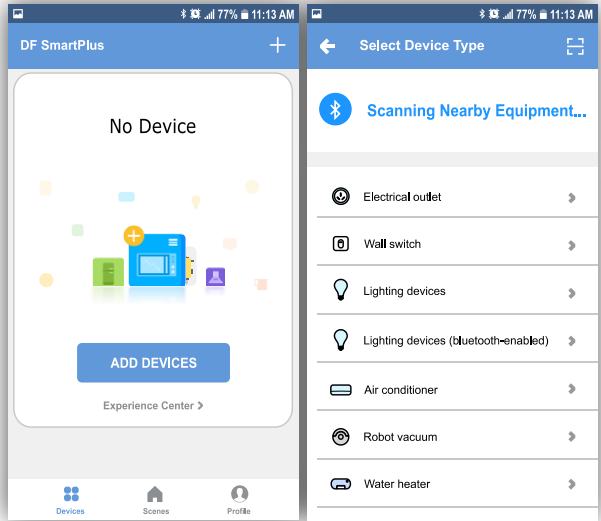

3 Your lighting fixture should blink rapidly. If it is not blinking, please follow these steps:

A Turn the power on, and let the lighting fixture run for 10 seconds or longer.

B Turn power on and off 5 times with the frequency of 1 second on and 1 second off to put the light into pairing mode:

OFF – ON – OFF – ON – OFF – ON

(wait)

(You can also tap **How to make light rapidly blink** for help.)

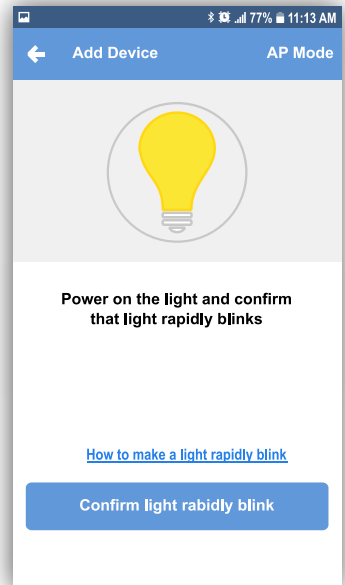

ADD A DEVICE CONTINUED

- 4 Tap **Confirm light rapidly blinks** to enter device lookup status.
- 5 Enter Wi-Fi and password, then click **Confirm**. The app will now search for your device. When the connection reaches between 7% and 12%, the light fixture will stop blinking.
- 6 Once connected, the app will show the device default name. Click the **pencil icon** to edit the default name.

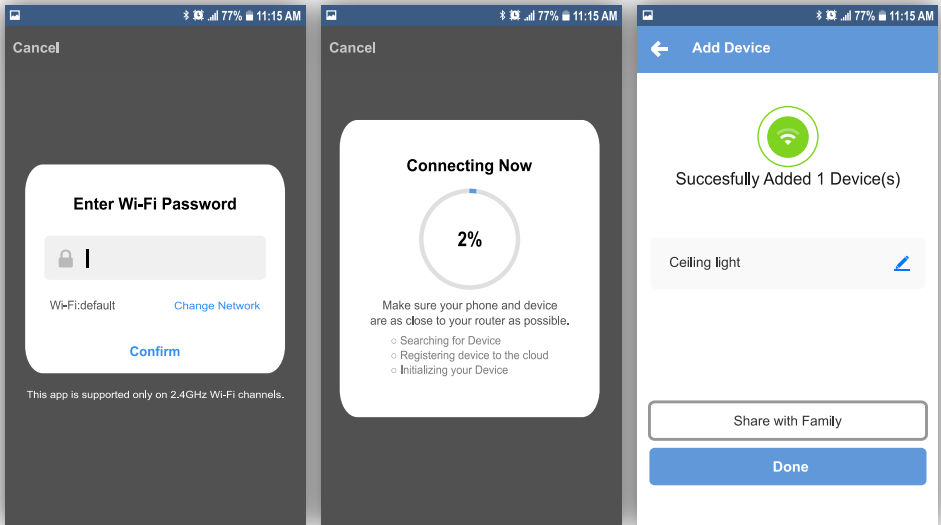

CONTROLLING YOUR DEVICE

DIMMING

- 1 Select the device to control on the device list.
- 2 Swipe the **power slider** on the right of the device field to switch the fixture on and off.
- 3 Tap the device field to enter the **Device Control** interface

In the device control interface:

- 4 Tap the **bulb icon** to switch the fixture on and off.
- 5 To dim the fixture (control the brightness), move the **Bright slider** right or left.

FUNCTION ACCESS

- 1 Tap the **Schedule** icon to enter the scheduler interface.
- 2 Tap the **More** icon (3 stacked dots) at the top right corner of the screen to access more functions.



Note: Go to www.dfsmartplus.com/connect for more instructions on changing device functions.

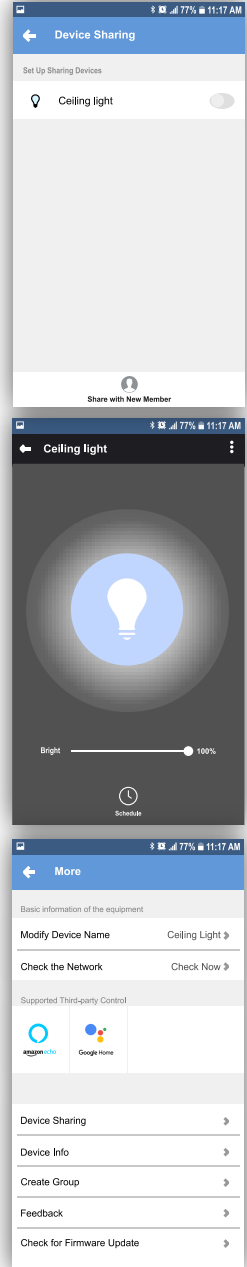

CONTROLLING YOUR DEVICE CONTINUED

SCHEDULE DEVICES

- 1 Tap **Add Schedule**.
- 2 Set the time.
- 3 Tap **Repeat** if you want to program multiple days for the same scheduled time.
- 4 Tap **Switch** to select to turn on or turn off the device, and then tap Confirm.
- 5 Tap **Save** on the top right corner.

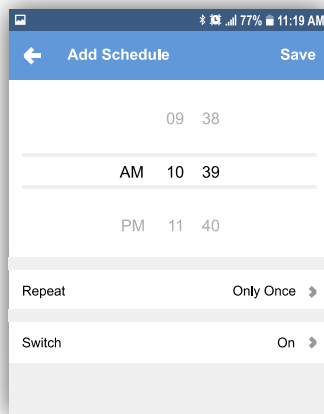

GROUP DEVICES



Note: You must have more than one DF smart plus device to create a group.

- 1 In the **More** interface, tap **Create Group**.
- 2 Select the devices to group together and tap **Save**.
- 3 Enter a Group Name
- 4 Tap **Confirm**. Now you can control your devices as a group.

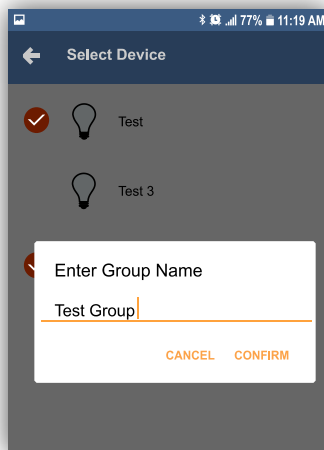

**NEED HELP CONNECTING TO AMAZON
ALEXA OR GOOGLE ASSISTANT?**

Get instructions: www.dfsmartplus.com/connect

CONTROLLING YOUR DEVICE CONTINUED

CREATE A SCENE

- 1 Tap **Scenes** icon in the bottom center.
- 2 Tap **+** at the top right corner and enter the scene name.
- 3 Tap **Add a condition** and make your selection. Then tap **Save**.
- 4 Tap **Add a task**, select a device, switch on/off, and then tap **Save**.
- 5 Tap **Save** to create the **Scene**. You can also edit a scene that was previously created.



Note: Go to www.dfsmartplus.com to see how to setup common scenes.

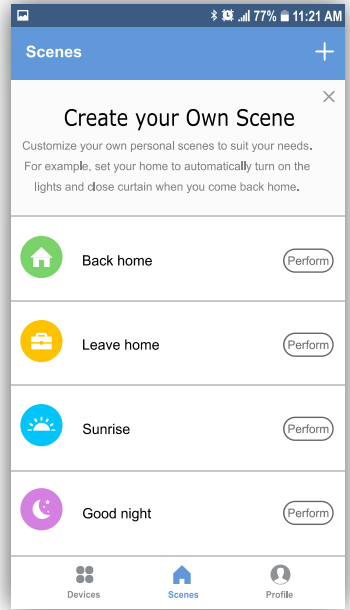

SHARE DEVICE

- 1 In the **More** interface, tap **Device Sharing**.
- 2 Tap **Add**.
- 3 Enter a new member mobile cell phone number or email address.
- 4 Tap **CONFIRM**. Now you can share a device with your family or friends. You can view and edit your share list in **Profile**.

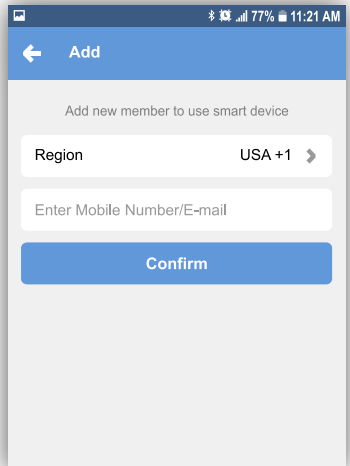

NOTICE

FCC STATEMENT

This device complies with Part 15 of the FCC Rules. Operation is subject to the following two conditions:

(1) This device may not cause harmful interference, and (2) this device must accept any interference received, including interference that may cause undesired operation.

NOTE 1: This equipment has been tested and found to comply with the limits for a Class B digital device, pursuant to part 15 of the FCC Rules. These limits are designed to provide reasonable protection against harmful interference in a residential installation. This equipment generates, uses and can radiate radio frequency energy and, if not installed and used in accordance with the instructions, may cause harmful interference to radio communications. However, there is no guarantee that interference will not occur in a particular installation. If this equipment does cause harmful interference to radio or television reception, which can be determined by turning the equipment off and on, the user is encouraged to try to correct the interference by one or more of the following measures:

- Reorient or relocate the receiving antenna.
- Increase the separation between the equipment and receiver.
- Connect the equipment into an outlet on a circuit different from that to which the receiver is connected.
- Consult the dealer or an experienced radio/TV technician for help.

NOTE 2: Any changes or modifications to this unit not expressly approved by the party responsible for compliance could void the user's authority to operate the equipment.

IC WARNING

This device complies with Industry Canada's licence-exempt RSSs. Operation is subject to the following two conditions:

(1) This device may not cause interference; and

(2) This device must accept any interference, including interference that may cause undesired operation of the device.

Le présent appareil est conforme aux CNR d'Industrie Canada applicables aux appareils radio exempts de licence. L'exploitation est autorisée aux deux conditions suivantes: (1) l'appareil ne doit pas produire de brouillage, et (2) l'utilisateur de l'appareil doit accepter tout brouillage radioélectrique subi, même si le brouillage est susceptible d'en compromettre le fonctionnement.

RF exposure statement

This equipment complies with the FCC RF radiation exposure limits set forth for an uncontrolled environment. This equipment should be installed and operated with a minimum distance of 20cm between the radiator and any part of your body.

This equipment meets the exemption from the routine evaluation limits in section 2.5 of RSS-102. It should be installed and operated with a minimum distance of 20cm between the radiator and any part of your body.

DISCLAIMER

Amazon, Alexa and all related logos are trademarks of Amazon.com, Inc. or its affiliates. Google Home is a trademark of Google Inc. Apple and the Apple logo are trademarks of Apple Inc., registered in the U.S. and other countries. Amazon Alexa and Google Home devices sold separately, and are not affiliated with Designers Fountain.



**SMART
PLUS™**

Designers Fountain

Los Angeles, CA 800-228-6197

info@designersftn.com

www.designersfountain.com