

4DKanKan Pro

Product Manual

V1.1

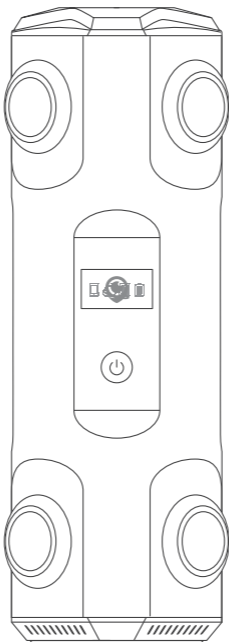

Instructions

Use Advice

4DKanKan Pro provides users with detailed shooting tutorials and background editing tutorial videos and graphic materials. Users can view it on the official website www.4dkankan.com. (Video tutorial QR code)



Notice before Use

Before using the 4DKanKan Pro, you need to download and install the 4DKanKan Pro App, register and log in.

1. Please search for "4DKanKan Pro" in the app store or use your mobile phone to scan the QR code below.



2. Go to "Me" - "Login to manage your projects", sign up an account according to the instructions.

(Note: Operation without an account is supported, but then the scenes on the cloud cannot be saved for a long time.)

3. Bind your device

After completing the registration and login, go to "Me" - "Bound Cameras" - "Management" - "Bind camera", scan the SN bar code or manually input the SN bar code at the bottom of the camera for binding.

After completing the binding, the scenes uploaded by the camera will be synchronized to the bound account.

Contents

• Instructions.....	3
Use Advice	3
Notice before Use.....	3
• Product Description	6
• Use 4DKanKan Pro	7
Install and Connect	7
Shooting mode	8
◦ Shooting mode 1:	
Left/right shooting on (recommended).....	8
◦ Shooting mode 2:	
Left/right shooting off(default).....	9
Shooting Plan	9
◦ Select shooting points.....	9
◦ Planning a route.....	10
◦ Spot Adjustment Function.....	11
◦ Panoramic Video Function.....	12
Save and Generate 3D Space.....	13
• FAQ	14
What is the difference between a 4DKanKan Pro and a panoramic camera?.....	14
What is the difference between a 4DKanKan Pro and a traditional 3D modeling camera?.....	14

What is the accuracy of the 4DKanKan Pro?.....	15
How can I watch the 3D scene via VR goggles?.....	15
About account.....	15
About hotspot position drift.....	16
4DKanKan Pro APP is compatible with which devices?....	16
About split shooting paths.....	16
About reshooting.....	17
About exposure.....	17
About the charging process.....	18
Others.....	18
• After-sales Service.....	20
Terms of service.....	20
Warranty for main unit.....	20
◦ Terms of warranty for main unit.....	20
◦ Limit of warranty.....	21
◦ Return process.....	22
Paid repair service.....	23
◦ Instructions to paid repair.....	23
◦ Paid maintenance service	23
Disclaimer.....	23
◦ User declaration on copyright.....	23
◦ Limit of liability	
• Specifications & Parameters.....	24
• After-sales service contact.....	25

Product Description

4DKanKan Pro is a professional 3D space camera that can automatically generate digital 3D space, compute distance and size in real time, achieve an image quality of up to 8K, and support 4X magnification. You can explore in the generated 3D scenes at any time and experience space roaming.

4DKanKan Pro is designed and created by Zhuhai 4Dage Network Technology Co., Ltd.(This text will be abbreviated as 4Dage.)

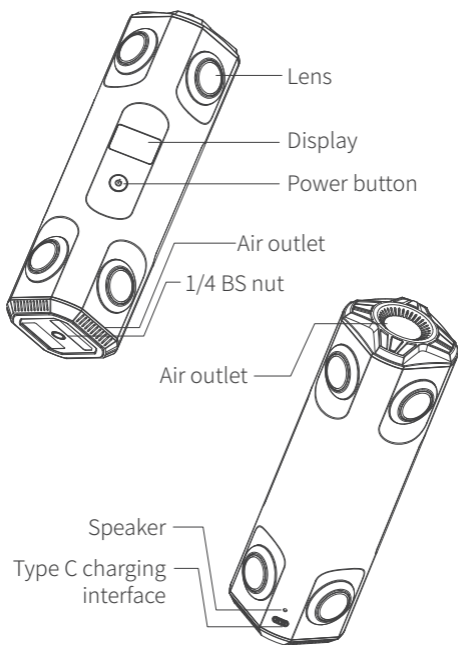

Use 4DKanKan Pro

Install and Connect

1. Install the camera

Fix the camera on a tripod with a height of a person's line of sight.



2. Turn on the camera

Press and hold the power button “” on the 4DKanKan Pro to turn on the camera. When the right interface is displayed on the LCD screen, the camera is turned on.

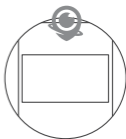

3. Connect to 4DKanKan Pro App

After the camera is turned on, go to your mobile phone's WiFi settings, find the camera WiFi with the prefix "4DKKPRO_" and connect it with the password "12345678". One camera corresponds to one WiFi.



Open the 4DKanKan App, click "Local" in the lower menu bar, and then click "+" in the lower right corner. When the camera battery level is displayed in the upper left corner, it is successfully connected.

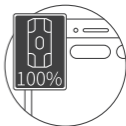

Shooting mode

At the bottom of the “Parameters” page, you can select a shooting mode: “Left/right shooting on” or “Left/right shooting off”.

Once the camera completes shooting at each spot, the image data is automatically stitched. You can check the shooting effect in the preview.

After confirming the shot, you can move the camera to the next spot and repeat the above steps.

Shooting mode 1: Left/right shooting on (recommended)

This mode will create a new scene and use the right and left lens of the camera in succession to record the 3D information at the point. The “L&R” here refers to the left and right of the photographer facing the LED screen.

1. Activate the “L&R” and click “Save”.

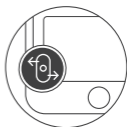

2. The lens on the right side of the camera is turned on first. Please stand on the left of the camera and press the shutter.

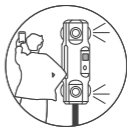

3. After the right side is shot, the App prompts “Please stand on the right side of the camera and shoot”. At this time, follow the instructions to move to the right side of the camera, press the shutter button, and the left lens will start shooting.



*Advantages of “L&R” shooting: It provides stable shooting performance and prevents the photographer from being captured.

Shooting mode 2: Left/right shooting off(default)

It will use the left and right lens of the camera at the same time to record the 3D information at the spot.

1. On the “Parameters” page, deactivate the “L&R” shooting, set the countdowns of shooting in the timer, and click the “Save” button in the upper right corner.



2. In the space where it can be assured that the mobile phone and camera are connected, find a hiding place to avoid being photographed, and then press the shutter.



3. After the shutter sounds, the system will calculate, after "combination is finished" is displayed on mobile screen, the shooting is completed.

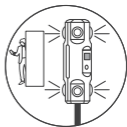

*Advantages of “Left/right shooting off”:
The shooting process is very simple.

Shooting Plan

Select shooting spots

1. A distance of 1.5 m between 2 shootingspots is recommended.

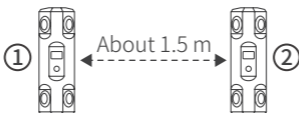

2. When shooting, the distance from the camera to walks should be 1.5m.

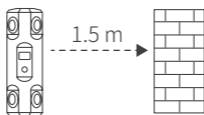

About “safe distance” of shooting

The working principle of the camera is derived from the recognition of a point cloud in space. If shooting from a too close or too far position, the lens may be unable to fully recognize the point cloud, which may cause image distortion and point misalignment. Therefore, we recommend a shooting distance of approx. 1.5m~2 m between the camera and the wall be. In addition, please try to avoid shooting in an environment with many mirrors, which may cause calculation errors.

Planning a route

1. Plan your route and follow the route direction to shoot at each spot.

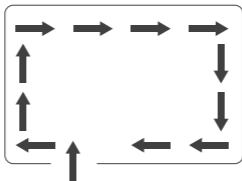

2. In larger spaces, it is recommended to take an S route.

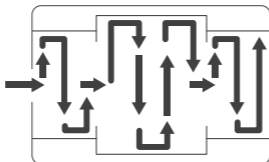

Spot Adjustment Function

This function is to assist the scene reconstruction. In case the the spot position shown on picture and the real spot position are different. This function corrects the spot position. The operation steps are as follows:

1. Switch the button on the bottom left, start the “Spot adjustment” mode by activating.



2. In this mode, you can hold the latest-shot spot and drag it to the correct position.



3. Ensure the new position is correct. Click “” to complete.

TIPS: This function is only available for the latest-shot spot, which cannot be applied on the previous ones.



Panoramic Video Function

Based on the collected data from specific a spot, the panoramic video function supports recording/playing a video on the spot. When roaming to a spot with a video, the panoramic video plays automatically, which lets the space tell the story. The process of panoramic video recording:

1. Plan the video content and determine the video spot because the video recording cannot be paused.

2. During the shooting, at the selected spot, set the main lens towards the direction to be shown in the video.

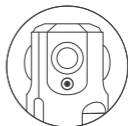

3. Finish the picture shooting of this spot first. Then switch to “Record” mode. Click “●” to start recording, click again to finish the recording. The video length is max. 30 minutes, the camera cannot be moved during the entire recording process.



4. The system will automatically save the video after shooting. You can continue shooting other spots by switching to “Photo” mode.



Save and Generate 3D Space

1. After completing the shooting of all the spots, click “Save” in the upper right corner of the shooting frame, follow the prompts to add description and click “Save” again.



2. Click the “” button, and the “Camera network” interface will appear. Select a WiFi with Internet connection, and then return to the initial page.



3. Click the “” button again, and then you can decide whether to set the password for the 3D scene or not. Click “Upload”, after the upload is completed, the 3D-model will be automatically generated in the cloud.



4. After completing the computation, click to enter the scene to view the generated results on the cloud.



FAQ

What is the difference between a 4DKanKan Pro and a panoramic camera?

A panoramic camera captures panoramic pictures or videos, while the 4DKanKan Pro produces a 3D scene of the space.

3D scene vs panoramic photo

A 3D scene contains structural information and image information of the captured space. The user can roam anywhere in the 3D scene and obtain the length, width and height of the space. A panoramic photo is a 2D image that cannot record the 3D structural information of a space and can only be rotated by 720° at a fixed point.

3D scene vs panoramic video

A 3D scene contains structural information and image information of the captured space. The user can independently select the roaming route and the length of stay in the 3D scene without any limitation of time and perspective. In a panoramic video, it is possible to choose a line of sight, but you can only watch the video according to the fixed route and rhythm provided by the photographer.

What is the difference between a 4DKanKan Pro and a traditional 3D modeling camera?

Traditional 3D modeling cameras are highly dependent on professionals, who are required to complete on-site scanning and modify models afterwards. In terms of model generation speed, it takes more than 300 minutes for shooting and model calculation for a space of 150m².

4DKanKan Pro uses artificial intelligent algorithms to generate 3D space autonomously without manual intervention. Non-professional users can also easily operate it after reading the manual.

What is the accuracy of the 4DKanKan Pro?

The resolution of 3D scene shot by a 4DKanKan Pro can achieve 8K, and it supports 4X detail magnification. After the 3D scene is generated, the measurement information in the space can be read with centimeter-level accuracy.

How can I watch the 3D scene via VR goggles?

Open the generated 3D space on the mobile phone and click the "⋮" in the lower right corner of the viewing interface to switch to VR mode. After that, you will convert to VR mode. Then place and fix the phone to matching VR goggles, then you can watch the immersive 3D scene.

About account

In order to help users to get started quickly, 4DKanKan Pro provides a "Camera Account" and a "User Account".

The "Camera Account" is the initial account of the camera generated at its manufacture. You just need to connect to the camera WiFi to enter the camera account. The camera account can be used for shooting, and editing and managing scenes, but top-up and capacity expansion are not supported under camera account.

The "User Account" refers to an account registered by the user in the APP or on the official website and can be logged in with a password. After binding the user account to a camera's SN number, you may top-up and expand the capacity for the camera account.

Note: If you connect the camera in the APP to enter the camera account, then sign up and log in to a user account in the APP, the system will simultaneously display the cloud scenes from the camera account to the user account.

About hotspot position drift

At present, the space range for adding hotspots is limited to the model space where the calculation is completed. If the hotspots are marked out of the model space, "position drift" may occur. You can improve the accuracy through the following operations: Enter the "Model Edit" page, adjust the ground edge lines, expand the model space to cover the hotspots, then add hotspots again.

Note: In the definition of the scene space range, the 2D-perspective shall prevail. The visible range is within the scene space.

4DKanKan Pro APP is compatible with which devices?

4DKanKan Pro iOS version is compatible with iPhone 11/11 Pro/11 Pro Max, iPhone X, iPhone XS, iPhone XS Max, iPhone XR, iPhone 8/8 plus, iPhone 7/7 plus, iPhone 6s/6s plus, and iPhone SE with iOS 11 system and above.

The Android version of 4DKanKan Pro APP requires following configuration or above:

- 1.Processor: Snapdragon 6 series 655 or above, Snapdragon 8 series 820 or above, Kirin 710 or above.
- 2.System requirements: Android 7.0 (64-bit OS) or above.
- 3.Memory RAM: above 2GB

About split shooting paths

The split shooting path means that after finishing the first path during the shooting process, you need to return to a junction point and continue to shoot another path. Split shooting paths requires the use of the "Spot Adjustment" feature.



On the "Project" interface, click the "", open the "Spot Adjustment" function, then tap the nearby shooting. After

that, click the "" in the lower left again, close the "Spot Adjustment" function, so the "Junction Spot" is done. You can start shooting a new path from this spot on

Note: It is recommended that the distance from the new point to the old one be within 1.5m.

About reshooting

The solution for scenes that need to be reshot is as follows:

Find the scenes that need to be reshot in "Local", and click "..."-> "Continue Shooting". Enter the "Shooting Project", click the "" in the lower left corner, open the "Spot Adjustment" function, and then click the point closest to the selected shooting area. After that, click the "" in the lower left corner again to turn off the "Spot Adjustment" function. In this way the junction spot of the new area will be determined. You may start shooting the new path from this point.(It is recommended that the distance from the new point to the old one be within 1.5 m).

Notes:

1.The working principle of the camera is derived from the recognition of the point cloud in space. If the old point cloud in space cannot be recognized at the new shooting spot, it may cause a calculation failure of the new point. Below are the common mis-operations: no junction spot is set in the reshot area/the junction spot is far from the first point during the actual reshooting.

2.If the reshot area is near the last shooting spot, click the "" in the upper right corner to quickly set the last shooting spot as the junction spot.

About exposure

Please try to avoid direct sunlight on the lens, otherwise it will cause overexposure. In addition, in a dark indoor environment, overexposure could also be a prominent problem.

About the charging process

In order to ensure the best performance of the camera, the cooling fan will automatically turn on during the charging process. If you shut down the camera while charging, the system will stop running the fan. When plugging in, the fan will be turned on again. After the battery is fully charged, the camera will automatically shut down.

Others

How long does it take to process the modeling calculation after uploading?

A: For a space of 100m^2 , the calculation time is about 10 minutes. When more than one user uploads the calculation at the same time, the server will carry out the calculation according to the sequence.

Where is the data stored?

A: The data is stored on the cloud servers.

Can 4D KanKan Pro realize 3D reconstruction on objects?

A: Our camera is mainly used for reconstruction of space rather than small objects. The current version of camera does not support object modelling. But we are planning to launch this function in our future versions. Please stay tuned!

What are the special restrictions for the space reconstruction?

Shooting spots: support a maximum of 200 spots per scene
Hotspots: support a maximum of 30 spots per scene

After the calculation, is it possible to modify the scene?

When the model has been uploaded, you can download the model to local, modify it in detail, and then upload it again when you are satisfied.

Can the 4DKanKan Pro do spatial measurement?

Yes. You can turn on the ruler function and measuring function in the measuring tool. While roaming in the scene, the dimension of the space will display automatically. You can also select any 2 spots in the scene and measure the distance in between.

How can I create a scene of a multi-floor space?

You may create a scene for each floor, as well as add hotspots within each scene. Inside the hotspots you may add the link of scenes for other floors. Once the scenes are finalized, you could go to any floor easily by clicking on the links in the hotspots.

Can I acquire the data of models and upload them on my own website?

A: You can log in the PC terminal and enter "My Scene", click the "  " in the upper right corner of the viewing interface to start the embedde production. Then you can apple copythe code from the "share-embed model" and embed the code in your website to realize it.

During shooting, the lens(es) cannot be turned at a large angle. In order to achieve a good scene modeling, please do not turn the lens(es) at a large angle during the shooting process. This action will cause the camera's built-in gyro data to deviate.

Notes on long-term storage

The battery will self-discharge during storage. If the camera is not powered for a long time, it may cause the battery life to be reduced or damaged. It is recommended to power on for more than five minutes every two months to maintain battery life.

After-sales Service

Terms of service

Warranty is provided to buyers that have purchased 3D cameras (main unit) on 4DKanKan's self-operated online channels (4DKanKan's official website and Alibaba's international site).

Warranty for main unit

(I) Terms of warranty for main unit

1. Calculating from the 2nd day after the receipt, if a functional failure occurs due to non-human damage within 7 days and is verified by 4DAGE, you may either return it, or exchange it for the same model with same specifications, or repair it for free.

2. Calculating from the 2nd day after the receipt, if a functional failure occurs due to non-human damage during the 8th to the 15th day and is verified by 4DAGE, you may exchange it for the same model with same specifications, or repair it for free.

3. Calculating from the date of receipt, if a functional failure occurs due to non-human damage within 1 year and is verified by 4DAGE, you can enjoy free repair service.

4. Calculating from the date of receipt, if a functional failure occurs due to non-human damage within 1 year and the camera cannot be used normally after repaired for two times, you can choose free repair, or contact customer service with the effective repair record provided by the repairer in the warranty card to check whether it can be exchanged. If yes, you may choose to exchange it for the same model with same specifications or return it.

(II) Limit of warranty

Warranty will not be provided by 4DAGE if:

1. The warranty has expired;
2. The damage is caused by the user's failure to use, preserve or maintain the product in accordance with the product manual;
3. The damage is caused by misuse such as falling, squeezing, or immersion in water;
4. The damage is caused by force majeure such as floods, fires, and lightning strikes;
5. you may exchange it for the same model with same specifications, or repair it for free;
6. The failure or accident is caused by using non-original accessories;

7.The camera is not purchased from 4DAGE's official channels, or any of the model number, serial number and manufacturing number on the product have been changed, deleted, moved or cannot be identified;

8.The warranty covers the main unit only. All the accessories, such as software, CD and user manual, are not under warranty;

9.If the appearance of the product is worn or scratched, product return is not applicable;

10. Damage caused by unauthorized disassembly, repair, modification or unauthorized root.

(III)Return process

1.Find the after-sales hotline or email address on the official website to contact service staff;

2.After the service staff confirms that it can be returned or exchanged, the full set of products (including gifts) and invoices should be sent or brought to 4DAGE together;

3.4DAGE will handle the case according to the test result;

4.The shipping cost incurred by the return should be covered by the user. If the user does not settle the shipping cost, it will be deducted from the refund amount according to the actual price. The refund path is the same as the payment path. The arrival time of refund depends on the bank and payment institution.

Paid repair service

(I) Instructions to paid repair

4DAGE provides qualified paid repair services for products that are accidentally damaged, fall beyond the warranty scope or do not meet the warranty conditions.

(II) Paid repair process

1. Find the after-sales hotline or email address on the official website to contact service staff, and wait for the follow-up by service staff;
2. After confirming the repair content and repair cost with service staff, make the payment;
3. Send the product to 4DAGE Co., Ltd. for repair.

Disclaimer

(I) User declaration on copyright

Users shall understand and acknowledge that, once the user voluntarily uploads the works (video, music, pictures, etc.) created by using 4DKanKan to 4DAGE's official website, the exhibition and use rights of the works are shared by the user and 4DAGE.

(II) Limit of liability

To the fullest extent permitted by current law, 4DAGE shall not be liable for any direct, indirect or incidental damages resulting from the copying or downloading of the information or materials contained in 4DKanKan's user manual by users.

Specifications & Parameters

Size Height: 220.7 mm Width: 78.2 mm Depth: 78.2 mm	Lens Type: 200-degree fisheye lens Aperture: f/2.0 Quantity: 8
Sensor Range: 1/2.3 inch Quantity: 8	Resolution 4608 x 3456 pixels (Each) 8192*4096 pixels (Total)
Memory 16GB	Battery Capacity 7.26V 4400 mAh
WiFi Protocols 802.11a/b/g/n、 2.4/5GHz	Types of Device Interface TYPE C

Contact us

Customer service

After-sales service (China Mainland): 4006698025

Email (Global): service@4dage.com

Alibaba International Station (Overseas):

<https://4dage.en.alibaba.com/>

Note: At present, 4DKanKan at the after-sales service channels in overseas markets, mainly for email and customer service consultation of Alibaba International Station

Media interview

Email: pr@4dage.com

www.4dkankan.com

Scan the QR code and follow
4DAGE' s WeChat account



4DKanKan Pro

FCC Radiation Exposure Statement:

This equipment complies with FCC radiation exposure limits set forth for an uncontrolled environment. This equipment should be installed and operated with minimum distance 20cm between the radiator & your body.

FCC Warning

This device complies with Part 15 of the FCC Rules. Operation is subject to the following two conditions:

(1) This device may not cause harmful interference, and (2) this device must accept any interference received, including interference that may cause undesired operation.

NOTE 1: This equipment has been tested and found to comply with the limits for a Class B digital device, pursuant to part 15 of the FCC Rules. These limits are designed to provide reasonable protection against harmful interference in a residential installation. This equipment generates uses and can radiate radio frequency energy and, if not installed and used in accordance with the instructions, may cause harmful interference to radio communications. However, there is no guarantee that interference will not occur in a particular installation. If this equipment does cause harmful interference to radio or television reception, which can be determined by turning the equipment off and on, the user is encouraged to try to correct the interference by one or more of the following measures:

- Reorient or relocate the receiving antenna.
- Increase the separation between the equipment and receiver.
- Connect the equipment into an outlet on a circuit different from that to which the receiver is connected.
- Consult the dealer or an experienced radio/TV technician for help.

NOTE 2: Any changes or modifications to this unit not expressly approved by the party responsible for compliance could void the user's authority to operate the equipment.