

S

T

S

L

A

B



RADIO TEST REPORT

Report No:STS1809204W04

Issued for

BEIJING HUACHUANGHULIAN TECHNOLOGY CO.,LTD

2507, 21F, Building 2, No. 128 South Fourth Ring West Road,
Fengtai District, Beijing China

Product Name:	Smart bracelet
Brand Name:	DI KANG
Model Name:	BC-02
Series Model:	N/A
FCC ID:	2ARKPBC-02
Test Standard:	FCC Part 15.225



Any reproduction of this document must be done in full. No single part of this document may be reproduced without permission from STS, All Test Data Presented in this report is only applicable to presented Test sample.



TEST REPORT CERTIFICATION

Applicant's name : BEIJING HUACHUANGHULIAN TECHNOLOGY CO.,LTD
 Address..... : 2507, 21F, Building 2, No. 128 South Fourth Ring West Road, Fengtai District, Beijing China
Manufacture's Name : BEIJING HUACHUANGHULIAN TECHNOLOGY CO.,LTD
 Address..... : 2507, 21F, Building 2, No. 128 South Fourth Ring West Road, Fengtai District, Beijing China

Product description

Product Name : Smart bracelet
 Brand Name : DI KANG
 Model Name..... : BC-02
 Series Model..... : N/A

Test Standards : FCC Part15.225

Test procedure..... : ANSI C63.10: 2013

This device described above has been tested by STS, the test results show that the equipment under test (EUT) is in compliance with the FCC requirements. And it is applicable only to the tested sample identified in the report.

This report shall not be reproduced except in full, without the written approval of STS, this document only be altered or revised by STS, personal only, and shall be noted in the revision of the document.

Date of Test

Date (s) of performance of tests..... : 08 Oct. 2018 ~18 Oct. 2018

Date of Issue : 18 Oct. 2018

Test Result..... : **Pass**

Testing Engineer : *Chris chen*

 (Chris chen)

Technical Manager : *Sean she*

 (Sean she)

Authorized Signatory : *Vita Li*

 (Vita Li)





TABLE OF CONTENTS	Page
1. SUMMARY OF TEST RESULTS	5
1.1 TEST FACTORY	5
1.2 MEASUREMENT UNCERTAINTY	5
2. GENERAL INFORMATION	6
2.1 GENERAL DESCRIPTION OF THE EUT	6
2.2 DESCRIPTION OF THE TEST MODES	7
2.3 BLOCK DIGRAM SHOWING THE CONFIGURATION OF SYSTEM TESTED	7
2.4 DESCRIPTION OF NECESSARY ACCESSORIES AND SUPPORT UNITS	8
2.5 EQUIPMENTS LIST FOR ALL TEST ITEMS	9
3. EMC EMISSION TEST	10
3.1 CONDUCTED EMISSION MEASUREMENT	10
3.2 TEST PROCEDURE	11
3.3 TEST SETUP	11
3.4 EUT OPERATING CONDITIONS	11
3.5 TEST RESULTS	12
4. RADIATED EMISSION MEASUREMENT	14
4.1 RADIATED EMISSION LIMITS	14
4.2 TEST PROCEDURE	15
4.3 TEST SETUP	16
4.4 EUT OPERATING CONDITIONS	16
5. FREQUENCY TOLERANCE	21
5.1 REQUIREMENT	21
5.2 TEST PROCEDURE	21
5.3 TEST SETUP	21
5.4 EUT OPERATION CONDITIONS	21
5.5 TEST RESULTS	22
6. 20DB BANDWIDTH	23
6.1 LIMIT	23
6.2 TEST PROCEDURE	23
6.3 TEST SETUP	23
6.4 EUT OPERATION CONDITIONS	23
6.5 TEST RESULTS	24



TABLE OF CONTENTS	Page
7. ANTENNA REQUIREMENT	25
7.1 STANDARD REQUIREMENT	25
7.2 EUT ANTENNA	25
APPENDIX 1- PHOTOS OF TEST SETUP	26





1. SUMMARY OF TEST RESULTS

Test procedures according to the technical standards:

FCC Part15 15.225 , Subpart C			
Standard Section	Test Item	Judgment	Remark
15.207	Conducted Emission	PASS	--
15.209 15.225(a)(b)(c)(d)	Radiated Emission	PASS	--
15.225(e)	Frequency Tolerance	PASS	--
15.203	Antenna Requirement	PASS	--
15.215	20dB Bandwidth	PASS	--

NOTE: (1) "N/A" denotes test is not applicable in this Test Report

(2) All tests are according to ANSI C63.10-2013

1.1 TEST FACTORY

Shenzhen STS Test Services Co., Ltd.
1/F., Building B, Zhuoke Science Park, No.190, Chongqing Road,
Fuyong Street, Bao'an District, Shenzhen, Guangdong, China
CNAS Registration No.: L7649; FCC Registration No.: 625569
IC Registration No.: 12108A; A2LA Certificate No.: 4338.01;

1.2 MEASUREMENT UNCERTAINTY

The reported uncertainty of measurement $y \pm U$, where expanded uncertainty U is based on a standard uncertainty multiplied by a coverage factor of $k=2$, providing a level of confidence of approximately **95** %.

No.	Item	Uncertainty
1	Conducted Emission (9KHz-150KHz)	± 2.88 dB
2	Conducted Emission (150KHz-30MHz)	± 2.67 dB
3	RF power,conducted	± 0.71 dB
4	Spurious emissions,conducted	± 0.63 dB
5	All emissions,radiated (9KHz-30MHz)	± 3.02 dB
6	All emissions,radiated (30MHz-200MHz)	± 3.80 dB
7	All emissions,radiated (200MHz-1000MHz)	± 3.97 dB



2. GENERAL INFORMATION

2.1 GENERAL DESCRIPTION OF THE EUT

Product Name	Smart bracelet								
Trade Name	DI KANG								
Model Name	BC-02								
Serial Model	N/A								
Model Difference	N/A								
Product Description	<p>The EUT is a Smart bracelet</p> <table border="1"><tr><td>Operation Frequency:</td><td>13.56MHz</td></tr><tr><td>Modulation Type:</td><td>ASK</td></tr><tr><td>Antenna Designation:</td><td>Please see Note 3.</td></tr><tr><td>Antenna Gain (dBi)</td><td>-3 dBi</td></tr></table>	Operation Frequency:	13.56MHz	Modulation Type:	ASK	Antenna Designation:	Please see Note 3.	Antenna Gain (dBi)	-3 dBi
Operation Frequency:	13.56MHz								
Modulation Type:	ASK								
Antenna Designation:	Please see Note 3.								
Antenna Gain (dBi)	-3 dBi								
Battery	Battery(rating): Rated Voltage: 3.7V Charge Limit: 4.2V Capacity: 120mAh								
Hardware version number	271-ST4021-B10V0								
Software version number	V1.0.1								
Connecting I/O Port(s)	Please refer to the User's Manual								

Note:

1. For a more detailed features description, please refer to the manufacturer's specifications or the User's Manual.
2. Table for filed Antenna

Ant.	Brand	Model Name	Antenna Type	Connector	Gain (dBi)	NOTE
A	DI KANG	BC-02	FPC Antenna	N/A	-3	ANT.



2.2 DESCRIPTION OF THE TEST MODES

To investigate the maximum EMI emission characteristics generates from EUT, the test system was pre-scanning tested base on the consideration of following EUT operation mode or test configuration mode which possible have effect on EMI emission level. Each of these EUT operation mode(s) or test configuration mode(s) mentioned above was evaluated respectively.

Pretest Mode	Description
Mode 1	TX Mode

For Conducted Test	
Final Test Mode	Description
Mode 1	TX Mode

For Radiated Emission	
Final Test Mode	Description
Mode 1	TX Mode

Note:

We have be tested for all avaiable U.S. voltage and frequencies(For 120V,50/60Hz and 240V, 50/60Hz) for which the device is capable of operation.

2.3 BLOCK DIGRAM SHOWING THE CONFIGURATION OF SYSTEM TESTED

Radiated Spurious Emission Test

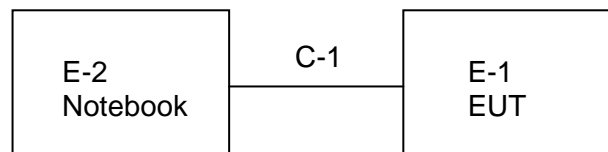

Conducted Emission Test

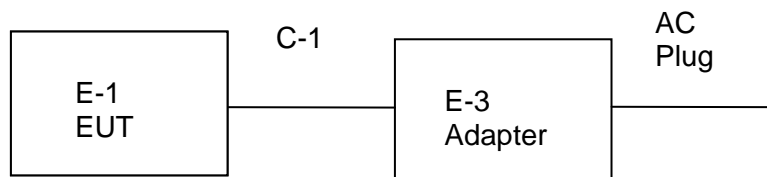



2.4 DESCRIPTION OF NECESSARY ACCESSORIES AND SUPPORT UNITS

The EUT has been tested as an independent unit together with other necessary accessories or support units. The following support units or accessories were used to form a representative test configuration during the tests.

Necessary accessories

Item	Equipment	Mfr/Brand	Model/Type No.	Series No.	Note
N/A	N/A	N/A	N/A	N/A	N/A

Support units

Item	Equipment	Mfr/Brand	Model/Type No.	Series No.	Note
E-2	Notebook	DELL	VOSTRO.3800	N/A	E-2
C-1	USB Cable	N/A	N/A	N/A	C-1

Note:

- (1)The support equipment was authorized by Declaration of Confirmation.
- (2)For detachable type I/O cable should be specified the length in cm in 『Length』 column.



2.5 EQUIPMENTS LIST FOR ALL TEST ITEMS

Radiation Test equipment

Kind of Equipment	Manufacturer	Type No.	Serial No.	Last calibration	Calibrated until
EMI Test Receiver	R&S	ESPI	102086	2018.10.13	2019.10.12
Bilog Antenna	TESEQ	CBL6111D	34678	2017.11.02	2020.11.01
Passive Loop (9K--30MHz)	ZHINAN	ZN30900C	16035	2017.03.11	2020.03.10
Semi-anechoic chamber	Changling	966	N/A	2018.10.24	2020.10.23

Conduction Test equipment

Kind of Equipment	Manufacturer	Type No.	Serial No.	Last calibration	Calibrated until
Test Receiver	R&S	ESCI	101427	2018.10.13	2019.10.12
LISN	R&S	ENV216	101242	2018.10.13	2019.10.12
conduction Cable	EM	C01	N/A	2018.03.11	2019.03.10
Temperature & Humidity	Mieo	HH660	N/A	2018.10.13	2019.10.12



3. EMC EMISSION TEST

3.1 CONDUCTED EMISSION MEASUREMENT

3.1.1 POWER LINE CONDUCTED EMISSION LIMITS

Operating frequency band. In case the emission fall within the restricted band specified on Part 15. 207(a) limit in the table below has to be followed.

FREQUENCY (MHz)	Class B (dBuV)		Standard
	Quasi-peak	Average	
0.15 -0.5	66 - 56 *	56 - 46 *	CISPR
0.50 -5.0	56.00	46.00	CISPR
5.0 -30.0	60.00	50.00	CISPR

0.15 -0.5	66 - 56 *	56 - 46 *	FCC
0.50 -5.0	56.00	46.00	FCC
5.0 -30.0	60.00	50.00	FCC

Note:

- (1) The tighter limit applies at the band edges.
- (2) The limit of " * " marked band means the limitation decreases linearly with the logarithm of the frequency in the range.

The following table is the setting of the receiver

Receiver Parameters	Setting
Attenuation	10 dB
Start Frequency	0.15 MHz
Stop Frequency	30 MHz
IF Bandwidth	9 kHz

3.2 TEST PROCEDURE

- a. The EUT was placed 0.8 meters from the horizontal ground plane with EUT being connected to the power mains through a line impedance stabilization network (LISN). All other support equipments powered from additional LISN(s). The LISN provide 50 Ohm/ 50uH of coupling impedance for the measuring instrument.
- b. Interconnecting cables that hang closer than 40 cm to the ground plane shall be folded back and forth in the center forming a bundle 30 to 40 cm long.
- c. I/O cables that are not connected to a peripheral shall be bundled in the center. The end of the cable may be terminated, if required, using the correct terminating impedance. The overall length shall not exceed 1 m.
- d. LISN at least 80 cm from nearest part of EUT chassis.
- e. For the actual test configuration, please refer to the related Item –EUT Test Photos.

3.3 TEST SETUP

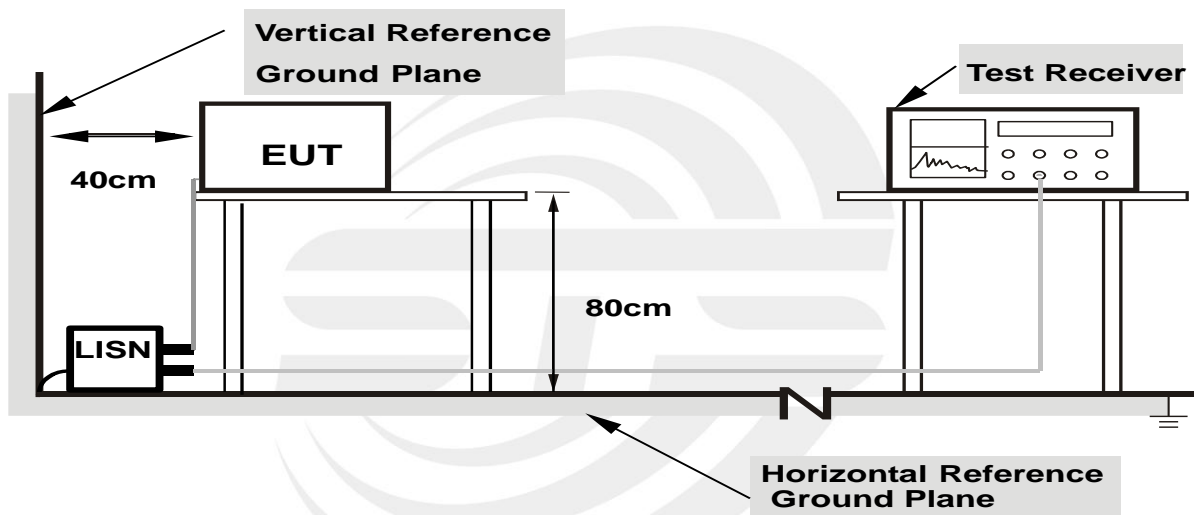

- Note: 1. Support units were connected to second LISN.**
2. Both of LISNs (AMN) are 80 cm from EUT and at least 80 from other units and other metal planes

3.4 EUT OPERATING CONDITIONS

The EUT was configured for testing in a typical fashion (as a customer would normally use it). The EUT has been programmed to continuously transmit during test. This operating condition was tested and used to collect the included data.



3.5 TEST RESULTS

Temperature:	26.1 °C	Relative Humidity:	60%
Test Voltage:	AC 120V/60Hz	Phase:	L
Test Mode:	Mode 1		

Frequency (MHz)	Reading (dBuV)	Correct Factor(dB)	Result (dBuV)	Limit (dBuV)	Margin (dB)	Remark
0.1540	26.93	20.20	47.13	65.78	-18.65	QP
0.1540	9.95	20.20	30.15	55.78	-25.63	AVG
0.1900	25.72	20.30	46.02	64.04	-18.02	QP
0.1900	6.91	20.30	27.21	54.04	-26.83	AVG
0.2460	21.87	20.52	42.39	61.89	-19.50	QP
0.2460	5.81	20.52	26.33	51.89	-25.56	AVG
0.5100	13.91	20.42	34.33	56.00	-21.67	QP
0.5100	1.66	20.42	22.08	46.00	-23.92	AVG
3.8100	12.00	20.06	32.06	56.00	-23.94	QP
3.8100	-2.34	20.06	17.72	46.00	-28.28	AVG
9.5500	16.00	19.87	35.87	60.00	-24.13	QP
9.5500	6.52	19.87	26.39	50.00	-23.61	AVG

Remark:

- All readings are Quasi-Peak and Average values.
- Margin = Result (Result = Reading + Factor) – Limit

100.0 dBuV

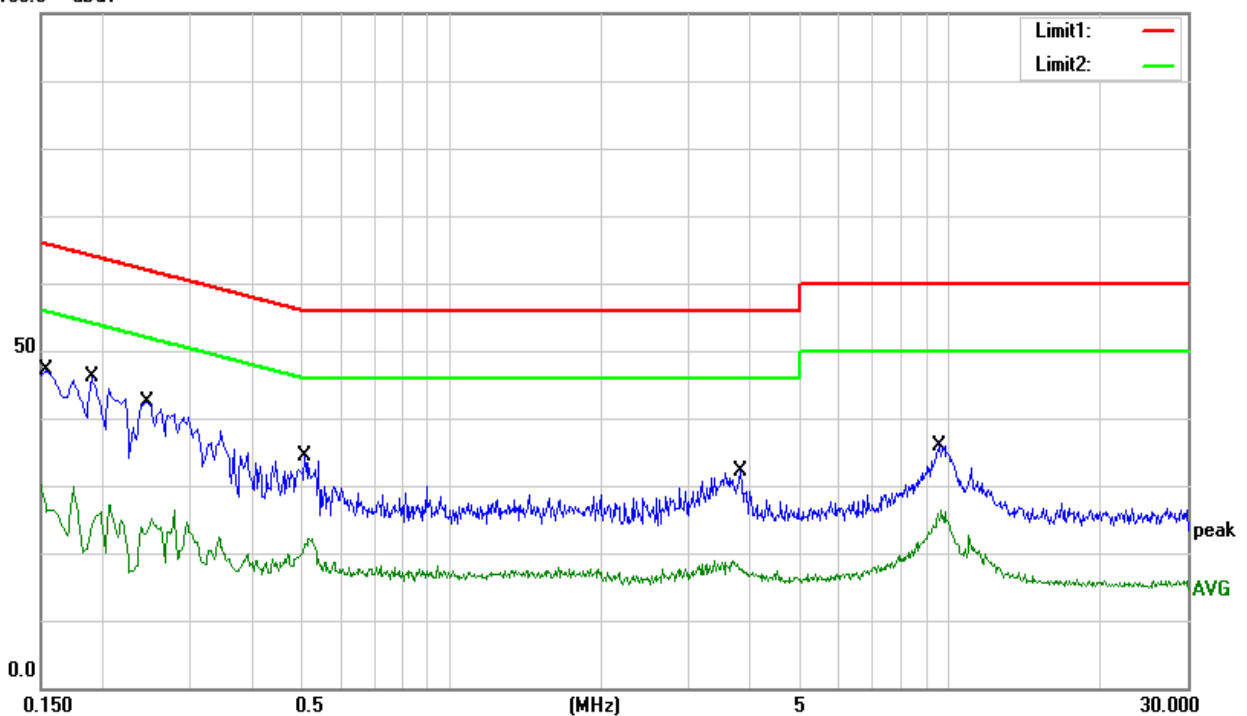



Temperature:	26.1 °C	Relative Humidity:	60%
Test Voltage:	AC 120V/60Hz	Phase:	N
Test Mode:	Mode 1		

Frequency (MHz)	Reading (dBuV)	Correct Factor(dB)	Result (dBuV)	Limit (dBuV)	Margin (dB)	Remark
0.1540	27.29	20.20	47.49	65.78	-18.29	QP
0.1540	10.85	20.20	31.05	55.78	-24.73	AVG
0.2020	24.71	20.34	45.05	63.53	-18.48	QP
0.2020	7.34	20.34	27.68	53.53	-25.85	AVG
0.2740	23.01	20.65	43.66	61.00	-17.34	QP
0.2740	6.54	20.65	27.19	51.00	-23.81	AVG
0.5140	14.41	20.42	34.83	56.00	-21.17	QP
0.5140	2.16	20.42	22.58	46.00	-23.42	AVG
3.7100	12.96	20.06	33.02	56.00	-22.98	QP
3.7100	-1.19	20.06	18.87	46.00	-27.13	AVG
9.8460	18.70	19.86	38.56	60.00	-21.44	QP
9.8460	8.45	19.86	28.31	50.00	-21.69	AVG

Remark:

1. All readings are Quasi-Peak and Average values.
2. Margin = Result (Result = Reading + Factor) – Limit

100.0 dBuV

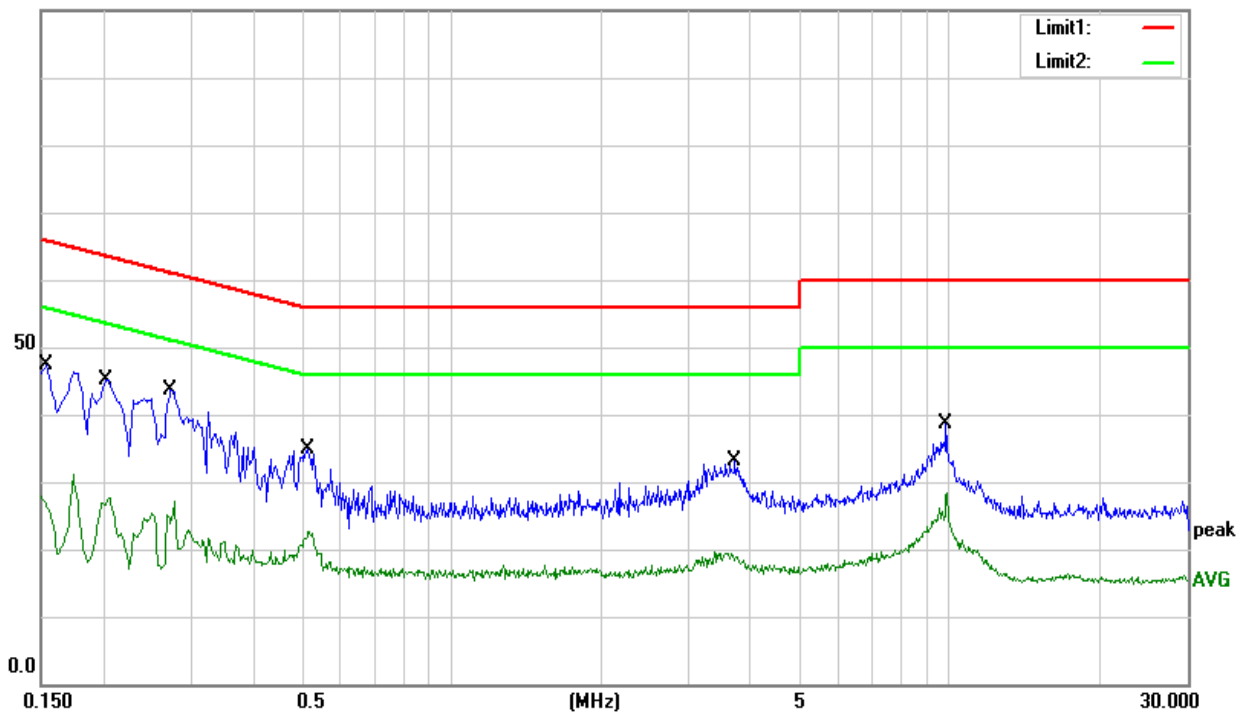

4. RADIATED EMISSION MEASUREMENT

4.1 RADIATED EMISSION LIMITS

- (a) The field strength of any emissions within the band 13.553-13.567 MHz shall not exceed 15,848 microvolts/meter at 30 meters.
- (b) Within the bands 13.410-13.553 MHz and 13.567-13.710 MHz, the field strength of any emissions shall not exceed 334 microvolts/meter at 30 meters.
- (c) Within the bands 13.110-13.410 MHz and 13.710-14.010 MHz the field strength of any emissions shall not exceed 106 microvolts/meter at 30 meters.
- (d) The field strength of any emissions appearing outside of the 13.110-14.010 MHz band shall not exceed the general radiated emission limits in §15.209.

(Radiated Emission <30MHz (9KHz-30MHz, H-field)

According to FCC section 15.225, for <30MHz, Radiated emissions were measured according to ANSI C63.10. The EUT was set to transmit at the highest output power. The EUT was set 30 meter away from the measuring antenna. The loop antenna was positioned 1 meter above the ground from the center of the loop. The measuring bandwidth was set to 10KHz. (Note: During testing the receive antenna was rotated about its axis to maximize the emission from the EUT)

There was no detected Restricted bands and Radiated suprious emission below 30MHz. The 30m limit was converted to 3m Limit using square factor(x) as it was found by measurements as follows;

$$3\text{ m Limit(dBuV/m)} = 20\log(X)+40\log(30/3) = 20\log(15,848)+40\log(30/3) = 124\text{dBuV}$$

$$3\text{ m Limit(dBuV/m)} = 20\log(X)+40\log(30/3) = 20\log(334)+40\log(30/3) = 90.47\text{dBuV}$$

$$3\text{ m Limit(dBuV/m)} = 20\log(X)+40\log(30/3) = 20\log(106)+40\log(30/3) = 80.506\text{dBuV}$$

$$3\text{ m Limit(dBuV/m)} = 20\log(X)+40\log(30/3) = 20\log(30)+40\log(30/3) = 69.54\text{dBuV}$$

Except as provided elsewhere in this Subpart, the emissions from an intentional radiator shall not exceed the field strength levels specified in the following table:

LIMITS OF RADIATED EMISSION MEASUREMENT (Frequency Range 9kHz-1000MHz)

Frequency range (MHz)	Field Strength@30m		Field Strength@3m
	µV/m	dBµV/m	dBµV/m
Below 13.110	30	29.5	69.5
13.110 ~ 13.410	106	40.5	80.5
13.410 ~ 13.553	334	50.5	90.5
13.553 ~13.567	15.848	84	124.0
13.567 ~ 13.710	334	50.5	90.5
13.710 ~14.010	106	40.5	80.5
Above 14.010	30	29.5	69.5

NOTE:

- a) Field Strength (dBµV/m) = 20*log[Field Strength (µV/m)].
- b) In the emission tables above, the tighter limit applies at the Band edge.

Radiated Emission >30MHz (30MHz-1GHz, E-field)

According to FCC section 15.205, the field strength of radiated emissions from intentiona radiators at a distance of 3 meters shall not exceed the following values:



Frequencies (MHz)	Field Strength (micorvolts/meter)	Measurement Distance (meters)
30~88	100	3
88~216	150	3
216~960	200	3
Above 960	500	3

Receiver Parameter	Setting
Attenuation	Auto
Start ~ Stop Frequency	9kHz~90kHz / RB 200Hz for PK & AV
Start ~ Stop Frequency	90kHz~110kHz / RB 200Hz for QP
Start ~ Stop Frequency	110kHz~490kHz / RB 200Hz for PK & AV
Start ~ Stop Frequency	490kHz~30MHz / RB 9kHz for QP
Start ~ Stop Frequency	30MHz~1000MHz / RB 120kHz for QP

4.2 TEST PROCEDURE

- The test is performed in a 3m Semi-Anechoic Chamber; the antenna factor, cable loss and so on of the site (factors) is calculated to correct the reading. The EUT is placed on a 0.8m high insulating Turn Table, and keeps 3m away from the Test Antenna, which is mounted on a variable-height antenna master tower. For the test Antenna
- In the frequency range of 9KHz to 30MHz, magnetic field is measured with Loop Test Antenna. The Test Antenna is positioned with its plane vertical at 1m distance from the EUT. The center of the Loop Test Antenna is 1m above the ground. During the measurement the Loop Test Antenna rotates about its vertical axis for maximum response at each azimuth about the EUT.
- In the frequency range above 30MHz, Bi-Log Test Antenna (30MHz to 1GHz) used. Test Antenna is 3m away from the EUT. Test Antenna height is varied from 1m to 4m above the ground to determine the maximum value of the field strength. The emission levels at both horizontal and vertical polarizations should be tested.
- The initial step in collecting conducted emission data is a spectrum analyzer peak detector mode pre-scanning the measurement frequency range. Significant peaks are then marked and then Quasi Peak detector mode re-measured.
- If the Peak Mode measured value compliance with and lower than Quasi Peak Mode Limit, the EUT shall be deemed to meet QP Limits and then no additional QP Mode measurement performed.
- For the actual test configuration, please refer to the related Item –EUT Test Photos.

NOTE:

Both horizontal and vertical antenna polarities were tested and performed pretest to three orthogonal axis. The worst case emissions were reported

4.3 TEST SETUP

(A) Radiated Emission Test-Up Frequency Below 30MHz

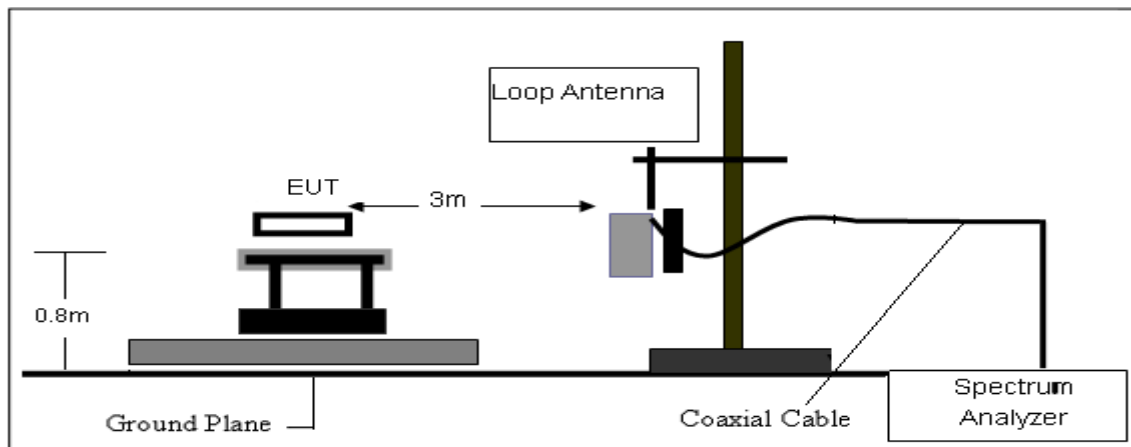

(B) Radiated Emission Test-Up Frequency 30MHz~1GHz

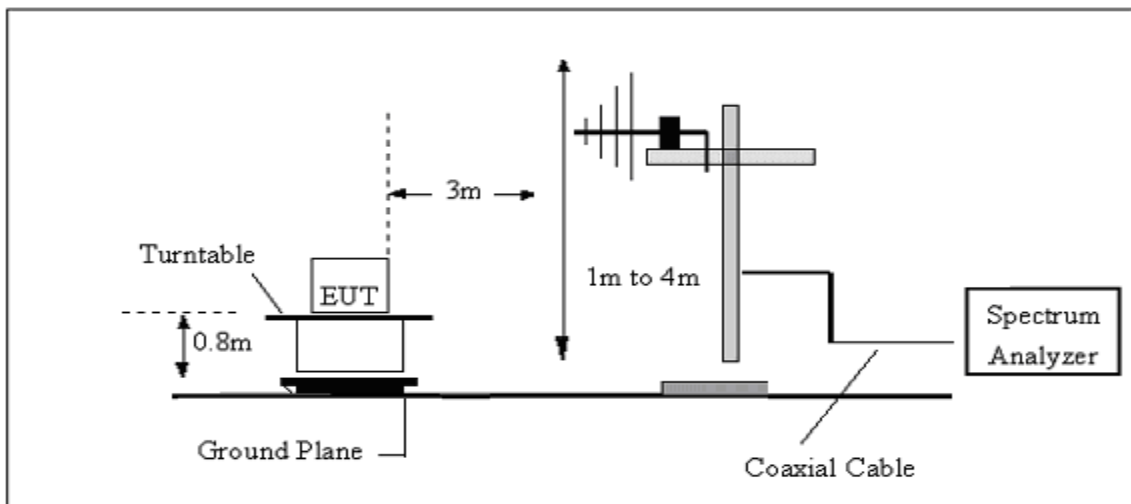

4.4 EUT OPERATING CONDITIONS

The EUT tested system was configured as the statements of 2.3 Unless otherwise a special operating condition is specified in the follows during the testing.



4.5 FIELD STRENGTH CALCULATION

The field strength is calculated by adding the Antenna Factor and Cable Factor and subtracting the Amplifier Gain and Duty Cycle Correction Factor (if any) from the measured reading. The basic equation with a sample calculation is as follows:

$$FS = RA + AF + CL - AG$$

Where

FS = Field Strength

CL = Cable Attenuation Factor (Cable Loss)

RA = Reading Amplitude

AG = Amplifier Gain

AF = Antenna Factor

For example

Frequency (MHz)	FS (dB μ V/m)	RA (dB μ V/m)	AF (dB)	CL (dB)	AG (dB)	Factor (dB)
300	40	58.1	12.2	1.6	31.9	-18.1

$$\text{Factor} = \text{AF} + \text{CL} - \text{AG}$$





4.6 TEST RESULTS

(Radiated Emission<30MHz (9KHz-30MHz, H-field))

Temperature:	25.5 °C	Relative Humidity:	57%
Test Voltage:	DC 3.7V from battery	Polarization:	--
Test Mode:	Mode 1		

Note: Horizontal is the worst polarization.

Freq. (MHz)	Reading (dBuV/m)	Limit (dBuV/m)	Margin (dB)	Detector type	State P/F
12.12	59.11	69.54	-10.43	QP	PASS
13.33	59.46	80.51	-21.05	QP	PASS
13.45	59.67	90.47	-30.8	QP	PASS
13.56	95.95	124	-28.05	QP	PASS
13.67	61.17	90.47	-29.3	QP	PASS
13.89	62.21	80.51	-18.3	QP	PASS
15.21	60.3	69.54	-9.24	QP	PASS

Note:15.31(f)(2) f < 30 MHz, extrapolation factor of 40 dB/decade of distance



Between 30-1000MHz

Temperature:	25.5 °C	Relative Humidity:	57%
Test Voltage:	DC 3.7V from battery	Phase:	Horizontal
Test Mode:	Mode 1		

Frequency (MHz)	Reading (dBuV)	Correct Factor(dB/m)	Result (dBuV/m)	Limit (dBuV/m)	Margin (dB)	Remark
45.2166	38.60	-19.01	19.59	40.00	-20.41	QP
68.1514	41.09	-24.15	16.94	40.00	-23.06	QP
133.1511	45.69	-17.54	28.15	43.50	-15.35	QP
167.8243	44.72	-19.15	25.57	43.50	-17.93	QP
499.4247	39.25	-8.91	30.34	46.00	-15.66	QP
798.9797	34.38	-3.45	30.93	46.00	-15.07	QP

Remark:

1. Margin = Result (Result =Reading + Factor)-Limit
80.0 dBuV/m

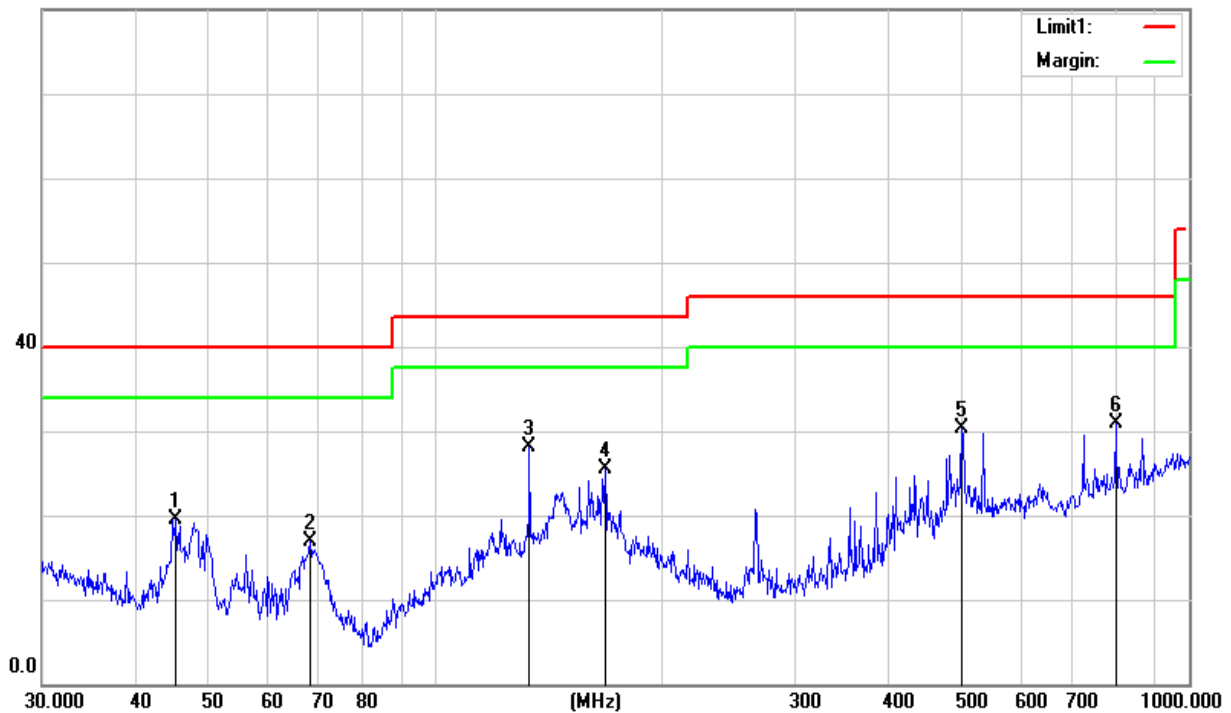



Temperature:	25.5 °C	Relative Humidity:	57%
Test Voltage:	DC 3.7V from battery	Phase:	Vertical
Test Mode:	Mode 1		

Frequency (MHz)	Reading (dBuV)	Correct Factor(dB/m)	Result (dBuV/m)	Limit (dBuV/m)	Margin (dB)	Remark
47.9940	37.78	-20.45	17.33	40.00	-22.67	QP
67.2022	39.72	-24.17	15.55	40.00	-24.45	QP
118.6014	40.47	-17.78	22.69	43.50	-20.81	QP
259.2338	29.37	-15.15	14.22	46.00	-31.78	QP
455.9058	35.29	-10.29	25.00	46.00	-21.00	QP
731.9203	32.31	-3.97	28.34	46.00	-17.66	QP

Remark:

1. Margin = Result (Result =Reading + Factor)–Limit

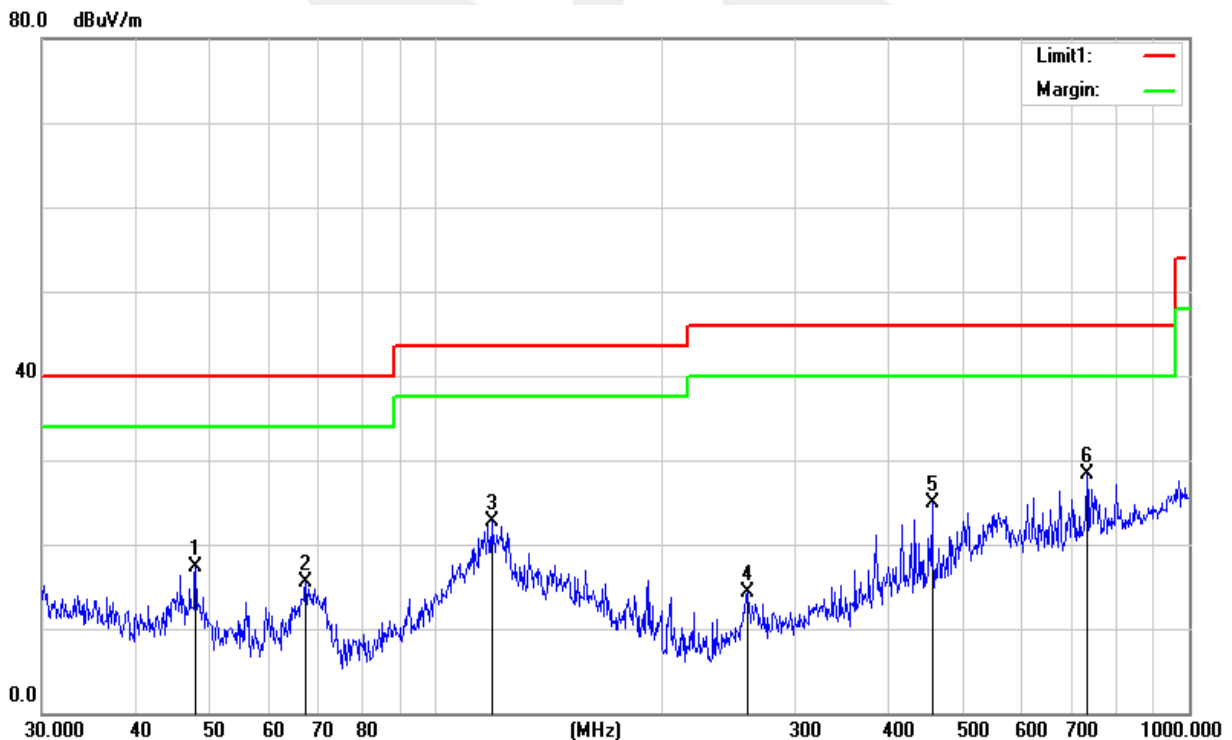

5. FREQUENCY TOLERANCE

5.1 REQUIREMENT

According to FCC section 15.225, the devices operating in the 13.553-13.567 MHz shall maintain the carrier frequency within 0.01% of the operating frequency over the temperature variation of -20°C to +50°C using an environmental chamber. The primary supply voltage is varied from 85% to 115% of the voltage normally at the input to the device or at the power supply terminals if cables are not normally supplied.

5.2 TEST PROCEDURE

According to FCC section 15.225(e), The frequency tolerance of the carrier signal shall be maintained within $\pm 0.01\%$ of the operating frequency over a temperature variation of -20 degrees to + 50 degrees C at normal supply voltage, and for a variation in the primary supply voltage from 85% to 115% of the rated supply voltage at a temperature of 20 degrees C. For battery operated equipment, the equipment tests shall be performed using a new battery.

5.3 TEST SETUP

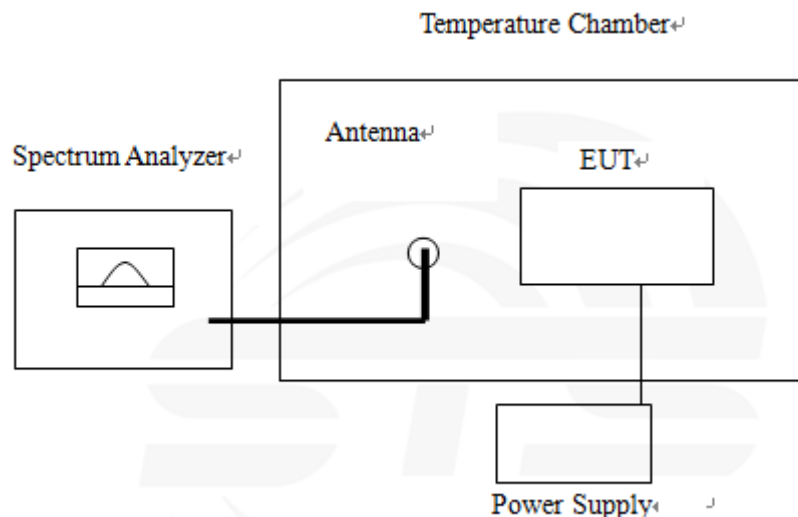

The EUT which is powered by the Battery, is coupled to the Spectrum Analyzer; the RF load attached to the EUT antenna terminal is 50Ohm; the path loss as the factor is calibrated to correct the reading.

5.4 EUT OPERATION CONDITIONS

The EUT tested system was configured as the statements of 2.3 Unless otherwise a special operating condition is specified in the follows during the testing.



5.5 TEST RESULTS

Temperature:	25 °C	Relative Humidity:	50%
Test Voltage:	DC 3.7V from battery	Test Mode:	TX Mode

13.56MHz

VOLTAGE(%)	Test Conditions		Frequency(Hz)	Deviation(%)	Limit	Verdict
	Power (VDC)	Temperature (°C)				
100	3.7	+20°C(Ref)	13560753	0.00555	±0.01%	PASS
100		-20	13560751	0.00554	±0.01%	
100		-10	13560750	0.00553	±0.01%	
100		0	13560754	0.00556	±0.01%	
100		10	13560754	0.00556	±0.01%	
100		20	13560753	0.00555	±0.01%	
100		25	13560753	0.00555	±0.01%	
100		30	13560750	0.00553	±0.01%	
100		40	13560755	0.00557	±0.01%	
100		50	13560750	0.00553	±0.01%	
Battery End Point	3.3	20	13560753	0.00555	±0.01%	
115	4.2	20	13560754	0.00556	±0.01%	

Note: Battery End Point=(Normal voltage)±10%

6. 20DB BANDWIDTH

6.1 LIMIT

According to FCC section 15.215(c), the 20dB bandwidth should be contained within the frequency band designated in the rule section under which the EUT is operated, it was measured with a spectrum analyzer connected the EUT while the EUT is operating in transmission mode.

6.2 TEST PROCEDURE

Intentional radiators operating under the alternative provisions to the general emission limits, as contained in §13.553-13.567 MHz and in subpart E of this part, must be designed to ensure that the 20 dB bandwidth of the emission, or whatever bandwidth may otherwise be specified in the specific rule section under which the equipment operates, is contained within the frequency band designated in the rule section under which the equipment is operated. In the case of intentional radiators operating under the provisions of subpart E, the emission bandwidth may span across multiple contiguous frequency bands identified in that subpart. The requirement to contain the designated bandwidth of the emission within the specified frequency band includes the effects from frequency sweeping, frequency hopping and other modulation techniques that may be employed as well as the frequency stability of the transmitter over expected variations in temperature and supply voltage. If a frequency stability is not specified in the regulations, it is recommended that the fundamental emission be kept within at least the central 80% of the permitted band in order to minimize the possibility of out-of-band operation.

1. Set RBW = 1 KHz.
2. Set VBW = 1 KHz.
3. Detector = Peak.
4. Trace mode = max hold.
5. Sweep = auto couple.
6. Allow the trace to stabilize.
7. Measure the maximum width of the emission that is constrained by the frequencies associated with the two outermost amplitude points (upper and lower frequencies) that are attenuated by 6 dB relative to the maximum level measured in the fundamental emission.

6.3 TEST SETUP

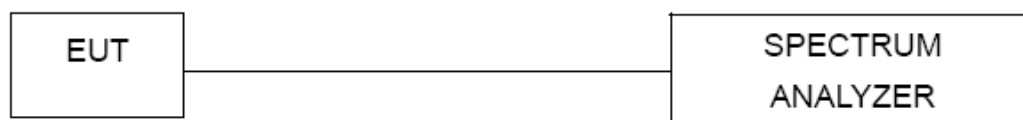

6.4 EUT OPERATION CONDITIONS

The EUT tested system was configured as the statements of 2.3 Unless otherwise a special operating condition is specified in the follows during the testing.



6.5 TEST RESULTS

Temperature:	25 °C	Relative Humidity:	60%
Test Voltage:	DC 3.7V from battery	Test Mode:	TX Mode

13.56MH

Centre Frequency	Measurement		
	20dB Bandwidth (KHz)	99% Bandwidth (KHz)	Frequency Range (MHz)
13.56MHz	2.629	2.280	13.553-13.567

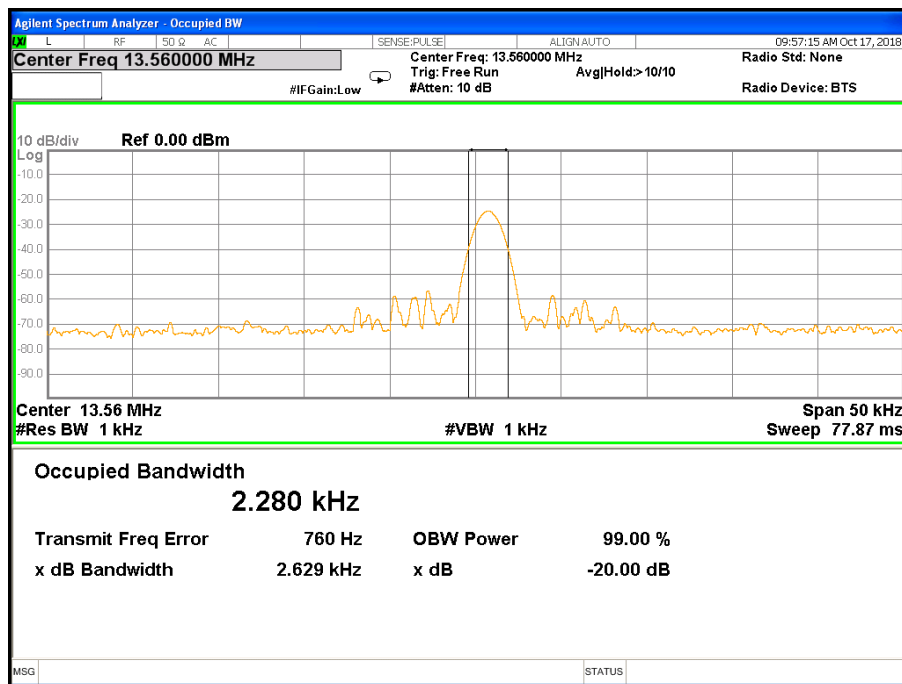



7. ANTENNA REQUIREMENT

7.1 STANDARD REQUIREMENT

15.203 requirement: For intentional device, according to 15.203: an intentional radiator shall be designed to ensure that no antenna other than that furnished by the responsible party shall be used with the device.

7.2 EUT ANTENNA

1. The EUT antenna is FPC Antenna. It comply with the standard requirement.
2. The antenna is connected to the PCB via a shrapnel.





APPENDIX 1- PHOTOS OF TEST SETUP

Note: See test photos in setup photo document for the actual connections between Product and support equipment.

*****END OF THE REPORT*****

