



**INNOTRIK**

HD Conference Camera with  
Wireless Speakerphone  
AUCTOPUS I-1208

User Manual

V1.0.0

Shenzhen Innotrik Technology Co., Ltd

<b>Legal Statement</b>	01
<b>Preface</b>	02
<b>Safety Precautions</b>	03
<b>1 Product Overview</b>	04
1.1 Production Introduction	04
1.2 Features	04
1.3 Package list	05
1.4 Component description	06
<b>2 Connection</b>	07
<b>3 Operating Description</b>	08
<b>4 Specification</b>	11



## Copyright Statement

© Shenzhen Innotrik Technology Co., Ltd . All rights reserved.

Information contained in this document should not be reproduced, spread, distributed or stored by any person in any form without prior written license of Shenzhen Innotrik Technology Co., Ltd (hereinafter referred to as "Yinluo").

The products referred to in this document may contain software proprietary to Yinluo or, probably, a third party. The above-mentioned software should not be reproduced, distributed, modified, extracted, decompiled, disassembled, decoded, reverse engineered, leased, transferred or sub-licensed or other copyright violations.

## Declaration of Trademark

 INNOTRIK 音络  AUCTOPUS<sup>®</sup> are trademarks or registered trademarks of Shenzhen Innotrik Technology Co., Ltd . Other trademarks or company names that may be referred to in this document are properties of their respective owners.

## Update and Modification

To enhance the security of this product and provide you better user experience, Yinluo may improve this product by automatically updating the software without prior notice and assume no responsibility.









Dahua reserves the right to change any information contained in the document at any time, which will be then included in a new version, without prior notice. Some features of the product allow subtle differences before and after change.

## Overview

This document describes in detail the quick configuration of the AUCTOPUS I-1208 series.

## Symbol Conventions

For the purpose of this document, the following signs that may exist herein mean as below:

Symbol	Description
 Danger	Danger indicates an imminently hazardous situation which, if not avoided, will result in death or serious injury.
 Warning	Warning indicates moderately or lowly hazardous situation which, if not avoided, will result in minor or moderate injury.
 Caution	Caution alerts you to possible equipment damage, data loss, performance degradation or unpredictable results if you do not follow instructions.
 Anti -static	Alert you to static-sensitive equipment.
 Protection Against Electric Shock	Alert you to high voltage.
 Laser Radiation	Alert you to intense laser radiation.
 Tip	Help you with solving a problem or saving your time.
 Note	Additional information for the main body, which can be known as an emphasis and supplement to the main body.

# Safety Precautions

Before using the product, read and abide by the following requirements to prevent damage to the product or your belongings.

## Caution

- Transport, use, and store the product only under the appropriate temperatures and humidity.
- Install the product in a well-ventilated place and do not block the device's air vents.
- Install the product in a steady place.
- Do not place the product in damp, dusty, or smoky areas.
- Do not place the product in direct sun light or near a heat source.
- Do not let the product come in contact with liquids.
- Do not disassemble the product at will.

## Warning

- Turn off all power sources when opening the device cover or when repairing the device to prevent electric shock.
- Use a new battery of the same kind to replace the old one.
- Use the recommended power cord and use it within its rated specifications.
- If a power plug or appliance coupler is used as a disconnecting device, please ensure that the disconnecting device is always easy to operate.

## Important Statements

- The physical product shall prevail while this User Manual is for reference only.
- The product will automatically update itself. If there is an upgrade, no notifications will be given.
- For the latest procedure and supplementary documentation, please contact the service center.
- Should there be any doubts or any disputes over the product instructions, the company reserves the rights of final interpretation.

## 1.1 Product Introduction

AUCTOPUS I-1208 is a separate audio-video conference camera, configured with 120 ° shooting angle, 1080P HD webcam and 2.4 G wireless speakerphone, suitable for small and medium-sized conference scenes, personal business, home or leisure place.







## 1.2 Features

- 1080P HD camera  
120 degree shooting wide-angle, clear and fluid picture
- Mechanical adjustable lens  
The lens can be adjusted vertical -30 to 30 degree and horizontally -150 to 150 degree, enabling flexible shooting angle
- Audio and video integration  
Supporting Skype, Wechat, MSN and other online communication software
- Intelligent audio high-tech  
360-degree mic coverage  
256ms acoustic echo cancellation  
Full duplex  
Dynamic Noise Reduction(DNR)
- Portable external microphone and speaker  
No need driver; Clear, unmixed and not harsh sound quality

# 1 Product Overview

## 1.3 Package list

Please check whether the materials are complete according to the following table when opening the box.

No	Name	Picture	Pcs	Function Description
1	Camera		1	Conference shooting Pickup and display conference audio
2	Speaker-phone		1	
3	Jack column		1	Optional accessories and goods in kind prevail
4	USB cable		1	Speakerphone charging cable
5	Charger		1	Speakerphone charger
6	User manual		1	Help users to install, connect, and use video terminal devices

# 1 Product Overview

## 1.4 Component description

### Part 1: HD network camera

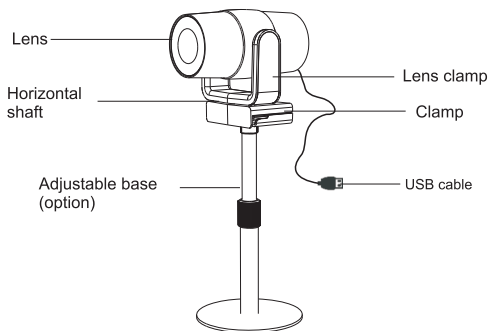

### Part 2: 2.4G wireless speakerphone

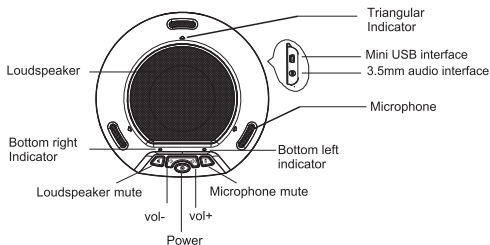

### LED Indicator

- Blue triangular Indicator: normal working status
- Blue bottom right indicator: loudspeaker mute
- Blue bottom left indicator: microphone mute
- Blinking blue bottom left indicator: volume adjustment
- Blinking orange bottom left indicator: low power



## 2 Connection

Connect HD camera to PC and long press to power on speaker phone, long press again to power off.

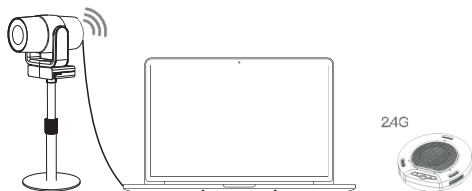
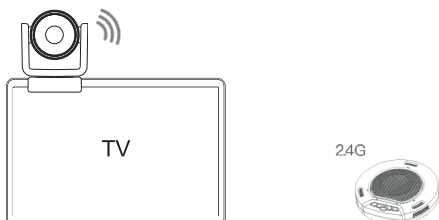

# 3 Operating Description

- Connecting USB line to computer, the following tips will appear in the lower right corner of the computer when first time using.

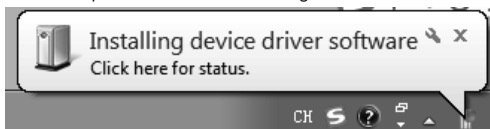

- When the device driver is installed successfully, the following prompt will appear on the computer side



- If you need to confirm whether the equipment installation is successful, turned on the computer side "computer properties" - click on the "device manager" - click on the "image equipment" appear below equipment items, after confirmed, can be used with instant messaging software.

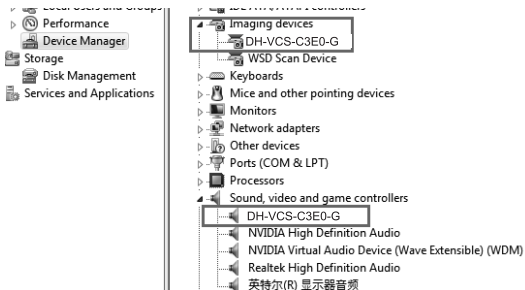

# 3 Operating Description

- Another way to check whether AUCTOPUS I-1208 is being used on the computer, click the "speaker" icon, and then it will show as following:

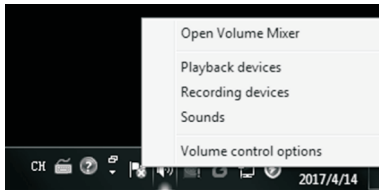

- Click "audio device" or "display devices", and then it will shows:

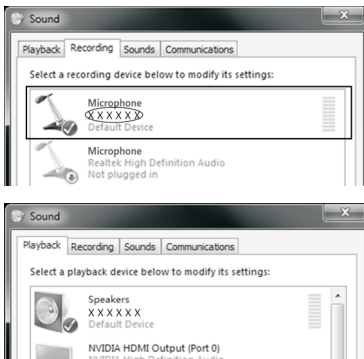

- Check whether the default device is AUCTOPUS I-1208, if not, select it as the default one and the it can work as normal.

\*\*This operation works under Win 7 and it will be some difference in other operating system. This document can be as a reference . \*\*

# 3 Operating Description

- If the color and resolution of video are found to be abnormal, it can be used in camera adjustment special software "Amcap" to check. Check the output size of the white balance and video for the corresponding values.

Check the white balance option with a default value of 4600

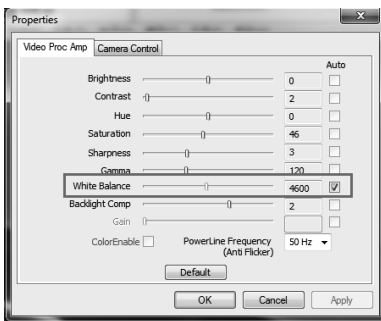

Video output size, select 1920\*1080

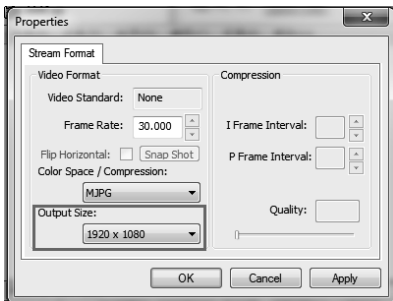

Or change the camera effect to "restore the default effect" in instant messaging software. If it still cannot fix it, please contact our after-sales service .

# 4 Specification

Specification	Description
Dimension	Camera:104*139*124mm Speakerphone:155*148*37mm
Net weight	Camera:500g Speakerphone:337g
Color	Black
Interface	USB 2.0
Battery(speakerphone)	Built-in lithium battery (7-10H)
Lens	1/2.8, fixed focus, 120 degree Angle
Sensor	Full HD CMOS sensor
Voice pickup range	3m max
Video	1920*1080
Image transmission speed	Up to 30FPS
Aperture coefficient	F2.0
Focus distance	30~300CM(Better distance)
Computer system	Windows ® 7, 10 / Mac OS X 8.1 or 10.7 or higher operating system, etc
Recommended conditions	Humidity: 20~85% condensation free Noise level: <48dB Storage temperature: -10° ~55° Reverberation time:<0.5 seconds
Certification	CE/FCC

## **FCC Statement**

Changes or modifications not expressly approved by the party responsible for compliance could void the user's authority to operate the equipment.

This equipment has been tested and found to comply with the limits for a Class B digital device, pursuant to Part 15 of the FCC Rules. These limits are designed to provide reasonable protection against harmful interference in a residential installation. This equipment generates uses and can radiate radio frequency energy and, if not installed and used in accordance with the instructions, may cause harmful interference to radio communications.

However, there is no guarantee that interference will not occur in a particular installation. If this equipment does cause harmful interference to radio or television reception, which can be determined by turning the equipment off and on, the user is encouraged to try to correct the interference by one or more of the following measures:

- Reorient or relocate the receiving antenna.
- Increase the separation between the equipment and receiver.
- Connect the equipment into an outlet on a circuit different from that to which the receiver is connected.
- Consult the dealer or an experienced radio/TV technician for help

This device complies with part 15 of the FCC rules. Operation is subject to the following two conditions (1) this device may not cause harmful interference, and (2) this device must accept any interference received, including interference that may cause undesired operation.



**INNOTRIK**

**Shenzhen Innotrik Technology Co., Ltd**

Address: Room 502 to 504, Deguanting Business Center, No.88 Xin'an 3rd Road,  
Dalang Community, Xin'an Street, Bao'an District, Shenzhen, China

P.C.: 518101

Tel: +86-755-27811125

Fax: +86-755-27811125

Website: [www.innotrik.com](http://www.innotrik.com)