



# FCC PART 73G & BETS 6

## LOW POWER FM BROADCAST STATIONS (LPFM) TEST REPORT

<b>APPLICANT</b>	RFE BROADCAST S.R.L.
	VIA MAREVITANO N. 26 FALERNA (CZ) 88042 ITALY
<b>FCC ID</b>	2ARJIDS100
<b>IC</b>	24642-DS100
<b>MODEL NUMBER</b>	DS100
<b>PRODUCT DESCRIPTION</b>	FM BROADCAST TRANSMITTER
<b>DATE SAMPLE RECEIVED</b>	12/31/2018
<b>DATE TESTED</b>	1/14/2019
<b>TESTED BY</b>	Tim Royer
<b>APPROVED BY</b>	Franklin Rose
<b>TEST RESULTS</b>	<input checked="" type="checkbox"/> PASS <input type="checkbox"/> FAIL

Report Number	Report Version	Description	Issue Date
2270UT18TestReport	Rev1	Initial Issue	01/14/2019
	Rev2	Updated Power Measurement Section	06/29/2020

**THE ATTACHED REPORT SHALL NOT BE REPRODUCED EXCEPT IN FULL WITHOUT THE WRITTEN APPROVAL OF TIMCO ENGINEERING, INC.**

## TABLE OF CONTENTS

<b>GENERAL REMARKS .....</b>	<b>1</b>
<b>GENERAL INFORMATION .....</b>	<b>2</b>
<b>RESULTS SUMMARY .....</b>	<b>3</b>
<b>RF POWER OUTPUT .....</b>	<b>4</b>
TEST DATA:    RF OUTPUT POWER, MODEL DS100 .....	5
<b>FCC PART 2.1033(C)(8).....</b>	<b>5</b>
POWER IN THE FINAL STAGE .....	5
<b>MODULATION CHARACTERISTICS .....</b>	<b>6</b>
<b>AUDIO FREQUENCY RESPONSE.....</b>	<b>7</b>
TEST DATA: AUDIO FREQUENCY RESPONSE PLOT .....	7
<b>AUDIO INPUT VS MODULATION .....</b>	<b>8</b>
TEST DATA: MODULATION LIMITING .....	9
<b>OCCUPIED BANDWIDTH &amp; EMISSION MASK.....</b>	<b>10</b>
TEST DATA:    OCCUPIED BANDWIDTH TABLE .....	11
20dB OCCUPIED BANDWIDTH PLOT LOW END OF BAND .....	11
20dB OCCUPIED BANDWIDTH PLOT MIDDLE OF BAND .....	12
20dB OCCUPIED BANDWIDTH PLOT HIGH END OF BAND .....	13
EMISSION MASK PLOT LOW END OF BAND .....	14
EMISSION MASK PLOT MIDDLE OF BAND .....	15
EMISSION MASK PLOT HIGH END OF BAND .....	16
<b>SPURIOUS EMISSIONS AT ANTENNA TERMINALS (CONDUCTED) .....</b>	<b>17</b>
<b>TEST DATA:    LOW FREQUENCY.....</b>	<b>18</b>
<b>TEST DATA:    MIDDLE FREQUENCY .....</b>	<b>18</b>
<b>TEST DATA:    HIGH FREQUENCY.....</b>	<b>19</b>
<b>FIELD STRENGTH OF SPURIOUS EMISSIONS.....</b>	<b>20</b>
<b>TEST DATA:    LOW FREQUENCY.....</b>	<b>21</b>
<b>TEST DATA:    MIDDLE FREQUENCY .....</b>	<b>21</b>
<b>TEST DATA:    HIGH FREQUENCY.....</b>	<b>22</b>
<b>FREQUENCY STABILITY .....</b>	<b>23</b>
TEST DATA: FCC FREQUENCY STABILITY TABLE .....	24
TEST DATA: FCC FREQUENCY STABILITY PLOT .....	24
TEST DATA: IC FREQUENCY STABILITY TABLE .....	25
TEST DATA: IC FREQUENCY STABILITY PLOT.....	25
<b>STATE OF THE MEASUREMENT UNCERTAINTY .....</b>	<b>26</b>
<b>EQUIPMENT LIST.....</b>	<b>27</b>

## GENERAL REMARKS

### Summary

The device under test does:

- Fulfill the general approval requirements as identified in this test report and was selected by the customer.
- Not fulfill the general approval requirements as identified in this test report

### Attestations

This equipment has been tested in accordance with the standards identified in this test report. To the best of my knowledge and belief, these tests were performed using the measurement procedures described in this report.

All instrumentation and accessories used to test products for compliance to the indicated standards are calibrated regularly in accordance with ISO 17025 requirements.

I attest that the necessary measurements were made at:

**Timco Engineering Inc.**  
**849 NW State Road 45**  
**Newberry, FL 32669**  
**Designation #: US1070**

### Tested by:



<b>Name and Title</b>	Tim Royer, Project Manager / EMC Testing Engineer
<b>Date</b>	02/11/2019

### Reviewed and Approved by:



<b>Name and Title</b>	Franklin Rose, Project Manager / EMC Testing Technician
<b>Date</b>	02/12/2019

APPLICANT: RFE BROADCAST S.R.L.  
FCC ID: 2ARJIDS100  
IC: 24642-DS100  
REPORT: 2270UT18TestReport\_Rev2

## GENERAL INFORMATION

<b>EUT Description</b>	FM BROADCAST TRANSMITTER
<b>FCC ID</b>	2ARJIDS100
<b>IC</b>	24642-DS100
<b>Model Number</b>	DS100
<b>Operating Frequency</b>	87.5- 108 MHz
<b>Test Frequencies</b>	88, 98, 108 MHz
<b>EUT Power Source</b>	<input checked="" type="checkbox"/> 110-120Vac/50- 60Hz
	<input type="checkbox"/> DC Power
	<input type="checkbox"/> Battery Operated Exclusively
<b>Test Item</b>	<input type="checkbox"/> Prototype
	<input checked="" type="checkbox"/> Pre-Production
	<input type="checkbox"/> Production
<b>Type of Equipment</b>	<input checked="" type="checkbox"/> Fixed
	<input type="checkbox"/> Mobile
	<input type="checkbox"/> Portable
<b>Antenna Connector</b>	N
<b>Test Conditions</b>	The temperature was 26°C Relative humidity of 50%.
<b>Modification to the EUT</b>	No Modification to EUT.
<b>Test Exercise</b>	The EUT was placed in continuous transmit and was operated in "Test Mode" for digital emissions tests.
<b>Applicable Standards</b>	ANSI C63.26-2015, FCC CFR 47 Part 73, BETS-6 Issue 2, Referencing ANSI/TIA 603-D:2010
<b>Test Facility</b>	Timco Engineering Inc. at 849 NW State Road 45 Newberry, FL 32669 USA. Designation #: US1070, ISED 2056A

APPLICANT: RFE BROADCAST S.R.L.  
 FCC ID: 2ARJIDS100  
 IC: 24642-DS100  
 REPORT: 2270UT18TestReport\_Rev2

## RESULTS SUMMARY

Test Description	FCC RULE PART NO.	RESULT
RF Power Output	2.1046(a), 73.267(b), 73.811(a), 73.812(a), 73.840, BETS-6 6.1.3	<b>Pass</b>
Power Into the Amplifier	2.1033(C)(8)	For Reporting Only
Modulation Characteristics	2.202(g)(III)(3), BETS-6 4.2	<b>Pass</b>
Audio Frequency Response	2.1047(a)	<b>Pass</b>
Audio Input Vs. Modulation	2.1047(b), BETS-6 4.2	<b>Pass</b>
Occupied Bandwidth	2.1049(e)(3) – (5), 73.317(b), (c), BETS-6 6.3.3	<b>Pass</b>
Spurious Emissions at Antenna Terminal	Part 2.1051 & 73.317(d), BETS-6 6.3.3	<b>Pass</b>
Field Strength of Spurious Radiation	Part 2.1053(a) & 73.317(d), BETS-6 6.3.3	<b>Pass</b>
Frequency Stability	Part 2.1055(a)(3), Part 73.1545(b), BETS-6 6.2.2	<b>Pass</b>

## RF POWER OUTPUT

**Rule Part No.:** Part 2.1046(a), Part 73.267(b), 73.811(a), 73.812(a), BETS-6 6.1.3

**Test Requirements:** Part 73.267(c), 73.811(a), 73.812(a)

(c) *Indirect method.* The operating power is determined by the indirect method by applying an appropriate factor to the input power to the last radio-frequency power amplifier stage of the transmitter, using the following formula:

$$\text{Transmitter output power} = E_p \times I_p \times F$$

Where:

$E_p$  = DC input voltage of final radio stage.

$I_p$  = Total DC input current of final radio stage.

$F$  = Efficiency factor.

### §73.811 LPFM power and antenna height requirements.

(a) *Maximum facilities.* LPFM stations will be authorized to operate with maximum facilities of 100 watts ERP at 30 meters HAAT. An LPFM station with a HAAT that exceeds 30 meters will not be permitted to operate with an ERP greater than that which would result in a 60 dBu contour of 5.6 kilometers. In no event will an ERP less than one watt be authorized. No facility will be authorized in excess of one watt ERP at 450 meters HAAT.

### §73.812 Rounding of power and antenna heights.

(a) Effective radiated power (ERP) will be rounded to the nearest watt on LPFM authorizations.

**Test Requirements:** BETS-6 6.1.3

#### 6.1.3 Standard

The standard rating of power output for the transmitting equipment shall be as specified by the individual manufacturer. The transmitting equipment shall be capable of being adjusted to deliver the rated power output when the AC input voltage varies by 5% from the rated value.

**Method of Measurement:** ANSI C63.26

#### Test Setup Diagram:

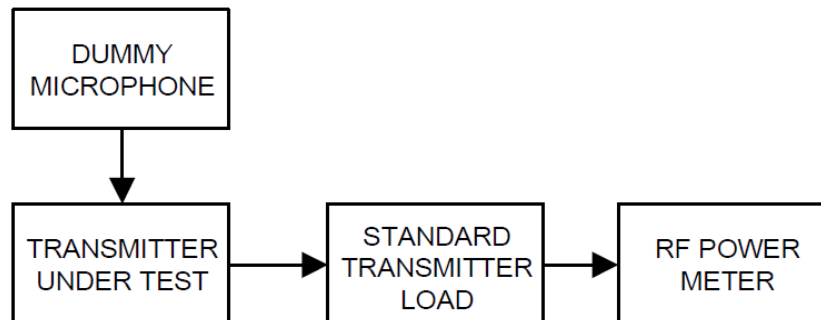

APPLICANT: RFE BROADCAST S.R.L.  
 FCC ID: 2ARJIDS100  
 IC: 24642-DS100  
 REPORT: 2270UT18TestReport\_Rev2

## RF POWER OUTPUT

### Test Data: RF Output Power, Model DS100

Frequency (MHz)	Stable over Input Voltage Variation (+/- %)	Output Power (W)	Min Power 90% (W)	Max Power 105% (W)
88.0	5%	100	90	105
98.0	5%	100	90	105
108.0	5%	100	90	105

Efficiency Factor:  $100 / (200) = 50\%$

### FCC Part 2.1033(C)(8)

(8) The dc voltages applied to and dc currents into the several elements of the final radio frequency amplifying device for normal operation over the power range.

### Power In the Final Stage

AC Apparent Power Consumption: 100VA @ 50W, 200VA @ 100W, 450VA @ 300W, 750VA @ 500W, 1400VA @ 1000W.

Power at Final Stage:  $(250.0 \text{ VDC}) (0.8 \text{ A}) = \mathbf{200 \text{ Watts}}$

## MODULATION CHARACTERISTICS

**Rule Part No.:** Part 2.202(g)(III)(3) "Sound Broadcasting", BETS-6 4.2

**Test Requirements:** Part 2.202(g)(III)(3)

Description of emission	Necessary bandwidth		Designation of emission
	Formula	Sample calculation	
<b>III-A. FREQUENCY MODULATION</b>			
3. Sound Broadcasting			
Sound broadcasting	$B_n = 2M + 2DK$ , K = 1 (typically)	Monaural, D = 75,000 Hz, M = 15,000, Bandwidth: 18,000 Hz = 180 kHz	180KF3E

**Test Requirements:** BETS-6 4.2

### 4.2 Type of Emission

The designation of modulation and emission refers to the manner in which the carrier is modulated and transmitted. The transmitting equipment shall produce F3EGN emission for monophonic operation and F8EHF emission for stereophonic operation. The transmitting equipment shall be capable of operating with a frequency deviation of  $\pm 75$  kHz, which is equivalent to 100% modulation.

**Type of Emission:** **180KF3E**

$$B_n = 2M + 2DK$$

$$B_n = 2(15K) + 2(75K)(1) = 180K$$

Where:

M = 10 (Modulation Frequency, kHz)

D = 75 (Peak Deviation, kHz)

K = 1 (constant value)



# AUDIO FREQUENCY RESPONSE

**Rule Part No.:** FCC Part 2.1047(a), (b)

**Test Requirements:** FCC Part 2.1047(a)

**§2.1047 Measurements required: Modulation characteristics.**

(a) *Voice modulated communication equipment.* A curve or equivalent data showing the frequency response of the audio modulating circuit over a range of 100 to 5000 Hz shall be submitted. For equipment required to have an audio low-pass filter, a curve showing the frequency response of the filter, or of all circuitry installed between the modulation limiter and the modulated stage shall be submitted.

**Method of Measurement:** ANSI C63.26 s. 5.3.3

## Test Setup Diagram:

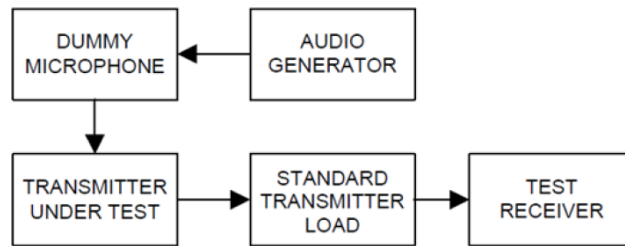
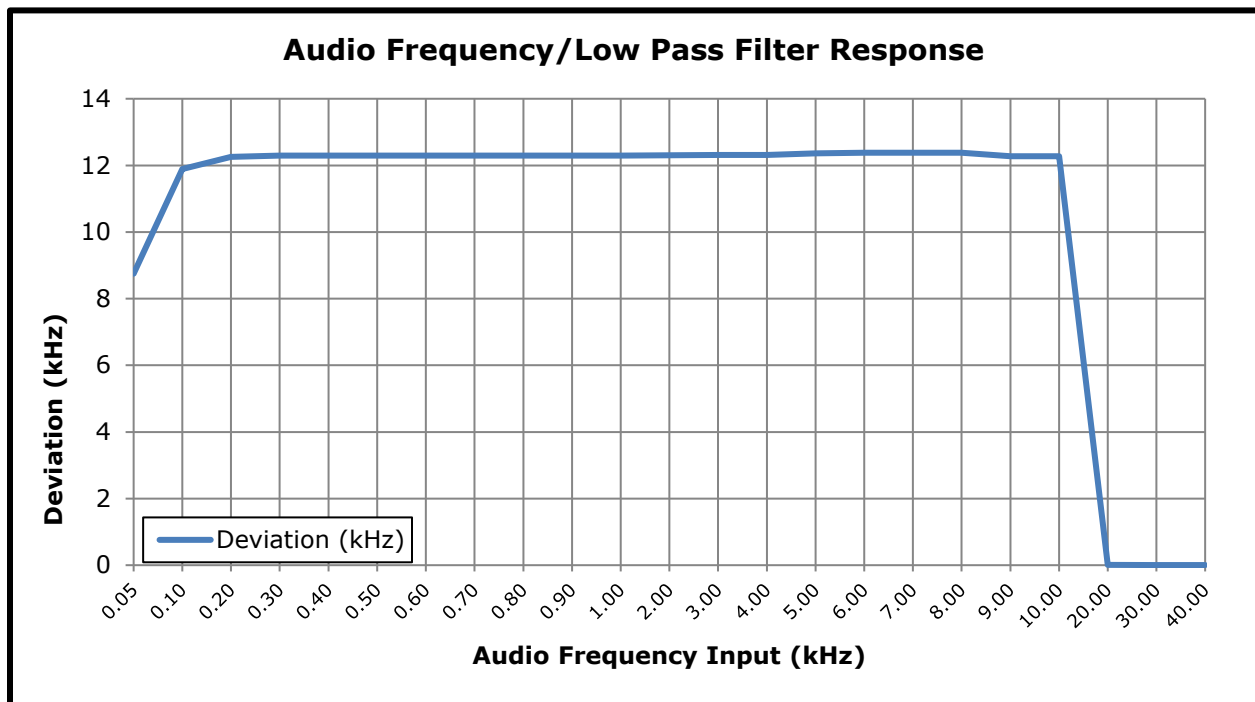

Figure 3—Equipment set-up audio frequency response (constant input)

## Test Data: Audio Frequency Response Plot



## AUDIO INPUT VS MODULATION

**Rule Part No.:** FCC Part 2.1047(b), BETS-6 4.2

**Test Requirements:** FCC Part 2.1047(b)

(b) *Equipment which employs modulation limiting.* A curve or family of curves showing the percentage of modulation versus the modulation input voltage shall be supplied. The information submitted shall be sufficient to show modulation limiting capability throughout the range of modulating frequencies and input modulating signal levels employed.

**Test Requirements:** BETS-6 4.2

### 4.2 Type of Emission

The designation of modulation and emission refers to the manner in which the carrier is modulated and transmitted. The transmitting equipment shall produce F3EGN emission for monophonic operation and F8EHF emission for stereophonic operation. The transmitting equipment shall be capable of operating with a frequency deviation of  $\pm 75$  kHz, which is equivalent to 100% modulation.

**Method of Measurement:** ANSI C63.26 s. 5.3.2

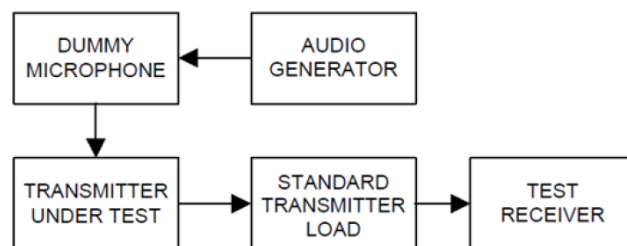
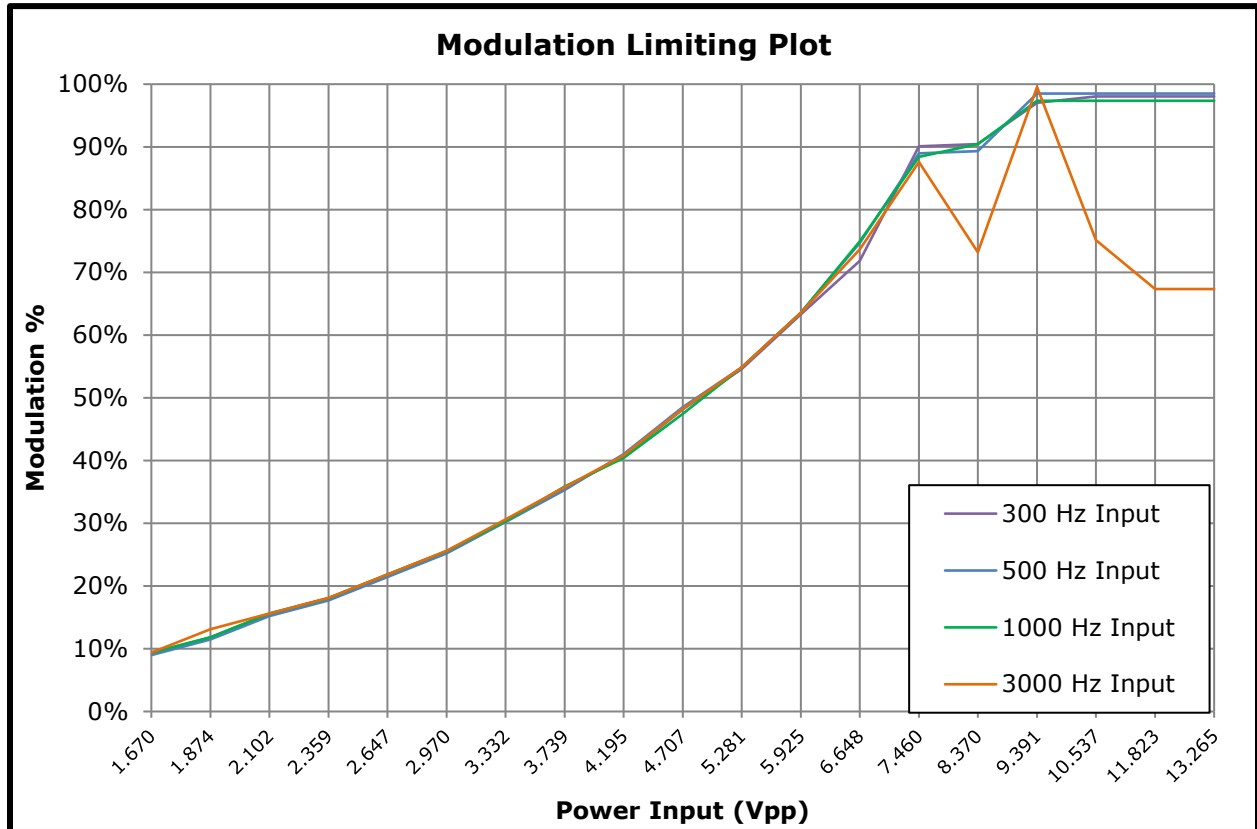

Figure 3—Equipment set-up audio frequency response (constant input)

# AUDIO INPUT VERSUS MODULATION

Test data: Modulation Limiting



## OCCUPIED BANDWIDTH & EMISSION MASK

**Rule Part No.:** FCC Part 2.1049(e)(3) – (5), Part 73.317(b), (c), BETS-6 6.3.3

**Requirement:** FCC 2.1049(e)(3)-(5)

**§2.1049 Measurements required: Occupied bandwidth.**

(e) Transmitters for use in the Radio Broadcast Services:

(3) FM broadcast transmitter not used for multiplex operation—when modulated 85 percent by a 15 kHz input signal.

(4) FM broadcast transmitters for multiplex operation under Subsidiary Communication Authorization (SCA)—when carrier is modulated 70 percent by a 15 kHz main channel input signal, and modulated an additional 15 percent simultaneously by a 67 kHz subcarrier (unmodulated).

(5) FM broadcast transmitter for stereophonic operation—when modulated by a 15 kHz input signal to the main channel, a 15 kHz input signal to the stereophonic subchannel, and the pilot subcarrier simultaneously. The input signals to the main channel and stereophonic subchannel each shall produce 38 percent modulation of the carrier. The pilot subcarrier should produce 9 percent modulation of the carrier.

**Requirement:** FCC 73.317(b), (c)

(b) Any emission appearing on a frequency removed from the carrier by between 120 kHz and 240 kHz inclusive must be attenuated at least 25 dB below the level of the unmodulated carrier. Compliance with this requirement will be deemed to show the occupied bandwidth to be 240 kHz or less.

(c) Any emission appearing on a frequency removed from the carrier by more than 240 kHz and up to and including 600 kHz must be attenuated at least 35 dB below the level of the unmodulated carrier.

**Requirement:** BETS-6 6.3.3

### 6.3.3 Standard

Spurious emissions of the transmitting equipment shall not exceed the values given below:

Spurious Emission	Maximum Value
Between 120 kHz and 240 kHz from the carrier frequency	-25 dB <input type="text"/>
More than 240 kHz and up to and including 600 kHz from the carrier frequency	-35 dB*
More than 600 kHz from the carrier frequency, whichever is the stronger	-(43 + 10 log P) <input type="text"/> or -80 dB* P = power in watts

### Test Setup Diagram:

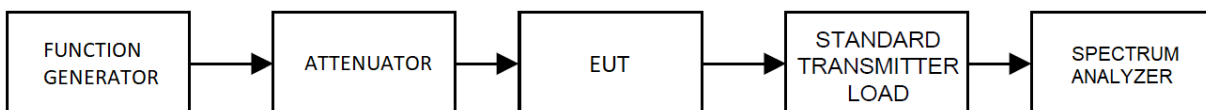

APPLICANT: RFE BROADCAST S.R.L.  
 FCC ID: 2ARJIDS100  
 IC: 24642-DS100  
 REPORT: 2270UT18TestReport\_Rev2

### Test Data: Occupied Bandwidth Table

Frequency (MHz)	20dB OBW (kHz)
88	125.75
98	119.23
108	107.94

### 20dB OCCUPIED BANDWIDTH PLOT Low End of band

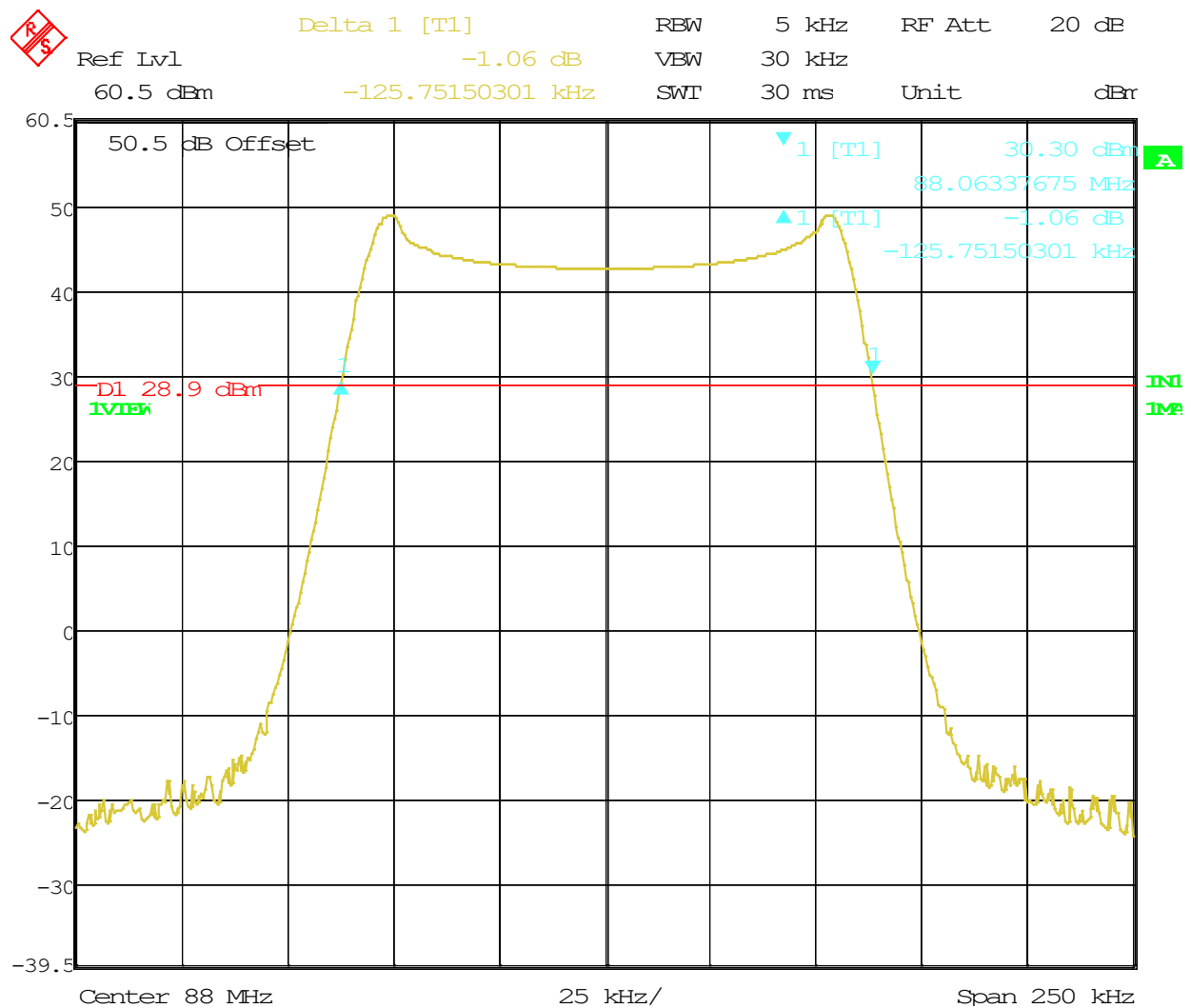

Date: 1.JAN.1997 01:23:10

APPLICANT: RFE BROADCAST S.R.L.  
 FCC ID: 2ARJIDS100  
 IC: 24642-DS100  
 REPORT: 2270UT18TestReport\_Rev2

### 20dB OCCUPIED BANDWIDTH PLOT Middle of band

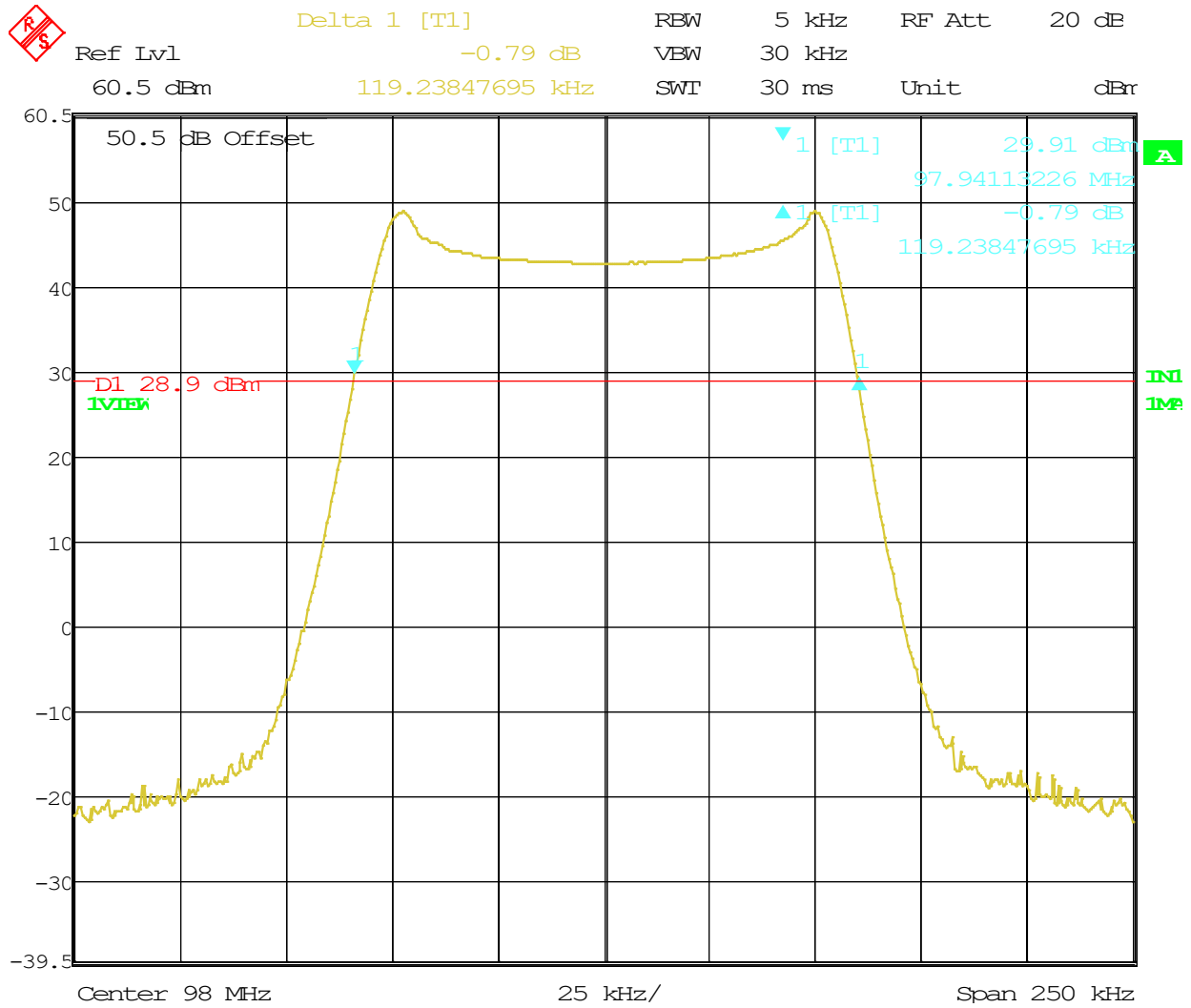

Date: 1.JAN.1997 01:45:52

## 20dB OCCUPIED BANDWIDTH PLOT High End of band

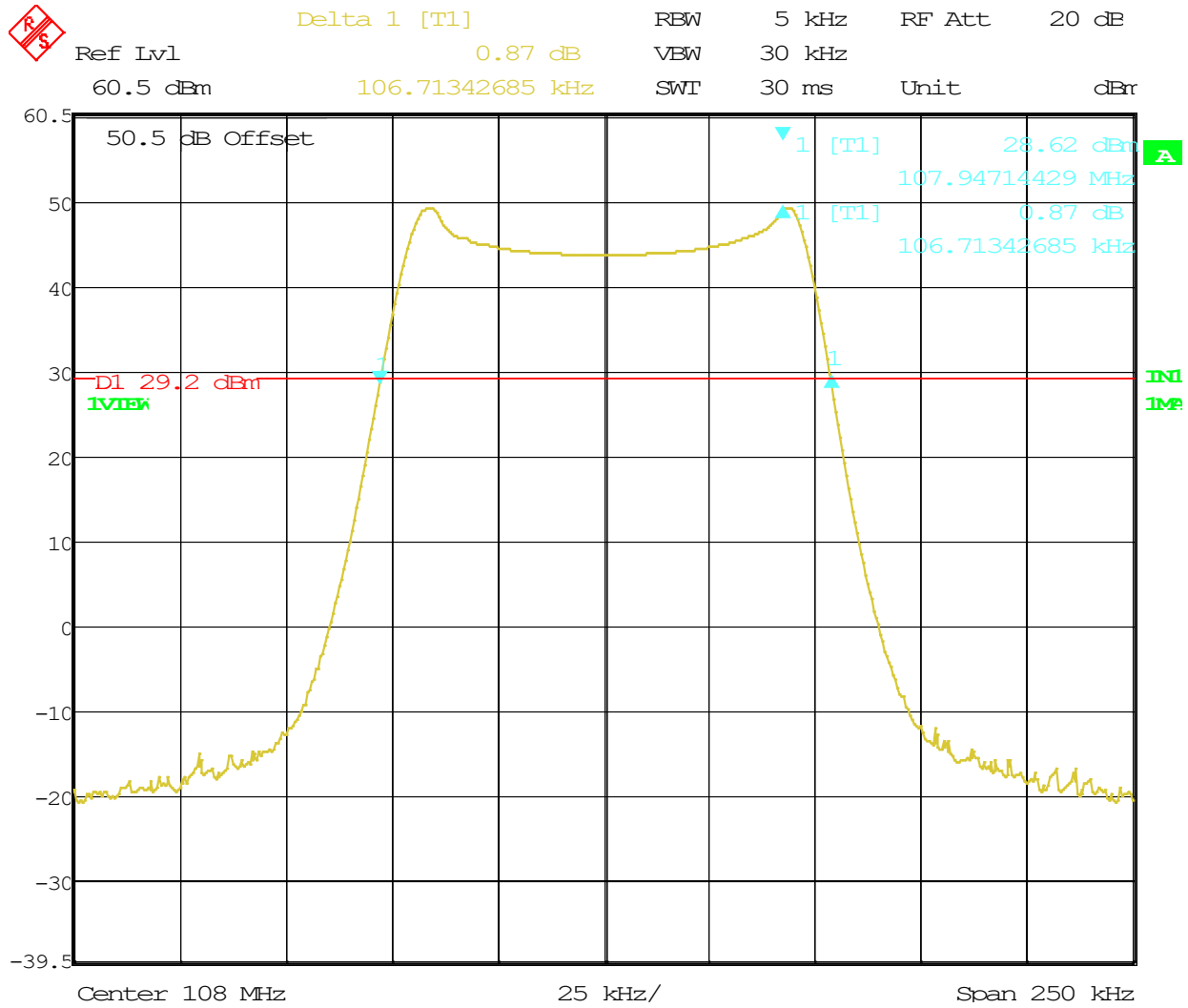

Date: 1.JAN.1997 01:53:46

APPLICANT: RFE BROADCAST S.R.L.  
 FCC ID: 2ARJIDS100  
 IC: 24642-DS100  
 REPORT: 2270UT18TestReport\_Rev2

# EMISSION MASK PLOT Low End of band

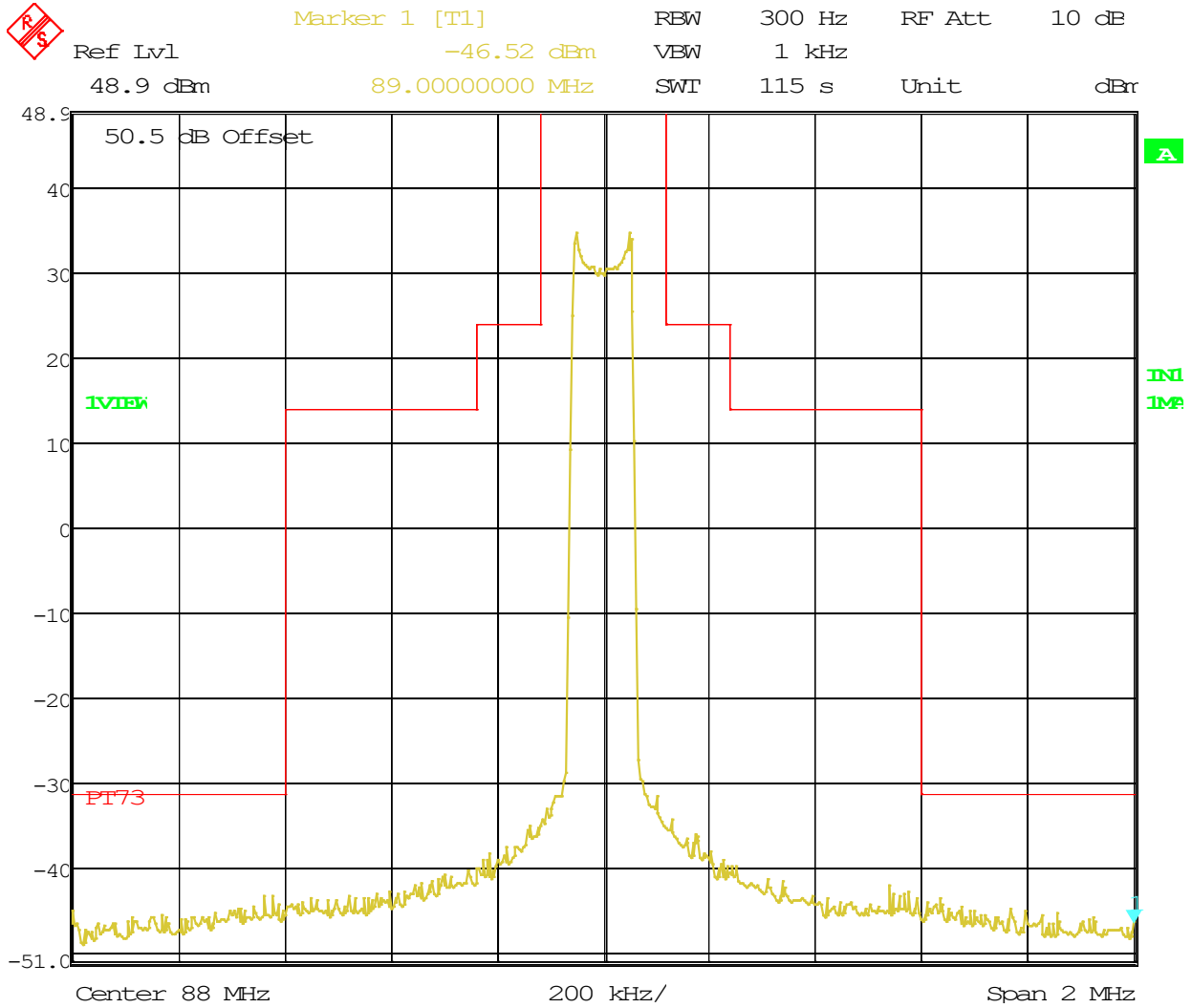

Date: 1.JAN.1997 01:20:48

APPLICANT: RFE BROADCAST S.R.L.  
FCC ID: 2ARJIDS100  
IC: 24642-DS100  
REPORT: 2270UT18TestReport\_Rev2



### EMISSION MASK PLOT Middle of band

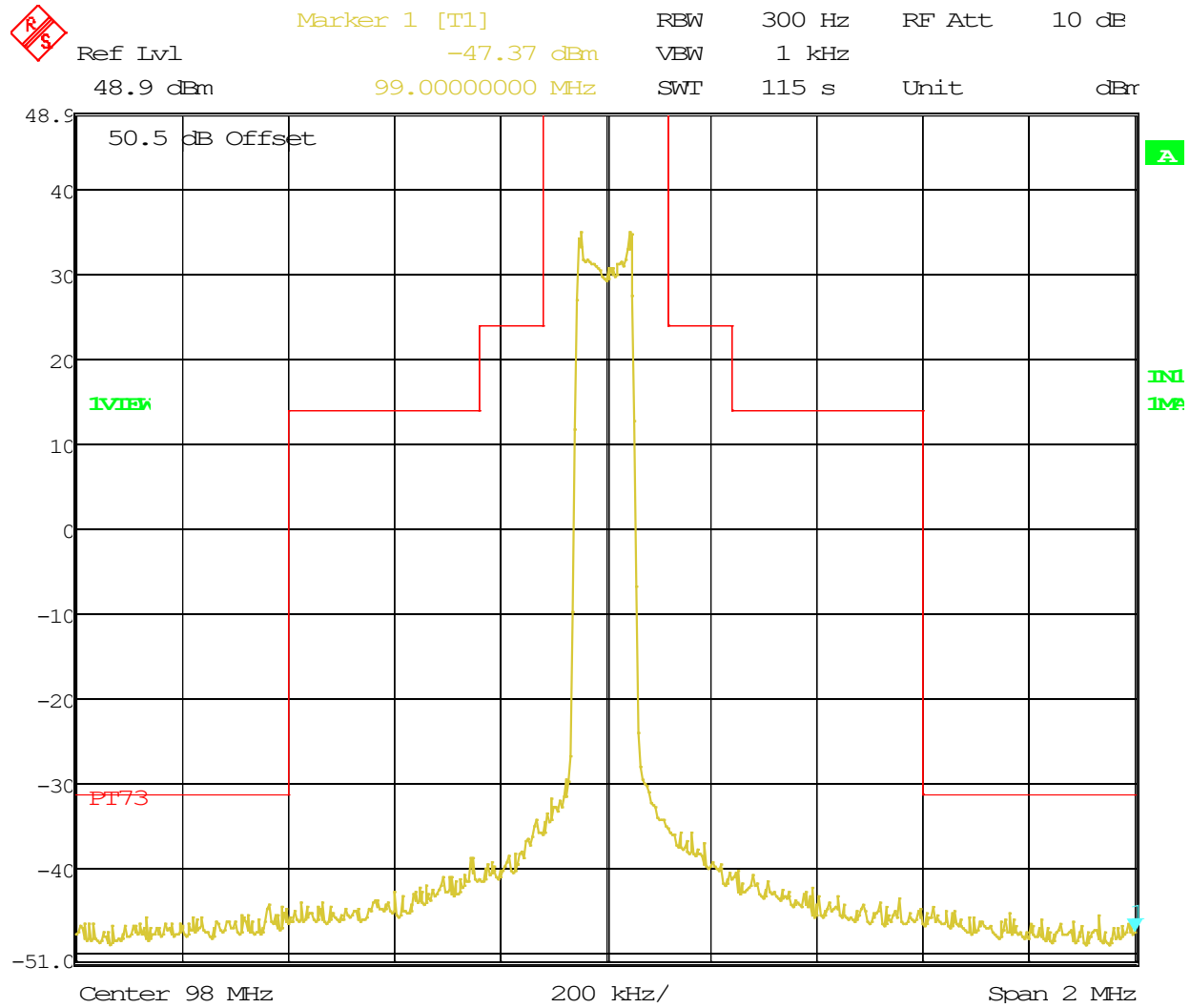

Date: 1.JAN.1997 01:10:49

APPLICANT: RFE BROADCAST S.R.L.  
 FCC ID: 2ARJIDS100  
 IC: 24642-DS100  
 REPORT: 2270UT18TestReport\_Rev2

### EMISSION MASK PLOT High End of band

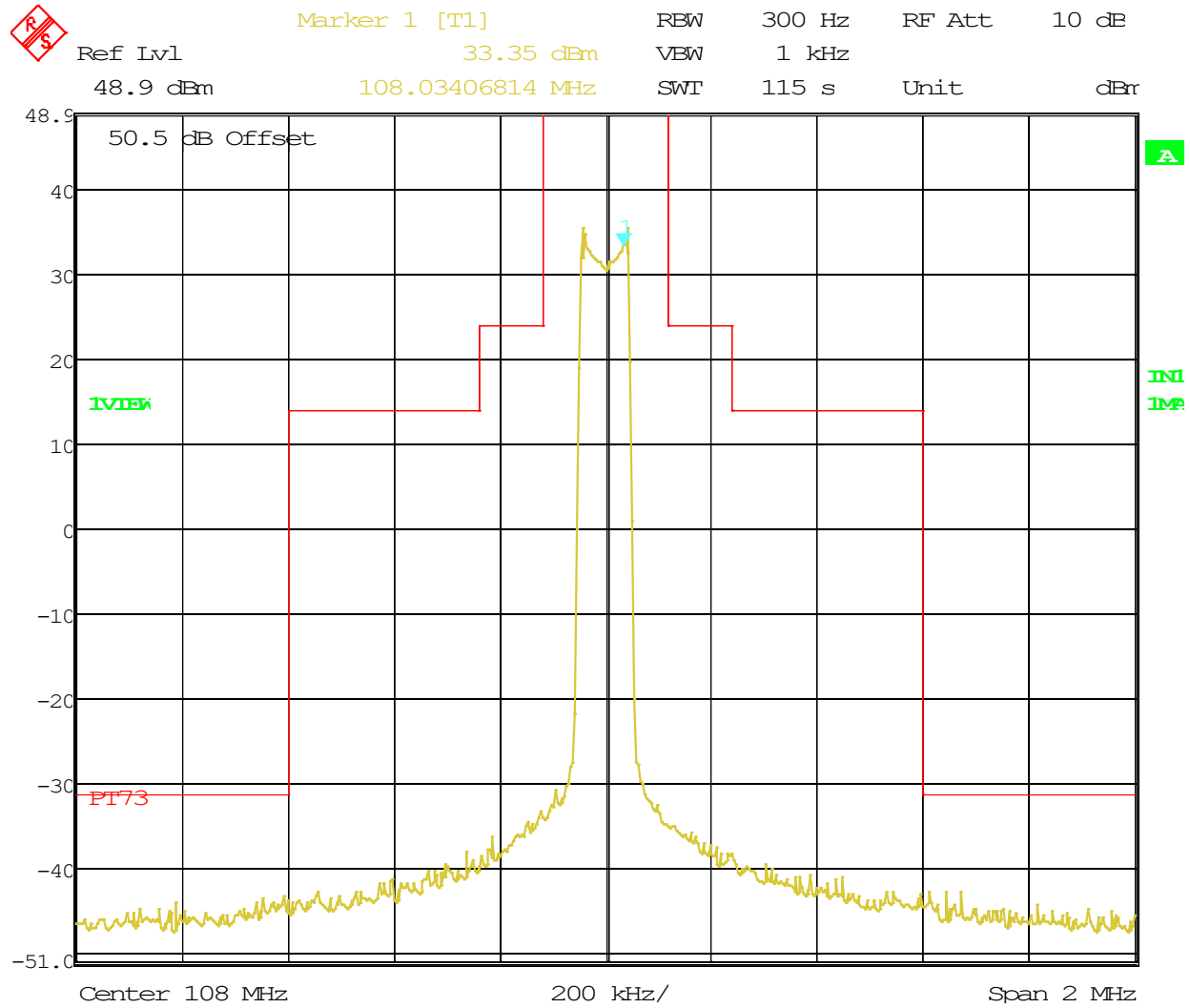

Date: 1.JAN.1997 01:05:38

APPLICANT: RFE BROADCAST S.R.L.  
 FCC ID: 2ARJIDS100  
 IC: 24642-DS100  
 REPORT: 2270UT18TestReport\_Rev2

## SPURIOUS EMISSIONS AT ANTENNA TERMINALS (CONDUCTED)

**Rule Part No.:** Part 2.1051 & 73.317(d), BETS-6 6.3.3

**Test Requirements:** 73.317 (d)

(d) Any emission appearing on a frequency removed from the carrier by more than 600 kHz must be attenuated at least  $43 + 10 \log_{10}(\text{Power, in watts})$  dB below the level of the unmodulated carrier, or 80 dB, whichever is the lesser attenuation.

**Test Requirements:** BETS-6 6.3.3

More than 600 kHz from the carrier frequency, whichever is the stronger	$-(43 + 10 \log P)$ <input type="text"/> or -80 dB* P = power in watts
---	--

$$43 + 10 * \log (620) = 59.56 \text{ dB} < 80 \text{ dB}$$

**Antenna Conducted Emissions:** The RBW = 100 kHz, VBW = 300 kHz and the span set to 10.0 MHz and the spectrum was scanned from 30 MHz to the 10<sup>th</sup> harmonic of the fundamental. Above 1 GHz the resolution bandwidth was 1 MHz and the VBW = 3 MHz and the span to 50 MHz.

### Method of Measuring Conducted Spurious Emissions

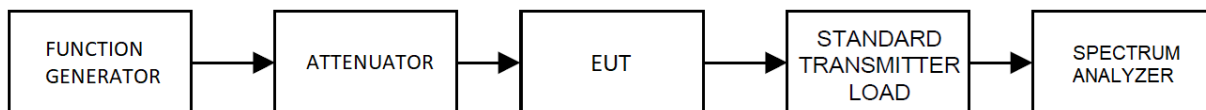

## SPURIOUS EMISSIONS AT ANTENNA TERMINALS (CONDUCTED)

### Test Data: Low Frequency

Spurious Conducted Emissions		(dBm)	(Watts)	Limit (dBc)
		49.33	85.70	62.33
		Frequency	Peak (dBm)	Margin (dB)
(fundamental)		88.000	0.00	0.00
2nd Harmonic		176.000	-29.64	16.64
3rd Harmonic		264.000	-29.49	16.49
4th Harmonic	*	352.000	-45.38	32.38
5th Harmonic		440.000	-39.86	26.86
6th Harmonic		528.000	-32.45	19.45
7th Harmonic		616.000	-38.96	25.96
8th Harmonic	*	704.000	-43.71	30.71
9th Harmonic	*	792.000	-40.22	27.22
10th Harmonic	*	880.000	-43.71	30.71

\* Indicates Noise Floor of Measurement

### Test Data: Middle Frequency

Spurious Conducted Emissions		(dBm)	(Watts)	Limit (dBc)
		48.53	71.29	61.53
		Frequency	Peak (dBm)	Margin (dB)
(fundamental)		98.000	0.00	0.00
2nd Harmonic		196.000	-28.37	15.37
3rd Harmonic		294.000	-28.22	15.22
4th Harmonic	*	392.000	-44.11	31.11
5th Harmonic		490.000	-38.59	25.59
6th Harmonic	*	588.000	-31.18	18.18
7th Harmonic		686.000	-37.69	24.69
8th Harmonic	*	784.000	-42.44	29.44
9th Harmonic		882.000	-38.95	25.95
10th Harmonic	*	980.000	-42.44	29.44

\* Indicates Noise Floor of Measurement

**SPURIOUS EMISSIONS AT ANTENNA TERMINALS (CONDUCTED)**

**Test Data: High Frequency**

Spurious Conducted Emissions		(dBm)	(Watts)	Limit (dBc)
		47.65	58.21	60.65
		Frequency	Peak (dBm)	Margin (dB)
(fundamental)		108.000	0.00	0.00
2nd Harmonic		216.000	-43.84	30.84
3rd Harmonic		324.000	-25.99	12.99
4th Harmonic		432.000	-43.35	30.35
5th Harmonic		540.000	-39.78	26.78
6th Harmonic		648.000	-43.10	30.10
7th Harmonic		756.000	-41.54	28.54
8th Harmonic		864.000	-43.77	30.77
9th Harmonic	*	972.000	-45.79	32.79
10th Harmonic	*	1080.000	-45.79	32.79

\* Indicates Noise Floor of Measurement

## FIELD STRENGTH OF SPURIOUS EMISSIONS

**Rule Parts. No.:** Part 2.1053(a) & 73.317 (d), BETS-6 6.3.3

**Test Requirements:** 73.317 (d)

(d) Any emission appearing on a frequency removed from the carrier by more than 600 kHz must be attenuated at least  $43 + 10 \log_{10}(\text{Power, in watts})$  dB below the level of the unmodulated carrier, or 80 dB, whichever is the lesser attenuation.

**Test Requirements:** BETS-6 6.3.3

More than 600 kHz from the carrier frequency, whichever is the stronger

$-(43 + 10 \log P)$  :-  
or  $-80 \text{ dB}^*$   
P = power in watts

$$43 + 10 \cdot \log(620) = 59.56 \text{ dB} < 80 \text{ dB}$$

### Test Site Setup:

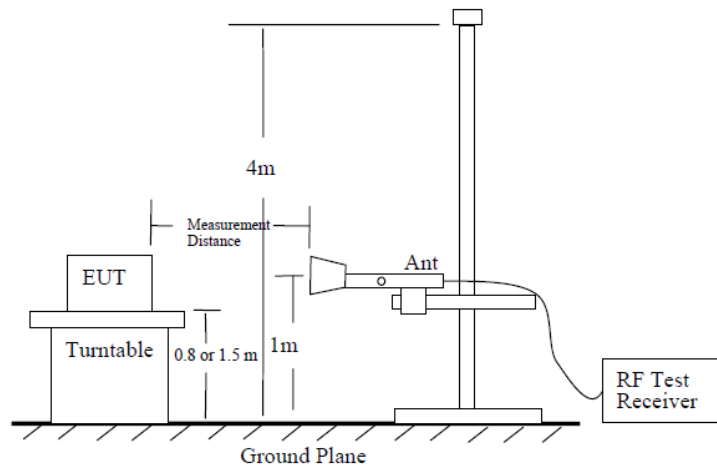

### EUT Orientation(s):

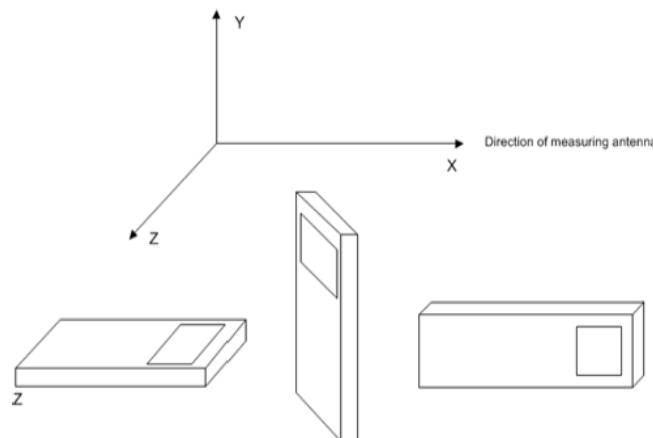

APPLICANT: RFE BROADCAST S.R.L.  
FCC ID: 2ARJIDS100  
IC: 24642-DS100  
REPORT: 2270UT18TestReport\_Rev2

## FIELD STRENGTH OF SPURIOUS EMISSIONS

**Note:** The tabulated data shows the results of the radiated field strength emissions test. The spectrum was scanned from the lowest frequency generated internally to at least the tenth harmonic of the fundamental. This test was conducted in accordance with the standard listed above using the substitution method. Measurements were made at the test site of TIMCO ENGINEERING, INC. located at 849 NW State Road 45, Newberry, FL 32669. The measurements below represent the worst case of all the frequencies tested.

**Note:** Six (6) or more of the highest emissions of each worst-case operational mode of the EUT are represented below. Emissions 20 dB below the limit were not required to be reported.

### Test Data: Low Frequency

Power Output		Limit								
dBm	Watts	dBc	dBm							
49.33	85.70	62.33	-13.00							
Tuned Frequency (MHz)	Emission Frequency (MHz)	Meter Reading (dBµV)	Antenna Polarity	Coax Loss (dB)	Correction Factor (dB/m)	Distance (m)	Field Strength (dBµV/m)	ERP (dBm)	Limit (dBm)	Margin (dB)
88.00	264.00	23.56	H	2.03	12.80	3.00	38.39	-58.98	-13.00	45.98
88.00	264.00	24.73	V	2.03	12.80	3.00	39.56	-57.81	-13.00	44.81
88.00	352.00	16.83	H	2.12	14.80	3.00	33.75	-63.63	-13.00	50.63
88.00	352.00	18.01	V	2.12	14.80	3.00	34.93	-62.45	-13.00	49.45
88.00	440.00	13.39	H	2.40	16.20	3.00	31.99	-65.39	-13.00	52.39
88.00	440.00	18.08	V	2.40	16.20	3.00	36.68	-60.70	-13.00	47.70
88.00	528.00	13.65	H	2.76	17.20	3.00	33.61	-63.77	-13.00	50.77
88.00	528.00	17.02	V	2.76	17.20	3.00	36.98	-60.40	-13.00	47.40
88.00	616.00	13.65	H	2.90	18.80	3.00	35.35	-62.03	-13.00	49.03
88.00	616.00	17.02	V	2.90	18.80	3.00	38.72	-58.66	-13.00	45.66
88.00	704.00	13.65	H	3.11	21.30	3.00	38.06	-59.32	-13.00	46.32
88.00	704.00	17.02	V	3.11	21.30	3.00	41.43	-55.95	-13.00	42.95
88.00	792.00	13.65	H	3.32	21.30	3.00	38.27	-59.11	-13.00	46.11
88.00	792.00	17.02	V	3.32	21.30	3.00	41.64	-55.74	-13.00	42.74
88.00	880.00	22.10	H	3.54	21.70	3.00	47.34	-50.04	-13.00	37.04
88.00	880.00	17.02	V	3.54	21.70	3.00	42.26	-55.12	-13.00	42.12

### Test Data: Middle Frequency

Tuned Frequency (MHz)	Emission Frequency (MHz)	Meter Reading (dBµV)	Antenna Polarity	Coax Loss (dB)	Correction Factor (dB/m)	Distance (m)	Field Strength (dBµV/m)	ERP (dBm)	Limit (dBm)	Margin (dB)
98.00	294.00	22.10	V	2.08	13.70	3.00	37.88	-59.50	-13.00	46.50
98.00	294.00	19.02	H	2.08	13.70	3.00	34.80	-62.58	-13.00	49.58
98.00	392.00	18.73	V	2.27	15.10	3.00	36.10	-61.28	-13.00	48.28
98.00	392.00	19.16	H	2.27	15.10	3.00	36.53	-60.85	-13.00	47.85
98.00	490.00	17.38	V	2.62	17.80	3.00	37.80	-59.58	-13.00	46.58
98.00	490.00	16.60	H	2.62	17.80	3.00	37.02	-60.36	-13.00	47.36
98.00	588.00	18.94	V	2.87	18.90	3.00	40.71	-56.67	-13.00	43.67
98.00	588.00	19.07	H	2.87	18.90	3.00	40.84	-56.54	-13.00	43.54
98.00	686.00	13.94	V	3.06	20.80	3.00	37.80	-59.58	-13.00	46.58
98.00	686.00	14.27	H	3.06	20.80	3.00	38.13	-59.25	-13.00	46.25
98.00	784.00	13.94	V	3.30	21.60	3.00	38.84	-58.53	-13.00	45.53
98.00	784.00	14.27	H	3.30	21.60	3.00	39.17	-58.20	-13.00	45.20
98.00	882.00	19.98	V	3.54	21.50	3.00	45.02	-52.35	-13.00	39.35
98.00	882.00	20.33	H	3.54	21.50	3.00	45.37	-52.00	-13.00	39.00
98.00	980.00	21.73	V	3.69	23.60	3.00	49.02	-48.36	-13.00	35.36
98.00	980.00	17.89	H	3.69	23.60	3.00	45.18	-52.20	-13.00	39.20

## FIELD STRENGTH OF SPURIOUS EMISSIONS

### Test Data: High Frequency

Tuned Frequency (MHz)	Emission Frequency (MHz)	Meter Reading (dBµV)	Antenna Polarity	Coax Loss (dB)	Correction Factor (dB/m)	Distance (m)	Field Strength (dBµV/m)	ERP (dBm)	Limit (dBm)	Margin (dB)
108.00	216.00	27.26	H	1.67	10.70	3.00	39.63	-57.75	-13.00	44.75
108.00	216.00	26.46	V	1.67	10.70	3.00	38.83	-58.55	-13.00	45.55
108.00	324.00	22.14	H	2.09	13.80	3.00	38.03	-59.35	-13.00	46.35
108.00	324.00	22.28	V	2.09	13.80	3.00	38.17	-59.21	-13.00	46.21
108.00	432.00	20.77	H	2.38	16.90	3.00	40.05	-57.32	-13.00	44.32
108.00	432.00	21.99	V	2.38	16.90	3.00	41.27	-56.10	-13.00	43.10
108.00	540.00	18.21	H	2.78	17.30	3.00	38.29	-59.09	-13.00	46.09
108.00	540.00	15.92	V	2.78	17.30	3.00	36.00	-61.38	-13.00	48.38
108.00	648.00	18.59	H	2.96	20.20	3.00	41.75	-55.63	-13.00	42.63
108.00	648.00	15.92	V	2.96	20.20	3.00	39.08	-58.30	-13.00	45.30
108.00	756.00	18.59	H	3.23	20.90	3.00	42.72	-54.66	-13.00	41.66
108.00	756.00	15.92	V	3.23	20.90	3.00	40.05	-57.33	-13.00	44.33
108.00	864.00	18.59	H	3.50	22.70	3.00	44.79	-52.59	-13.00	39.59
108.00	864.00	25.12	V	3.50	22.70	3.00	51.32	-46.06	-13.00	33.06
108.00	972.00	22.59	H	3.66	23.60	3.00	49.85	-47.53	-13.00	34.53
108.00	972.00	19.76	V	3.66	23.60	3.00	47.02	-50.36	-13.00	37.36
108.00	1080.00	19.31	H	3.90	27.70	3.00	50.91	-46.47	-13.00	33.47
108.00	1080.00	19.54	V	3.90	27.70	3.00	51.14	-46.24	-13.00	33.24



## FREQUENCY STABILITY

**Rule Parts. No.:** Part 2.1055(a)(3), Part 73.1545(b), BETS-6 6.2.2

**Test Requirements:** Part 2.1055(A) (3)

### §2.1055 Measurements required: Frequency stability.

(a) The frequency stability shall be measured with variation of ambient temperature as follows:

(1) From  $-30^{\circ}$  to  $+50^{\circ}$  centigrade for all equipment except that specified in paragraphs (a) (2) and (3) of this section.

(3) From  $0^{\circ}$  to  $+50^{\circ}$  centigrade for equipment to be licensed for use in the Radio Broadcast Services under part 73 of this chapter.

**Test Requirements:** Part 73.1545(b)

### §73.1545 Carrier frequency departure tolerances.

(b) *FM stations.* (1) The departure of the carrier or center frequency of an FM station with an authorized transmitter output power more than 10 watts may not exceed  $\pm 2000$  Hz from the assigned frequency.

**Test Requirements:** BETS-6 6.2.2

## 6.2 Carrier Frequency Stability

### 6.2.1 Definition

The carrier frequency stability is the ability of the transmitting equipment to maintain a mean test frequency.

### 6.2.2 Method of Measurement

After a warm-up period of one hour at rated AC input voltage, measure the frequency of the carrier at one minute intervals during a period of fifteen minutes. From these measurements, determine a mean test frequency. Then, measure and record the operating frequency at a temperature of  $5^{\circ}\text{C}$  at 85, 100 and 115% of the rated AC supply voltage. Repeat for a temperature of  $45^{\circ}\text{C}$ .

Where it is not practical to subject the complete transmitting equipment to the specified test conditions, it is permissible to isolate and separately measure the stability of the frequency-determining elements of the transmitting equipment under the specified conditions.

### 6.2.3 Standard

The frequency of the carrier shall remain within  $\pm 1$  kHz of the mean test frequency.

**Method of Measurements:** ANSI C63.26 5.6

APPLICANT: RFE BROADCAST S.R.L.  
FCC ID: 2ARJIDS100  
IC: 24642-DS100  
REPORT: 2270UT18TestReport\_Rev2

### Test Data: FCC Frequency Stability Table

FCC Part 73 Limit	2	+/- kHz
FCC Part 73 Lower Limit	108.005671	MHz
FCC Part 73 Upper Limit	108.009671	MHz
Rated Supply Voltage	110.0	<input checked="" type="radio"/> AC <input type="radio"/> DC
Temperature / Voltage Variation		
Temperature (°C)	Supplied Voltage (V)	Frequency (MHz)
0	110.0	108.007510
+10	110.0	108.007671
+20 (reference)	110.0	108.007671
+20	93.5	108.007671
+20	126.5	108.007671
+30	110.0	108.007671
+40	110.0	108.007808
+50	110.0	108.007682

### Test Data: FCC Frequency Stability Plot

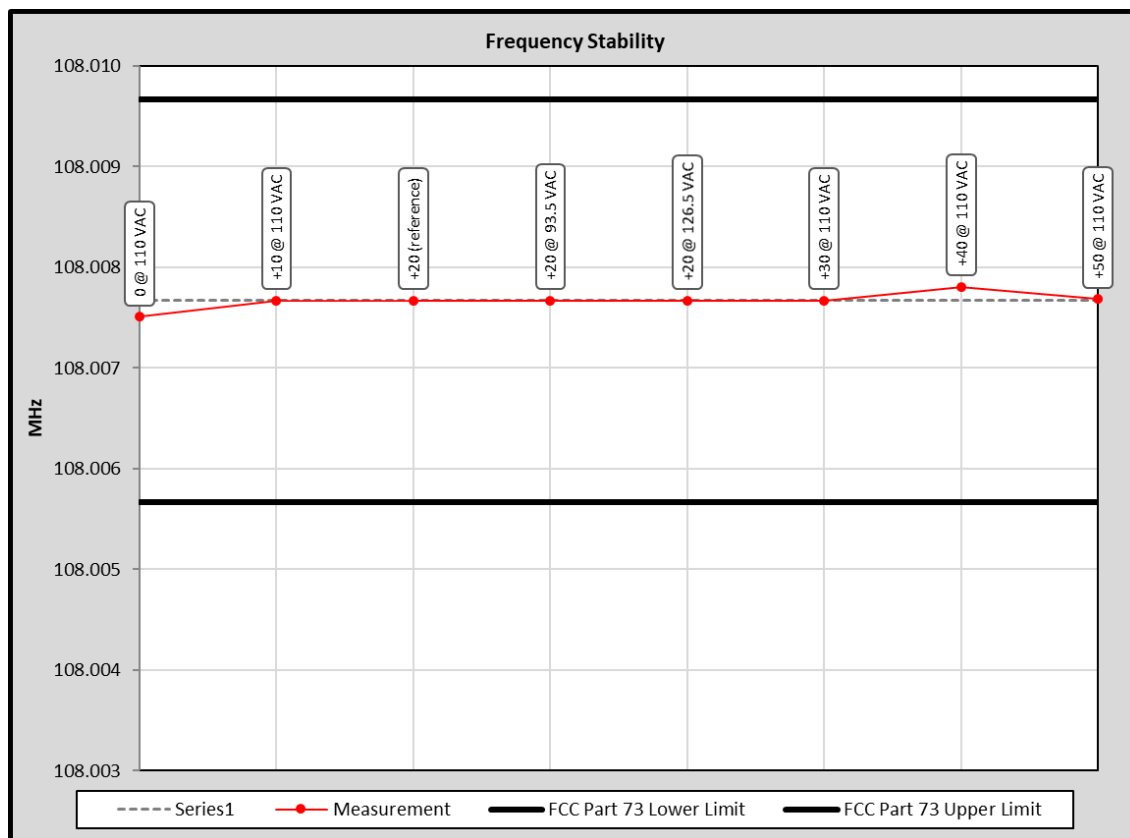

### Test Data: IC Frequency Stability Table

BETS-6 Limit	1	+/- kHz	
BETS-6 Lower Limit	108.006671	MHz	
BETS-6 Upper Limit	108.008671	MHz	
Rated Supply Voltage	110.0	<input checked="" type="radio"/> AC <input type="radio"/> DC	
Temperature / Voltage Variation			
Temperature (°C)	Supplied Voltage (V)	Frequency (MHz)	Deviation (kHz)
+20 (reference)	110	108.007671	0.000
+5	94	108.00751	0.161
+5	0	108.00751	0.161
+5	127	108.00751	0.161
+45	94	108.007682	-0.011
+45	110	108.007682	-0.011
+45	127	108.007682	-0.011

### Test Data: IC Frequency Stability Plot

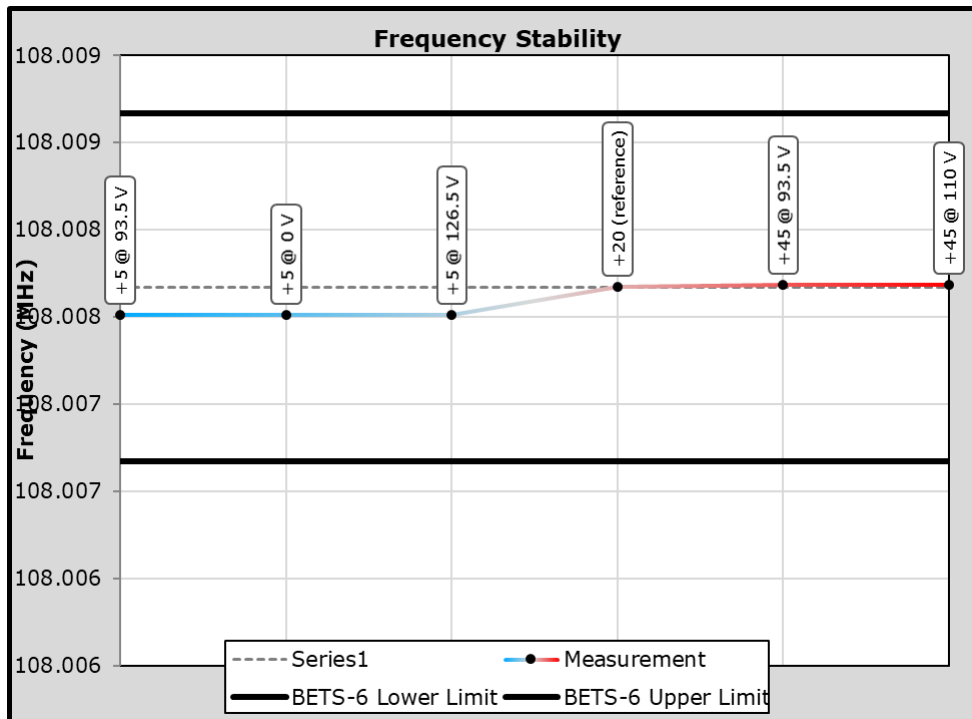

## STATE OF THE MEASUREMENT UNCERTAINTY

The data and results referenced in this document are true and accurate. The measurement uncertainty was calculated for all measurements listed in this test report according To CISPR 16-4 or ENTR 100-028 Specification for radio disturbance and immunity measuring apparatus and methods – Part 4: “Uncertainty in EMC Measurements” and is documented in the Timco Engineering, Inc. quality system according to DIN EN ISO/IEC 17025. Furthermore, component and process variability of devices similar to that tested may result in additional deviation. The manufacturer has the sole responsibility of continued compliance of the device.

Hereafter the best measurement capability for Timco Engineering, Inc. is reported:

This uncertainty represents an expanded uncertainty expressed at approximately the 95% confidence level using a coverage factor of  $k=1.96$ .

Test Items	Measurement Uncertainty	Notes
RF Frequency Accuracy	$\pm 49.5$ Hz	(1)
RF Conducted Power	$\pm 0.93$ dB	(1)
Conducted spurious emission of transmitter valid up to 40GHz	$\pm 1.86$ dB	
Occupied Bandwidth	$\pm 2.65$ %	
Audio Frequency Response	$\pm 1.86$ dB	
Modulation limiting	$\pm 1.88$ %	
Radiated RF Power	$\pm 1.4$ dB	
Maximum frequency deviation: Within 300 Hz and 6 kHz of audio freq. Within 6 kHz and 25 kHz of audio freq.	$\pm 1.88$ % $\pm 2.04$ %	
Rad Emissions Sub Meth up to 26.5GHz	$\pm 2.14$ dB	
Rad Emissions Sub Meth up to 18-40 GHz	$\pm 2.04$ %	
Adjacent channel power	$\pm 1.47$ dB	(1)
Intermodulation - Tx	$\pm 2.07$ dB	
Noise Figure	$\pm 1.00$ dB	
Transient Frequency Response	$\pm 1.88$ %	
Temperature	$\pm 1.0$ °C	(1)
Humidity	$\pm 5.0$ %	
Radiated Emissions to 6.0GHz	$\pm 4.4$ dB	
Power line conducted emissions	$\pm 3.9$ dB	

(1) This uncertainty represents an expanded uncertainty expressed at approximately the 95% confidence level using a coverage factor of  $k=1.96$ .

## EQUIPMENT LIST

Device	Manufacturer	Model	Serial Number	Cal/Char Date	Due Date
Antenna: Biconical 1096	Eaton	94455-1	1096	08/01/17	08/01/19
Antenna: Log- Periodic 1122	Electro-Metrics	LPA-25	1122	07/26/17	07/26/19
Temperature Chamber LARGE	Tenney Engineering	TTRC	11717-7	N/A	N/A
Frequency Counter	HP	5385A	2730A03025	11/08/17	11/08/19
CHAMBER	Panashield	3M	N/A	07/11/18	07/11/20
Sweep/Signal Generator	Anritsu	68369B	985112	11/08/17	11/08/19
Antenna: Double-Ridged Horn/ETS Horn 2	ETS-Lindgren	3117	00041534	03/01/17	03/01/19
Software: Field Strength Program	Timco	N/A	Version 4.10.7.0	N/A	N/A
Type K J Thermometer	Martel	303	080504494	11/06/17	11/06/19
Modulation Analyzer	HP	8901A	3050A05856	04/13/17	04/13/19
EMI Test Receiver R & S ESU 40 Chamber	Rohde & Schwarz	ESU 40	100320	08/28/18	08/28/20
Coaxial Cable - Chamber 3 cable set (Primary)	Micro-Coax	Chamber 3 cable set (Primary)	KMKM-0244-01; KMKM-0670-00; KFKF-0198-01	08/09/16	08/09/19
Function Generator	Standford	DS340	25200	02/21/18	02/21/20
Terminator N 20W DC-18G	Narda	8205	#14	04/06/17	04/06/19
Non Radiating 50 OHM Load	Tenuline	8329-300		02/01/18	02/01/21
Bore-sight Antenna Positioning Tower	Sunol Sciences	TLT2	N/A	N/A	N/A

### \*EMI RECEIVER SOFTWARE VERSION

The receiver firmware used was version 4.43 Service Pack 3

## END OF REPORT

APPLICANT: RFE BROADCAST S.R.L.  
 FCC ID: 2ARJIDS100  
 IC: 24642-DS100  
 REPORT: 2270UT18TestReport\_Rev2