

# FCC Test Report

Client Name : Shenzhen Champon Technology Co., Ltd  
Address : Room 628, Yiben Bldg.No.1063 Chaguang Road, Nanshan District, Shenzhen  
Product Name : Onvis Smart Camera C3  
Date : Apr. 24, 2020



## Shenzhen Anbotek Compliance Laboratory Limited

# Contents

1. General Information.....	4
1.1. Client Information.....	4
1.2. Description of Device (EUT).....	4
1.3. Auxiliary Equipment Used During Test.....	4
1.4. Description of Test Modes.....	5
1.5. List of channels.....	5
1.6. Description Of Test Setup.....	6
1.7. Test Equipment List.....	7
1.8. Measurement Uncertainty.....	8
1.9. Description of Test Facility.....	8
2. Summary of Test Results.....	9
3. Conducted Emission Test.....	10
3.1. Test Standard and Limit.....	10
3.2. Test Setup.....	10
3.3. Test Procedure.....	10
3.4. Test Data.....	10
4. Radiation Spurious Emission and Band Edge.....	15
4.1. Test Standard and Limit.....	15
4.2. Test Setup.....	15
4.3. Test Procedure.....	16
4.4. Test Data.....	17
5. Maximum Peak Output Power Test.....	36
5.1. Test Standard and Limit.....	36
5.2. Test Setup.....	36
5.3. Test Procedure.....	36
5.4. Test Data.....	36
6. Occupy Bandwidth Test.....	40
6.1. Test Standard.....	40
6.2. Test Setup.....	40
6.3. Test Procedure.....	40
6.4. Test Data.....	40
7. Power Spectral Density Test.....	71
7.1. Test Standard and Limit.....	71
7.2. Test Setup.....	71
7.3. Test Procedure.....	71
7.4. Test Data.....	71
8. Antenna Requirement.....	89
8.1. Test Standard and Requirement.....	89
8.2. Antenna Connected Construction.....	90
9. Frequency Stability.....	91
APPENDIX I -- PHOTOGRAPH.....	92

# TEST REPORT

Applicant : Shenzhen Champon Technology Co., Ltd  
Manufacturer : Shenzhen Champon Technology Co., Ltd  
Product Name : Onvis Smart Camera C3  
Model No. : C3  
Trade Mark : ONVIS  
Rating(s) : Input: DC 5V, 1A(via adapter Input: AC 100-240V, 50/60Hz, 0.6A; Output: DC 5V, 1A)  
Test Standard(s) : **FCC Part15 Subpart E, Paragraph 15.407**  
Test Method(s) : **ANSI C63.10: 2013,**  
**KDB 789033 D02 General UNII Test Procedures New Rules v02r01**

The device described above is tested by Shenzhen Anbotek Compliance Laboratory Limited to determine the maximum emission levels emanating from the device and the severe levels of the device can endure and its performance criterion. The measurement results are contained in this test report and Shenzhen Anbotek Compliance Laboratory Limited is assumed full of responsibility for the accuracy and completeness of these measurements. Also, this report shows that the EUT (Equipment Under Test) is technically compliant with the FCC Part 15 Subpart E requirements.

This report applies to above tested sample only and shall not be reproduced in part without written approval of Shenzhen Anbotek Compliance Laboratory Limited.

Date of Receipt : Mar. 20, 2020  
Date of Test : Mar. 20~Apr. 10, 2020

Prepared By :   
(Engineer / Dolly Mo)

Reviewer :   
(Supervisor / Bibo Zhang)

Approved & Authorized Signer :   
(Manager / Tom Chen)



# 1. General Information

## 1.1. Client Information

Applicant	:	Shenzhen Champon Technology Co., Ltd
Address	:	Room 628, Yiben Bldg.No.1063 Chaguang Road, Nanshan District, Shenzhen
Manufacturer	:	Shenzhen Champon Technology Co., Ltd
Address	:	Room 628, Yiben Bldg.No.1063 Chaguang Road, Nanshan District, Shenzhen
Factory	:	Shenzhen Champon Technology Co., Ltd
Address	:	Room 628, Yiben Bldg.No.1063 Chaguang Road, Nanshan District, Shenzhen

## 1.2. Description of Device (EUT)

Product Name	:	Onvis Smart Camera C3
Model No.	:	C3
Trade Mark	:	ONVIS
Test Power Supply	:	AC 120V, 60Hz for adapter
Test Sample No.	:	1-2-1(Normal Sample), 1-2-2(Engineering Sample)
Product Description	Operation Frequency:	5180MHz~5240MHz
	Number of Channel:	4 Channels for 802.11a 4 Channels for 802.11n(HT20) 4 Channels for 802.11ac(HT20) 2 Channels for 802.11n(HT40) 2 Channels for 802.11ac(HT40) 1 Channels for 802.11ac(HT80)
	Modulation Type:	OFDM with BPSK/QPSK/16QAM/64QAM/256QAM
	Antenna Type:	PIFA Antenna
	Antenna Gain(Peak):	2 dBi
	The directional gain:	5.01 dBi
	Remark: 1) For a more detailed features description, please refer to the manufacturer's specifications or the User's Manual. 2) This report is for WiFi 5.1G module.	

## 1.3. Auxiliary Equipment Used During Test

N/A	:	
-----	---	--

## 1.4. Description of Test Modes

To investigate the maximum EMI emission characteristics generates from EUT, the test system was pre-scanning tested base on the consideration of following EUT operation mode or test configuration mode which possible have effect on EMI emission level. Each of these EUT operation mode(s) or test configuration mode(s) mentioned above was evaluated respectively.

Mode	Test channel	Frequency (MHz)
OFDM(802.11a/n20/ac20)	CH 36	5180MHz
	CH 40	5200MHz
	CH 48	5240MHz
OFDM(802.11n40/ac40)	CH 38	5190MHz
	CH 46	5230MHz
OFDM(802.11ac80)	CH 42	5210MHz

Note:

1. The measurements are performed at the highest, middle, lowest available channels.
2. The EUT has been tested as an independent unit. And Continual Transmitting in maximum power.
3. For the relevant Conducted Measurement, the temporary antenna connector is used during the measurement. Antenna Connector Impedance: 50Ω, Cable Loss: 1.0 dB
4. The EUT was programmed to be in continuously transmitting mode and the transmit duty cycle is more than 98%

## 1.5. List of channels

### 802.11a/n20/ac20

Channel	Freq. (MHz)	Channel	Freq. (MHz)
36	5180	44	5220
40	5200	48	5240

### 802.11n40/ac40

Channel	Freq. (MHz)	Channel	Freq. (MHz)
38	5190	46	5230

### 802.11ac80

Channel	Freq. (MHz)
42	5210

### 1.6. Description Of Test Setup

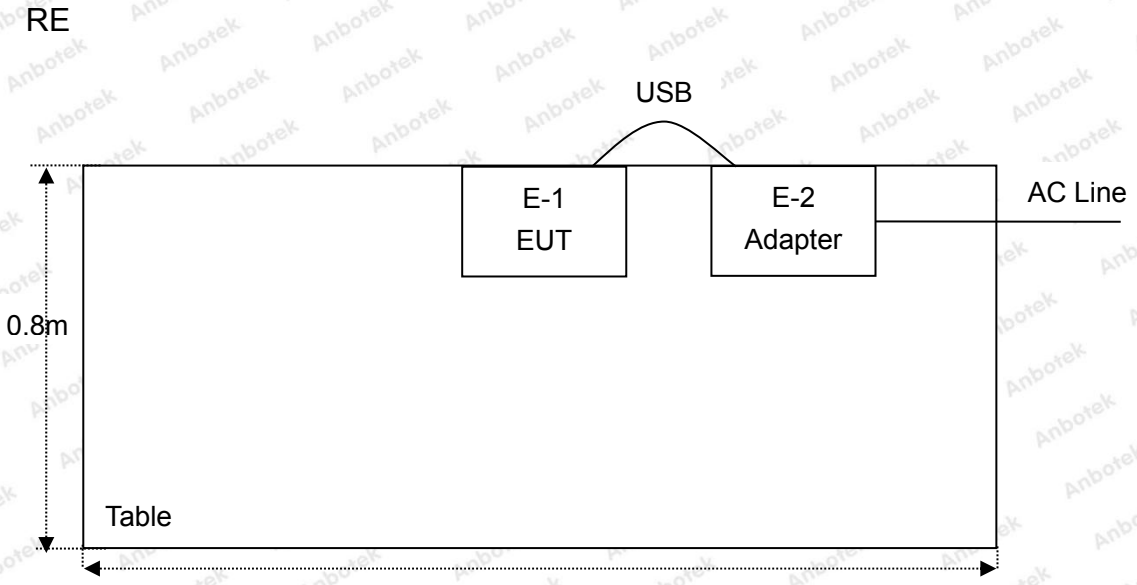
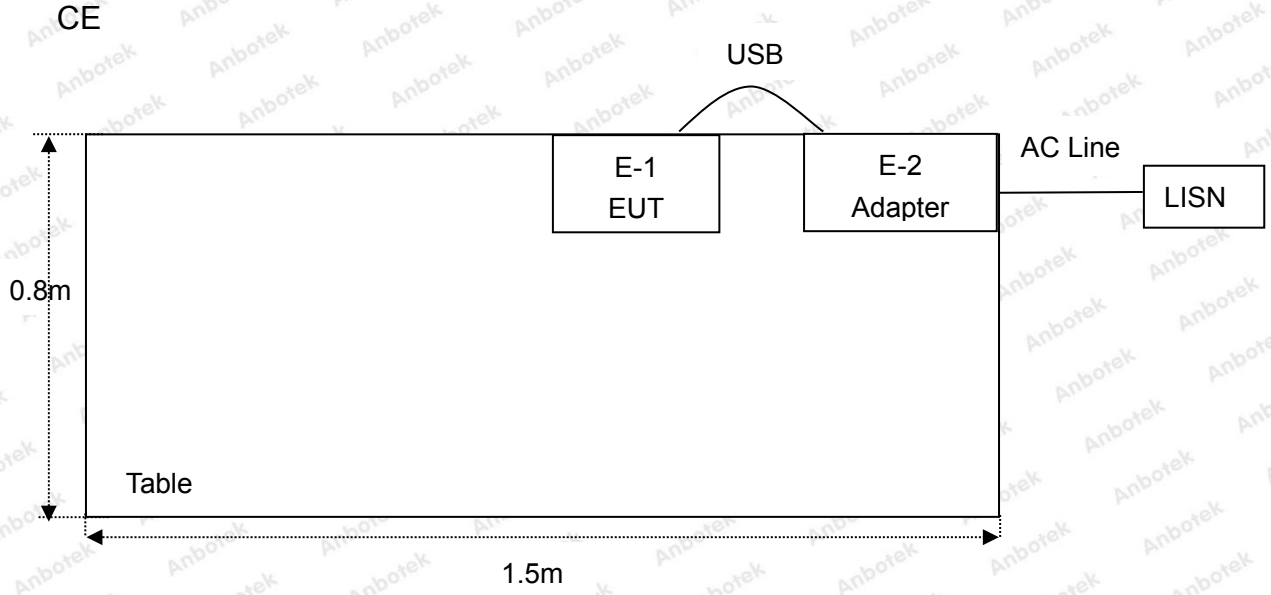



## 1.7. Test Equipment List

Item	Equipment	Manufacturer	Model No.	Serial No.	Last Cal.	Cal. Interval
1.	L.I.S.N. Artificial Mains Network	Rohde & Schwarz	ENV216	100055	Nov. 04, 2019	1 Year
2.	EMI Test Receiver	Rohde & Schwarz	ESPI3	101604	Nov. 04, 2019	1 Year
3.	RF Switching Unit	Compliance Direction	RSU-M2	38303	Nov. 04, 2019	1 Year
4.	MAX Spectrum Analysis	Agilent	N9020A	MY51170037	Nov. 04, 2019	1 Year
5.	Preamplifier	SKET Electronic	BK1G18G30 D	KD17503	Nov. 04, 2019	1 Year
6.	Double Ridged Horn Antenna	Instruments corporation	GTH-0118	351600	Nov. 01, 2019	1 Year
7.	Bilog Broadband Antenna	Schwarzbeck	VULB9163	VULB 9163-289	Nov. 01, 2019	1 Year
8.	Loop Antenna	Schwarzbeck	FMZB1519B	00053	Nov. 01, 2019	1 Year
9.	Horn Antenna	A-INFO	LB-180400-K F	J211060628	Nov. 01, 2019	1 Year
10.	Pre-amplifier	SONOMA	310N	186860	Nov. 04, 2019	1 Year
11.	EMI Test Software EZ-EMC	SHURPLE	N/A	N/A	N/A	N/A
12.	RF Test Control System	YIHENG	YH3000	2017430	Nov. 04, 2019	1 Year
13.	Power Sensor	DAER	RPR3006W	15I00041SN045	Nov. 04, 2019	1 Year
14.	Power Sensor	DAER	RPR3006W	15I00041SN046	Nov. 04, 2019	1 Year
15.	MXA Spectrum Analysis	Agilent	N9020A	MY51170037	Nov. 04, 2019	1 Year
16.	MXG RF Vector Signal Generator	Agilent	N5182A	MY48180656	Nov. 04, 2019	1 Year
17.	Signal Generator	Agilent	E4421B	MY41000743	Nov. 04, 2019	1 Year
18.	DC Power Supply	LW	TPR-6420D	374470	Nov. 04, 2019	1 Year
19.	Constant Temperature Humidity Chamber	ZHONGJIAN	ZJ-KHWS80 B	N/A	Nov. 04, 2019	1 Year

### 1.8. Measurement Uncertainty

Radiation Uncertainty	:	Ur = 3.9 dB (Horizontal)
		Ur = 3.8 dB (Vertical)
Conduction Uncertainty	:	Uc = 3.4 dB

### 1.9. Description of Test Facility

The test facility is recognized, certified, or accredited by the following organizations:

#### FCC-Registration No.: 184111

Shenzhen Anbotek Compliance Laboratory Limited, EMC Laboratory has been registered and fully described in a report filed with the (FCC) Federal Communications Commission. The acceptance letter from the FCC is maintained in our files. Registration No. 184111, September 27, 2019.

#### ISED-Registration No.: 8058A

Shenzhen Anbotek Compliance Laboratory Limited, EMC Laboratory has been registered and fully described in a report filed with the (ISED) Innovation, Science and Economic Development Canada. The acceptance letter from the ISED is maintained in our files. Registration 8058A, March 07, 2019.

#### Test Location

Shenzhen Anbotek Compliance Laboratory Limited.

1/F, Building D, Sogood Science and Technology Park, Sanwei community, Hangcheng Street, Bao'an District, Shenzhen, Guangdong, China.518102



## 2. Summary of Test Results

Standard	Test Type	Result
15.207 & 15.407	Conducted Emission	PASS
15.205/15.209	Spurious Emission	PASS
15.407(b)	Band Edge	PASS
15.407(a)(5)	Occupy Bandwidth	PASS
15.407(a)(1)(3)	Maximum Conducted Output Power	PASS
15.407(a)(1)	Peak Power Spectral Density	PASS
15.203	Antenna Requirement	PASS
15.407(g)	Frequency Stability	PASS

## 3. Conducted Emission Test

### 3.1. Test Standard and Limit

Test Standard	FCC Part15 Section 15.207&15.407		
Test Limit	Frequency	Maximum RF Line Voltage (dBuV)	
		Quasi-peak Level	Average Level
	150kHz~500kHz	66 ~ 56 *	56 ~ 46 *
	500kHz~5MHz	56	46
5MHz~30MHz	60	50	

**Remark:** (1) \*Decreasing linearly with logarithm of the frequency.  
 (2) The lower limit shall apply at the transition frequency.

### 3.2. Test Setup

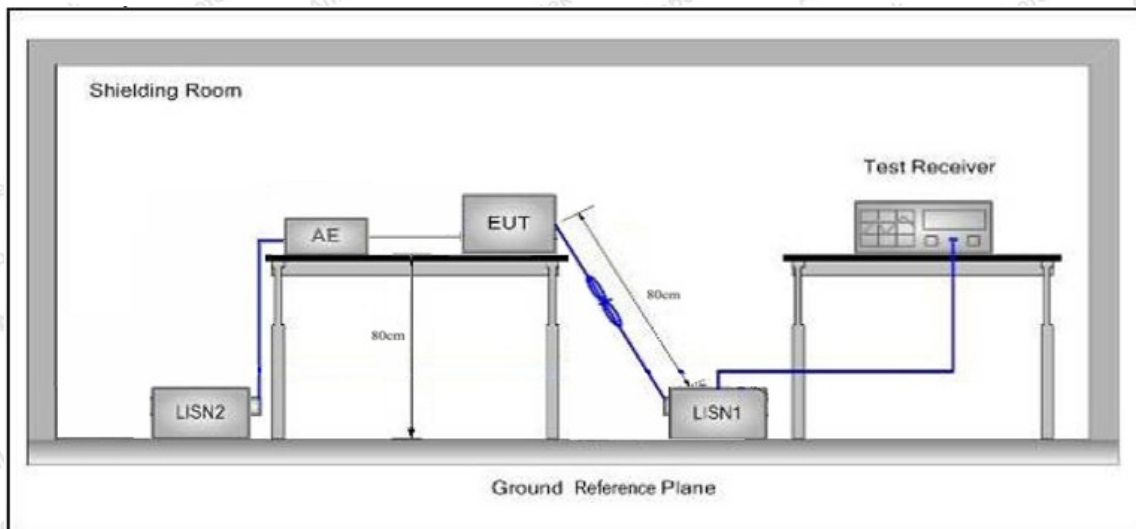

### 3.3. Test Procedure

The EUT system is connected to the power mains through a line impedance stabilization network (L.I.S.N.). This provides a 50ohm coupling impedance for the EUT system. Please refer the block diagram of the test setup and photographs. Both sides of AC line are checked to find out the maximum conducted emission. In order to find the maximum emission levels, the relative positions of equipment and all of the interface cables shall be changed according to FCC ANSI C63.10-2013 on Conducted Emission Measurement.

The bandwidth of test receiver (ESCI) set at 9kHz.

The frequency range from 150kHz to 30MHz is checked.

### 3.4. Test Data

During the test, pre-scan all modes, and found the 802.11ac20 CH36 of ANT A which is the worst case, only the worst case is recorded in the report.

**Conducted Emission Test Data**

Test Site: 1# Shielded Room  
 Operating Condition: 802.11ac20 CH36  
 Test Specification: AC 120V, 60Hz for adapter  
 Comment: Live Line  
 Tem.: 22.5°C Hum.: 52%

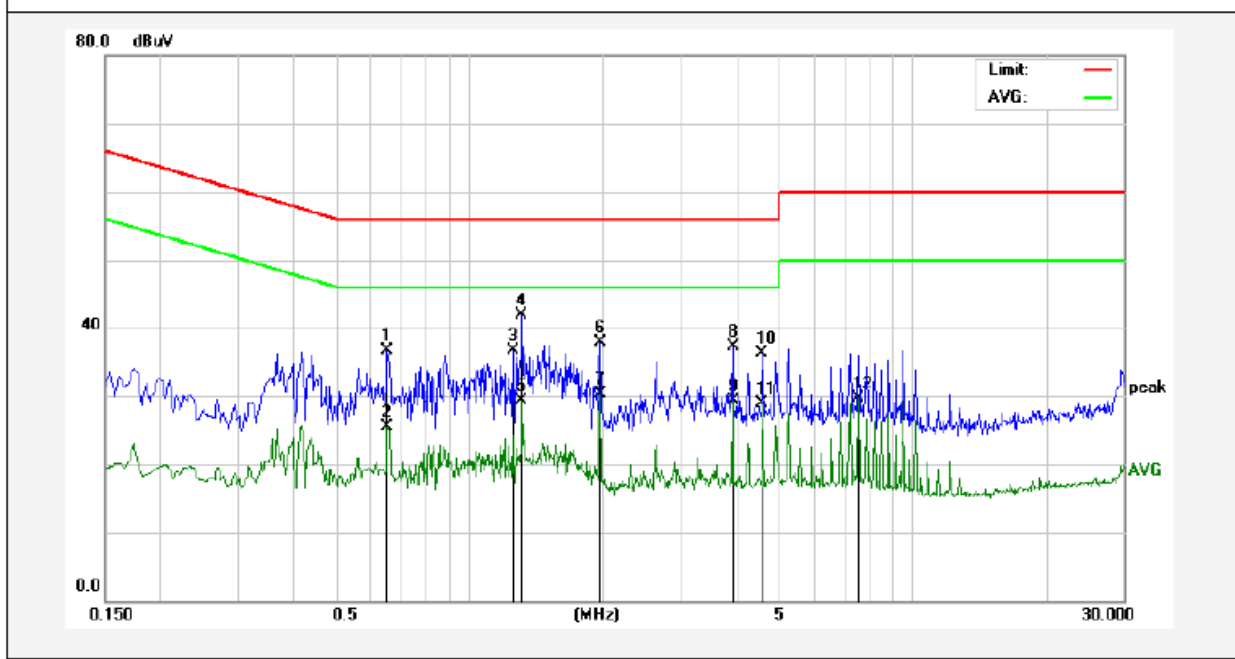

No.	Freq. (MHz)	Reading (dBuV)	Factor (dB)	Result (dBuV)	Limit (dBuV)	Over Limit (dB)	Detector	Remark
1	0.6540	16.71	20.03	36.74	56.00	-19.26	QP	
2	0.6540	5.46	20.03	25.49	46.00	-20.51	AVG	
3	1.2500	16.67	20.12	36.79	56.00	-19.21	QP	
4	1.3140	21.81	20.13	41.94	56.00	-14.06	QP	
5	1.3140	9.24	20.13	29.37	46.00	-16.63	AVG	
6	1.9700	17.72	20.14	37.86	56.00	-18.14	QP	
7	1.9700	10.09	20.14	30.23	46.00	-15.77	AVG	
8	3.9380	17.03	20.18	37.21	56.00	-18.79	QP	
9	3.9380	9.17	20.18	29.35	46.00	-16.65	AVG	
10	4.5939	16.19	20.20	36.39	56.00	-19.61	QP	
11	4.5939	8.78	20.20	28.98	46.00	-17.02	AVG	
12	7.5460	9.46	20.27	29.73	50.00	-20.27	AVG	



**Conducted Emission Test Data**

Test Site: 1# Shielded Room  
 Operating Condition: 802.11ac20 CH36  
 Test Specification: AC 120V, 60Hz for adapter  
 Comment: Neutral Line  
 Tem.: 22.5°C Hum.: 52%

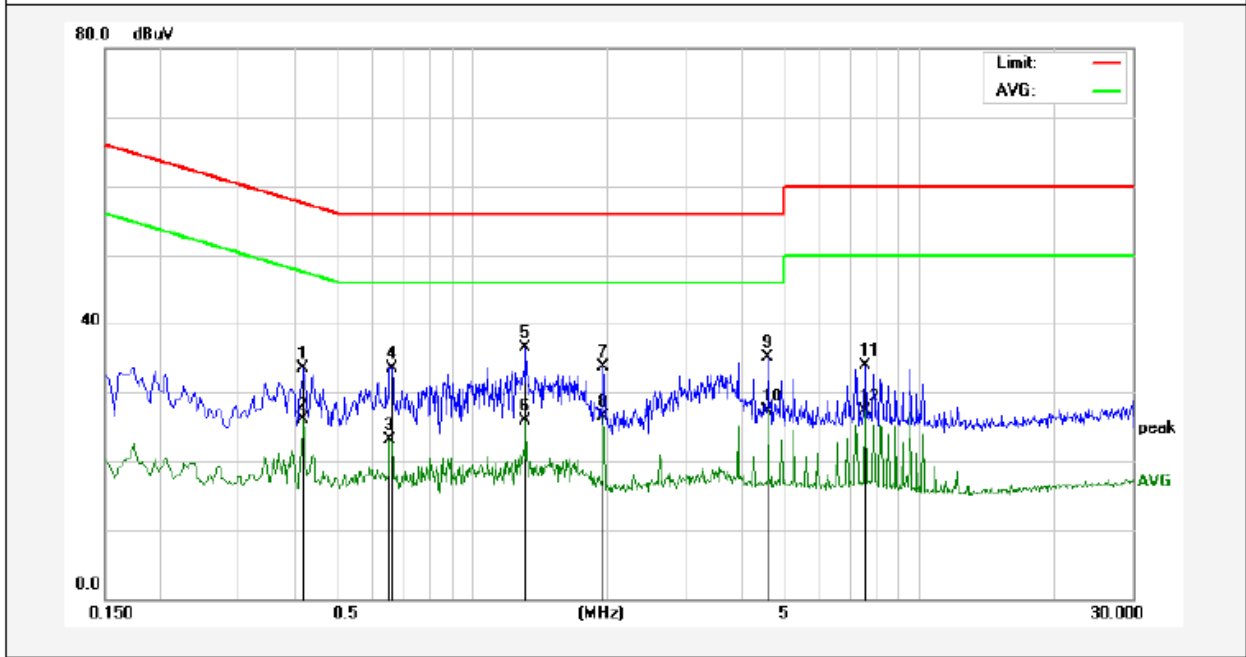

No.	Freq. (MHz)	Reading (dBuV)	Factor (dB)	Result (dBuV)	Limit (dBuV)	Over Limit (dB)	Detector	Remark
1	0.4180	13.60	19.94	33.54	57.49	-23.95	QP	
2	0.4180	6.19	19.94	26.13	47.49	-21.36	AVG	
3	0.6540	3.11	20.03	23.14	46.00	-22.86	AVG	
4	0.6580	13.55	20.03	33.58	56.00	-22.42	QP	
5	1.3099	16.34	20.13	36.47	56.00	-19.53	QP	
6	1.3099	5.75	20.13	25.88	46.00	-20.12	AVG	
7	1.9660	13.55	20.14	33.69	56.00	-22.31	QP	
8	1.9660	6.42	20.14	26.56	46.00	-19.44	AVG	
9	4.5900	14.90	20.20	35.10	56.00	-20.90	QP	
10	4.5900	7.04	20.20	27.24	46.00	-18.76	AVG	
11	7.5380	13.63	20.27	33.90	60.00	-26.10	QP	
12	7.5380	7.03	20.27	27.30	50.00	-22.70	AVG	

**Conducted Emission Test Data**

Test Site: 1# Shielded Room  
 Operating Condition: 802.11b CH01  
 Test Specification: AC 240V for adapter  
 Comment: Live Line  
 Tem.: 22.5°C Hum.: 52%

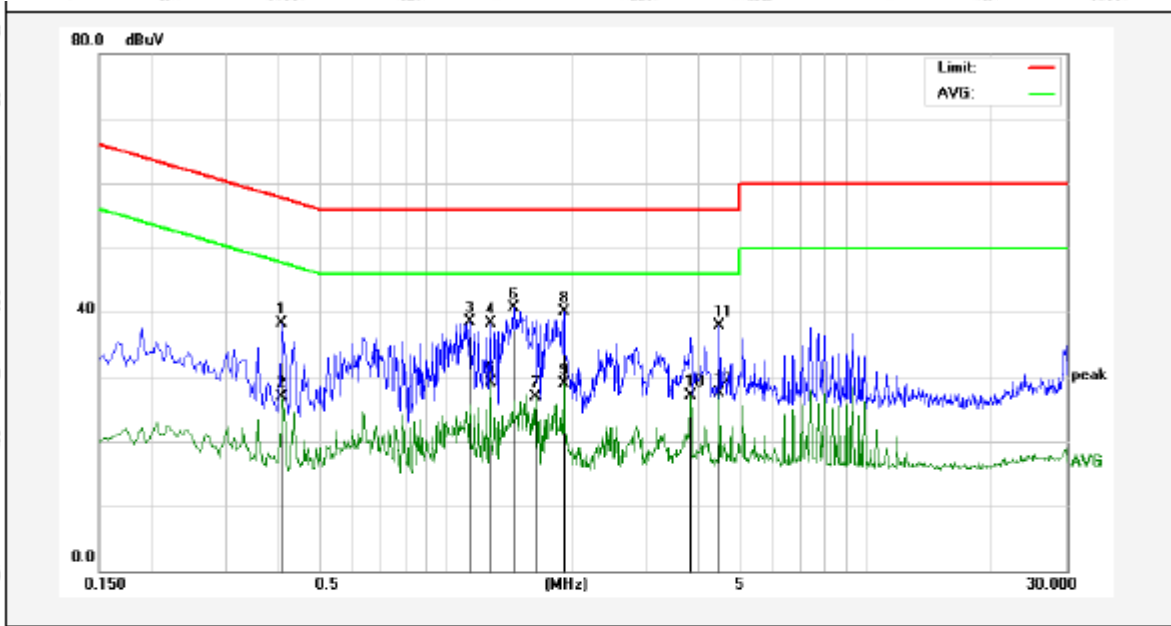

No.	Freq. (MHz)	Reading (dBuV)	Factor (dB)	Result (dBuV)	Limit (dBuV)	Over Limit (dB)	Detector	Remark
1	0.4100	18.31	19.94	38.25	57.65	-19.40	QP	
2	0.4100	6.90	19.94	26.84	47.65	-20.81	AVG	
3	1.1460	18.33	20.12	38.45	56.00	-17.55	QP	
4	1.2780	18.24	20.13	38.37	56.00	-17.63	QP	
5	1.2780	9.04	20.13	29.17	46.00	-16.83	AVG	
6	1.4500	20.60	20.13	40.73	56.00	-15.27	QP	
7	1.6420	6.71	20.13	26.84	46.00	-19.16	AVG	
8	1.9180	19.96	20.14	40.10	56.00	-15.90	QP	
9	1.9180	8.86	20.14	29.00	46.00	-17.00	AVG	
10	3.8380	6.86	20.18	27.04	46.00	-18.96	AVG	
11	4.4780	17.73	20.19	37.92	56.00	-18.08	QP	
12	4.4780	7.25	20.19	27.44	46.00	-18.56	AVG	

**Conducted Emission Test Data**

Test Site: 1# Shielded Room  
 Operating Condition: 802.11b CH01  
 Test Specification: AC 240V for adapter  
 Comment: Neutral Line  
 Tem.: 22.5°C Hum.: 52%

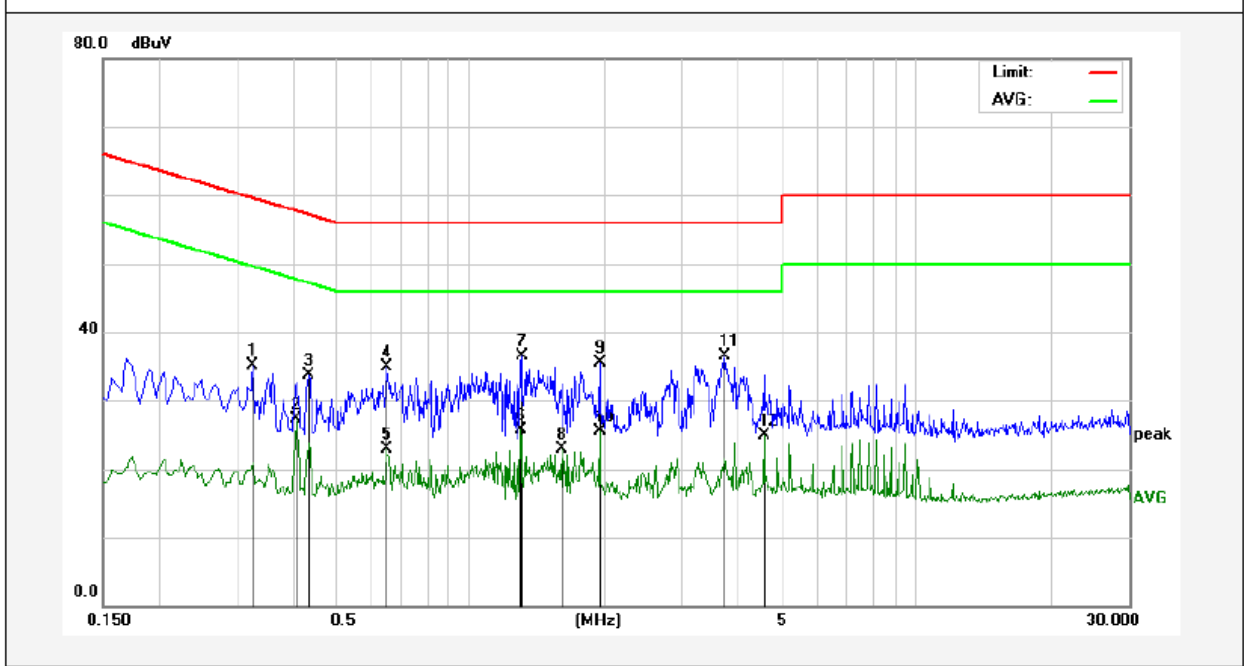

No.	Freq. (MHz)	Reading (dBuV)	Factor (dB)	Result (dBuV)	Limit (dBuV)	Over Limit (dB)	Detector	Remark
1	0.3260	15.21	19.90	35.11	59.55	-24.44	QP	
2	0.4100	7.29	19.94	27.23	47.65	-20.42	AVG	
3	0.4340	13.72	19.95	33.67	57.18	-23.51	QP	
4	0.6500	14.85	20.02	34.87	56.00	-21.13	QP	
5	0.6500	2.87	20.02	22.89	46.00	-23.11	AVG	
6	1.3020	5.58	20.13	25.71	46.00	-20.29	AVG	
7	1.3060	16.36	20.13	36.49	56.00	-19.51	QP	
8	1.6060	2.79	20.13	22.92	46.00	-23.08	AVG	
9	1.9540	15.38	20.14	35.52	56.00	-20.48	QP	
10	1.9540	5.40	20.14	25.54	46.00	-20.46	AVG	
11	3.7340	16.37	20.17	36.54	56.00	-19.46	QP	
12	4.5620	4.66	20.19	24.85	46.00	-21.15	AVG	



## 4. Radiation Spurious Emission and Band Edge

### 4.1. Test Standard and Limit

Test Standard	FCC Part15 C Section 15.209, 15.205 and 15.407				
Test Limit	Frequency (MHz)	Field strength (microvolt/meter)	Limit (dBuV/m)	Remark	Measurement distance (m)
	0.009MHz~0.490MHz	2400/F(kHz)	-	-	300
	0.490MHz-1.705MHz	24000/F(kHz)	-	-	30
	1.705MHz-30MHz	30	-	-	30
	30MHz~88MHz	100	40.0	Quasi-peak	3
	88MHz~216MHz	150	43.5	Quasi-peak	3
	216MHz~960MHz	200	46.0	Quasi-peak	3
	960MHz~1000MHz	500	54.0	Quasi-peak	3
	Above 1000MHz	500	54.0	Average	3
-		68.2	Peak	3	

**Remark:**

- (1)The lower limit shall apply at the transition frequency.
- (2) 15.35(b), Unless otherwise specified, the limit on peak radio frequency emissions is 20dB above the maximum permitted average emission limit applicable to the equipment under test. This peak limit applies to the total peak emission level radiated by the device.
- (3)Above 1GHz limit: $E[dBuV/m] = EIRP[dBm] + 95.2 = 68.2 \text{ dBuV/m}$ , for  $EIPR[dBm] = -27dBm$ .

### 4.2. Test Setup

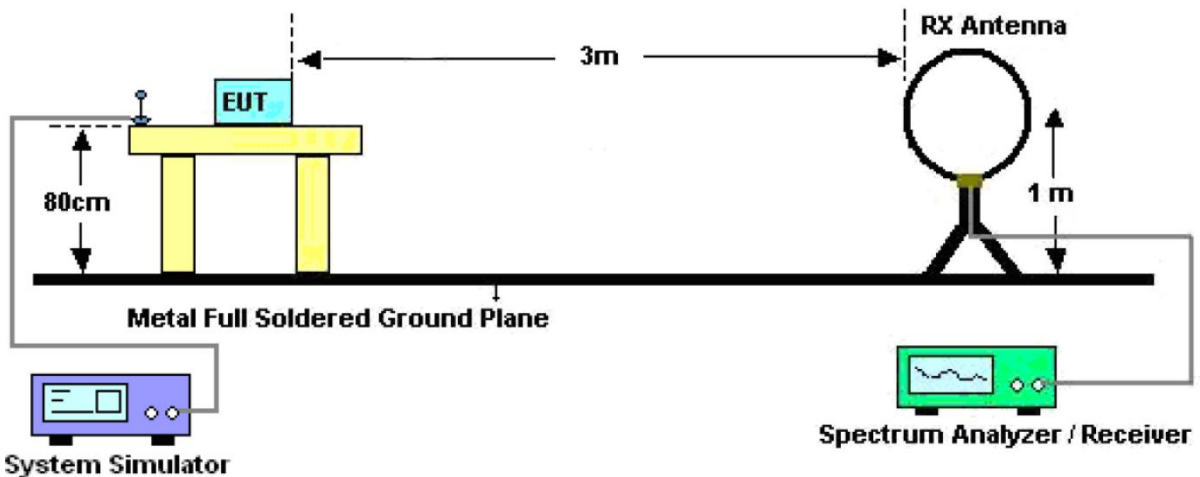

Figure 1. Below 30MHz

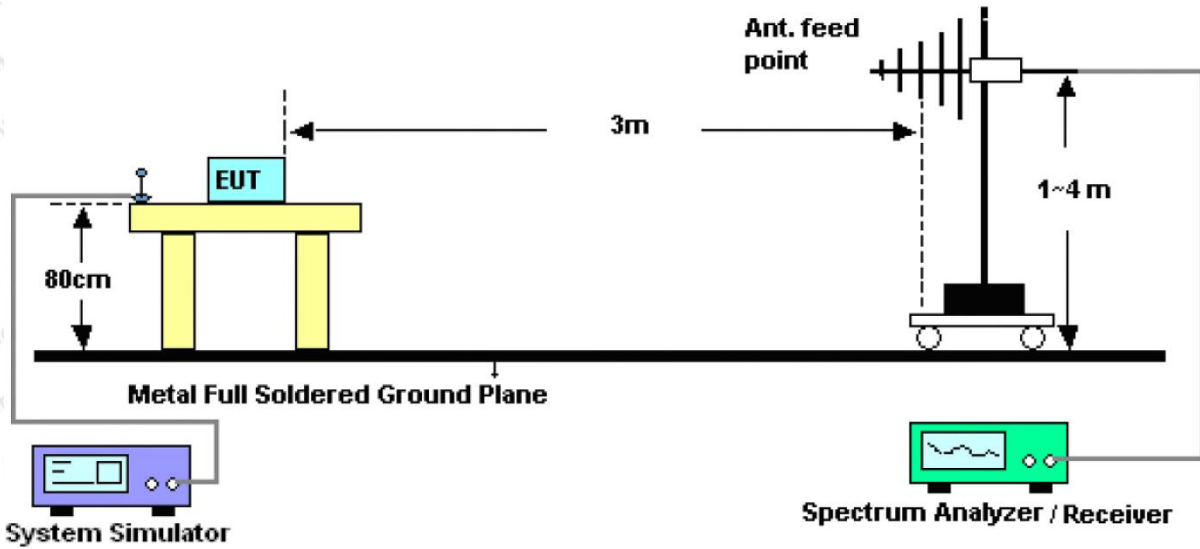

Figure 2. 30MHz to 1GHz

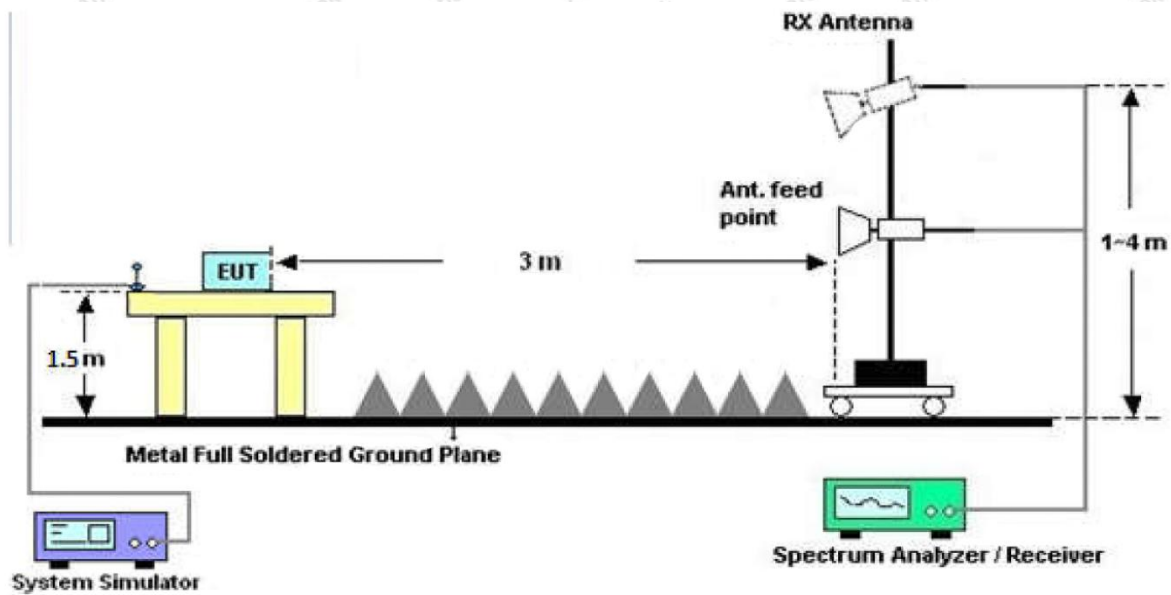

Figure 3. Above 1 GHz

### 4.3. Test Procedure

For below 1GHz: The EUT is placed on a turntable, which is 0.8m above the ground plane.

For above 1GHz: The EUT is placed on a turntable, which is 1.5m above the ground plane.

The turn table can rotate 360 degrees to determine the position of the maximum emission level. The EUT is set 3 meters away from the receiving antenna which is mounted on a antenna tower. The antenna can be moved up and down from 1 to 4 meters to find out the maximum emission level. Rotated the EUT through three orthogonal axes to determine the maximum emissions, both horizontal and vertical polarization of the antenna are set on test. The EUT is tested in 9\*6\*6 Chamber. The device is evaluated in xyz orientation.

For the radiated emission test above 1GHz:

**Shenzhen Anbotek Compliance Laboratory Limited**

Code:AB-RF-05-a

Address: 1/F., Building D, Sogood Science and Technology Park, Sanwei Community, Hangcheng Street, Bao'an District, Shenzhen, Guangdong, China.

Hotline  
400-003-0500  
www.anbotek.com

Tel:(86) 755-26066440 Fax: (86) 755-26014772 Email: service@anbotek.com

Place the measurement antenna away from each area of the EUT determined to be a source of emissions at the specified measurement distance, while keeping the measurement antenna aimed at the source of emissions at each frequency of significant emissions, with polarization oriented for maximum response. The measurement antenna may have to be higher or lower than the EUT, depending on the radiation pattern of the emission and staying aimed at the emission source for receiving the maximum signal. The final measurement antenna elevation shall be that which maximizes the emissions. The measurement antenna elevation for maximum emissions shall be restricted to a range of heights of from 1 m to 4 m above the ground or reference ground plane.

For 9kHz to 150kHz, Set the spectrum analyzer as:

RBW = 200Hz, VBW = 1kHz, Detector= Quasi-Peak, Trace mode= Max hold, Sweep- auto couple.

For 150kHz to 30MHz, Set the spectrum analyzer as:

RBW = 9kHz, VBW = 30kHz, Detector= Quasi-Peak, Trace mode= Max hold, Sweep- auto couple.

For 30MHz to 1000MHz, Set the spectrum analyzer as:

RBW = 100kHz, VBW = 300kHz, Detector= Quasi-Peak, Trace mode= Max hold, Sweep- auto couple.

For above 1GHz, Set the spectrum analyzer as:

RBW = 1MHz, VBW = 1MHz, Detector= Peak, Trace mode= Max hold, Sweep- auto couple.

RBW = 1MHz, VBW = 10Hz, Detector= Average, Trace mode= Max hold, Sweep- auto couple.

#### 4.4. Test Data

##### PASS

The test results of 9kHz-30MHz was attenuated more than 20dB below the permissible limits, so the results don't record in the report.

During the test, pre-scan all modes, and found the 802.11ac20 CH36 of ANT A which is the worst case, only the worst case is recorded in the report.





**Test Results (30~1000MHz)**

Job No.: 18220WC000226-03

Temp.(°C)/Hum.(%RH): 21.9°C/49%RH

Standard: FCC PART 15C

Power Source: AC 120V, 60Hz for adapter

Test Mode: 802.11ac20 CH36

Polarization: Horizontal

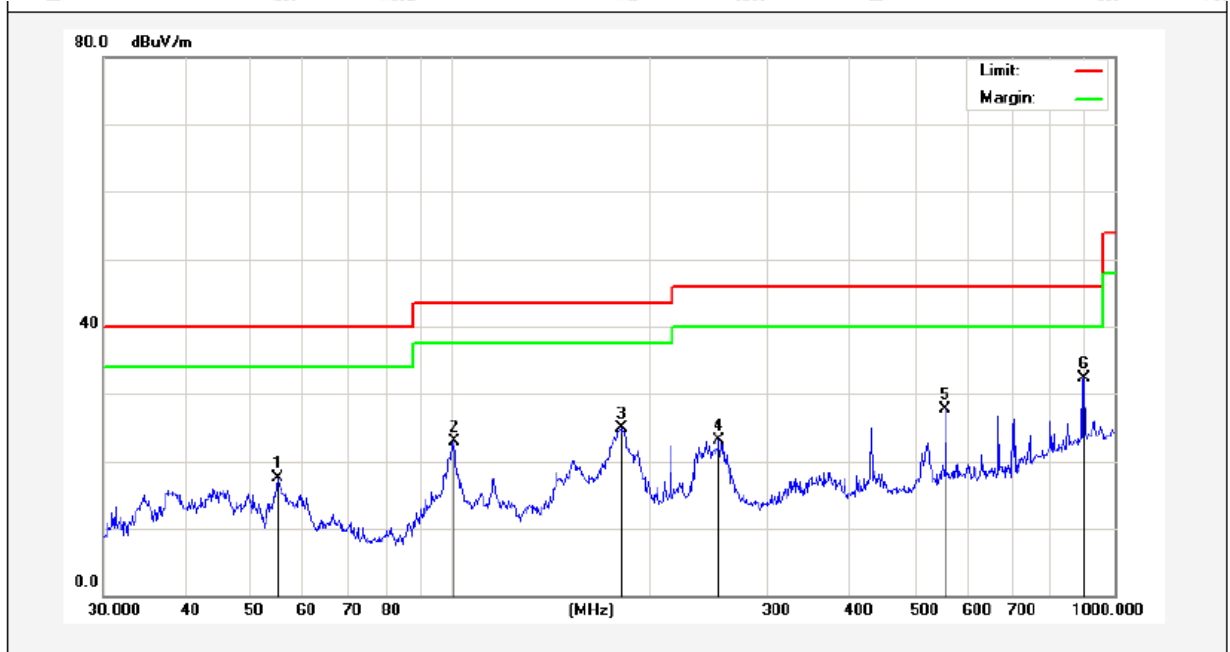

No.	Freq. (MHz)	Reading (dBuV)	Factor (dB/m)	Result (dBuV/m)	Limit (dBuV/m)	Over Limit (dB)	Detector	Height (cm)	degree (deg)	Remark
1	54.8348	35.73	-18.21	17.52	40.00	-22.48	QP	100	0	
2	101.2883	45.55	-22.64	22.91	43.50	-20.59	QP	100	360	
3	180.6484	48.05	-23.17	24.88	43.50	-18.62	QP	100	0	
4	253.8367	43.90	-20.79	23.11	46.00	-22.89	QP	100	360	
5	556.7744	40.64	-12.94	27.70	46.00	-18.30	QP	100	0	
6	900.1471	38.60	-6.39	32.21	46.00	-13.79	QP	100	360	

**Test Results (30~1000MHz)**

Job No.: 18220WC000226-03      Temp.(°C)/Hum.(%RH): 21.9°C/49%RH  
 Standard: FCC PART 15C      Power Source: AC 120V, 60Hz for adapter  
 Test Mode: 802.11ac20 CH36      Polarization: Vertical

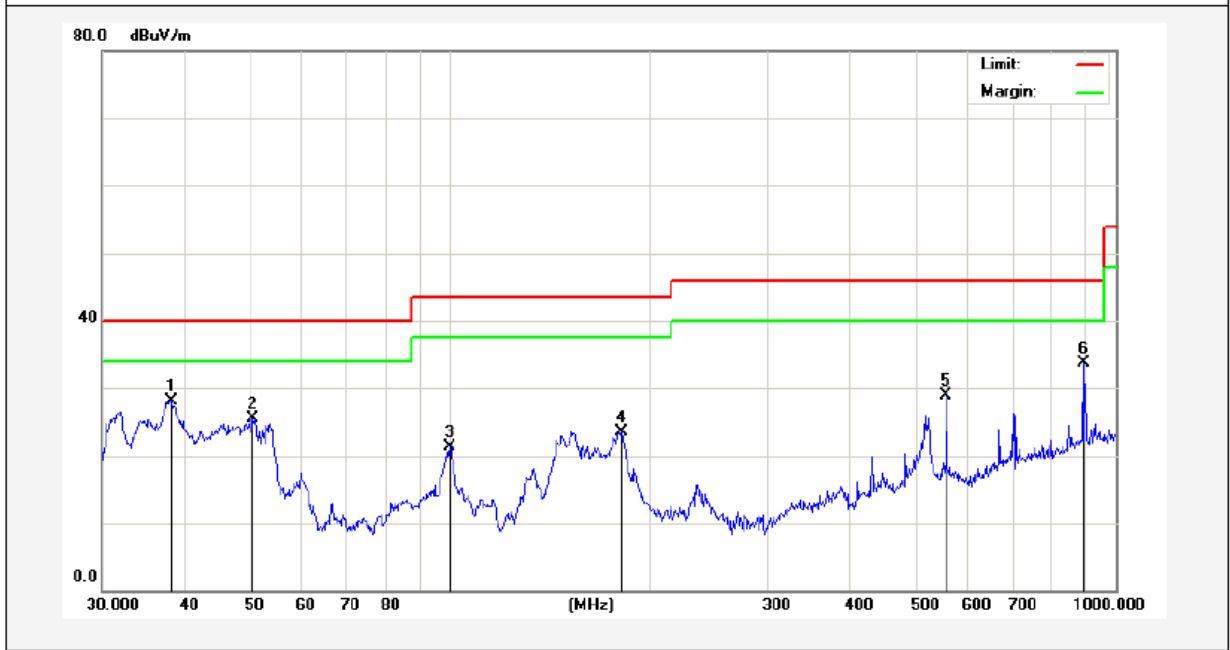

No.	Freq. (MHz)	Reading (dBuV)	Factor (dB/m)	Result (dBuV/m)	Limit (dBuV/m)	Over Limit (dB)	Detector	Height (cm)	degree (deg)	Remark
1	38.0782	45.51	-17.31	28.20	40.00	-11.80	QP	100	360	
2	50.5859	42.59	-17.12	25.47	40.00	-14.53	QP	100	0	
3	99.8777	37.80	-16.54	21.26	43.50	-22.24	QP	100	360	
4	181.2834	42.54	-19.04	23.50	43.50	-20.00	QP	100	0	
5	556.7744	40.70	-11.81	28.89	46.00	-17.11	QP	100	360	
6	893.8567	39.16	-5.52	33.64	46.00	-12.36	QP	100	0	

**Test Results (Above 1000MHz)**

Test mode:	IEEE 802.11a	Test channel:	Low CH
------------	--------------	---------------	--------

Peak value:

Frequency (MHz)	Read Level (dBuV)	Antenna Factor (dB/m)	Cable Loss (dB)	Preamp Factor (dB)	Level (dBuV/m)	Limit Line (dBuV/m)	Over Limit (dB)	Pol.
10360.00	41.26	31.98	17.08	33.91	56.41	68.20	-11.79	V
15540.00	40.88	32.65	20.03	34.85	58.71	68.20	-9.49	V
10360.00	40.24	31.98	17.08	33.91	55.39	68.20	-12.81	H
15540.00	41.46	32.65	20.03	34.85	59.29	68.20	-8.91	H

Average value:

Frequency (MHz)	Read Level (dBuV)	Antenna Factor (dB/m)	Cable Loss (dB)	Preamp Factor (dB)	Level (dBuV/m)	Limit Line (dBuV/m)	Over Limit (dB)	Pol.
10360.00	28.60	31.98	17.08	33.91	43.75	54.00	-10.25	V
15540.00	29.86	32.65	20.03	34.85	47.69	54.00	-6.31	V
10360.00	27.83	31.98	17.08	33.91	42.98	54.00	-11.02	H
15540.00	28.83	32.65	20.03	34.85	46.66	54.00	-7.34	H

Test mode:	IEEE 802.11a	Test channel:	Mid CH
------------	--------------	---------------	--------

Peak value:

Frequency (MHz)	Read Level (dBuV)	Antenna Factor (dB/m)	Cable Loss (dB)	Preamp Factor (dB)	Level (dBuV/m)	Limit Line (dBuV/m)	Over Limit (dB)	Pol.
10400.00	39.04	32.44	17.18	33.91	54.75	68.20	-13.45	V
15600.00	41.54	32.78	20.12	34.86	59.58	68.20	-8.62	V
10400.00	39.52	32.44	17.18	33.91	55.23	68.20	-12.97	H
15600.00	39.54	32.78	20.12	34.86	57.58	68.20	-10.62	H

Average value:

Frequency (MHz)	Read Level (dBuV)	Antenna Factor (dB/m)	Cable Loss (dB)	Preamp Factor (dB)	Level (dBuV/m)	Limit Line (dBuV/m)	Over Limit (dB)	Pol.
10400.00	29.64	32.44	17.18	33.91	45.35	54.00	-8.65	V
15600.00	28.43	32.78	20.12	34.86	46.47	54.00	-7.53	V
10400.00	29.61	32.44	17.18	33.91	45.32	54.00	-8.68	H
15600.00	29.24	32.78	20.12	34.86	47.28	54.00	-6.72	H



Test mode:	IEEE 802.11a	Test channel:	High CH
------------	--------------	---------------	---------

Peak value:

Frequency (MHz)	Read Level (dBuV)	Antenna Factor (dB/m)	Cable Loss (dB)	Preamp Factor (dB)	Level (dBuV/m)	Limit Line (dBuV/m)	Over Limit (dB)	Pol.
10480.00	39.05	32.59	18.02	33.92	55.74	68.20	-12.46	V
15720.00	40.25	32.87	20.15	34.88	58.39	68.20	-9.81	V
10480.00	41.17	32.59	18.02	33.92	57.86	68.20	-10.34	H
15720.00	41.72	32.87	20.15	34.88	59.86	68.20	-8.34	H

Average value:

Frequency (MHz)	Read Level (dBuV)	Antenna Factor (dB/m)	Cable Loss (dB)	Preamp Factor (dB)	Level (dBuV/m)	Limit Line (dBuV/m)	Over Limit (dB)	Pol.
10480.00	27.98	32.59	18.02	33.92	44.67	54.00	-9.33	V
15720.00	29.14	32.87	20.15	34.88	47.28	54.00	-6.72	V
10480.00	29.63	32.59	18.02	33.92	46.32	54.00	-7.68	H
15720.00	29.97	32.87	20.15	34.88	48.11	54.00	-5.89	H

Test mode:	IEEE 802.11n(HT20)	Test channel:	Low CH
------------	--------------------	---------------	--------

Peak value:

Frequency (MHz)	Read Level (dBuV)	Antenna Factor (dB/m)	Cable Loss (dB)	Preamp Factor (dB)	Level (dBuV/m)	Limit Line (dBuV/m)	Over Limit (dB)	Pol.
10360.00	41.43	31.98	17.08	33.91	56.58	68.20	-11.62	V
15540.00	40.86	32.65	20.03	34.85	58.69	68.20	-9.51	V
10360.00	41.83	31.98	17.08	33.91	56.98	68.20	-11.22	H
15540.00	41.00	32.65	20.03	34.85	58.83	68.20	-9.37	H

Average value:

Frequency (MHz)	Read Level (dBuV)	Antenna Factor (dB/m)	Cable Loss (dB)	Preamp Factor (dB)	Level (dBuV/m)	Limit Line (dBuV/m)	Over Limit (dB)	Pol.
10360.00	29.95	31.98	17.08	33.91	45.10	54.00	-8.90	V
15540.00	28.26	32.65	20.03	34.85	46.09	54.00	-7.91	V
10360.00	27.86	31.98	17.08	33.91	43.01	54.00	-10.99	H
15540.00	27.50	32.65	20.03	34.85	45.33	54.00	-8.67	H

Test mode:	IEEE 802.11n(HT20)	Test channel:	Mid CH
------------	--------------------	---------------	--------

Peak value:

Frequency (MHz)	Read Level (dBuV)	Antenna Factor (dB/m)	Cable Loss (dB)	Preamp Factor (dB)	Level (dBuV/m)	Limit Line (dBuV/m)	Over Limit (dB)	Pol.
10400.00	41.43	32.44	17.18	33.91	57.14	68.20	-11.06	V
15600.00	40.84	32.78	20.12	34.86	58.88	68.20	-9.32	V
10400.00	40.46	32.44	17.18	33.91	56.17	68.20	-12.03	H
15600.00	40.84	32.78	20.12	34.86	58.88	68.20	-9.32	H

Average value:

Frequency (MHz)	Read Level (dBuV)	Antenna Factor (dB/m)	Cable Loss (dB)	Preamp Factor (dB)	Level (dBuV/m)	Limit Line (dBuV/m)	Over Limit (dB)	Pol.
10400.00	28.13	32.44	17.18	33.91	43.84	54.00	-10.16	V
15600.00	27.60	32.78	20.12	34.86	45.64	54.00	-8.36	V
10400.00	27.04	32.44	17.18	33.91	42.75	54.00	-11.25	H
15600.00	28.26	32.78	20.12	34.86	46.30	54.00	-7.70	H

Test mode:	IEEE 802.11n(HT20)	Test channel:	High CH
------------	--------------------	---------------	---------

Peak value:

Frequency (MHz)	Read Level (dBuV)	Antenna Factor (dB/m)	Cable Loss (dB)	Preamp Factor (dB)	Level (dBuV/m)	Limit Line (dBuV/m)	Over Limit (dB)	Pol.
10480.00	40.56	32.59	18.02	33.92	57.25	68.20	-10.95	V
15720.00	40.83	32.87	20.15	34.88	58.97	68.20	-9.23	V
10480.00	41.05	32.59	18.02	33.92	57.74	68.20	-10.46	H
15720.00	39.92	32.87	20.15	34.88	58.06	68.20	-10.14	H

Average value:

Frequency (MHz)	Read Level (dBuV)	Antenna Factor (dB/m)	Cable Loss (dB)	Preamp Factor (dB)	Level (dBuV/m)	Limit Line (dBuV/m)	Over Limit (dB)	Pol.
10480.00	27.99	32.59	18.02	33.92	44.68	54.00	-9.32	V
15720.00	28.52	32.87	20.15	34.88	46.66	54.00	-7.34	V
10480.00	29.02	32.59	18.02	33.92	45.71	54.00	-8.29	H
15720.00	27.96	32.87	20.15	34.88	46.10	54.00	-7.90	H

Test mode:	IEEE 802.11ac(HT20)	Test channel:	Low CH
------------	---------------------	---------------	--------

Peak value:

Frequency (MHz)	Read Level (dBuV)	Antenna Factor (dB/m)	Cable Loss (dB)	Preamp Factor (dB)	Level (dBuV/m)	Limit Line (dBuV/m)	Over Limit (dB)	Pol.
10360.00	40.94	31.98	17.08	33.91	56.09	68.20	-12.11	V
15540.00	41.17	32.65	20.03	34.85	59.00	68.20	-9.20	V
10360.00	39.22	31.98	17.08	33.91	54.37	68.20	-13.83	H
15540.00	39.63	32.65	20.03	34.85	57.46	68.20	-10.74	H

Average value:

Frequency (MHz)	Read Level (dBuV)	Antenna Factor (dB/m)	Cable Loss (dB)	Preamp Factor (dB)	Level (dBuV/m)	Limit Line (dBuV/m)	Over Limit (dB)	Pol.
10360.00	28.18	31.98	17.08	33.91	43.33	54.00	-10.67	V
15540.00	29.31	32.65	20.03	34.85	47.14	54.00	-6.86	V
10360.00	28.08	31.98	17.08	33.91	43.23	54.00	-10.77	H
15540.00	29.44	32.65	20.03	34.85	47.27	54.00	-6.73	H

Test mode:	IEEE 802.11ac(HT20)	Test channel:	Mid CH
------------	---------------------	---------------	--------

Peak value:

Frequency (MHz)	Read Level (dBuV)	Antenna Factor (dB/m)	Cable Loss (dB)	Preamp Factor (dB)	Level (dBuV/m)	Limit Line (dBuV/m)	Over Limit (dB)	Pol.
10400.00	41.04	32.44	17.18	33.91	56.75	68.20	-11.45	V
15600.00	40.73	32.78	20.12	34.86	58.77	68.20	-9.43	V
10400.00	39.81	32.44	17.18	33.91	55.52	68.20	-12.68	H
15600.00	40.11	32.78	20.12	34.86	58.15	68.20	-10.05	H

Average value:

Frequency (MHz)	Read Level (dBuV)	Antenna Factor (dB/m)	Cable Loss (dB)	Preamp Factor (dB)	Level (dBuV/m)	Limit Line (dBuV/m)	Over Limit (dB)	Pol.
10400.00	29.87	32.44	17.18	33.91	45.58	54.00	-8.42	V
15600.00	29.88	32.78	20.12	34.86	47.92	54.00	-6.08	V
10400.00	27.82	32.44	17.18	33.91	43.53	54.00	-10.47	H
15600.00	27.27	32.78	20.12	34.86	45.31	54.00	-8.69	H



Test mode:	IEEE 802.11ac(HT20)	Test channel:	High CH
------------	---------------------	---------------	---------

Peak value:

Frequency (MHz)	Read Level (dBuV)	Antenna Factor (dB/m)	Cable Loss (dB)	Preamp Factor (dB)	Level (dBuV/m)	Limit Line (dBuV/m)	Over Limit (dB)	Pol.
10480.00	40.80	32.59	18.02	33.92	57.49	68.20	-10.71	V
15720.00	41.87	32.87	20.15	34.88	60.01	68.20	-8.19	V
10480.00	40.20	32.59	18.02	33.92	56.89	68.20	-11.31	H
15720.00	39.40	32.87	20.15	34.88	57.54	68.20	-10.66	H

Average value:

Frequency (MHz)	Read Level (dBuV)	Antenna Factor (dB/m)	Cable Loss (dB)	Preamp Factor (dB)	Level (dBuV/m)	Limit Line (dBuV/m)	Over Limit (dB)	Pol.
10480.00	28.81	32.59	18.02	33.92	45.50	54.00	-8.50	V
15720.00	29.63	32.87	20.15	34.88	47.77	54.00	-6.23	V
10480.00	29.07	32.59	18.02	33.92	45.76	54.00	-8.24	H
15720.00	28.89	32.87	20.15	34.88	47.03	54.00	-6.97	H

Test mode:	IEEE 802.11n(HT40)	Test channel:	Low CH
------------	--------------------	---------------	--------

Peak value:

Frequency (MHz)	Read Level (dBuV)	Antenna Factor (dB/m)	Cable Loss (dB)	Preamp Factor (dB)	Level (dBuV/m)	Limit Line (dBuV/m)	Over Limit (dB)	Pol.
10380.00	41.21	31.98	17.08	33.91	56.36	68.20	-11.84	V
15570.00	40.20	32.65	20.03	34.85	58.03	68.20	-10.17	V
10380.00	41.04	31.98	17.08	33.91	56.19	68.20	-12.01	H
15570.00	41.44	32.65	20.03	34.85	59.27	68.20	-8.93	H

Average value:

Frequency (MHz)	Read Level (dBuV)	Antenna Factor (dB/m)	Cable Loss (dB)	Preamp Factor (dB)	Level (dBuV/m)	Limit Line (dBuV/m)	Over Limit (dB)	Pol.
10380.00	29.90	31.98	17.08	33.91	45.05	54.00	-8.95	V
15570.00	28.35	32.65	20.03	34.85	46.18	54.00	-7.82	V
10380.00	28.01	31.98	17.08	33.91	43.16	54.00	-10.84	H
15570.00	29.49	32.65	20.03	34.85	47.32	54.00	-6.68	H

Test mode:	IEEE 802.11n(HT40)	Test channel:	High CH
------------	--------------------	---------------	---------

Peak value:

Frequency (MHz)	Read Level (dBuV)	Antenna Factor (dB/m)	Cable Loss (dB)	Preamp Factor (dB)	Level (dBuV/m)	Limit Line (dBuV/m)	Over Limit (dB)	Pol.
10460.00	39.54	32.59	18.02	33.92	56.23	68.20	-11.97	V
15690.00	41.48	32.87	20.15	34.88	59.62	68.20	-8.58	V
10460.00	40.56	32.59	18.02	33.92	57.25	68.20	-10.95	H
15690.00	39.93	32.87	20.15	34.88	58.07	68.20	-10.13	H

Average value:

Frequency (MHz)	Read Level (dBuV)	Antenna Factor (dB/m)	Cable Loss (dB)	Preamp Factor (dB)	Level (dBuV/m)	Limit Line (dBuV/m)	Over Limit (dB)	Pol.
10460.00	28.57	32.59	18.02	33.92	45.26	54.00	-8.74	V
15690.00	28.04	32.87	20.15	34.88	46.18	54.00	-7.82	V
10460.00	27.77	32.59	18.02	33.92	44.46	54.00	-9.54	H
15690.00	29.82	32.78	20.12	34.86	47.86	54.00	-6.14	H

Test mode:	IEEE 802.11ac(HT40)	Test channel:	Low CH
------------	---------------------	---------------	--------

Peak value:

Frequency (MHz)	Read Level (dBuV)	Antenna Factor (dB/m)	Cable Loss (dB)	Preamp Factor (dB)	Level (dBuV/m)	Limit Line (dBuV/m)	Over Limit (dB)	Pol.
10380.00	41.36	31.98	17.08	33.91	56.51	68.20	-11.69	V
15570.00	39.83	32.65	20.03	34.85	57.66	68.20	-10.54	V
10380.00	39.83	31.98	17.08	33.91	54.98	68.20	-13.22	H
15570.00	41.79	32.65	20.03	34.85	59.62	68.20	-8.58	H

Average value:

Frequency (MHz)	Read Level (dBuV)	Antenna Factor (dB/m)	Cable Loss (dB)	Preamp Factor (dB)	Level (dBuV/m)	Limit Line (dBuV/m)	Over Limit (dB)	Pol.
10380.00	27.45	31.98	17.08	33.91	42.60	54.00	-11.40	V
15570.00	29.70	32.65	20.03	34.85	47.53	54.00	-6.47	V
10380.00	27.80	31.98	17.08	33.91	42.95	54.00	-11.05	H
15570.00	29.79	32.65	20.03	34.85	47.62	54.00	-6.38	H

Test mode:	IEEE 802.11ac(HT40)	Test channel:	High CH
------------	---------------------	---------------	---------

Peak value:

Frequency (MHz)	Read Level (dBuV)	Antenna Factor (dB/m)	Cable Loss (dB)	Preamp Factor (dB)	Level (dBuV/m)	Limit Line (dBuV/m)	Over Limit (dB)	Pol.
10460.00	39.95	32.59	18.02	33.92	56.64	68.20	-11.56	V
15690.00	40.98	32.87	20.15	34.88	59.12	68.20	-9.08	V
10460.00	41.05	32.59	18.02	33.92	57.74	68.20	-10.46	H
15690.00	39.46	32.87	20.15	34.88	57.60	68.20	-10.60	H

Average value:

Frequency (MHz)	Read Level (dBuV)	Antenna Factor (dB/m)	Cable Loss (dB)	Preamp Factor (dB)	Level (dBuV/m)	Limit Line (dBuV/m)	Over Limit (dB)	Pol.
10460.00	28.06	32.59	18.02	33.92	44.75	54.00	-9.25	V
15690.00	28.36	32.87	20.15	34.88	46.50	54.00	-7.50	V
10460.00	28.85	32.59	18.02	33.92	45.54	54.00	-8.46	H
15690.00	28.74	32.78	20.12	34.86	46.78	54.00	-7.22	H

Test mode:	IEEE 802.11ac(HT80)	Test channel:	
------------	---------------------	---------------	--

Peak value:

Frequency (MHz)	Read Level (dBuV)	Antenna Factor (dB/m)	Cable Loss (dB)	Preamp Factor (dB)	Level (dBuV/m)	Limit Line (dBuV/m)	Over Limit (dB)	Pol.
10420.00	41.05	32.44	17.18	33.91	56.76	68.20	-11.44	V
15630.00	41.01	32.78	20.12	34.86	59.05	68.20	-9.15	V
10420.00	40.09	32.44	17.18	33.91	55.80	68.20	-12.40	H
15630.00	39.11	32.78	20.12	34.86	57.15	68.20	-11.05	H

Average value:

Frequency (MHz)	Read Level (dBuV)	Antenna Factor (dB/m)	Cable Loss (dB)	Preamp Factor (dB)	Level (dBuV/m)	Limit Line (dBuV/m)	Over Limit (dB)	Pol.
10420.00	27.59	32.44	17.18	33.91	43.30	54.00	-10.70	V
15630.00	28.48	32.78	20.12	34.86	46.52	54.00	-7.48	V
10420.00	29.16	32.44	17.18	33.91	44.87	54.00	-9.13	H
15630.00	27.39	32.78	20.12	34.86	45.43	54.00	-8.57	H

Note:

1. Final Level =Receiver Read level + Antenna Factor + Cable Loss–Preamplifier Factor
2. the data provided now is the worst data
3. The test data is ANT A+ANT B, which is tested in the MIMO case.



**Radiated Band Edge:**

Test Mode: 802.11a								
Peak Value								
Frequency (MHz)	Read Level (dBuV)	Antenna Factor (dB/m)	Cable Loss (dB)	Preamp Factor (dB)	Level (dBuV/m)	Limit (dBuV/m)	Over Limit (dB)	Pol.
5150.00	46.33	28.65	13.58	31.04	57.52	68.20	-10.68	H
5350.00	48.36	29.16	14.68	31.96	60.24	68.20	-7.96	H
5150.00	46.27	28.65	13.58	31.04	57.46	68.20	-10.74	V
5350.00	46.02	29.16	14.68	31.96	57.90	68.20	-10.30	V
Average Value								
Frequency (MHz)	Read Level (dBuV)	Antenna Factor (dB/m)	Cable Loss (dB)	Preamp Factor (dB)	Level (dBuV/m)	Limit (dBuV/m)	Over Limit (dB)	Pol.
5150.00	32.28	28.65	13.58	31.04	43.47	54.00	-10.53	H
5350.00	33.03	29.16	14.68	31.96	44.91	54.00	-9.09	H
5150.00	32.41	28.65	13.58	31.04	43.60	54.00	-10.40	V
5350.00	33.66	29.16	14.68	31.96	45.54	54.00	-8.46	V

Test Mode: 802.11n20								
Peak Value								
Frequency (MHz)	Read Level (dBuV)	Antenna Factor (dB/m)	Cable Loss (dB)	Preamp Factor (dB)	Level (dBuV/m)	Limit (dBuV/m)	Over Limit (dB)	Pol.
5150.00	46.53	28.65	13.58	31.04	57.72	68.20	-10.48	H
5350.00	48.61	29.16	14.68	31.96	60.49	68.20	-7.71	H
5150.00	48.90	28.65	13.58	31.04	60.09	68.20	-8.11	V
5350.00	45.95	29.16	14.68	31.96	57.83	68.20	-10.37	V
Average Value								
Frequency (MHz)	Read Level (dBuV)	Antenna Factor (dB/m)	Cable Loss (dB)	Preamp Factor (dB)	Level (dBuV/m)	Limit (dBuV/m)	Over Limit (dB)	Pol.
5150.00	34.67	28.65	13.58	31.04	45.86	54.00	-8.14	H
5350.00	32.97	29.16	14.68	31.96	44.85	54.00	-9.15	H
5150.00	33.95	28.65	13.58	31.04	45.14	54.00	-8.86	V
5350.00	32.70	29.16	14.68	31.96	44.58	54.00	-9.42	V

Test Mode: 802.11ac20								
Peak Value								
Frequency (MHz)	Read Level (dBuV)	Antenna Factor (dB/m)	Cable Loss (dB)	Preamp Factor (dB)	Level (dBuV/m)	Limit (dBuV/m)	Over Limit (dB)	Pol.
5150.00	48.90	28.65	13.58	31.04	60.09	68.20	-8.11	H
5350.00	48.11	29.16	14.68	31.96	59.99	68.20	-8.21	H
5150.00	48.64	28.65	13.58	31.04	59.83	68.20	-8.37	V
5350.00	47.88	29.16	14.68	31.96	59.76	68.20	-8.44	V
Average Value								
Frequency (MHz)	Read Level (dBuV)	Antenna Factor (dB/m)	Cable Loss (dB)	Preamp Factor (dB)	Level (dBuV/m)	Limit (dBuV/m)	Over Limit (dB)	Pol.
5150.00	33.70	28.65	13.58	31.04	44.89	54.00	-9.11	H
5350.00	32.58	29.16	14.68	31.96	44.46	54.00	-9.54	H
5150.00	34.73	28.65	13.58	31.04	45.92	54.00	-8.08	V
5350.00	32.08	29.16	14.68	31.96	43.96	54.00	-10.04	V

Test Mode: 802.11n40								
Peak Value								
Frequency (MHz)	Read Level (dBuV)	Antenna Factor (dB/m)	Cable Loss (dB)	Preamp Factor (dB)	Level (dBuV/m)	Limit (dBuV/m)	Over Limit (dB)	Pol.
5150.00	46.06	28.65	13.58	31.04	57.25	68.20	-10.95	H
5350.00	48.45	29.16	14.68	31.96	60.33	68.20	-7.87	H
5150.00	48.59	28.65	13.58	31.04	59.78	68.20	-8.42	V
5350.00	48.75	29.16	14.68	31.96	60.63	68.20	-7.57	V
Average Value								
Frequency (MHz)	Read Level (dBuV)	Antenna Factor (dB/m)	Cable Loss (dB)	Preamp Factor (dB)	Level (dBuV/m)	Limit (dBuV/m)	Over Limit (dB)	Pol.
5150.00	32.03	28.65	13.58	31.04	43.22	54.00	-10.78	H
5350.00	33.28	29.16	14.68	31.96	45.16	54.00	-8.84	H
5150.00	34.21	28.65	13.58	31.04	45.40	54.00	-8.60	V
5350.00	34.27	29.16	14.68	31.96	46.15	54.00	-7.85	V

Test Mode: 802.11ac40								
Peak Value								
Frequency (MHz)	Read Level (dBuV)	Antenna Factor (dB/m)	Cable Loss (dB)	Preamp Factor (dB)	Level (dBuV/m)	Limit (dBuV/m)	Over Limit (dB)	Pol.
5150.00	45.83	28.65	13.58	31.04	57.02	68.20	-11.18	H
5350.00	45.55	29.16	14.68	31.96	57.43	68.20	-10.77	H
5150.00	47.10	28.65	13.58	31.04	58.29	68.20	-9.91	V
5350.00	45.79	29.16	14.68	31.96	57.67	68.20	-10.53	V
Average Value								
Frequency (MHz)	Read Level (dBuV)	Antenna Factor (dB/m)	Cable Loss (dB)	Preamp Factor (dB)	Level (dBuV/m)	Limit (dBuV/m)	Over Limit (dB)	Pol.
5150.00	33.20	28.65	13.58	31.04	44.39	54.00	-9.61	H
5350.00	34.89	29.16	14.68	31.96	46.77	54.00	-7.23	H
5150.00	34.65	28.65	13.58	31.04	45.84	54.00	-8.16	V
5350.00	34.17	29.16	14.68	31.96	46.05	54.00	-7.95	V

Test Mode: 802.11ac80								
Peak Value								
Frequency (MHz)	Read Level (dBuV)	Antenna Factor (dB/m)	Cable Loss (dB)	Preamp Factor (dB)	Level (dBuV/m)	Limit (dBuV/m)	Over Limit (dB)	Pol.
5150.00	45.01	28.65	13.58	31.04	56.20	68.20	-12.00	H
5350.00	48.36	29.16	14.68	31.96	60.24	68.20	-7.96	H
5150.00	48.11	28.65	13.58	31.04	59.30	68.20	-8.90	V
5350.00	45.18	29.16	14.68	31.96	57.06	68.20	-11.14	V
Average Value								
Frequency (MHz)	Read Level (dBuV)	Antenna Factor (dB/m)	Cable Loss (dB)	Preamp Factor (dB)	Level (dBuV/m)	Limit (dBuV/m)	Over Limit (dB)	Pol.
5150.00	34.66	28.65	13.58	31.04	45.85	54.00	-8.15	H
5350.00	33.97	29.16	14.68	31.96	45.85	54.00	-8.15	H
5150.00	33.34	28.65	13.58	31.04	44.53	54.00	-9.47	V
5350.00	32.65	29.16	14.68	31.96	44.53	54.00	-9.47	V

Remark: 1.the data provided now is the worst data

2. The test data is ANT A+ANT B, which is tested in the MIMO case.



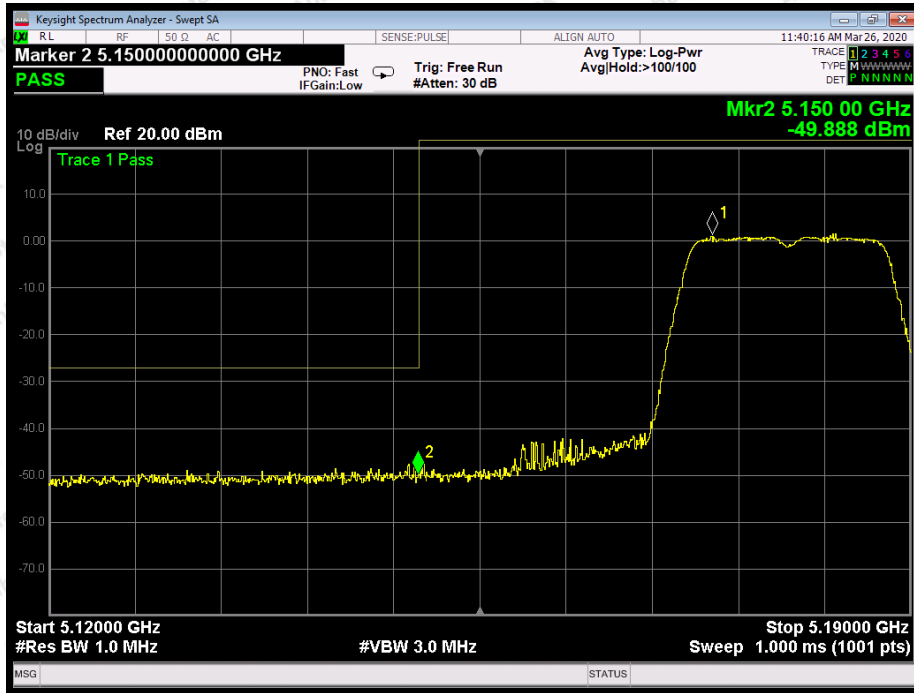

802.11a: Band Edge, Left Side

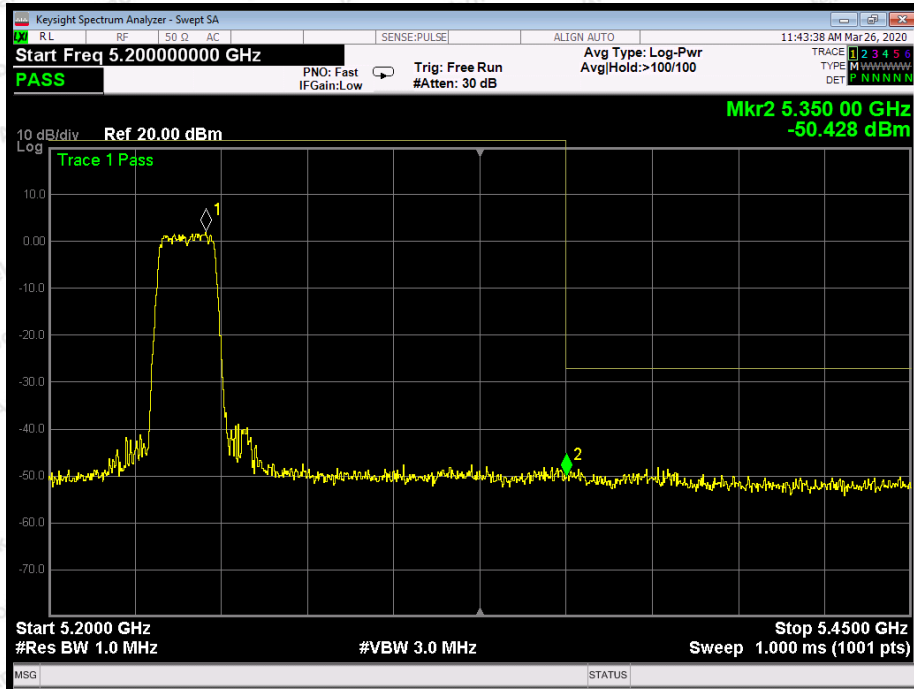

802.11a: Band Edge, Right Side

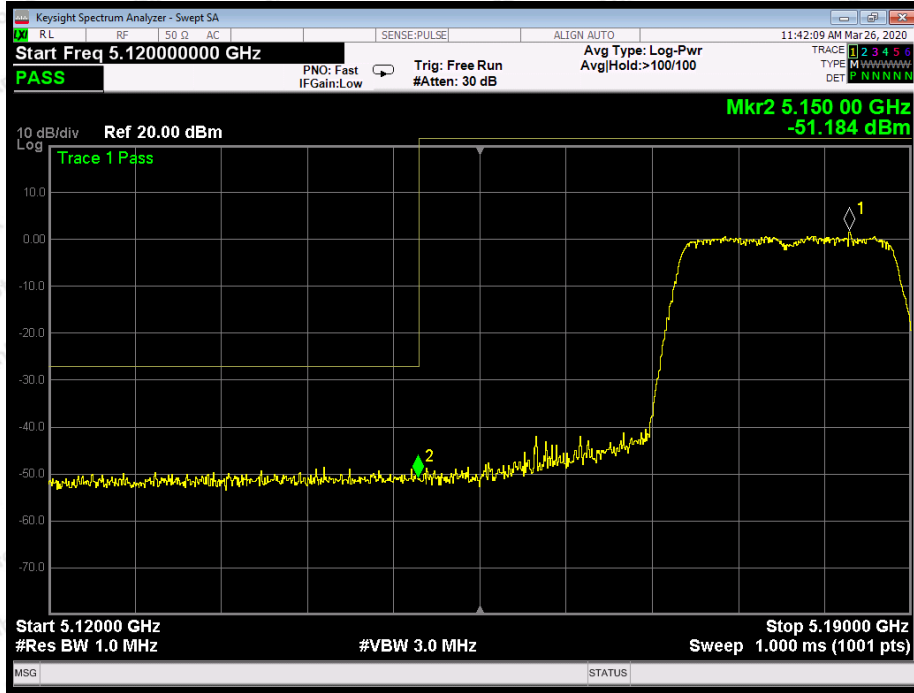

802.11n(20): Band Edge, Left Side

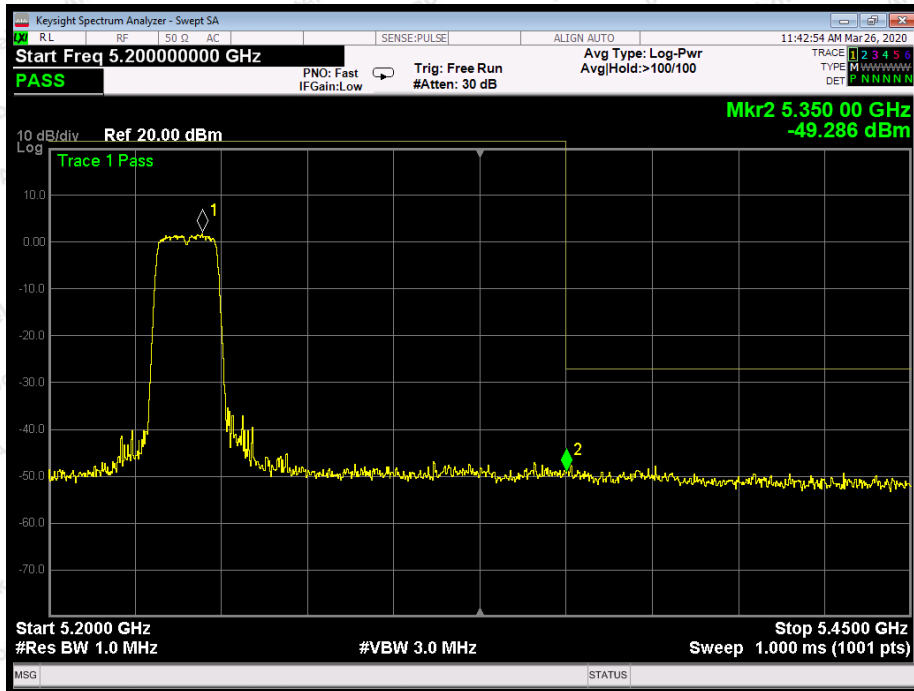

802.11n(20): Band Edge, Right Side

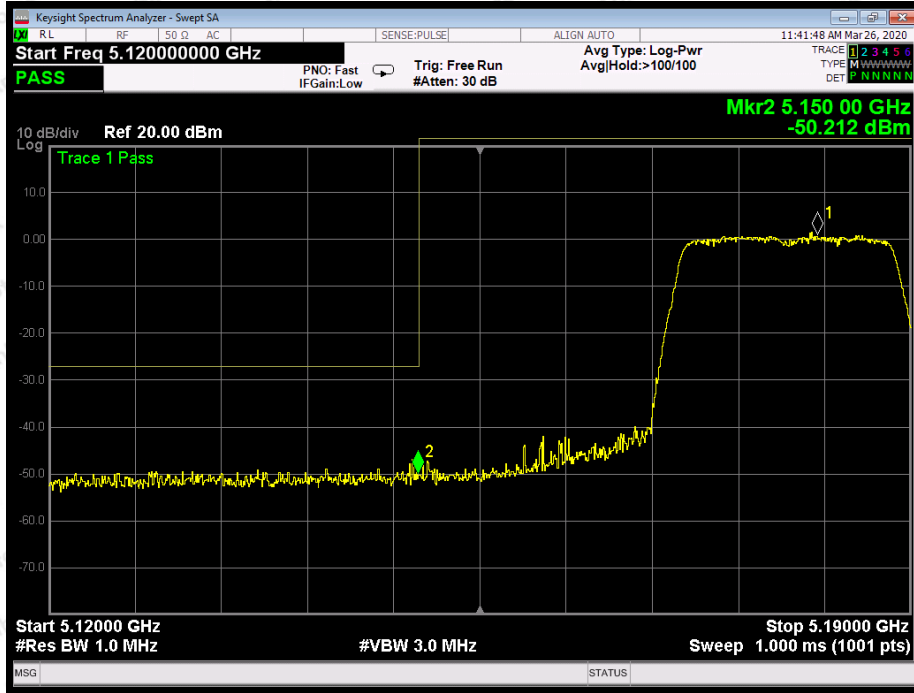

802.11ac(20): Band Edge, Left Side

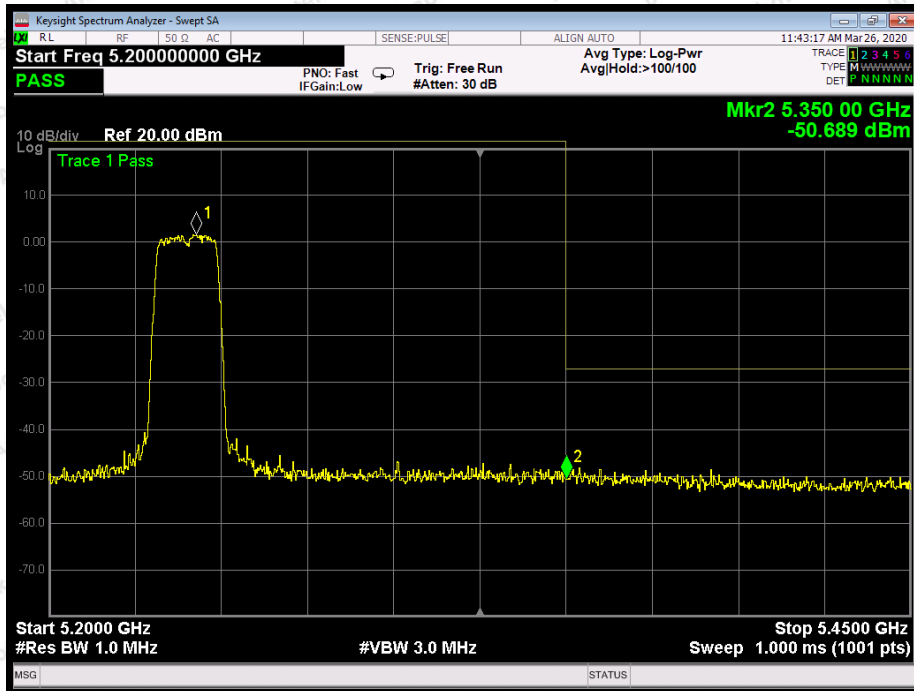

802.11ac(20): Band Edge, Right Side



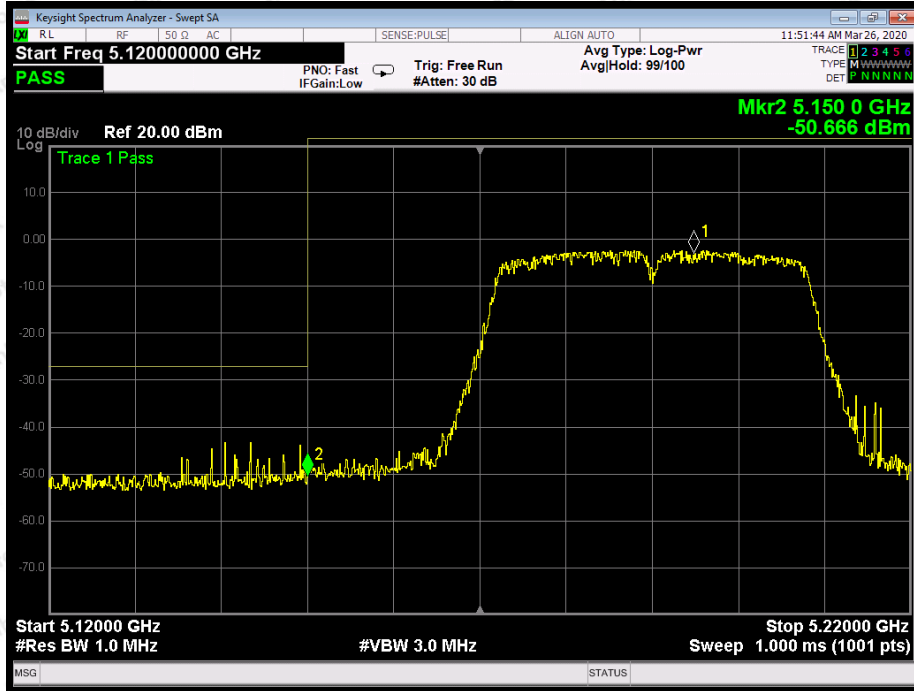

802.11n(40): Band Edge, Left Side

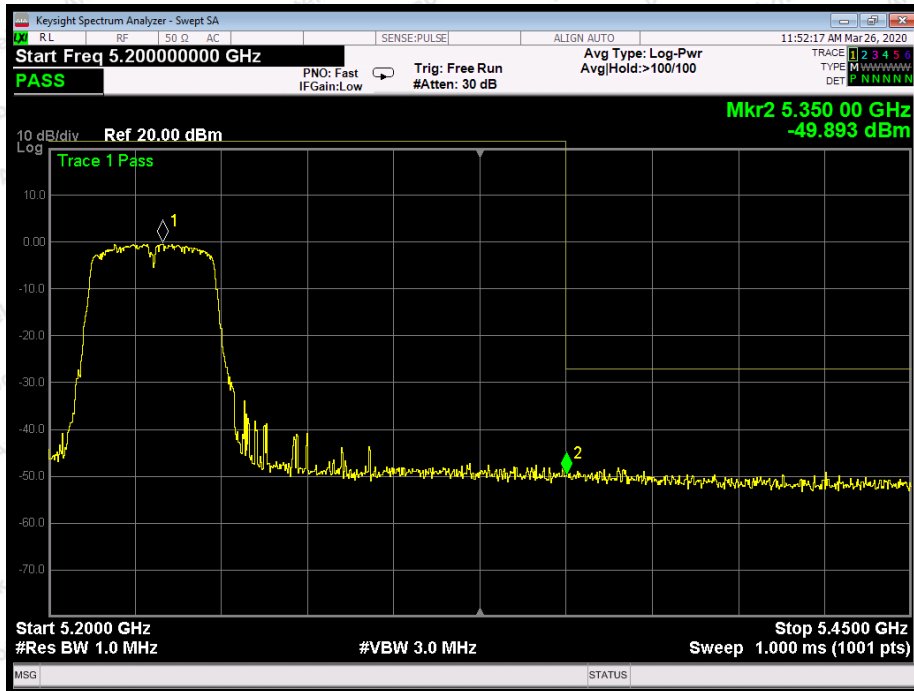

802.11n(40): Band Edge, Right Side

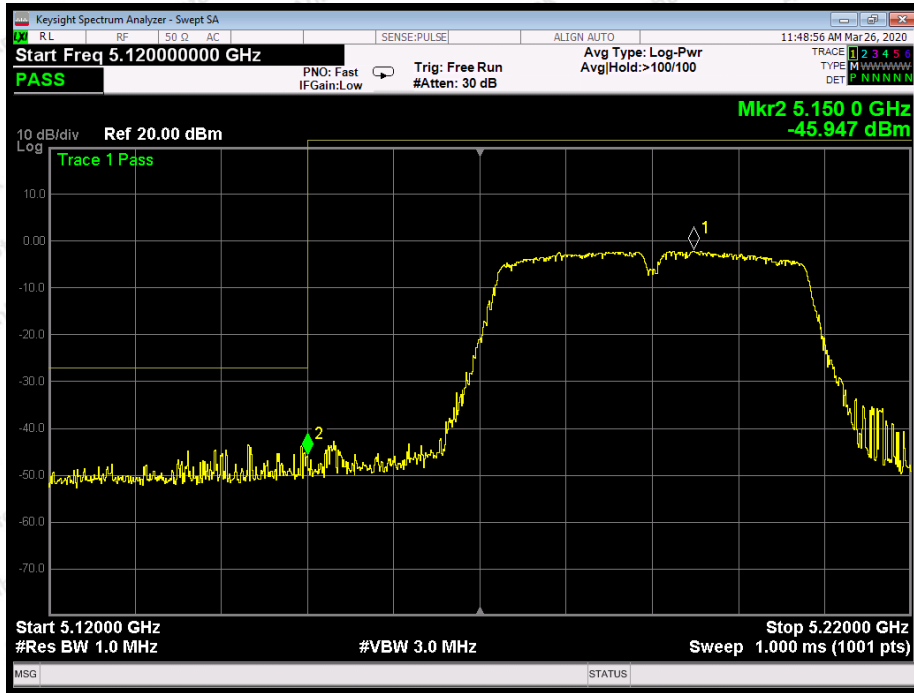

802.11ac(40): Band Edge, Left Side

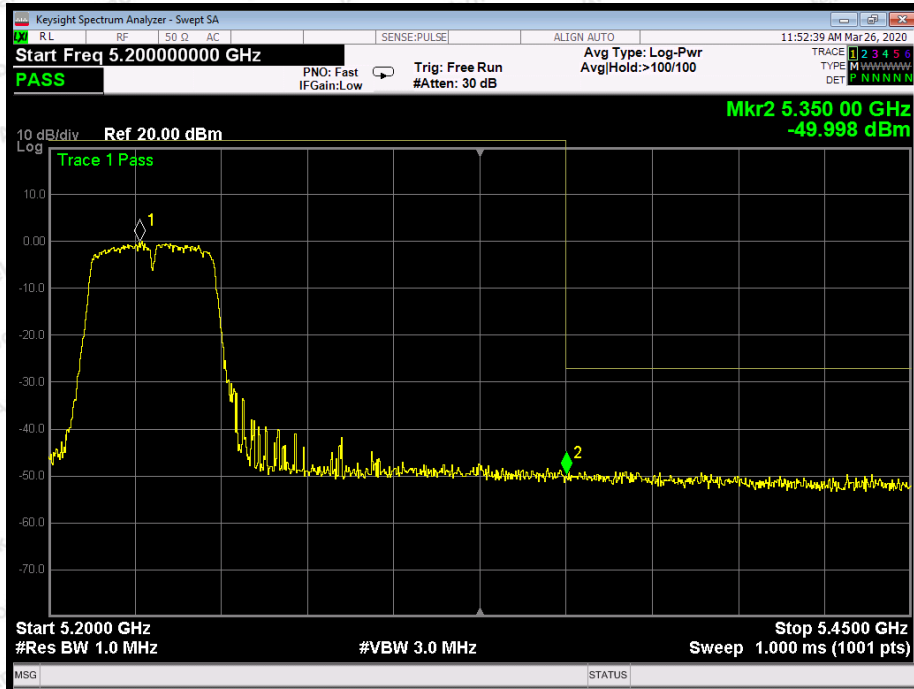

802.11ac(40): Band Edge, Right Side

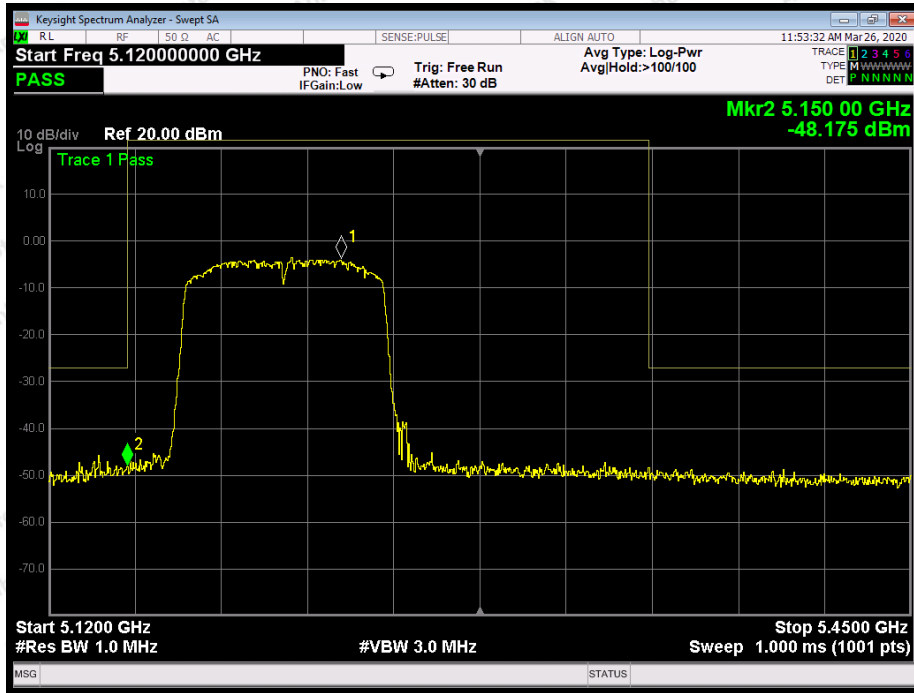

802.11ac(80): Band Edge

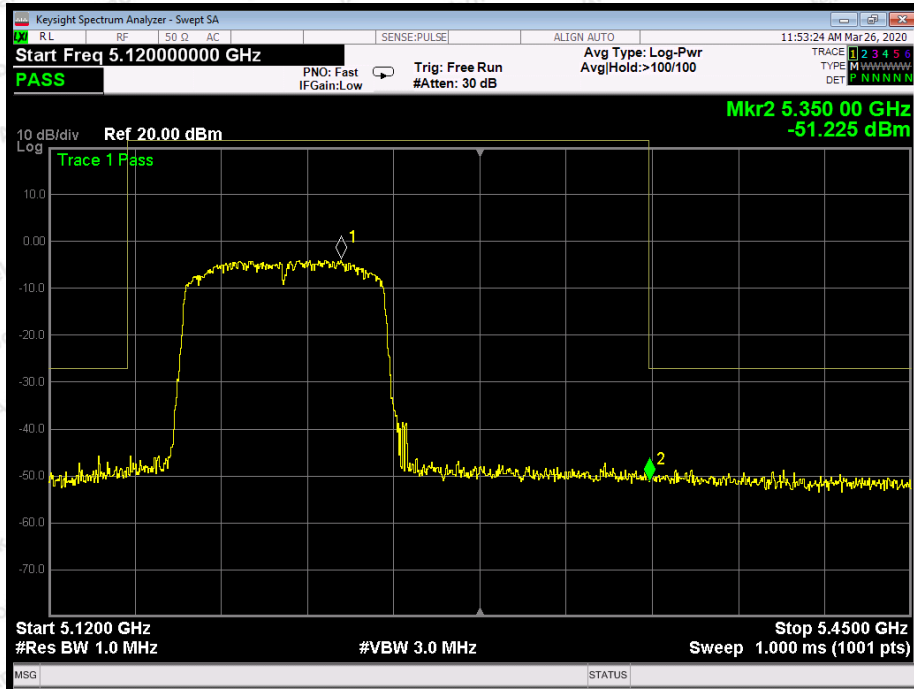

802.11ac(80): Band Edge

Remark: 1.the plots provided now is the worst case



## 5. Maximum Peak Output Power Test

### 5.1. Test Standard and Limit

Test Standard	FCC Part15 C Section 15.407 (a) (1) (iv)
Test Limit	24dBm

### 5.2. Test Setup

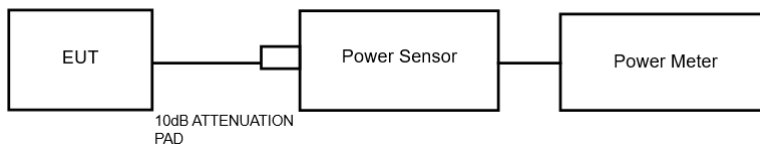

### 5.3. Test Procedure

1. The Transmitter output (antenna port) was connected to the power meter.
2. Turn on the EUT and power meter and then record the power value.
3. Repeat above procedures on all channels needed to be tested.

Note: The cable loss and attenuator loss were offset into measure device as an amplitude offset.

### 5.4. Test Data

Test Item	: Max. peak output power	Test Mode	: CH Low ~ CH High
Test Voltage	: AC 120V, 60Hz for adapter	Temperature	: 24°C
Test Result	: PASS	Humidity	: 55%RH

ANT A

Mode	Channel Frequency (MHz)	Peak Power output (dBm)	Correctional Limit (dBm)	Results
802.11a	5180	11.90	24	PASS
	5200	11.89	24	PASS
	5240	12.37	24	PASS
802.11n20	5180	11.55	24	PASS
	5200	11.63	24	PASS
	5240	12.14	24	PASS
802.11ac20	5180	11.74	24	PASS
	5200	12.14	24	PASS
	5240	12.40	24	PASS
802.11n40	5190	11.48	24	PASS
	5230	12.25	24	PASS
802.11ac40	5190	12.01	24	PASS
	5230	12.71	24	PASS
802.11ac80	5210	<b>12.62</b>	24	PASS

ANT B

Mode	Channel Frequency (MHz)	Peak Power output (dBm)	Correctional Limit (dBm)	Results
802.11a	5180	11.76	24	PASS
	5200	11.71	24	PASS
	5240	12.40	24	PASS
802.11n20	5180	11.95	24	PASS
	5200	11.94	24	PASS
	5240	12.13	24	PASS
802.11ac20	5180	11.57	24	PASS
	5200	11.60	24	PASS
	5240	12.28	24	PASS
802.11n40	5190	12.02	24	PASS
	5230	12.25	24	PASS
802.11ac40	5190	12.01	24	PASS
	5230	11.96	24	PASS
802.11ac80	5210	12.51	24	PASS



ANT A+ANT B

Mode	Channel Frequency (MHz)	Peak Power output (dBm)	Correctional Limit (dBm)	Results
802.11n20	5180	14.76	24	PASS
	5200	14.80	24	PASS
	5240	15.15	24	PASS
802.11ac20	5180	14.67	24	PASS
	5200	14.89	24	PASS
	5240	15.35	24	PASS
802.11n40	5190	14.77	24	PASS
	5230	15.26	24	PASS
802.11ac40	5190	15.02	24	PASS
	5230	15.36	24	PASS
802.11ac80	5210	15.58	24	PASS

Note: The EUT is Belongs to 15.407 (a) (1) (iv)

## 6. Occupy Bandwidth Test

### 6.1. Test Standard

Test Standard	FCC Part15 C Section 15.407 (a)(5)
---------------	------------------------------------

### 6.2. Test Setup

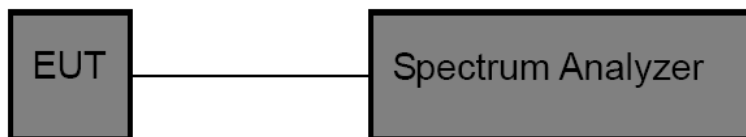

### 6.3. Test Procedure

1. Place the EUT on the table and set it in the transmitting mode.
2. Remove the antenna from the EUT and then connect a low loss RF cable from the antenna port to the spectrum analyzer.

3. Set the spectrum analyzer as:

#### 26 dB & 99% bandwidth

RBW = approximately 1% of the emission bandwidth;

Set the VBW > RBW;

Detector= Peak

Trace mode= Max hold.

Sweep- auto couple.

#### 6 dB bandwidth

RBW = 100kHz;

Set the video bandwidth (VBW) ≥ 3 RBW;

Detector= Peak

Trace mode= Max hold.

Sweep- auto couple.

4. Measure the maximum width of the emission that is 26dB /6dB down from the maximum of the emission. Compare this with the RBW setting of the analyzer.

5. Repeat until all the rest channels are investigated.

### 6.4. Test Data

Test Item	: 6dB &26dB BW	Test Mode	: CH Low ~ CH High
Test Voltage	: AC 120V, 60Hz for adapter	Temperature	: 24°C
Test Result	: PASS	Humidity	: 55%RH

ANT A

Mode	Channel Frequency (MHz)	6dB BW(MHz)	Limit	Results
802.11a	5180	16.34	>0.5MHz	PASS
	5200	16.36		PASS
	5240	16.37		PASS
802.11n20	5180	17.17		PASS
	5200	17.58		PASS
	5240	17.10		PASS
802.11ac20	5180	17.57		PASS
	5200	17.60		PASS
	5240	17.60		PASS
802.11n40	5190	35.25		PASS
	5230	35.18		PASS
802.11ac40	5190	35.20		PASS
	5230	35.42		PASS
802.11ac80	5210	75.24		PASS

Mode	Channel Frequency (MHz)	26dB BW(MHz)	99% Bandwidth (MHz)
802.11a	5180	18.57	16.346
	5200	18.63	16.354
	5240	18.50	16.365
802.11n20	5180	19.30	17.552
	5200	19.32	17.539
	5240	19.22	17.537
802.11ac20	5180	19.33	17.527
	5200	19.44	17.546
	5240	19.53	17.504
802.11n40	5190	40.40	35.993
	5230	40.69	36.114
802.11ac40	5190	40.79	36.104
	5230	40.80	36.144
802.11ac80	5210	81.19	74.634



ANT B

Mode	Channel Frequency (MHz)	6dB BW(MHz)	Limit	Results
802.11a	5180	16.33	>0.5MHz	PASS
	5200	16.36		PASS
	5240	16.38		PASS
802.11n20	5180	17.15		PASS
	5200	17.60		PASS
	5240	16.98		PASS
802.11ac20	5180	17.00		PASS
	5200	17.57		PASS
	5240	17.60		PASS
802.11n40	5190	35.19		PASS
	5230	35.28		PASS
802.11ac40	5190	35.23		PASS
	5230	35.16		PASS
802.11ac80	5210	75.16		PASS

Mode	Channel Frequency (MHz)	26dB BW(MHz)	99% Bandwidth (MHz)
802.11a	5180	18.54	16.338
	5200	18.22	16.340
	5240	18.34	16.342
802.11n20	5180	19.36	17.542
	5200	19.39	17.546
	5240	19.37	17.555
802.11ac20	5180	19.40	17.535
	5200	19.50	17.555
	5240	19.37	17.538
802.11n40	5190	40.83	36.067
	5230	41.24	36.193
802.11ac40	5190	40.73	36.108
	5230	40.74	36.051
802.11ac80	5210	81.95	74.770

**6dB Bandwidth**

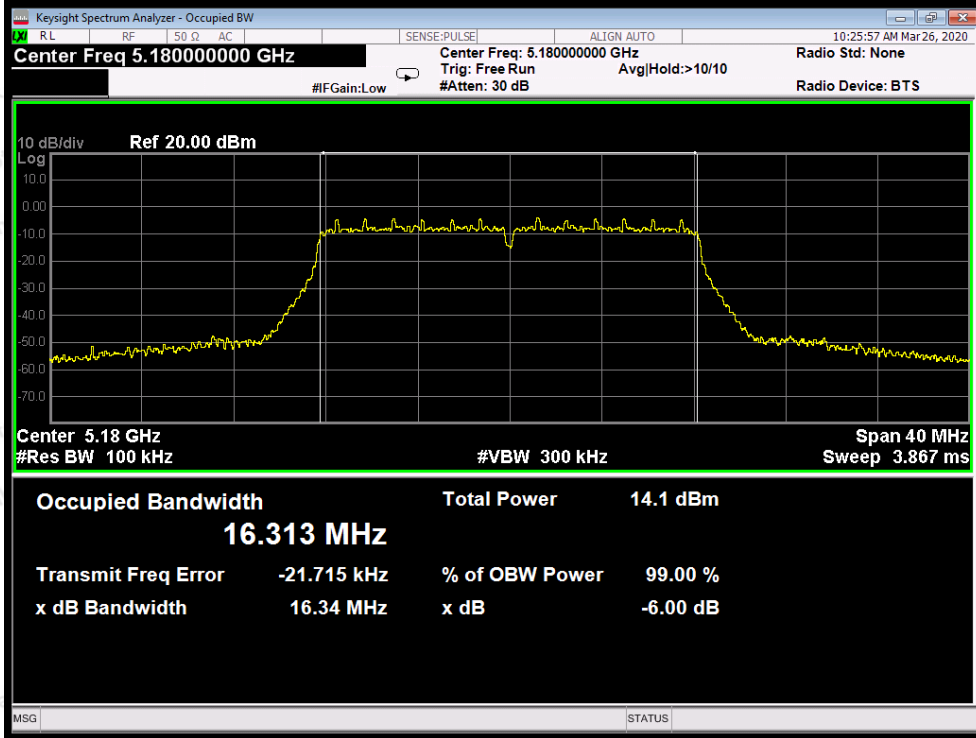

Test Mode: 802.11a--Low

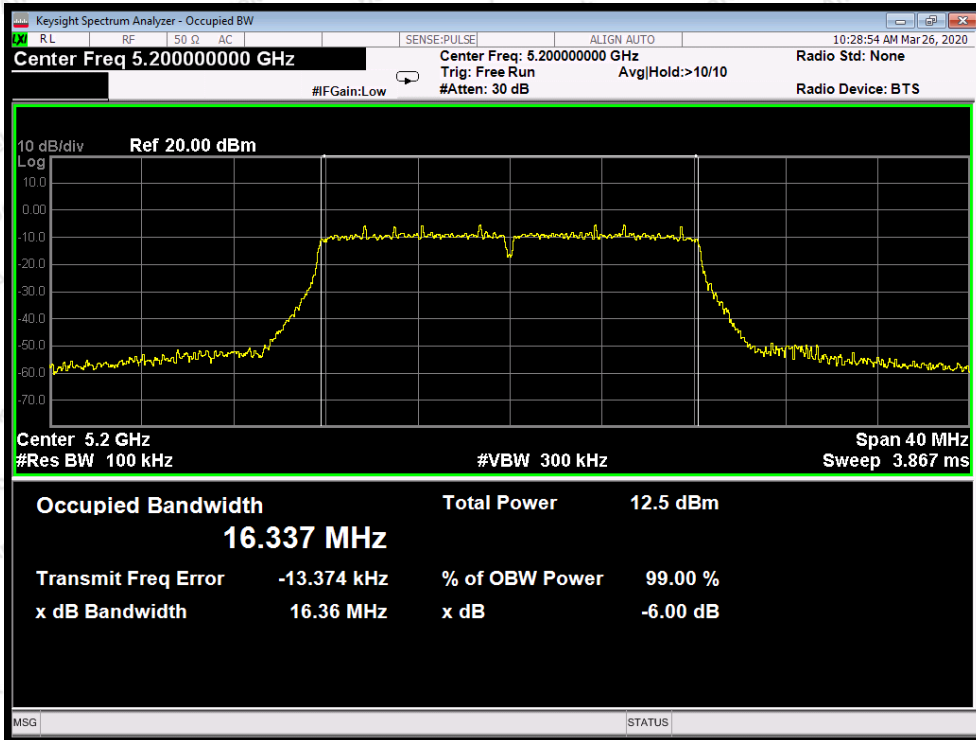

Test Mode: 802.11a---Middle

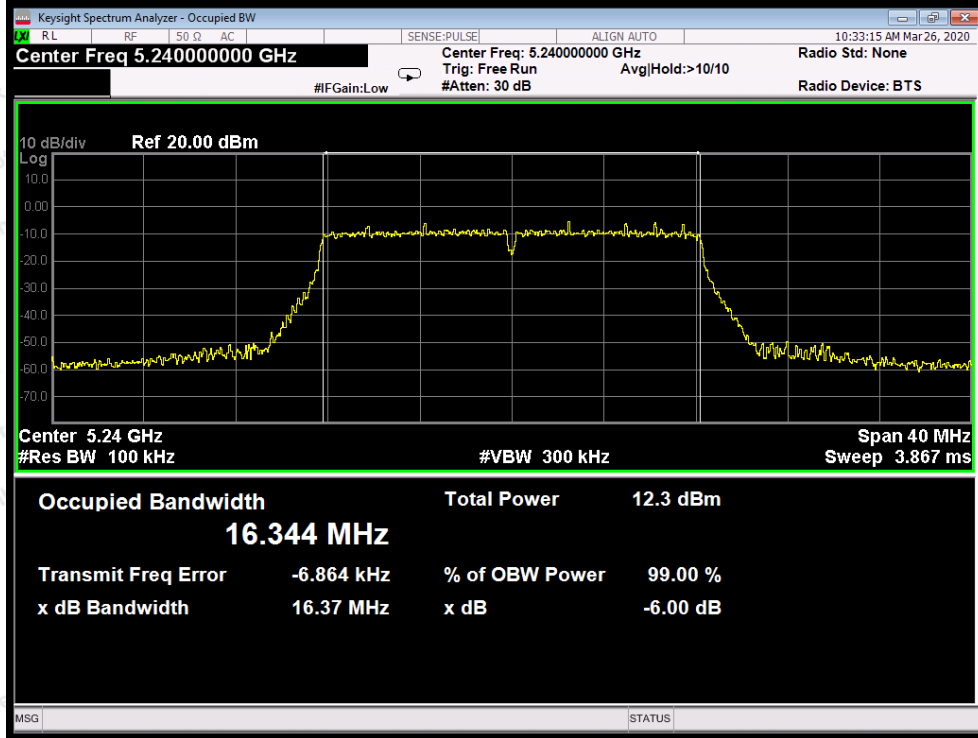

Test Mode: 802.11a---High

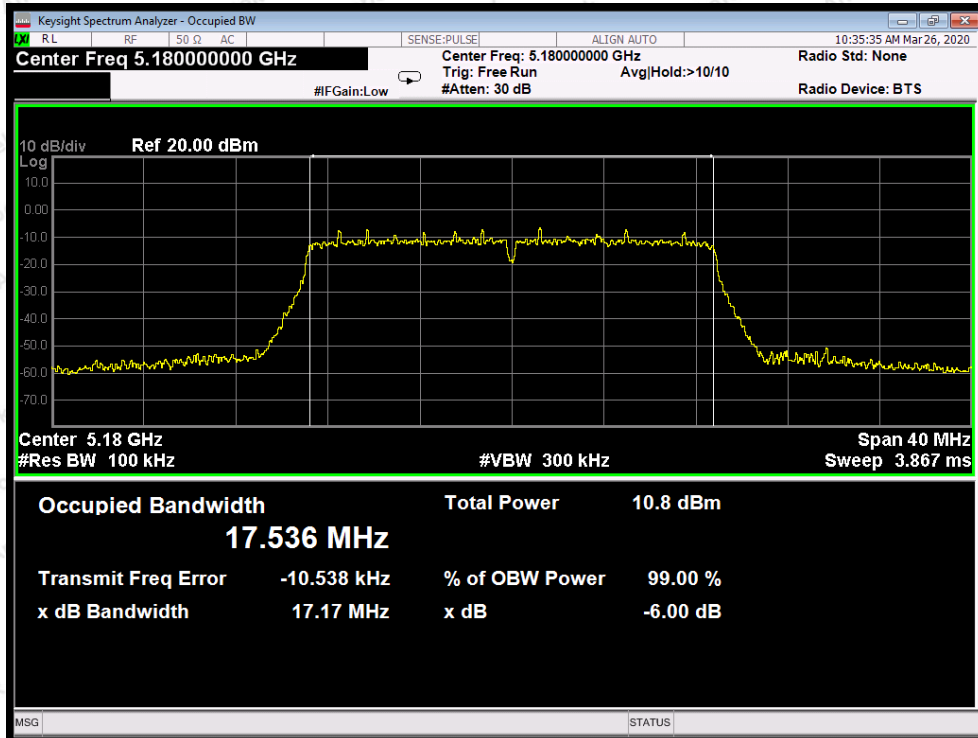

Test Mode: 802.11n20---Low



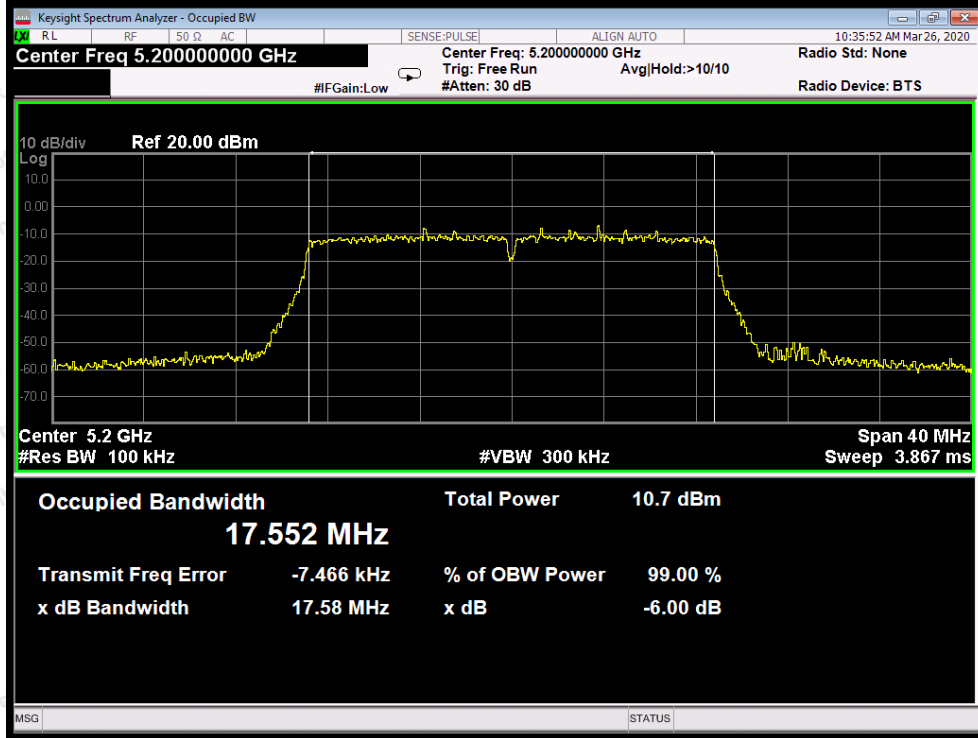

Test Mode: 802.11n20---Middle

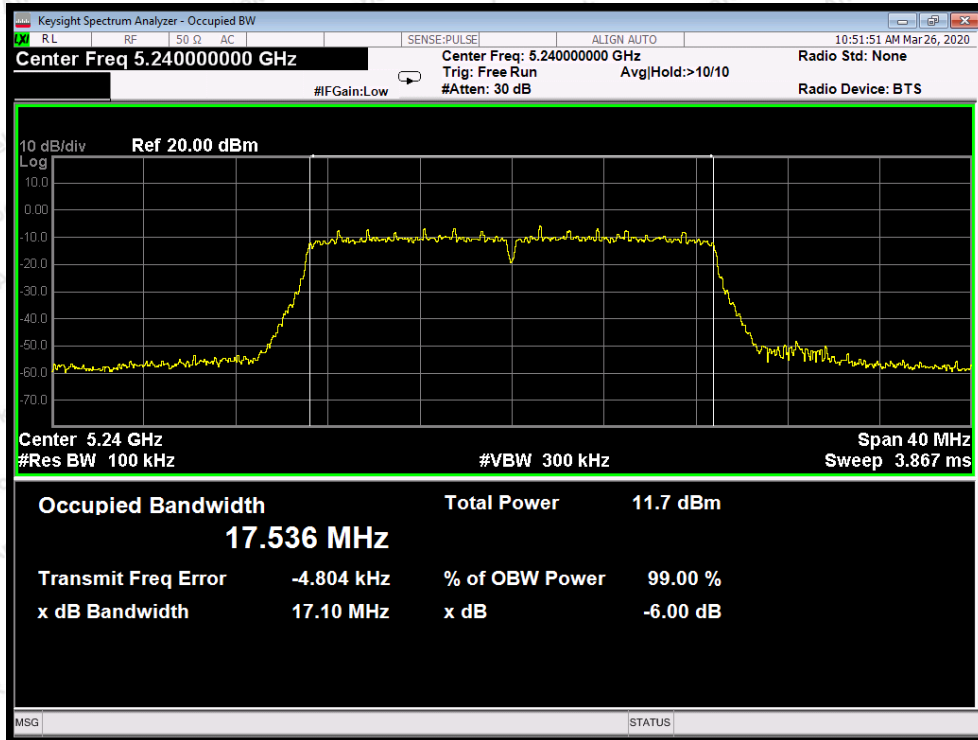

Test Mode: 802.11n20---High

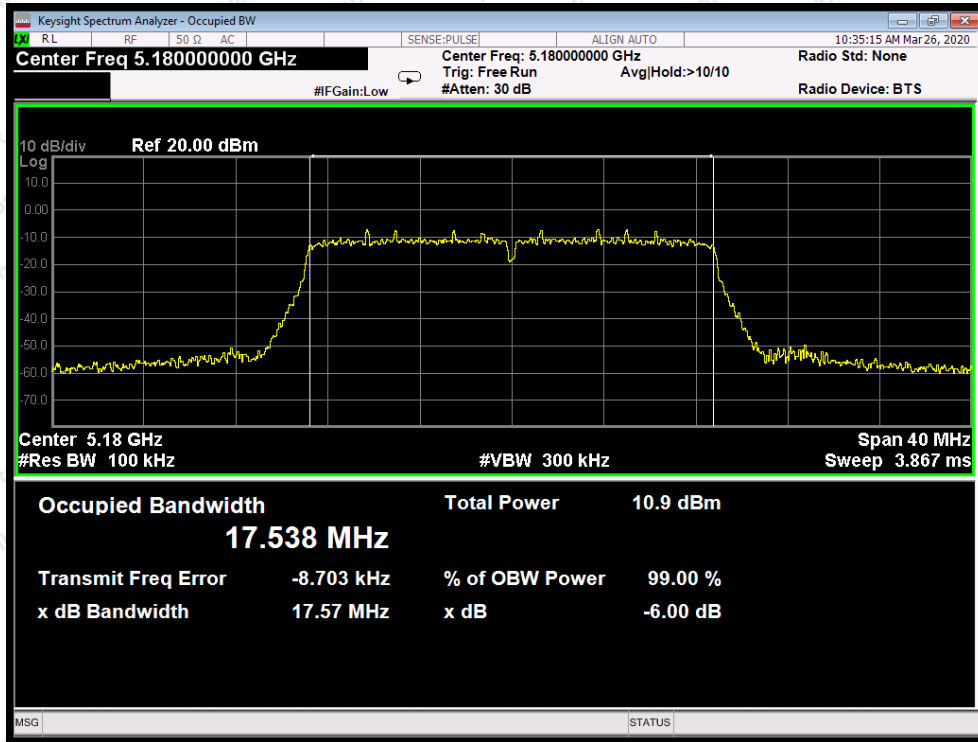

Test Mode: 802.11ac20--Low

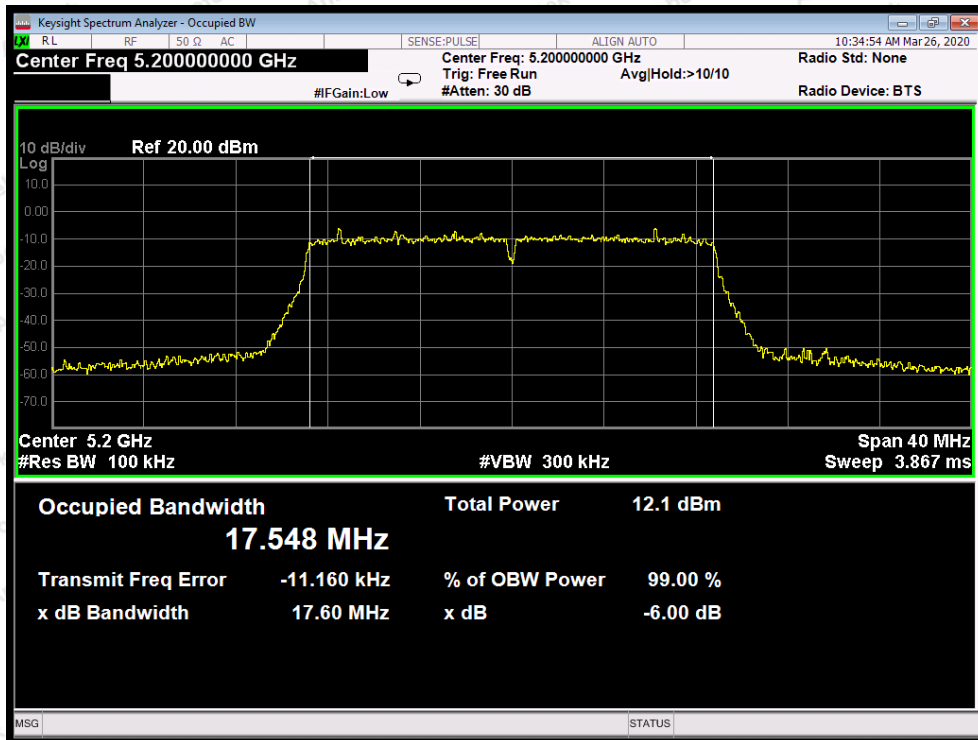

Test Mode: 802.11ac20---Middle

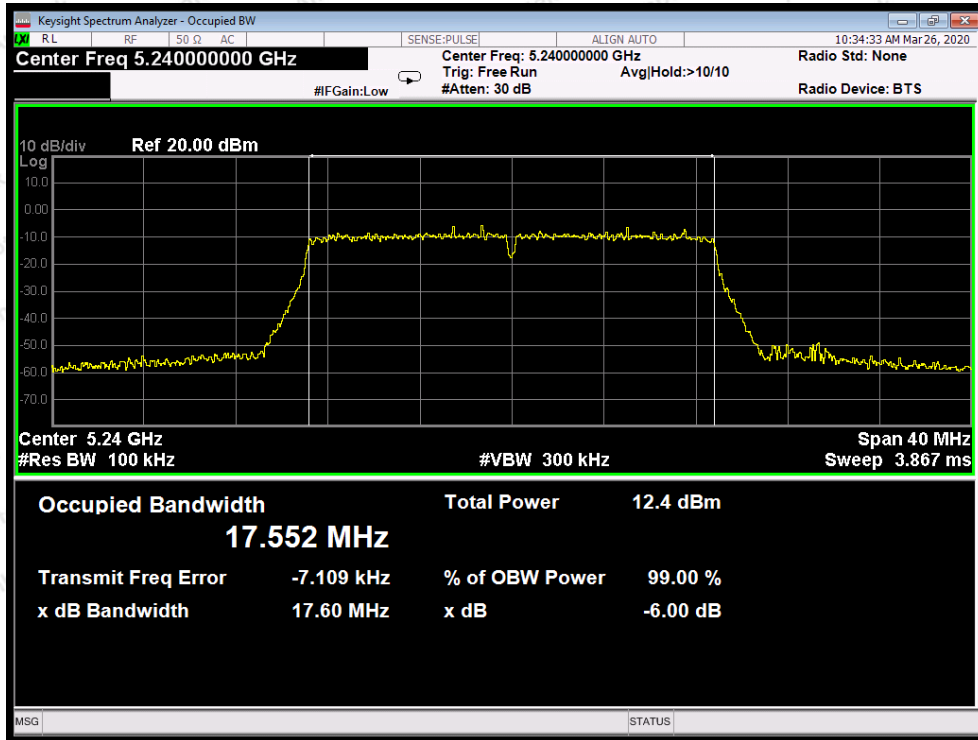

Test Mode: 802.11ac20---High

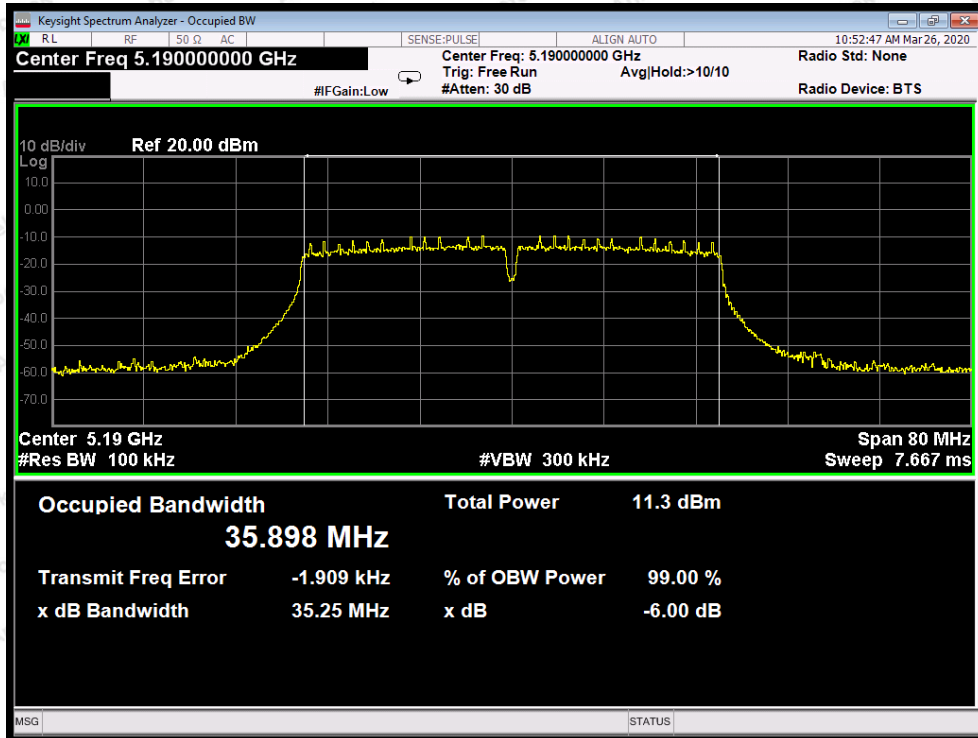

Test Mode: 802.11n40---Low



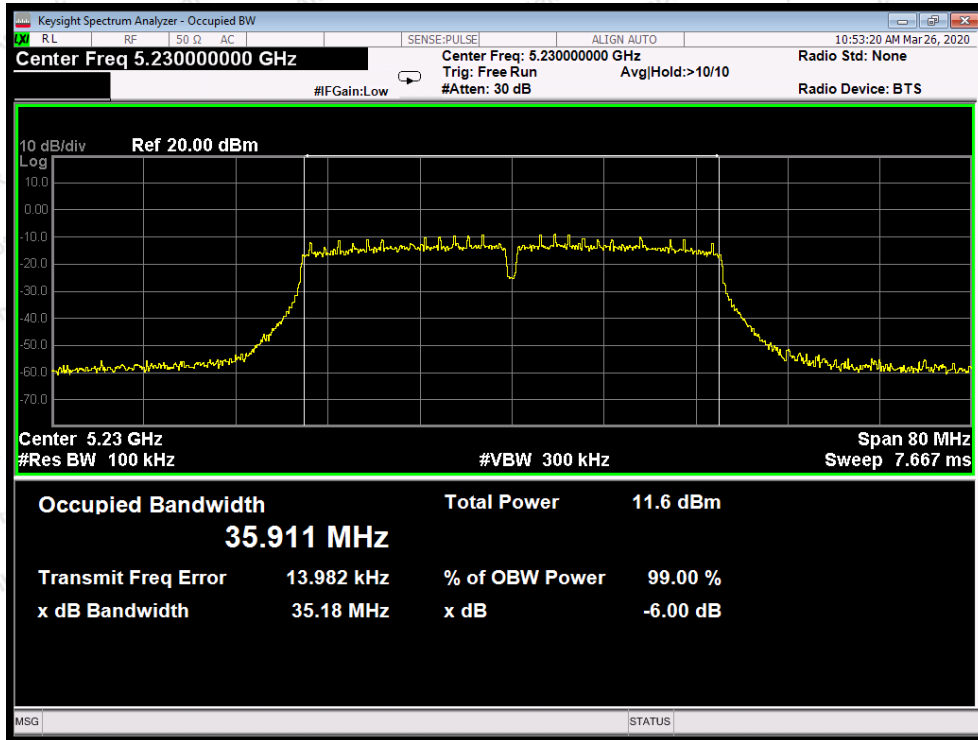

Test Mode: 802.11n40---High

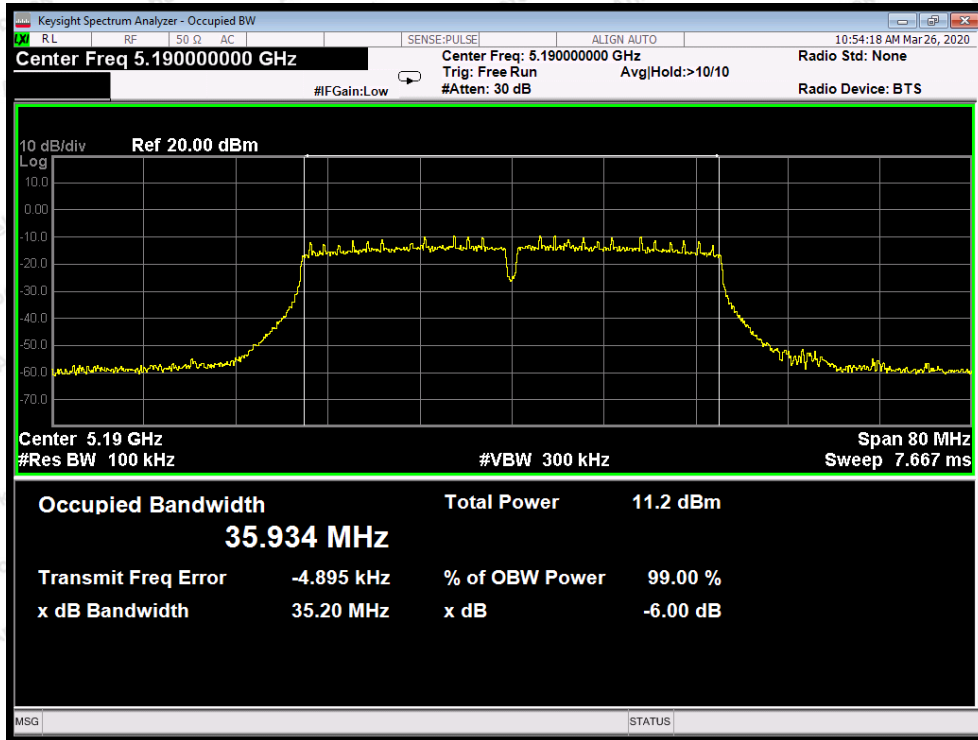

Test Mode: 802.11ac40---Low

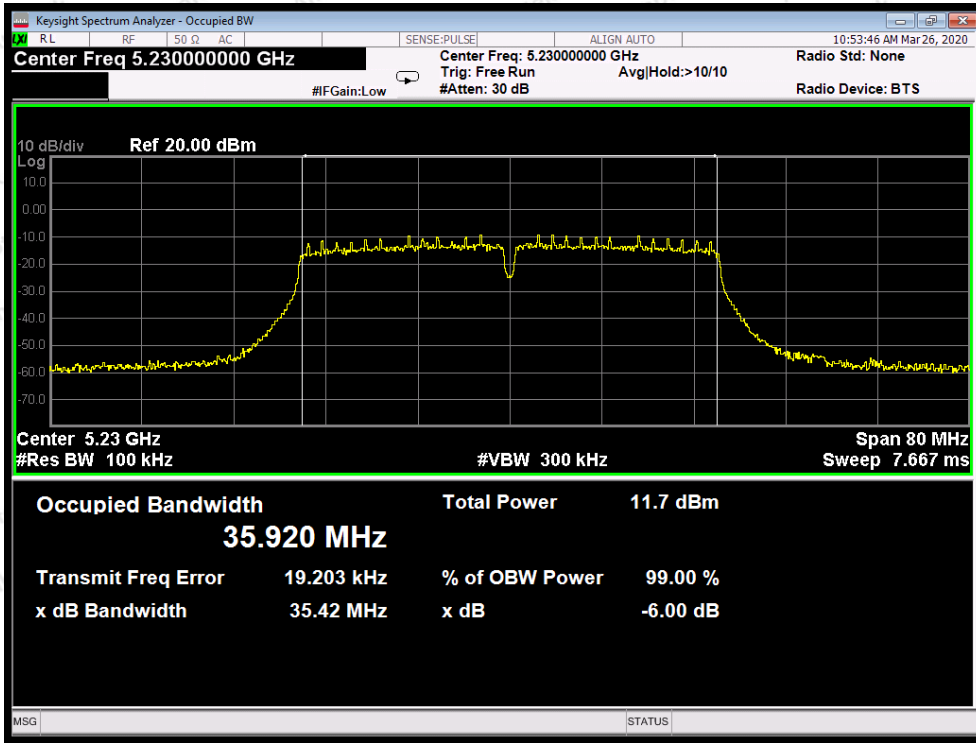

Test Mode: 802.11ac40---High

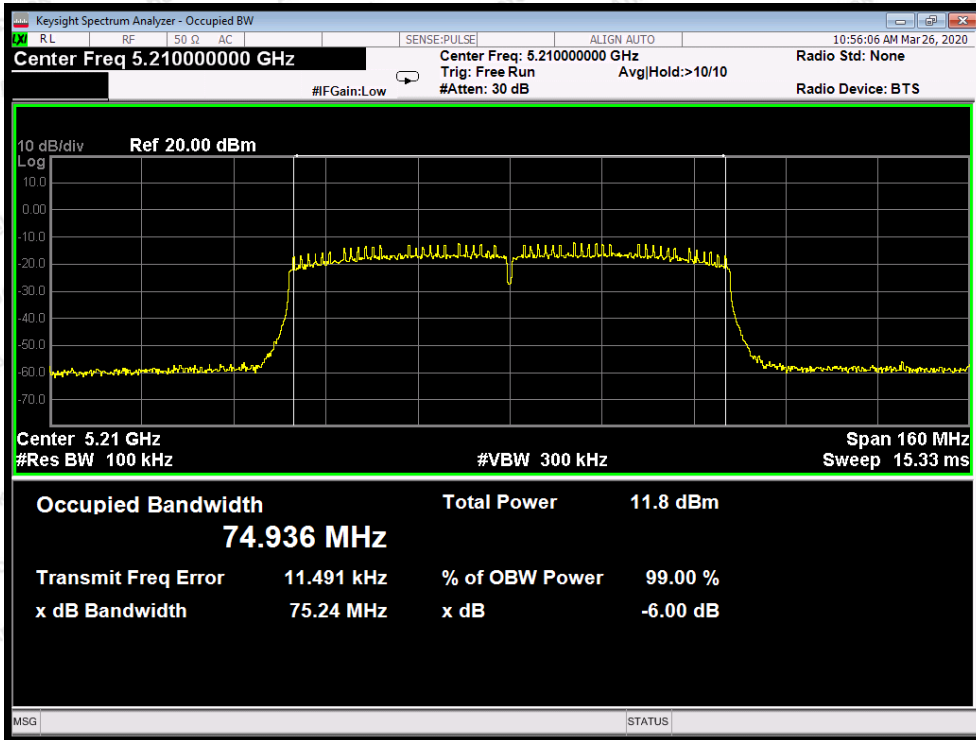

Test Mode: 802.11ac80

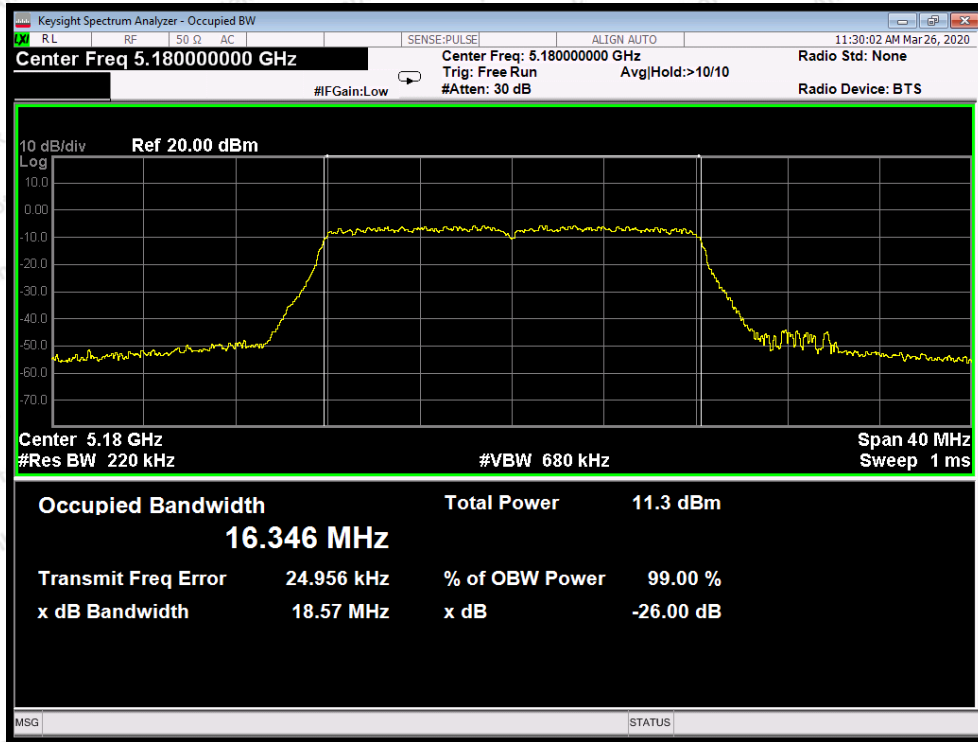

Test Mode: 802.11a--Low

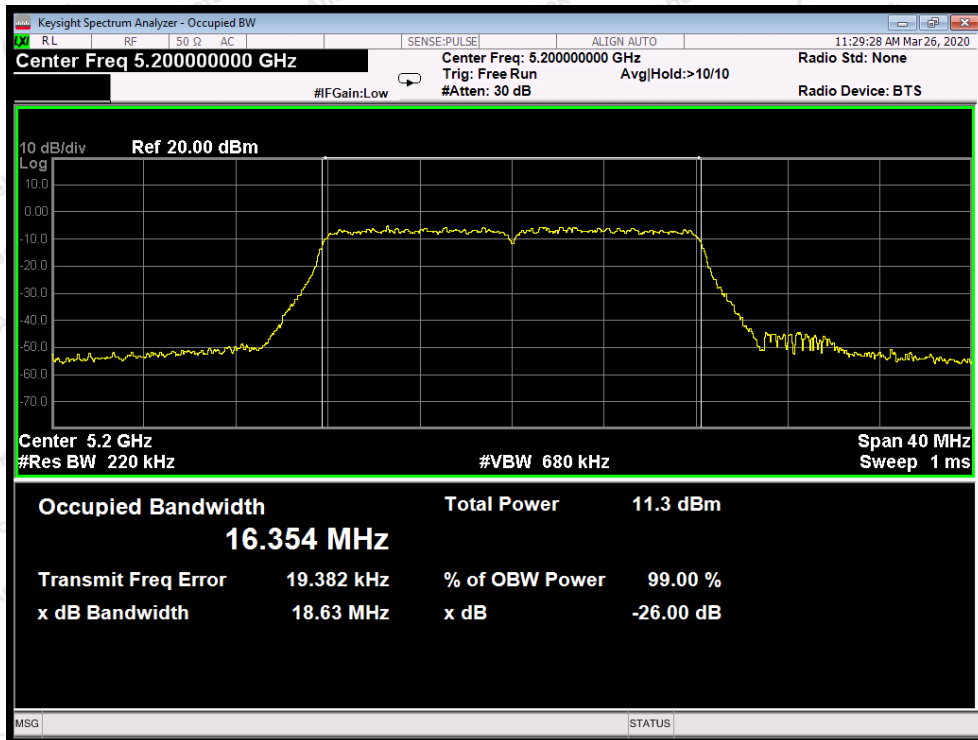

Test Mode: 802.11a--Middle



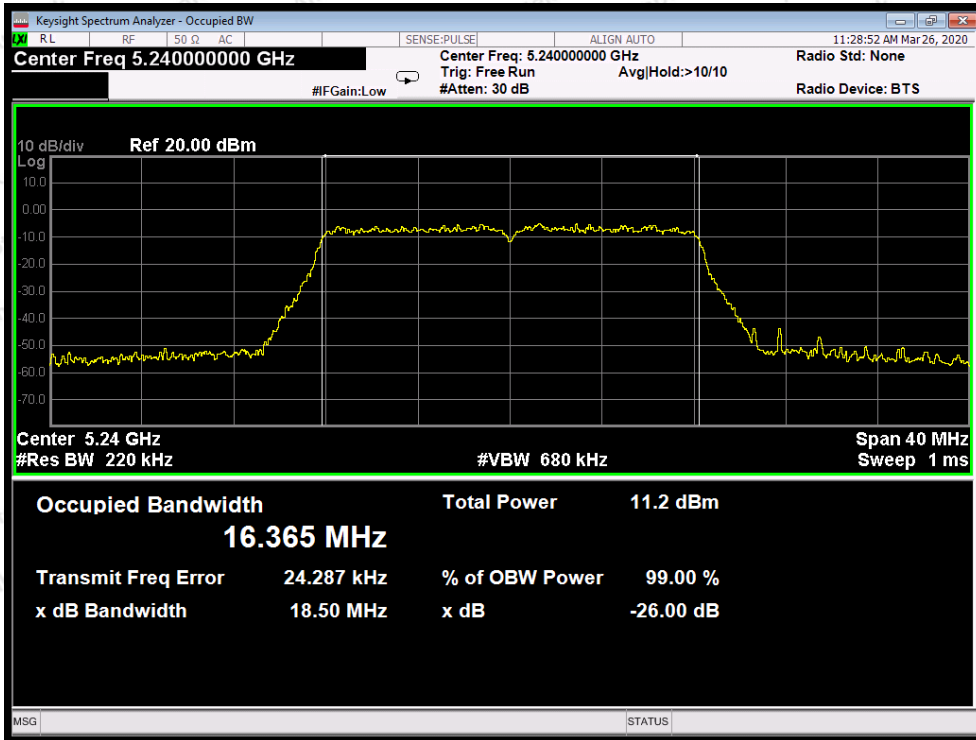

Test Mode: 802.11a---High

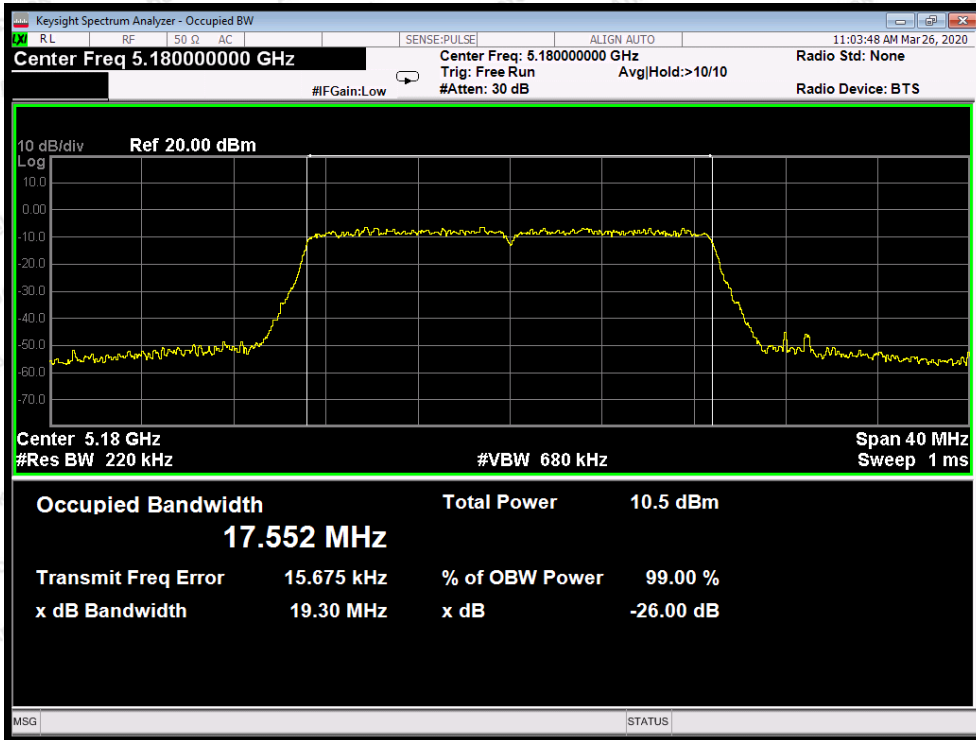

Test Mode: 802.11n20---Low

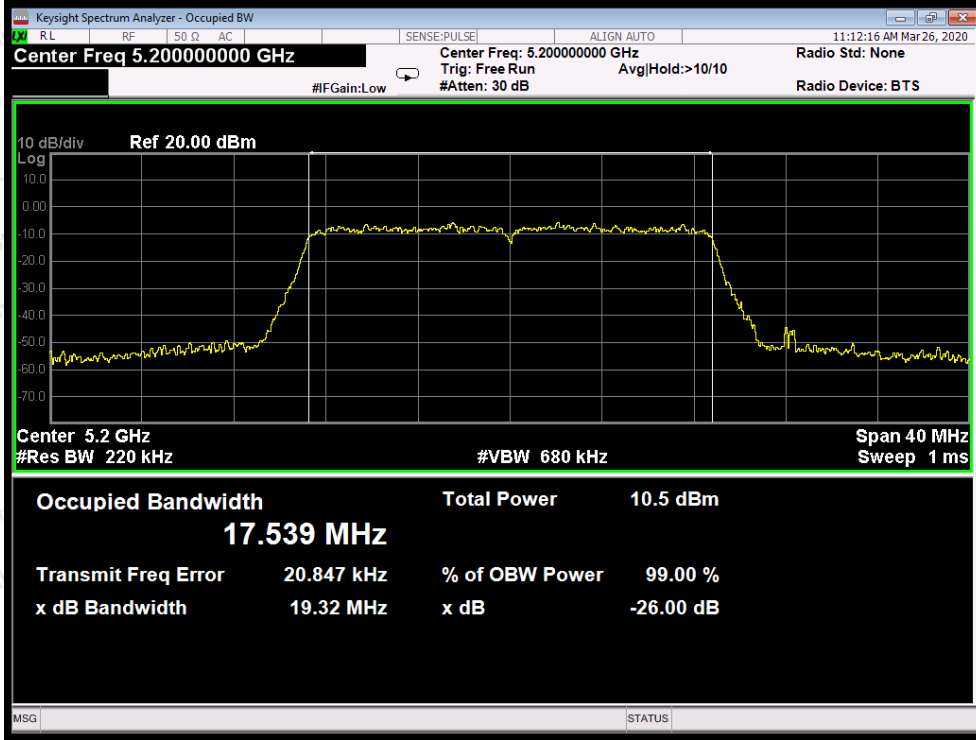

Test Mode: 802.11n20---Middle

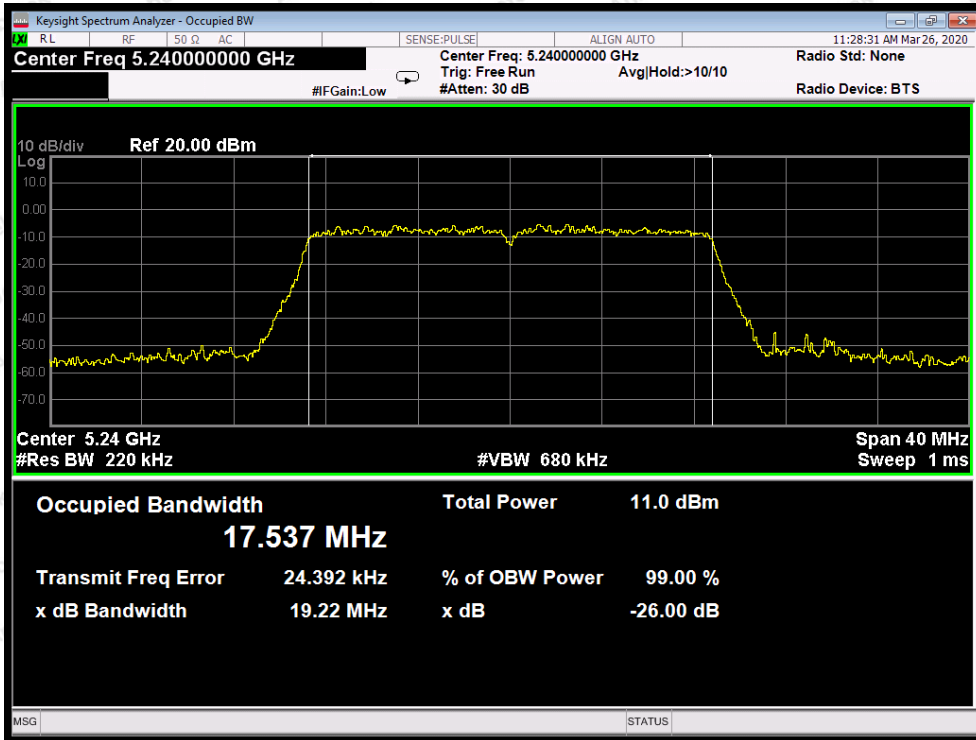

Test Mode: 802.11n20---High

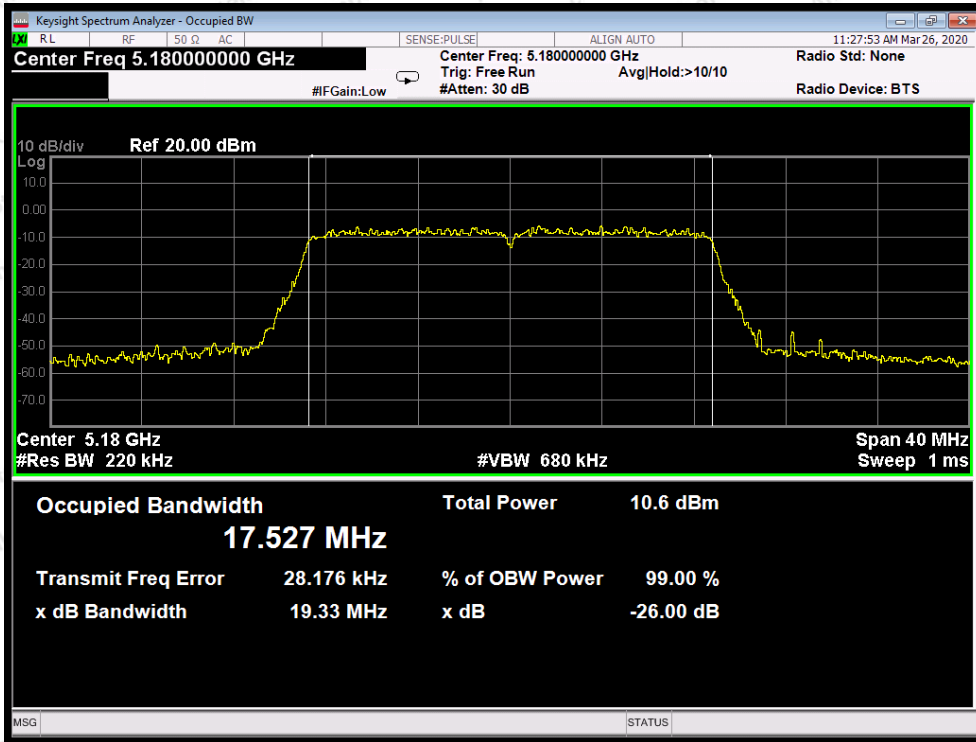

Test Mode: 802.11ac20--Low

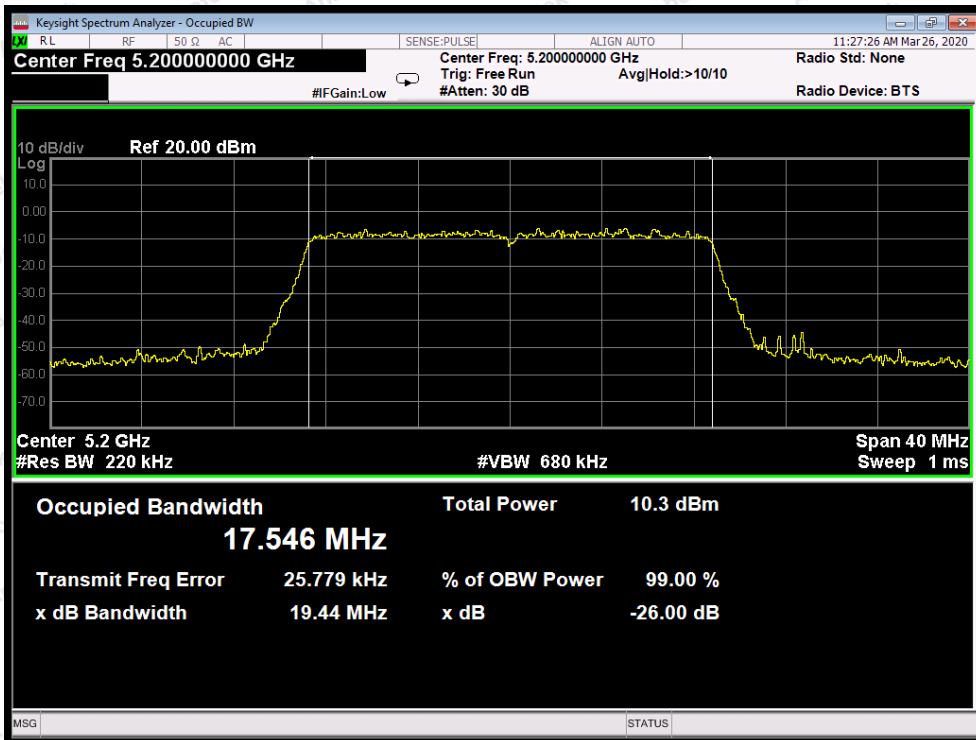

Test Mode: 802.11ac20---Middle



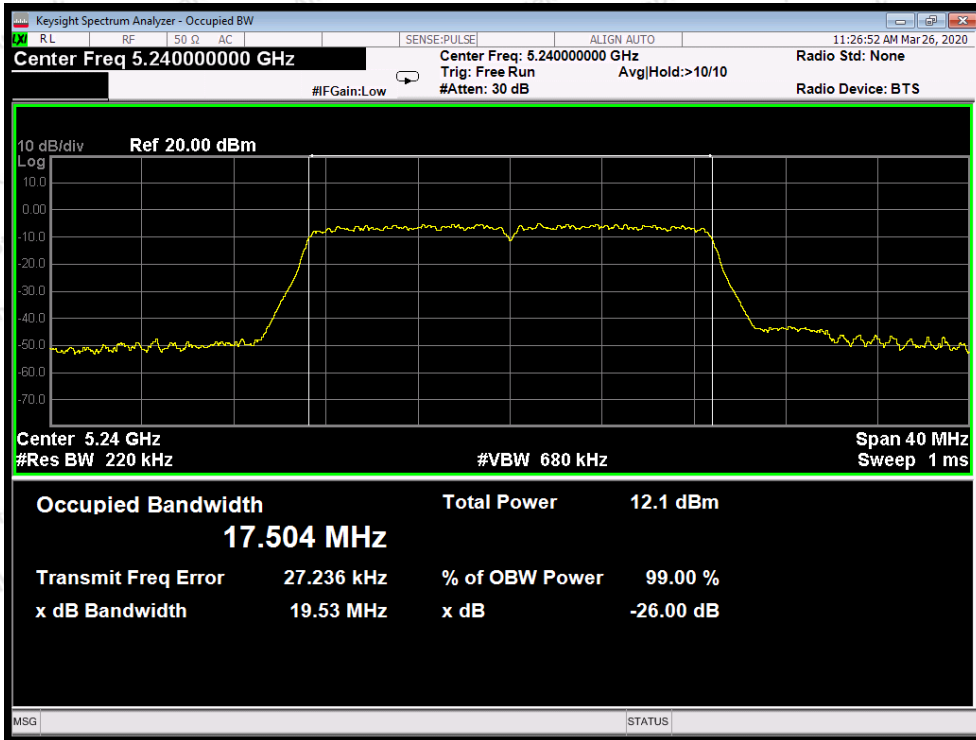

Test Mode: 802.11ac20---High

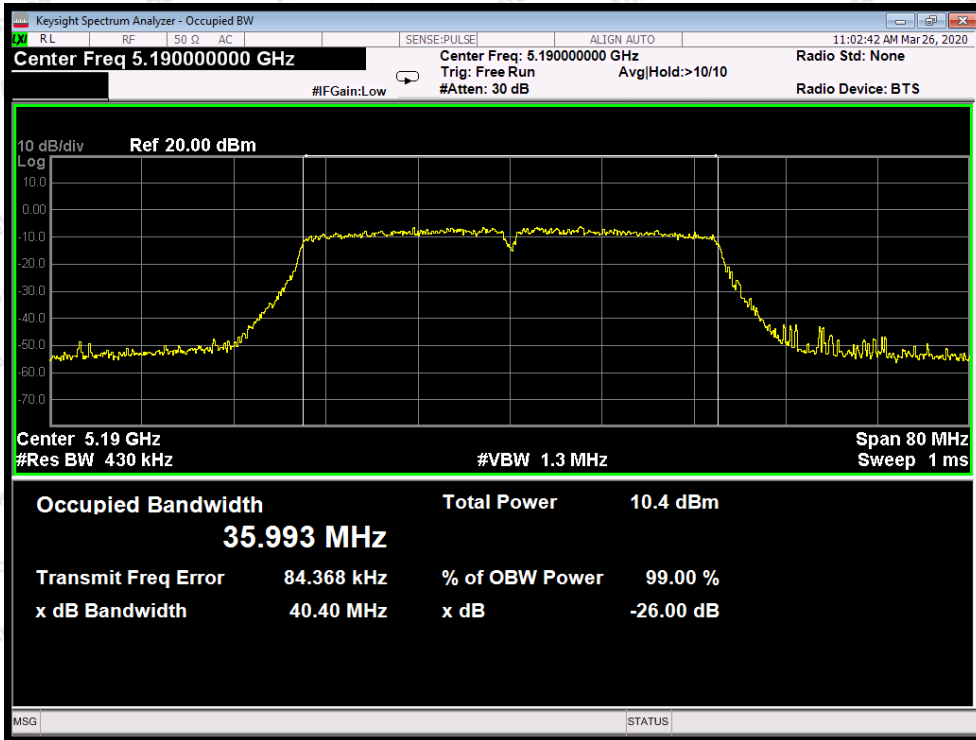

Test Mode: 802.11n40---Low

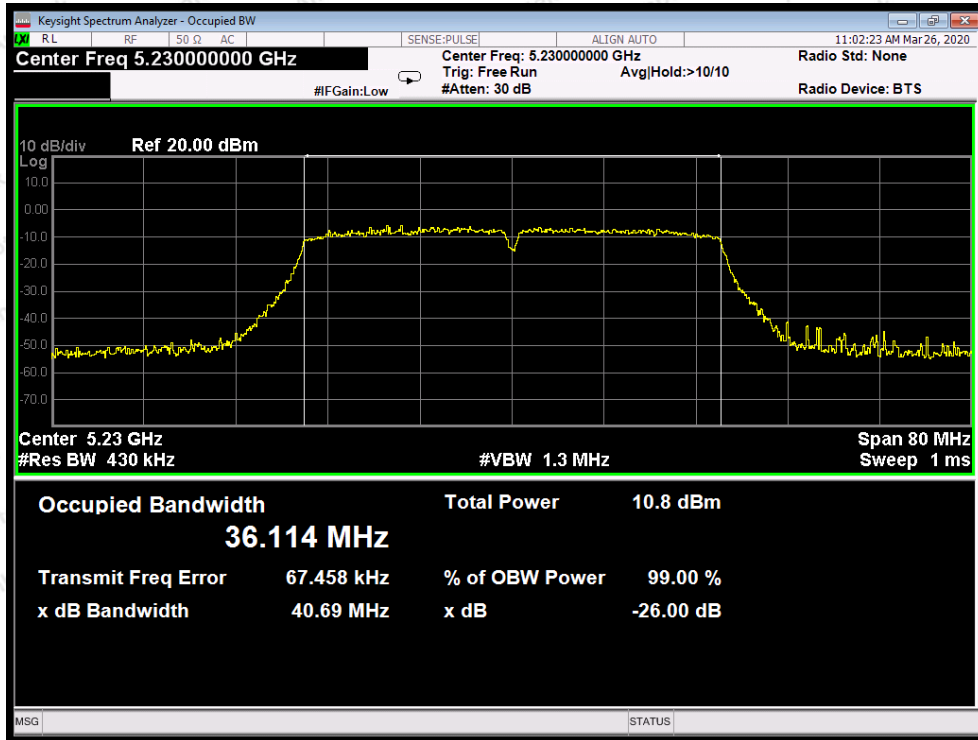

Test Mode: 802.11n40---High

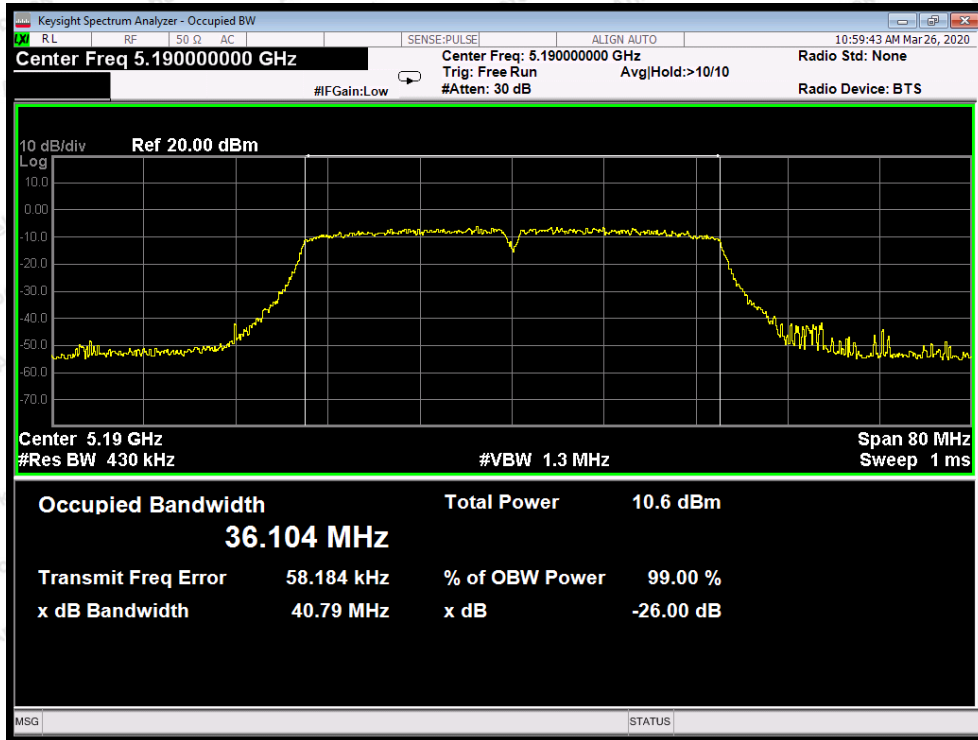

Test Mode: 802.11ac40---Low

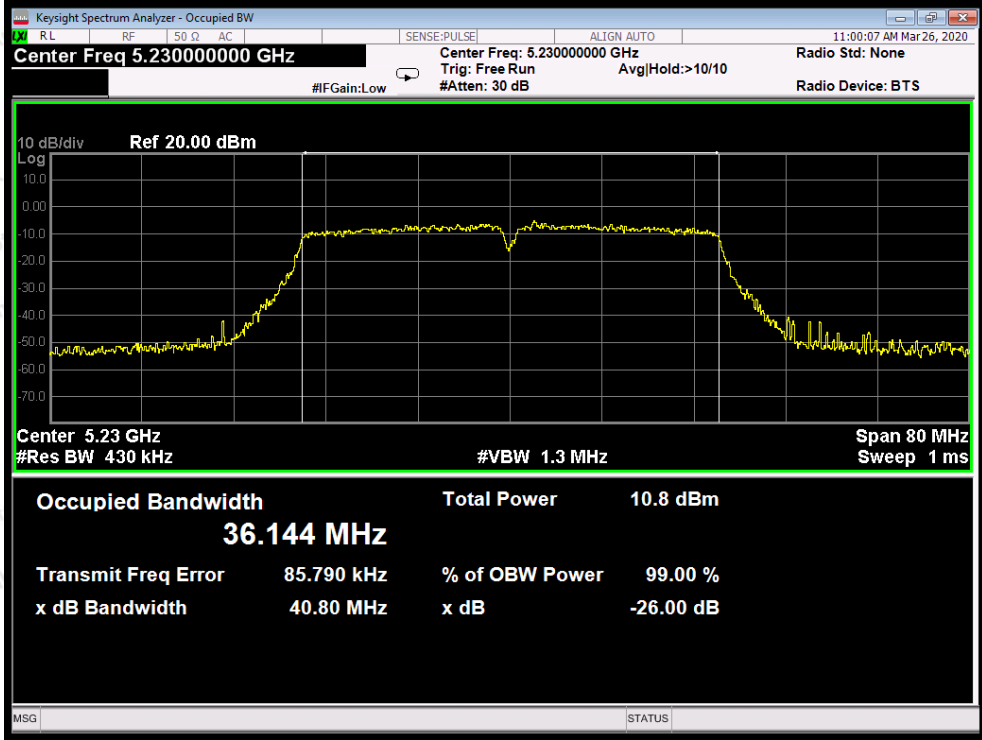

Test Mode: 802.11ac40---High

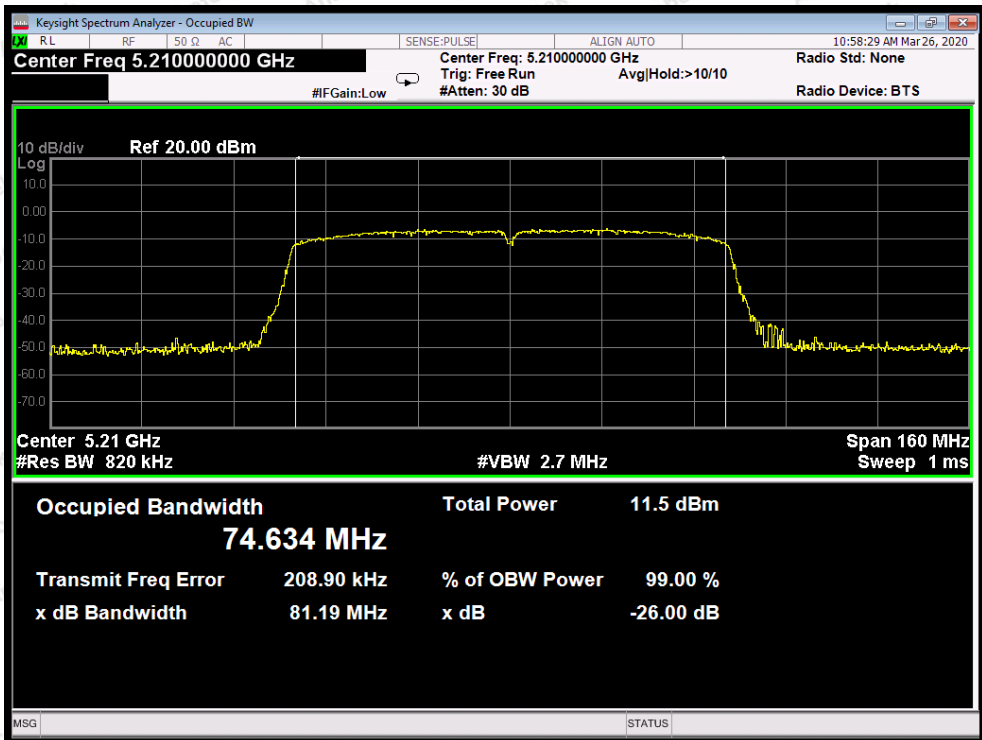

Test Mode: 802.11ac80



**6dB Bandwidth**

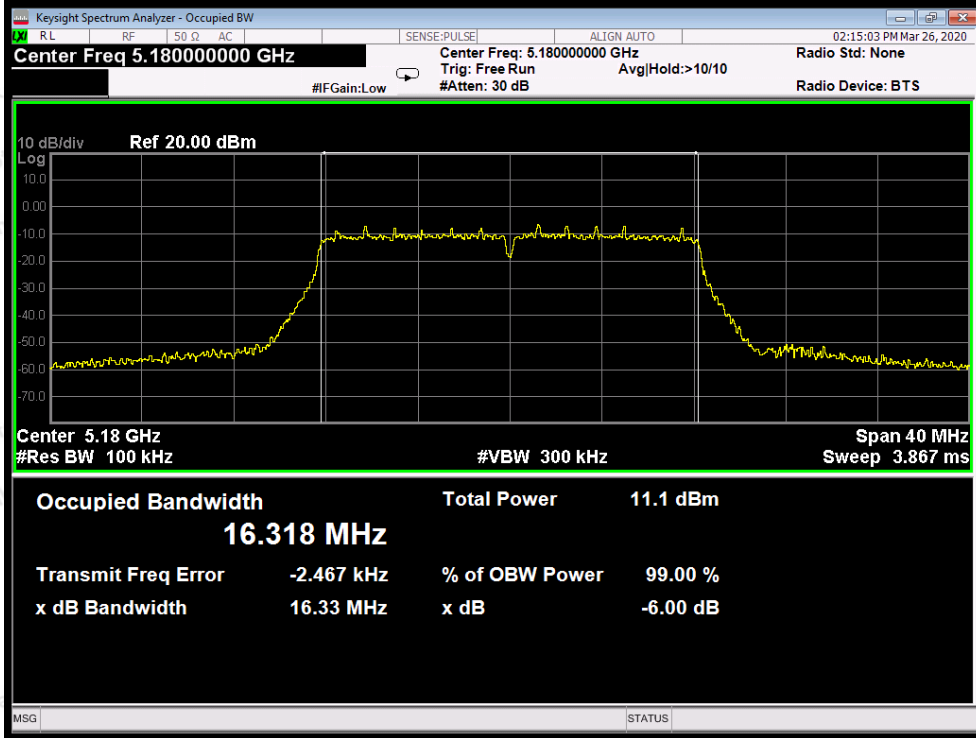

Test Mode: 802.11a--Low

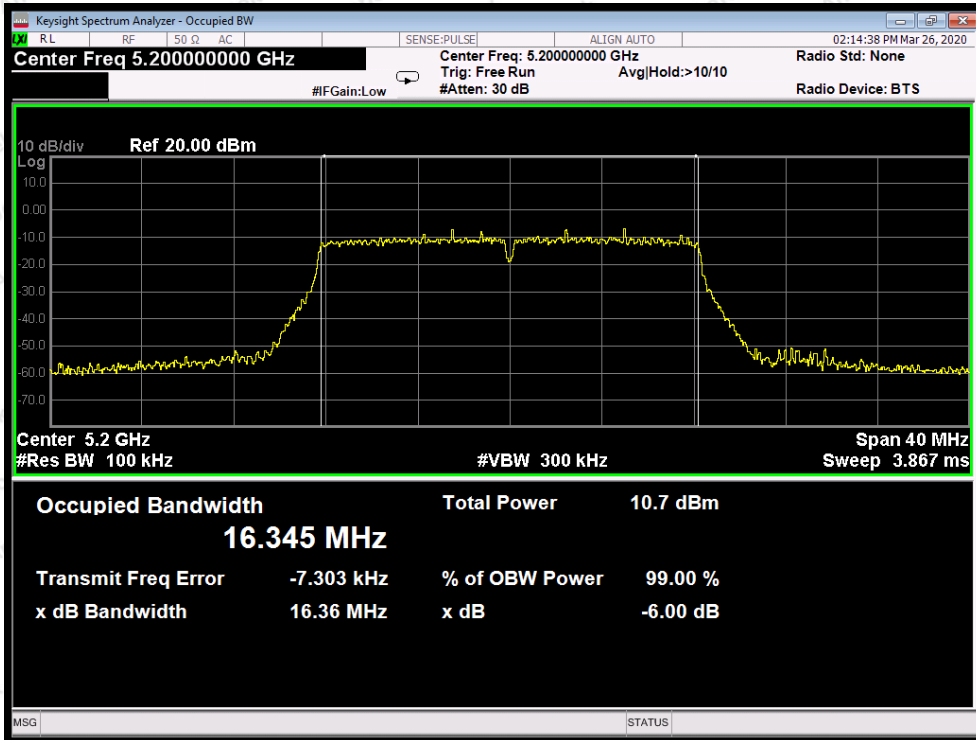

Test Mode: 802.11a--Middle

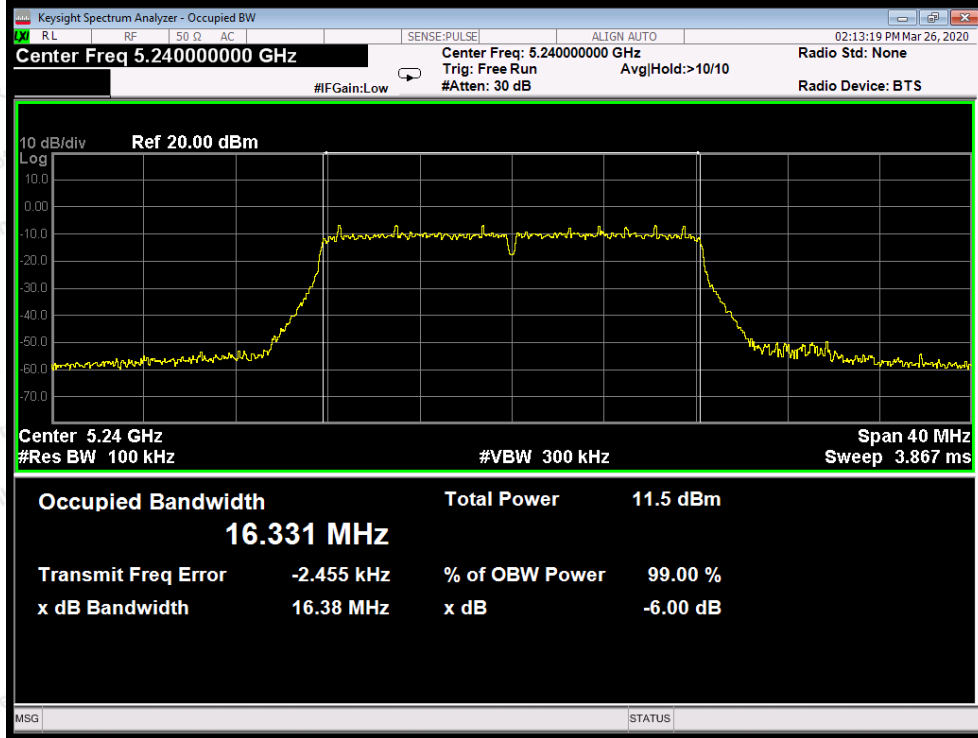

Test Mode: 802.11a---High

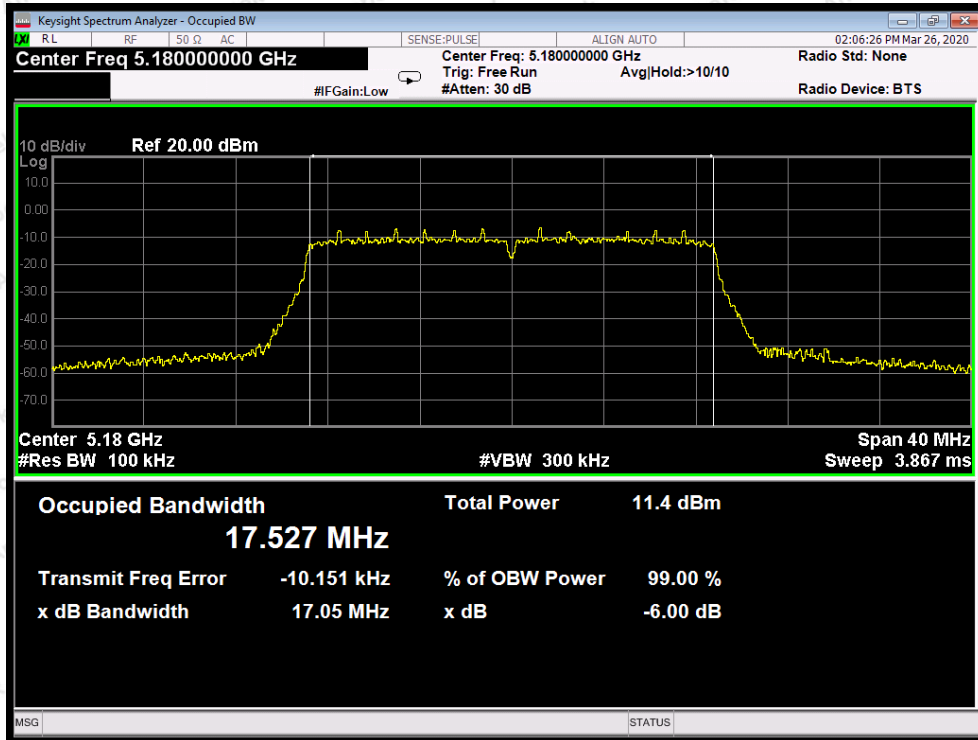

Test Mode: 802.11n20---Low

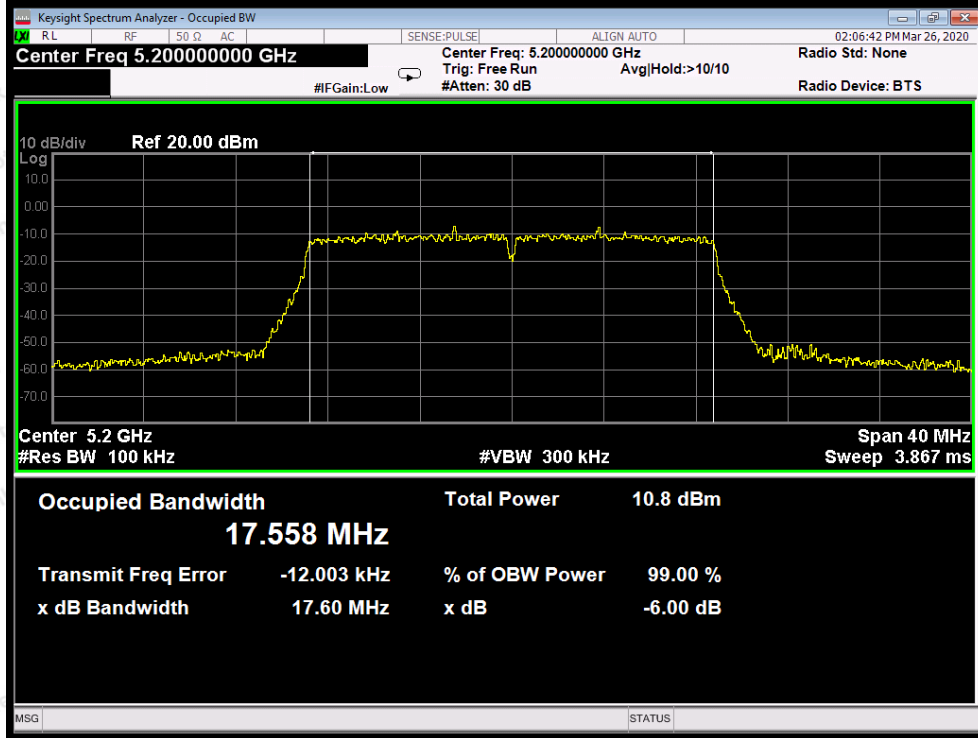

Test Mode: 802.11n20---Middle

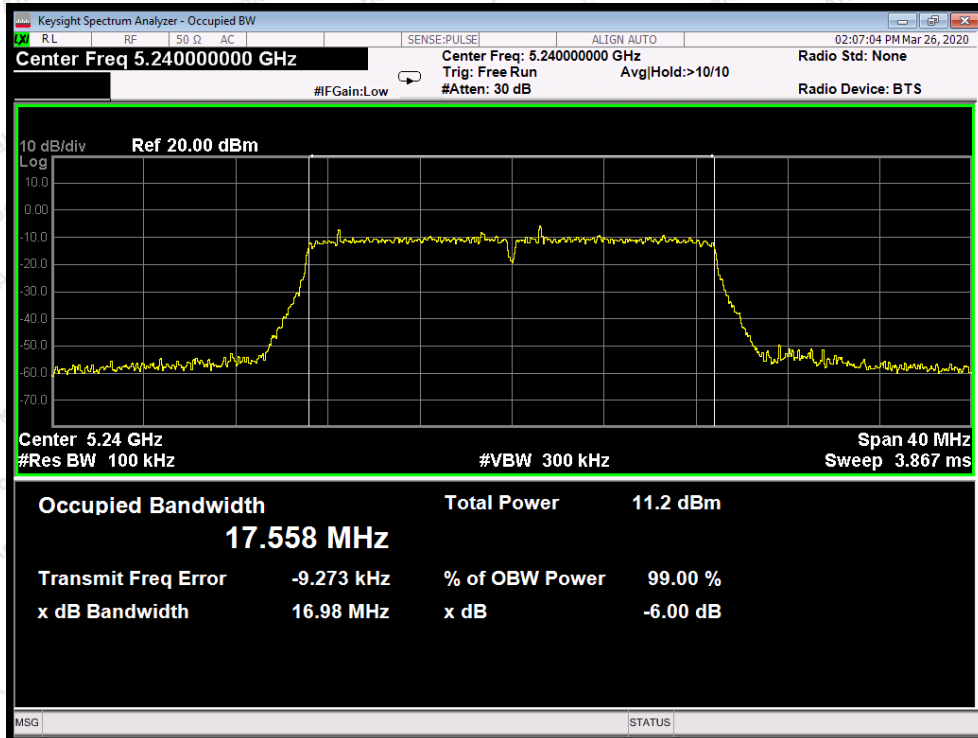

Test Mode: 802.11n20---High



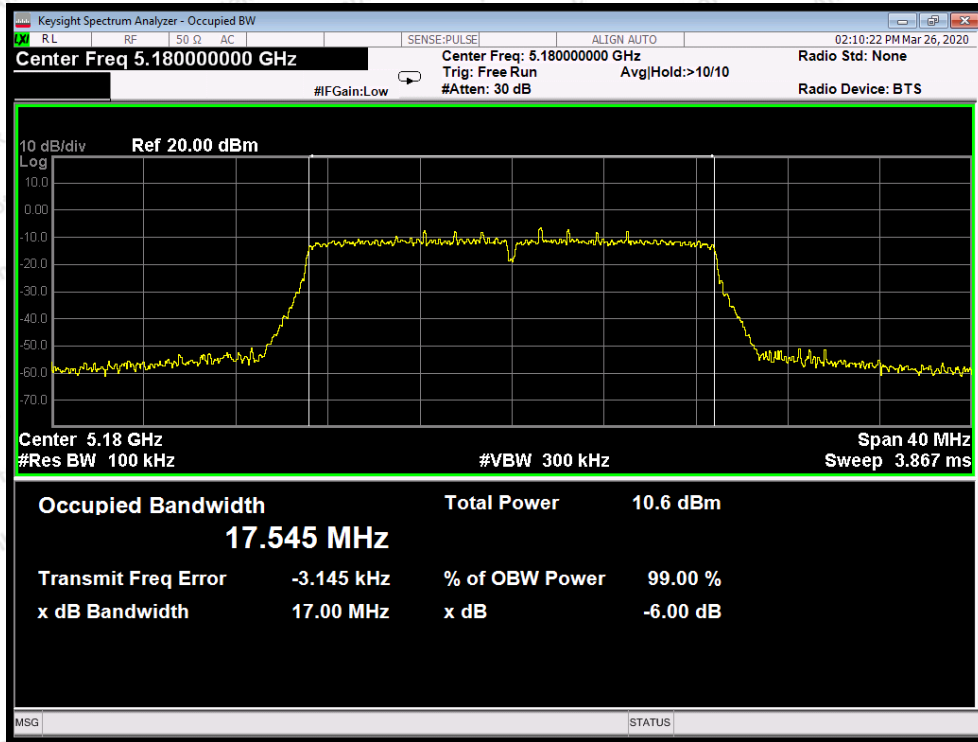

Test Mode: 802.11ac20--Low

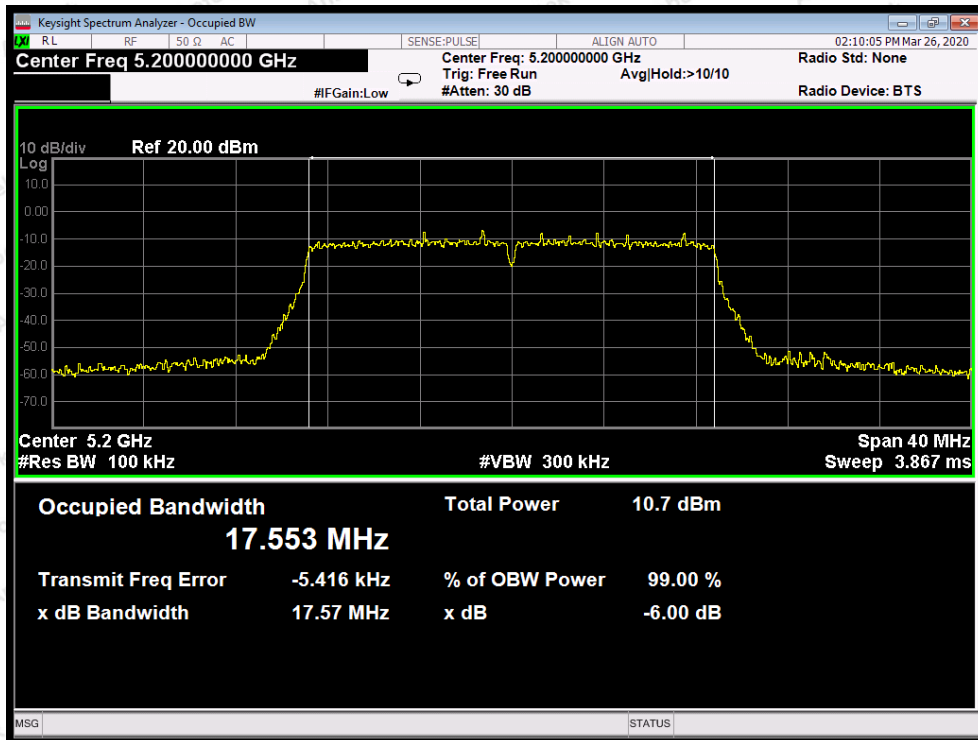

Test Mode: 802.11ac20---Middle

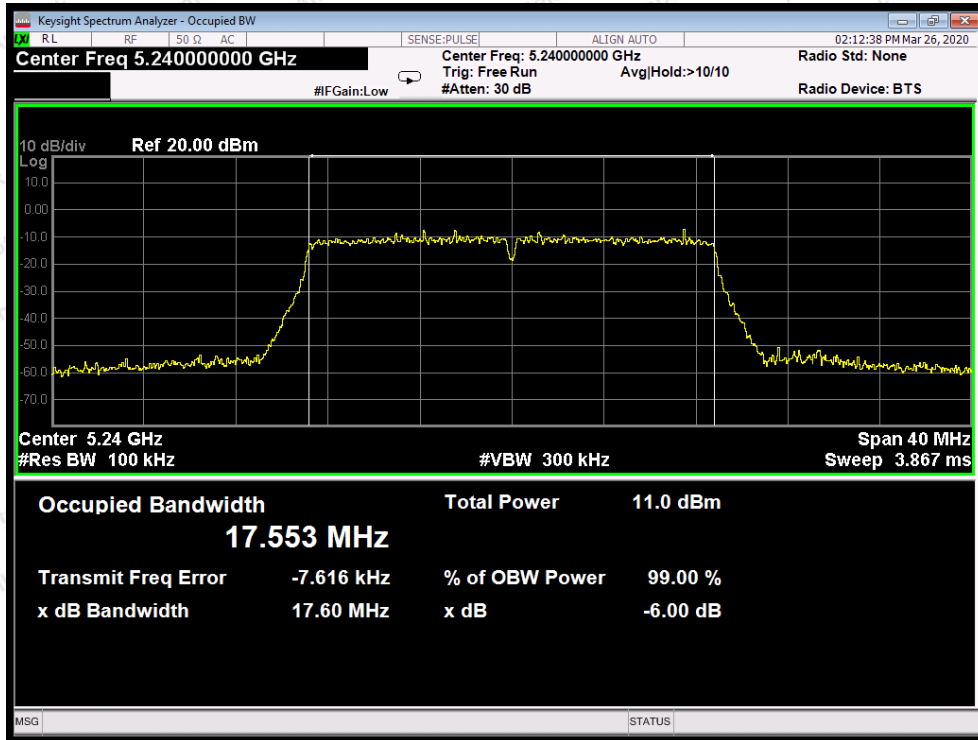

Test Mode: 802.11ac20---High

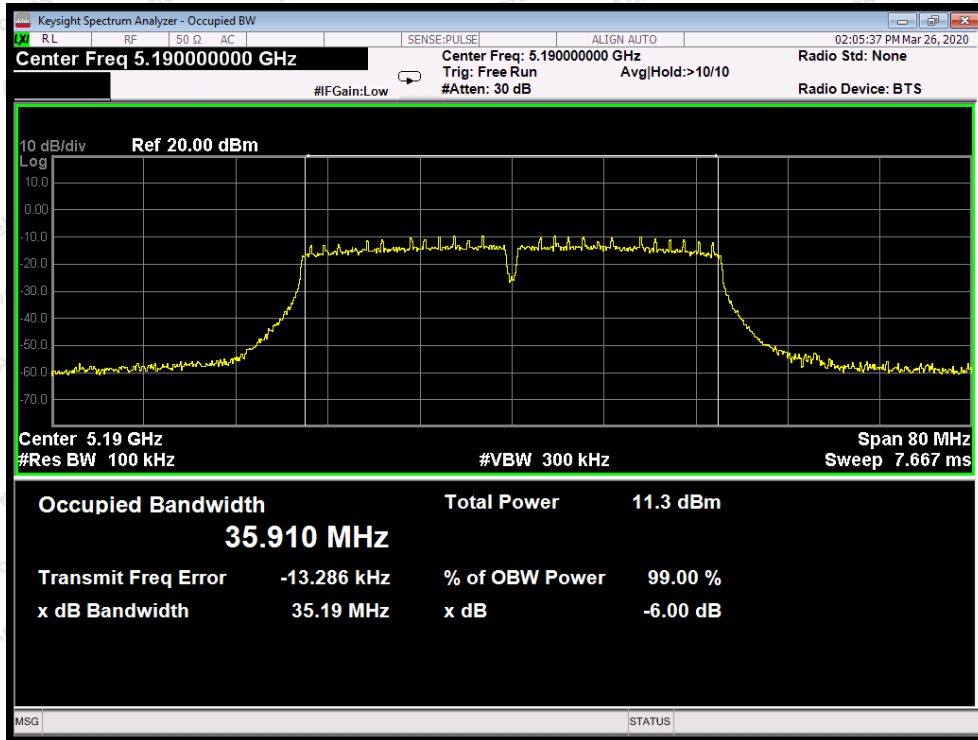

Test Mode: 802.11n40---Low

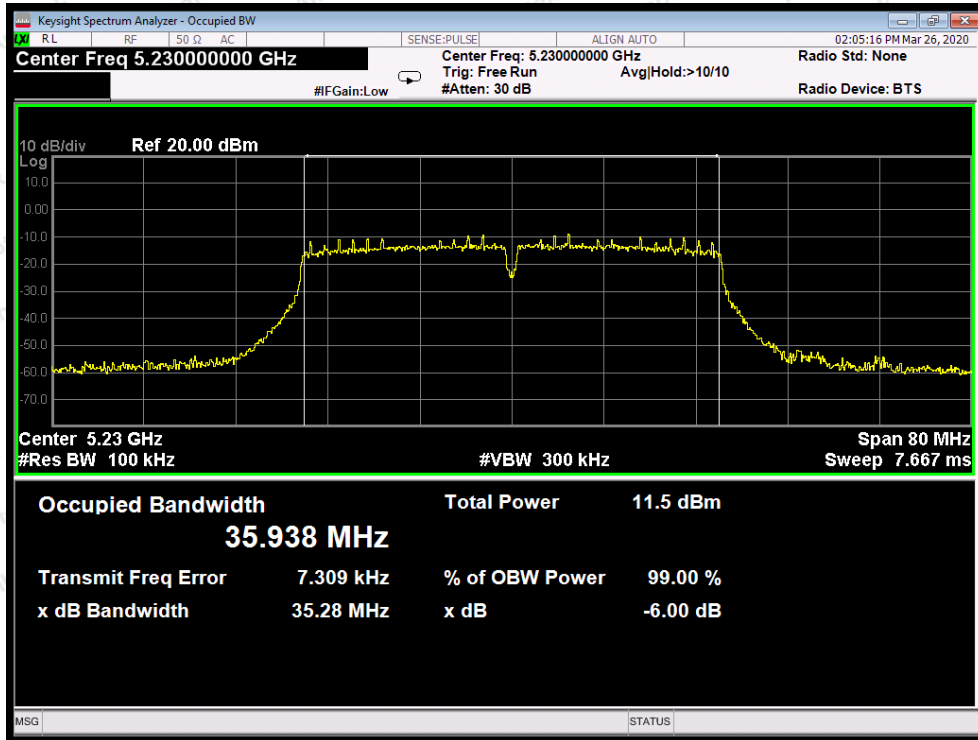

Test Mode: 802.11n40---High

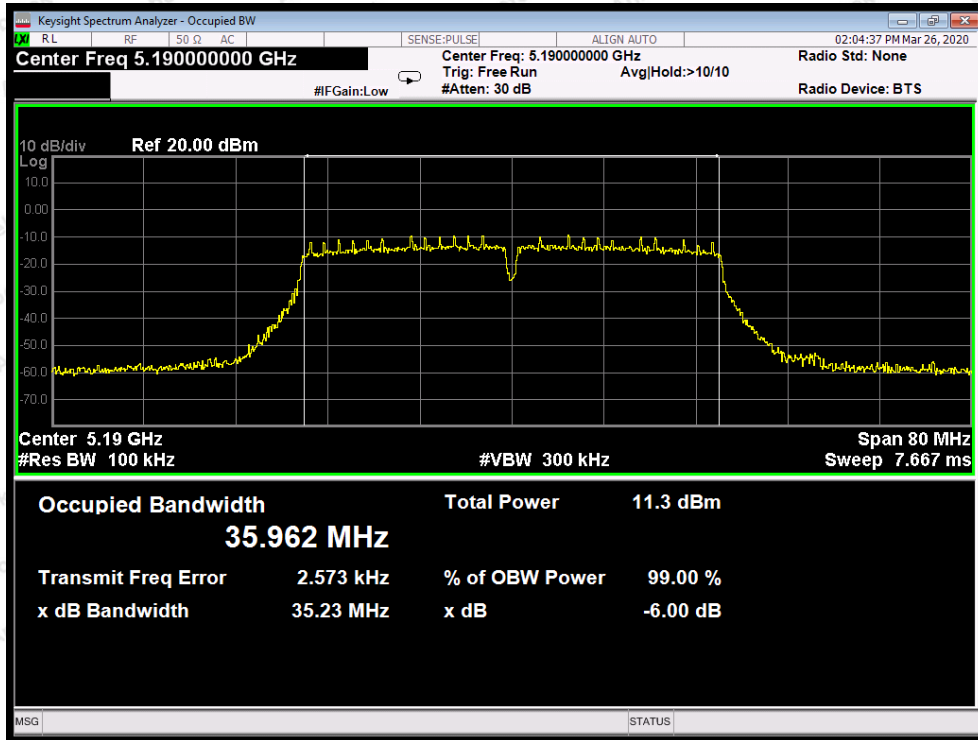

Test Mode: 802.11ac40---Low



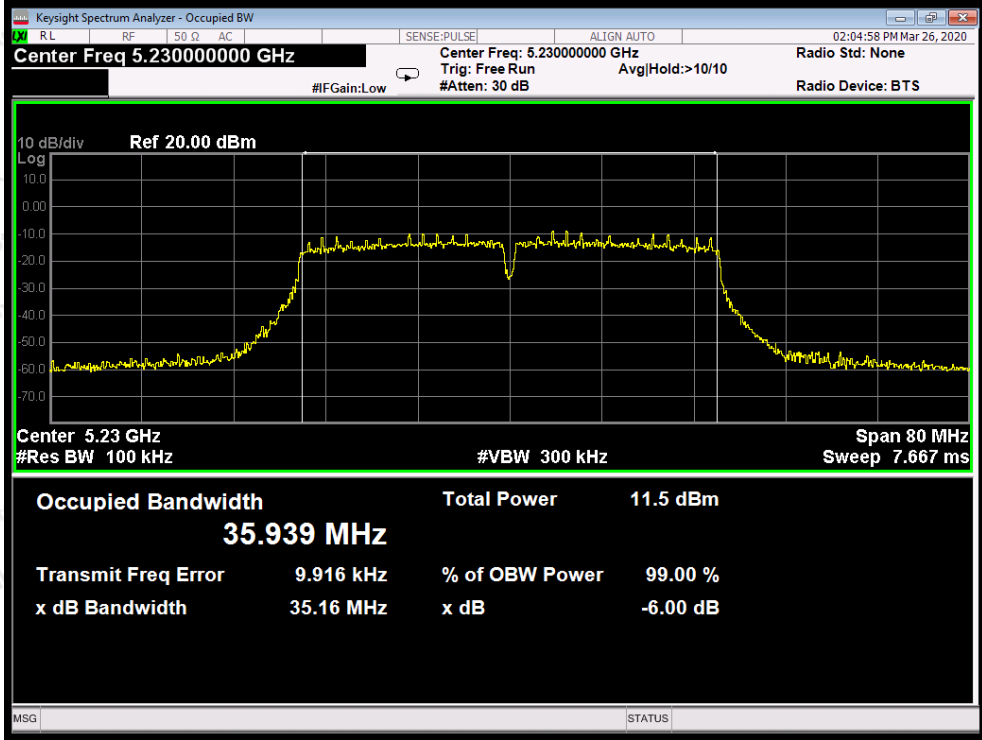

Test Mode: 802.11ac40---High

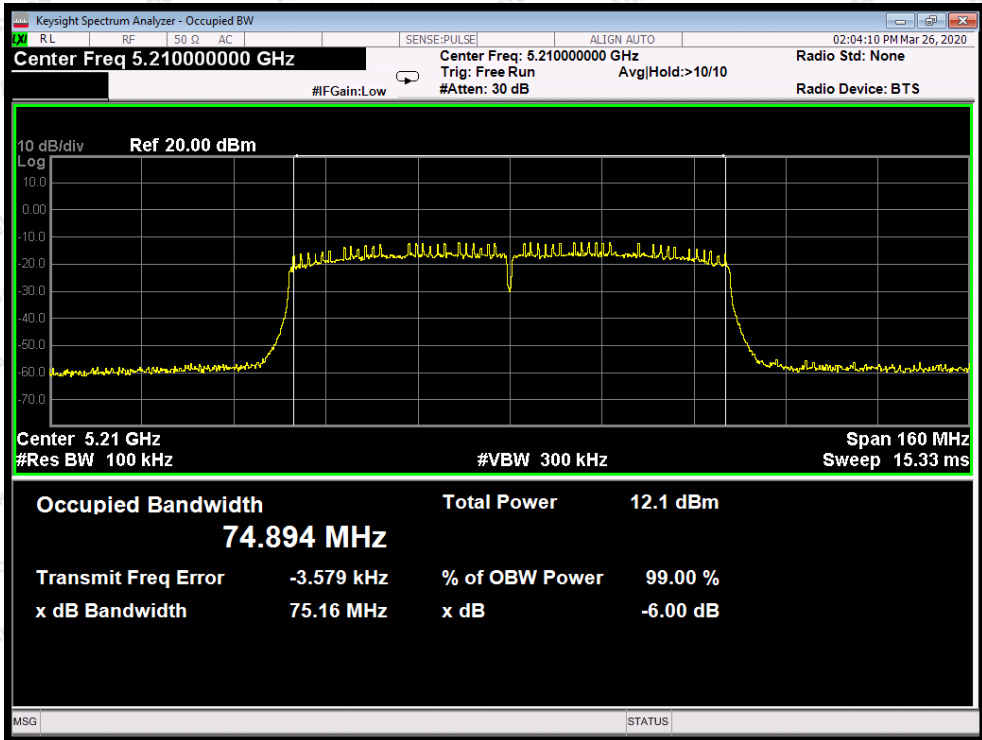

Test Mode: 802.11ac80

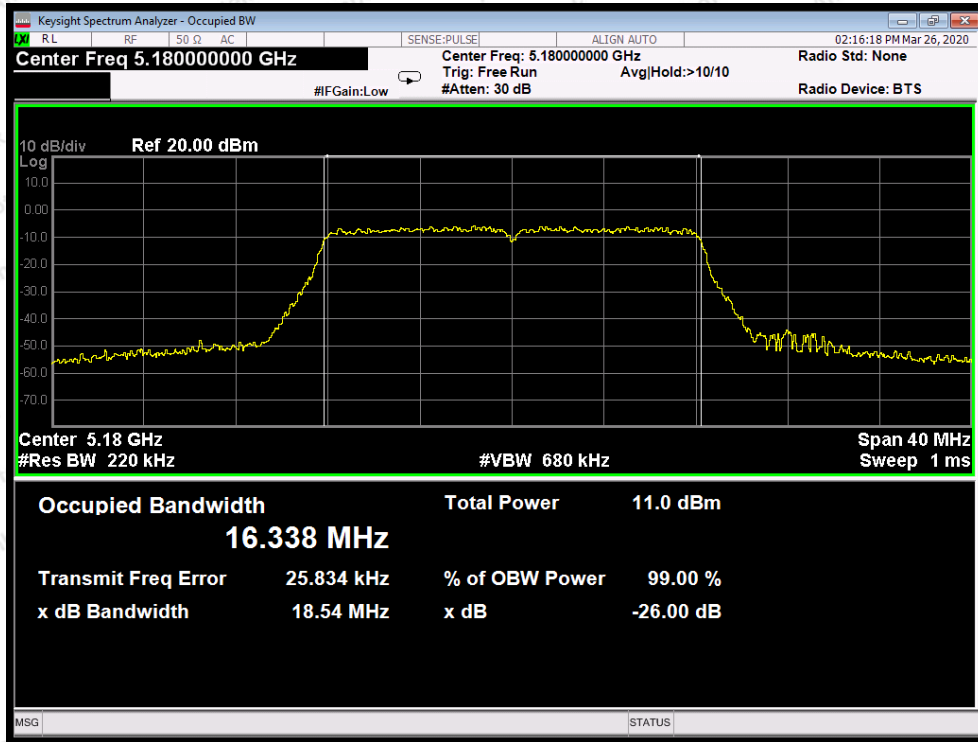

Test Mode: 802.11a--Low

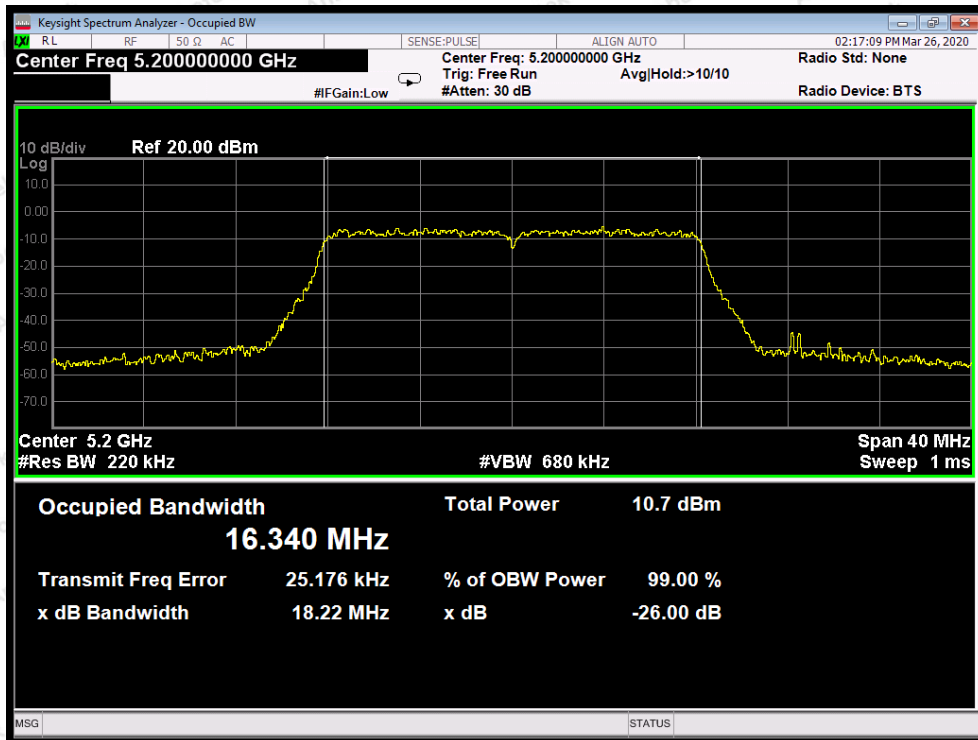

Test Mode: 802.11a--Middle

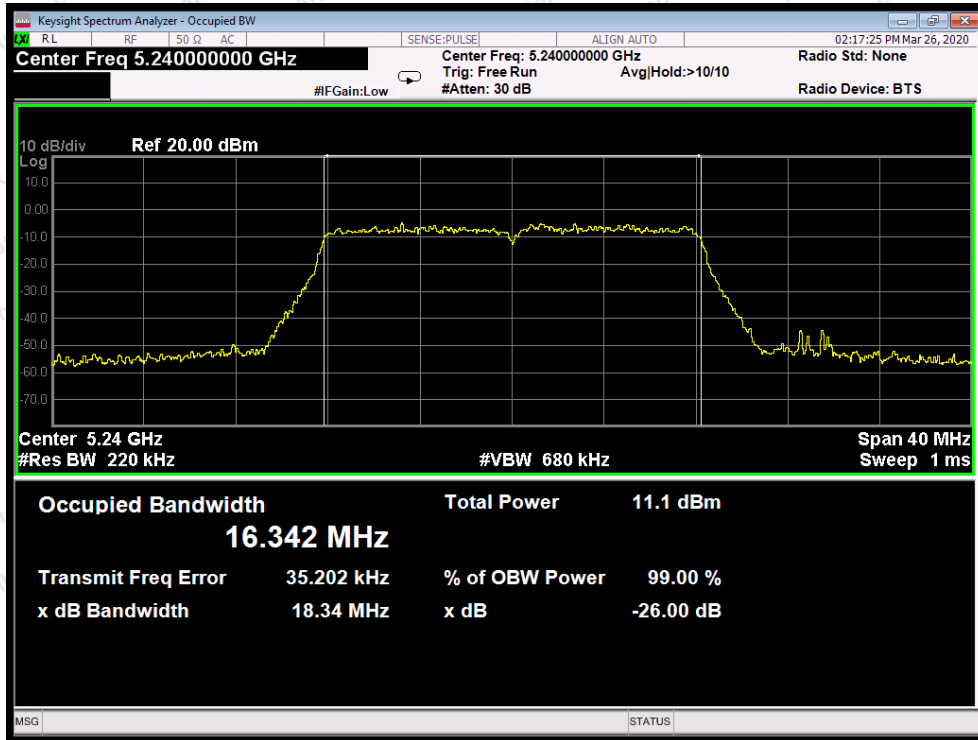

Test Mode: 802.11a---High

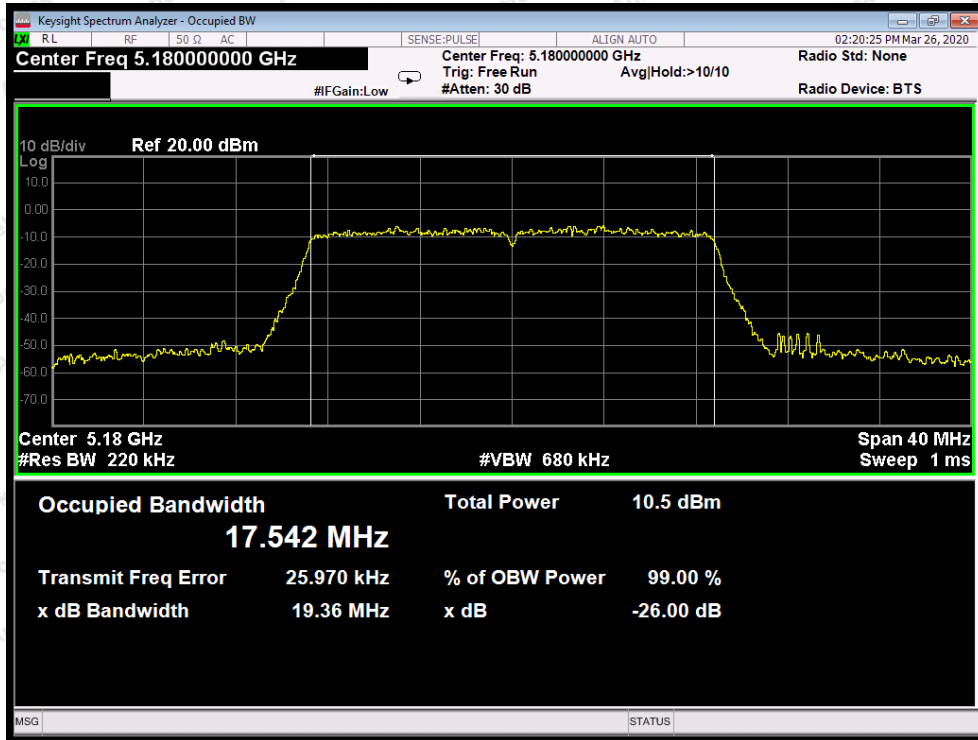

Test Mode: 802.11n20---Low



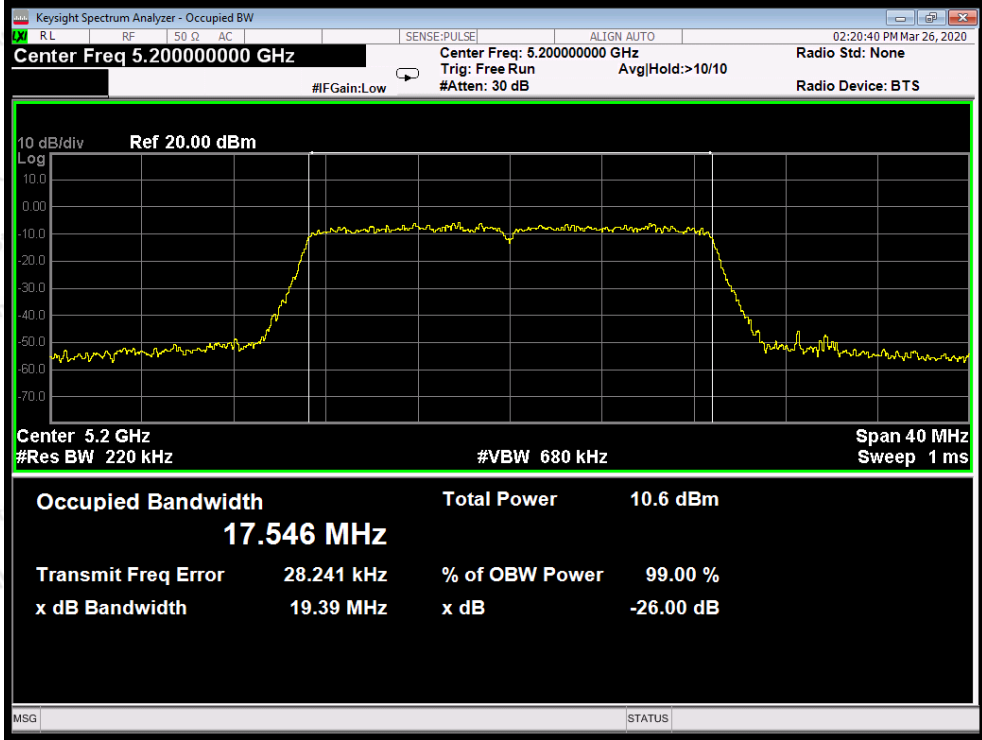

Test Mode: 802.11n20---Middle

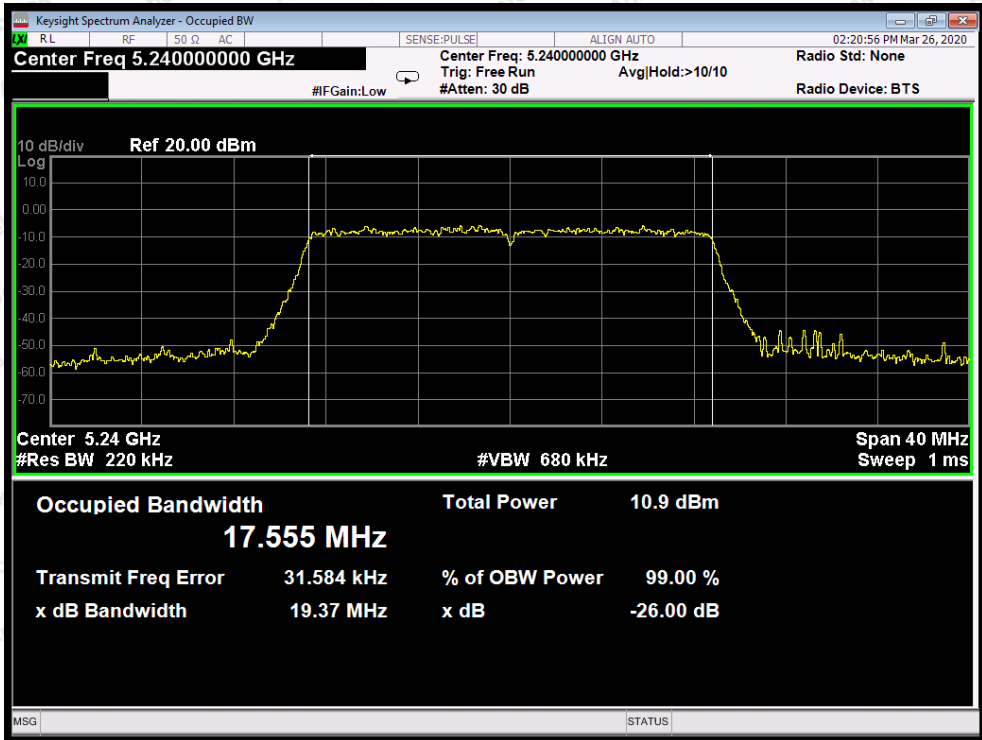

Test Mode: 802.11n20---High

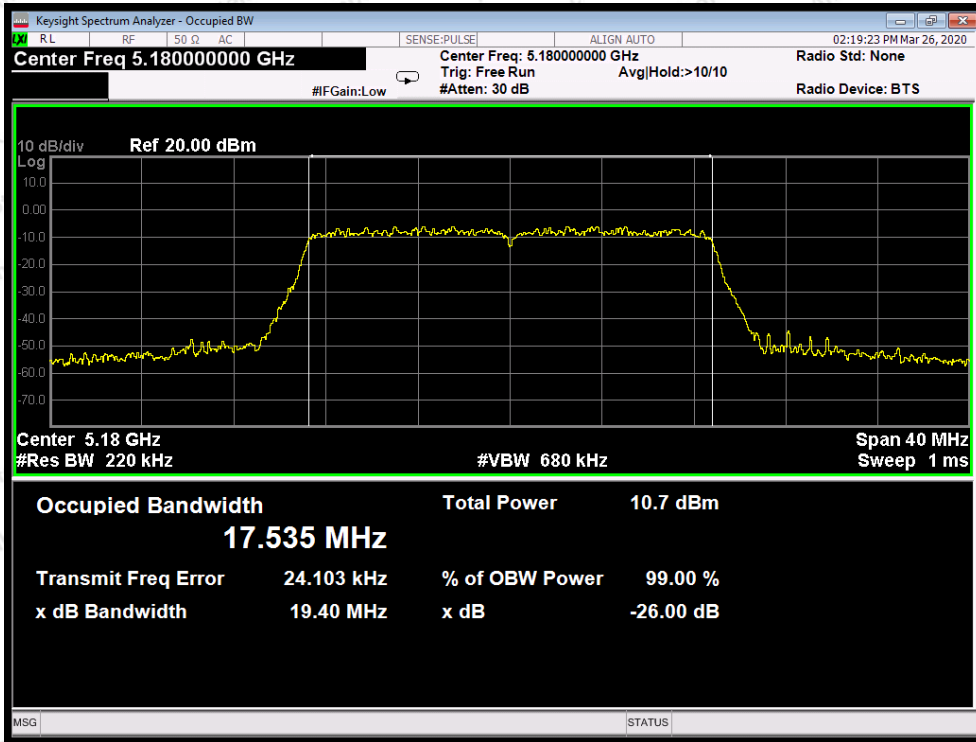

Test Mode: 802.11ac20--Low

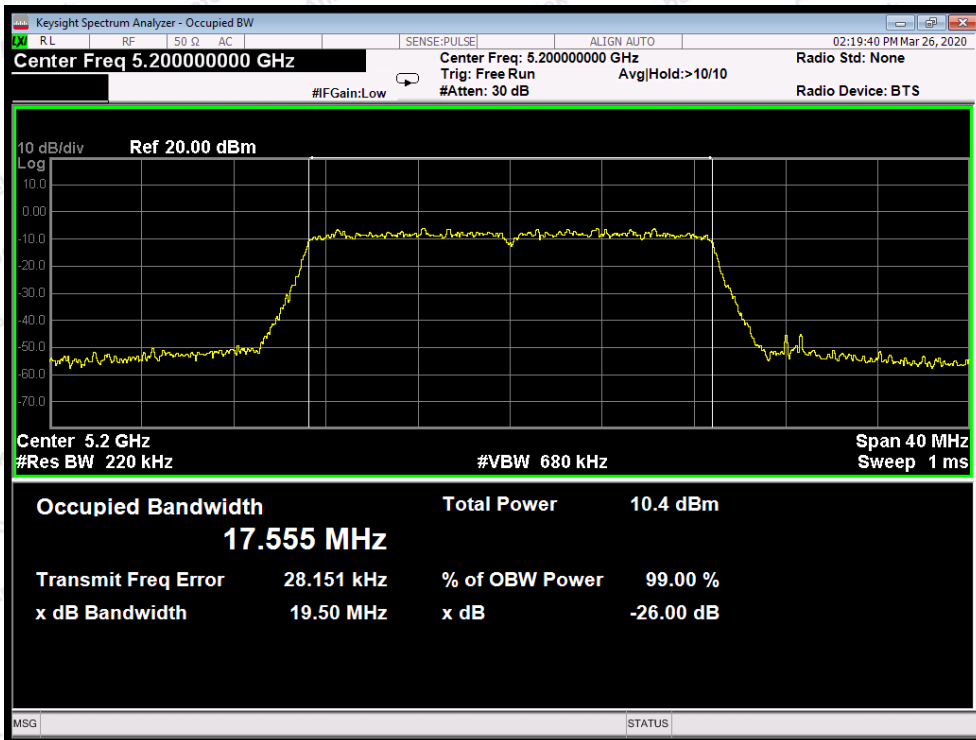

Test Mode: 802.11ac20---Middle

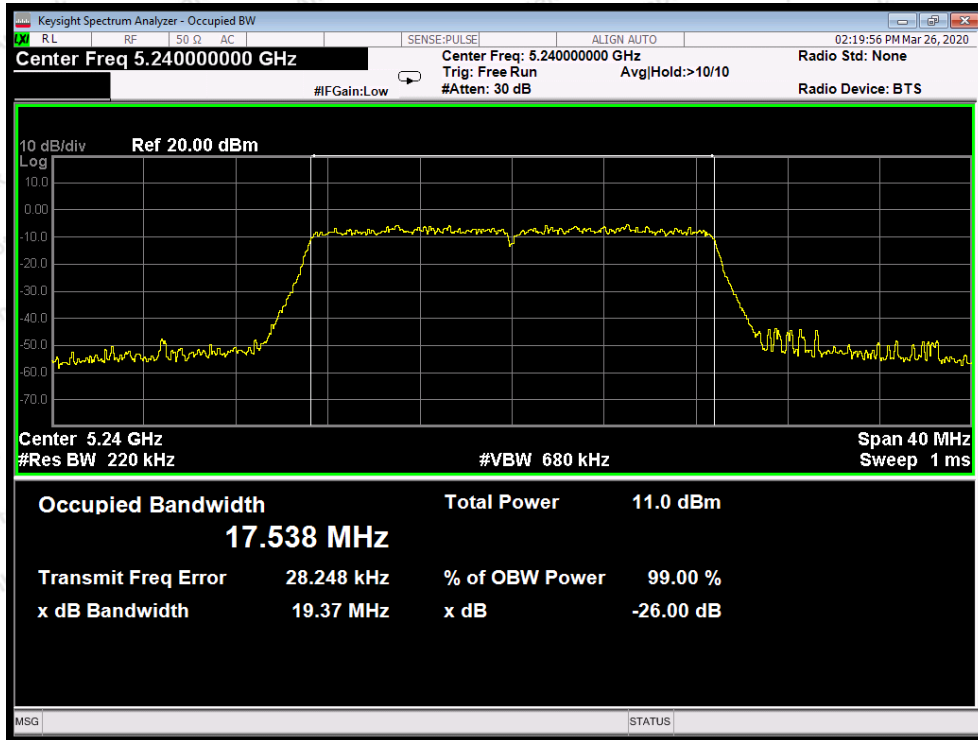

Test Mode: 802.11ac20---High

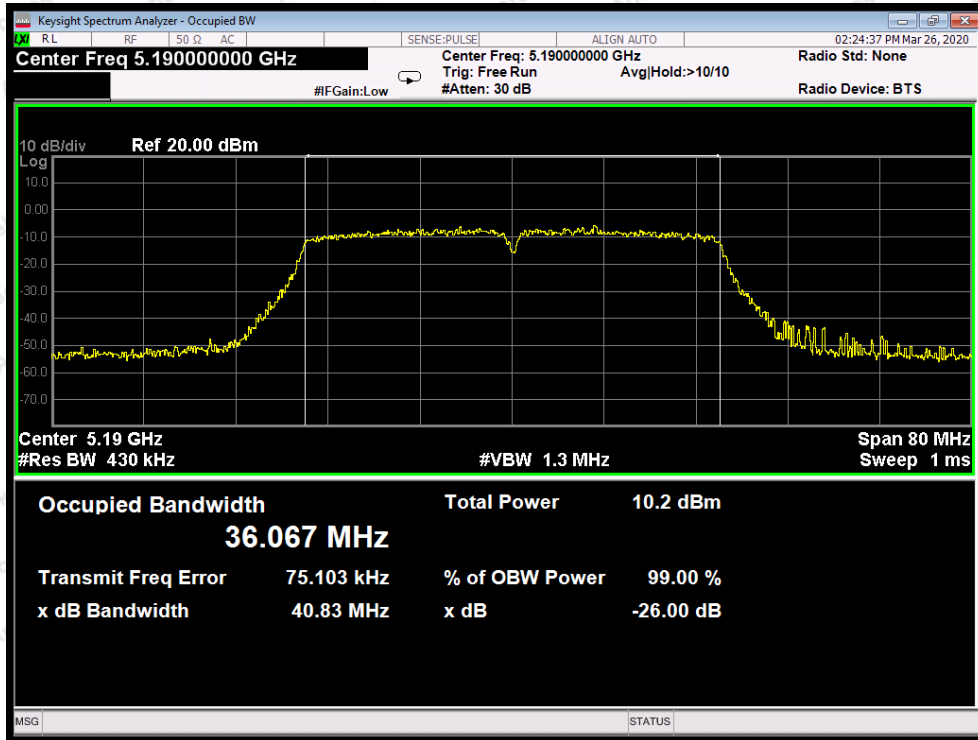

Test Mode: 802.11n40---Low



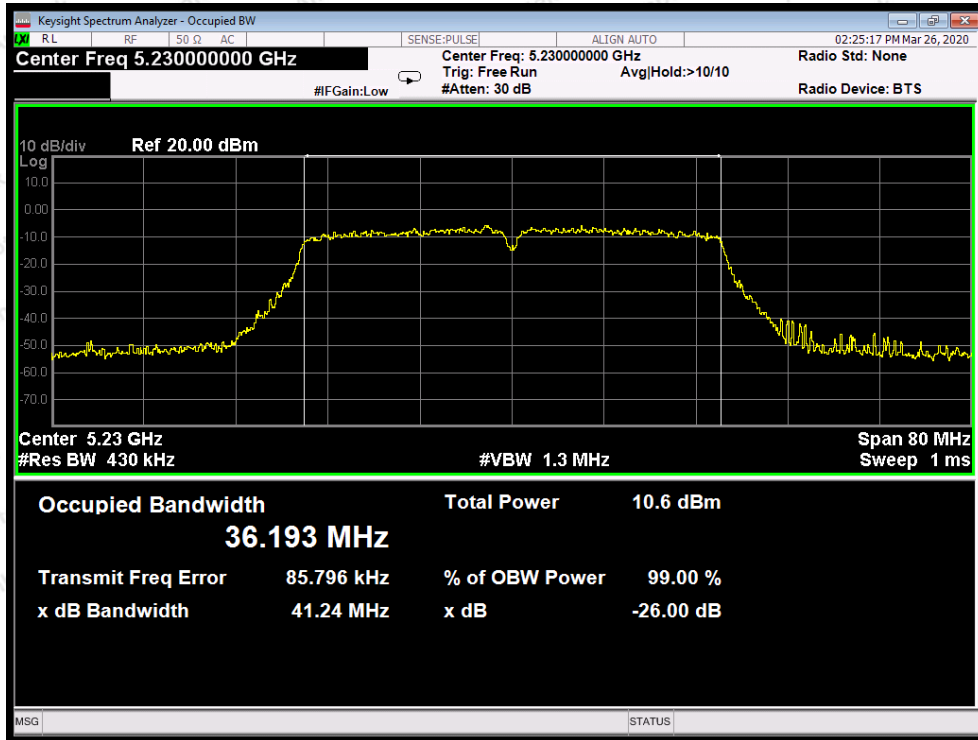

Test Mode: 802.11n40---High

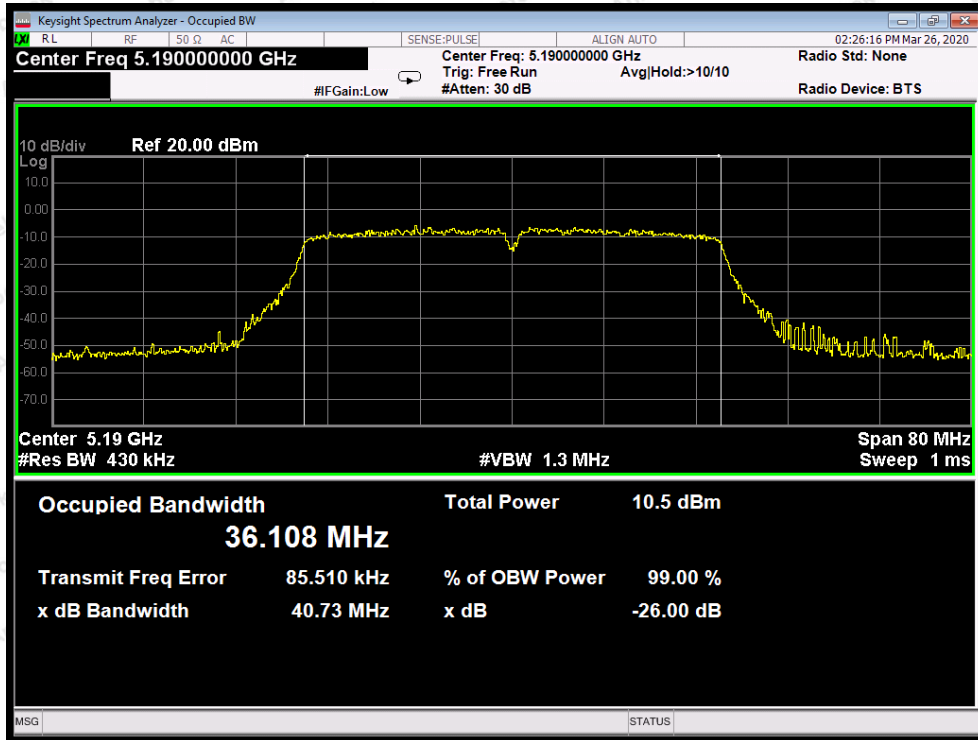

Test Mode: 802.11ac40---Low

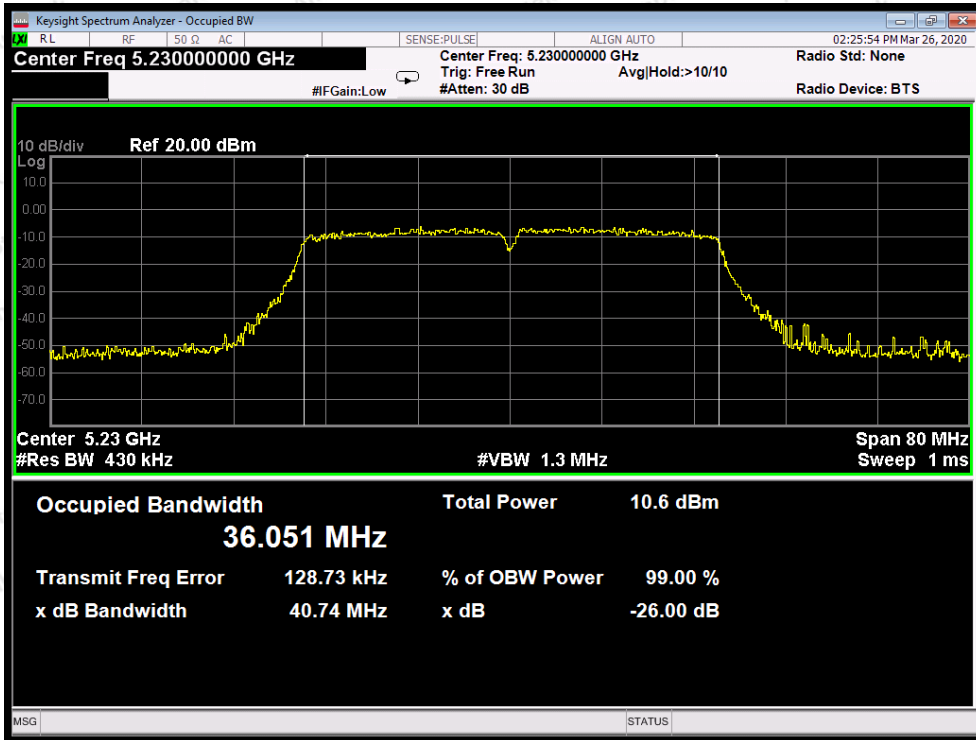

Test Mode: 802.11ac40---High

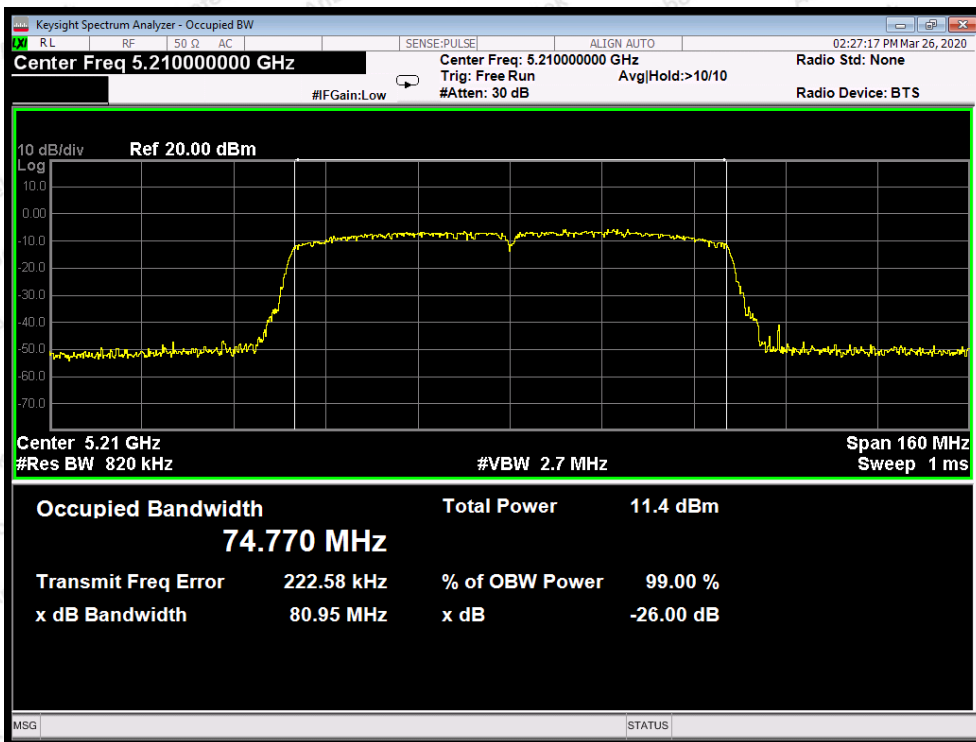

Test Mode: 802.11ac80

## 7. Power Spectral Density Test

### 7.1. Test Standard and Limit

Test Standard	FCC Part15 C Section 15.407 (a) (1) (iv)
Test Limit	11 dBm/MHz

### 7.2. Test Setup

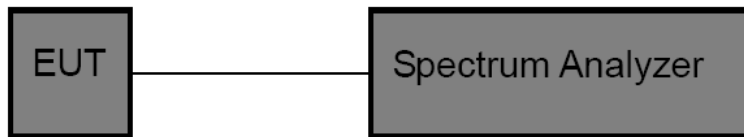

### 7.3. Test Procedure

For devices operating in the bands 5.15-5.25 GHz, 5.25-5.35 GHz, and 5.47-5.725 GHz, the above procedures make use of 1 MHz RBW to satisfy directly the 1 MHz reference bandwidth specified in § 15.407(a)(5). For devices operating in the band 5.725-5.85 GHz, the rules specify a measurement bandwidth of 500 kHz. Many spectrum analyzers do not have 500 kHz RBW, thus a narrower RBW may need to be used. The rules permit the use of a RBWs less than 1 MHz, or 500 kHz, “provided that the measured power is integrated over the full reference bandwidth” to show the total power over the specified measurement bandwidth (i.e., 1 MHz, or 500 kHz).

1. The EUT is directly connected to the spectrum analyzer;
2. Set RBW =1MHz;
3. Set VBW  $\geq$  3 RBW=3MHz;
3. Set the span to encompass the entire emissions bandwidth (EBW) of the signal;
5. Detector=RMS;
6. Sweep time= auto couple;
7. Trace mode=max. hold;

### 7.4. Test Data



Test Item : Power Spectral Density  
 Test Voltage : AC 120V, 60Hz for adapter  
 Test Result : PASS

Test Mode : CH Low ~ CH High  
 Temperature : 24°C  
 Humidity : 55%RH

ANT A

Test Mode	Channel Frequency (MHz)	Final Power Spectral Density (dBm/MHz)	Correctional Limit (dBm/MHz)	Results
802.11a	5180	0.786	11	PASS
	5200	0.842	11	PASS
	5240	1.437	11	PASS
802.11n20	5180	0.961	11	PASS
	5200	0.647	11	PASS
	5240	1.423	11	PASS
802.11ac20	5180	0.786	11	PASS
	5200	0.931	11	PASS
	5240	2.001	11	PASS
802.11n40	5190	-2.420	11	PASS
	5230	-1.926	11	PASS
802.11ac40	5190	-2.155	11	PASS
	5230	-1.411	11	PASS
802.11ac80	5210	-4.990	11	PASS

ANT B

Test Mode	Channel Frequency (MHz)	Final Power Spectral Density (dBm/MHz)	Correctional Limit (dBm/MHz)	Results
802.11a	5180	1.729	11	PASS
	5200	0.909	11	PASS
	5240	1.389	11	PASS
802.11n20	5180	0.584	11	PASS
	5200	1.302	11	PASS
	5240	1.716	11	PASS
802.11ac20	5180	0.589	11	PASS
	5200	0.654	11	PASS
	5240	1.532	11	PASS
802.11n40	5190	-1.157	11	PASS
	5230	-1.910	11	PASS
802.11ac40	5190	-2.303	11	PASS
	5230	-1.924	11	PASS
802.11ac80	5210	-5.229	11	PASS

ANT A+ANT B

Test Mode	Channel Frequency (MHz)	Final Power Spectral Density (dBm/MHz)	Correctional Limit (dBm/MHz)	Results
802.11n20	5180	3.787	11	PASS
	5200	3.997	11	PASS
	5240	4.582	11	PASS
802.11ac20	5180	3.699	11	PASS
	5200	3.805	11	PASS
	5240	4.783	11	PASS
802.11n40	5190	1.268	11	PASS
	5230	1.092	11	PASS
802.11ac40	5190	0.782	11	PASS
	5230	1.350	11	PASS
802.11ac80	5210	-2.098	11	PASS



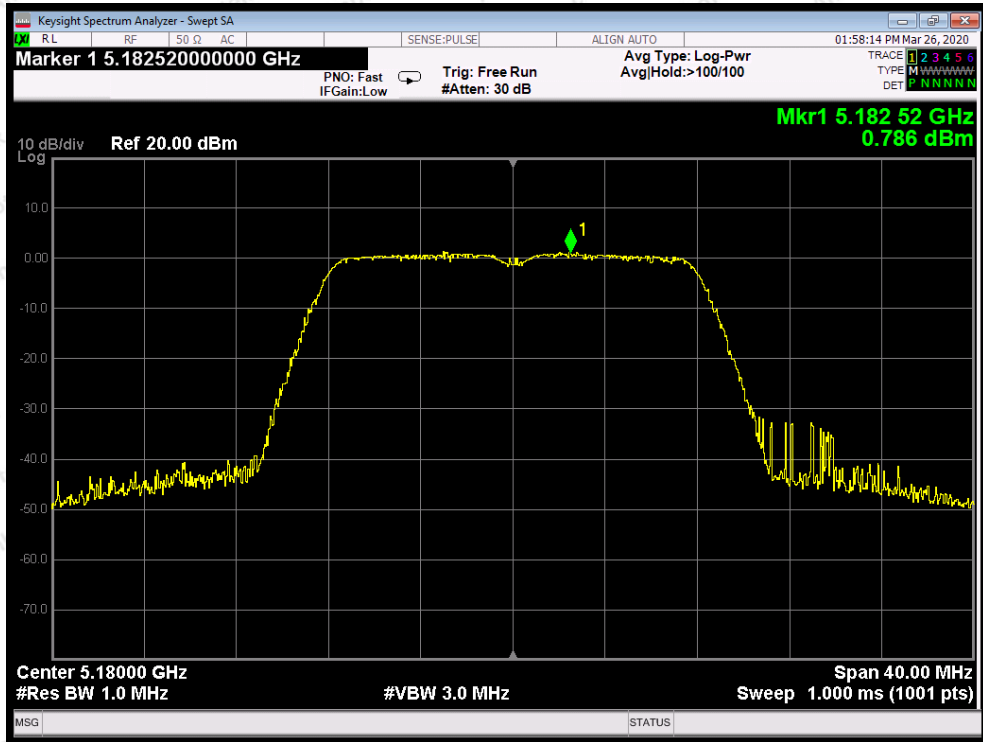

Test Mode: 802.11a--Low

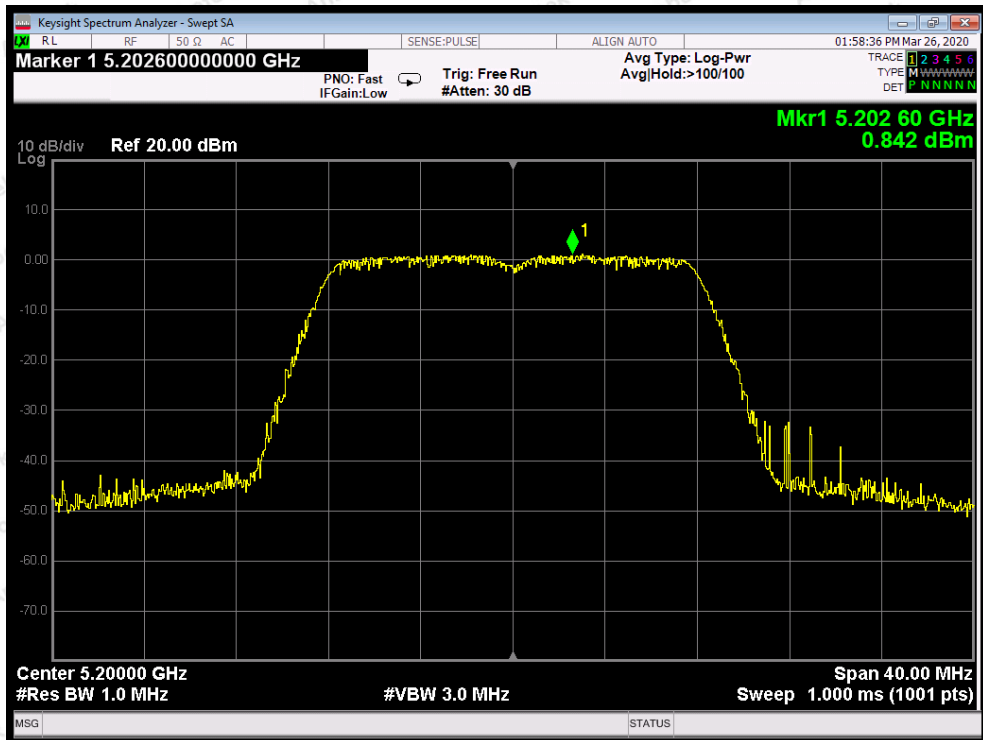

Test Mode: 802.11a--Middle

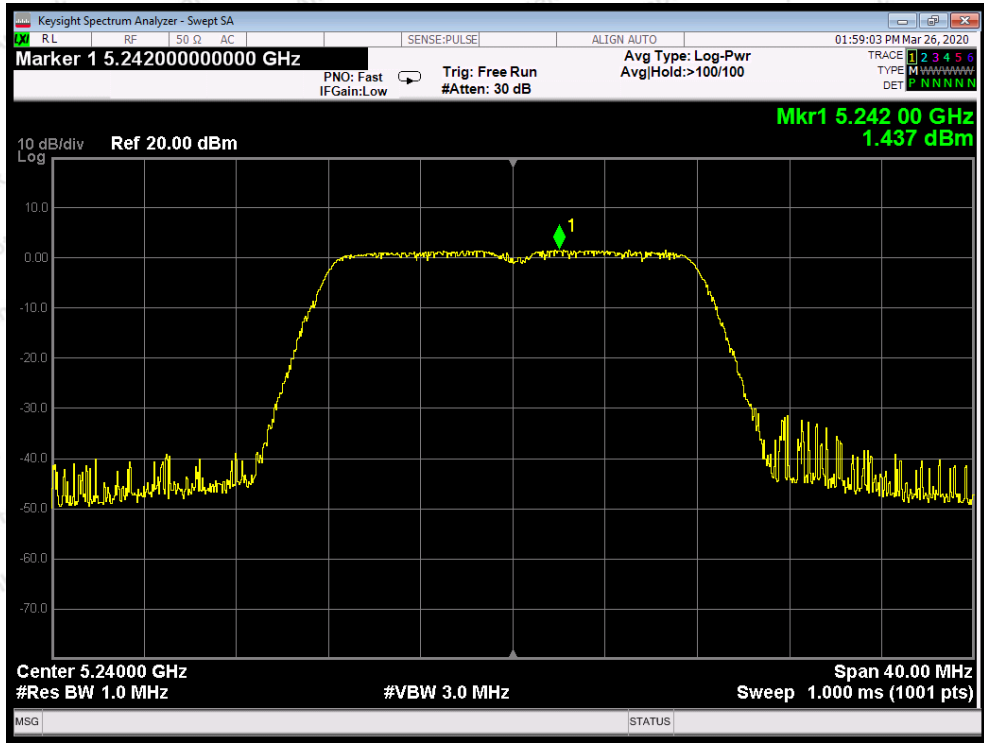

Test Mode: 802.11a---High

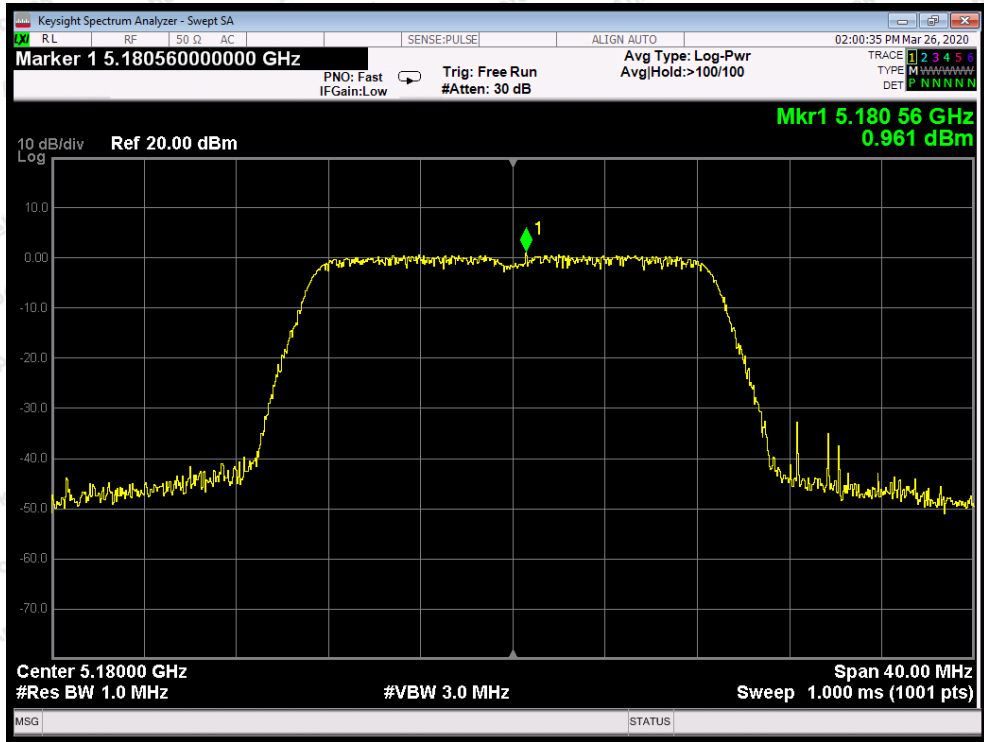

Test Mode: 802.11n20---Low

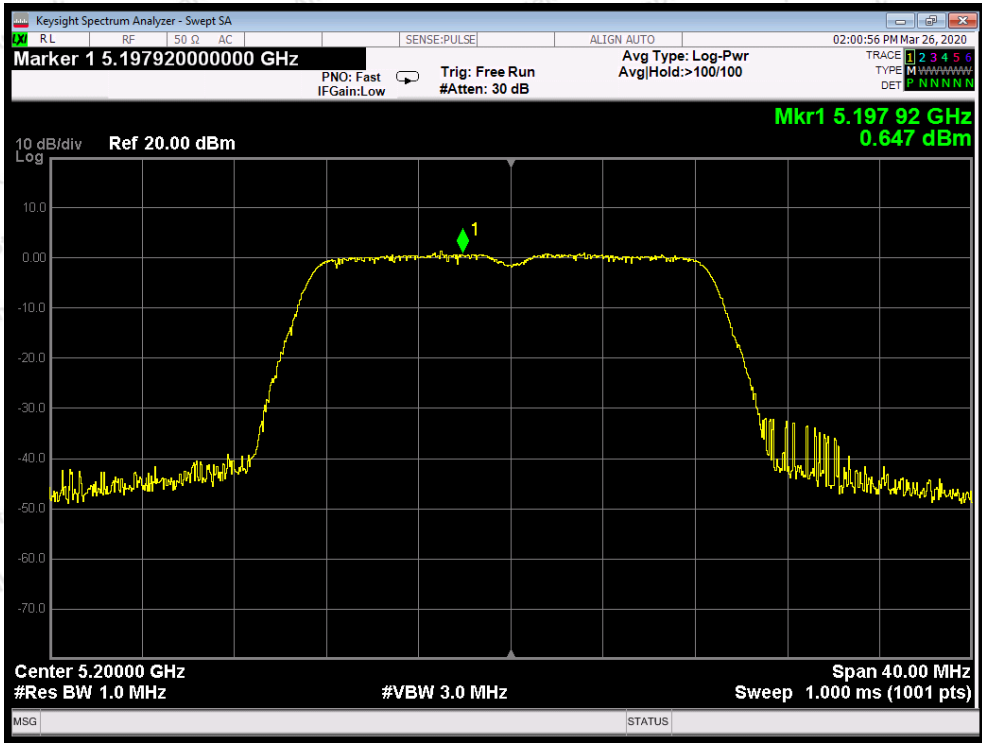

Test Mode: 802.11n20---Middle

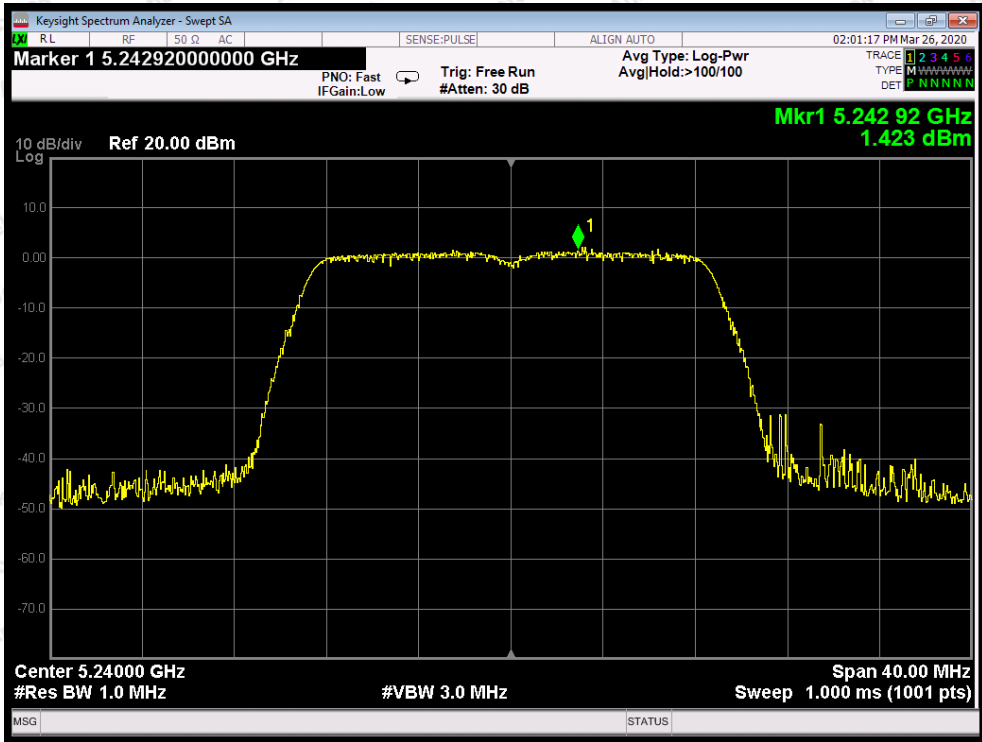

Test Mode: 802.11n20---High



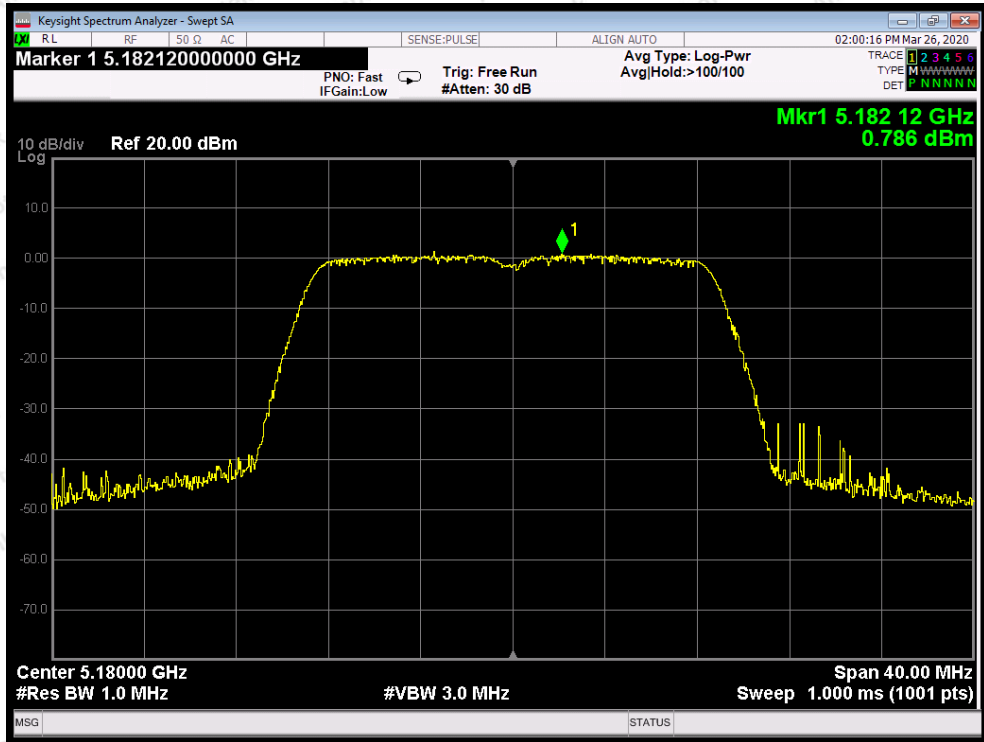

Test Mode: 802.11ac20--Low

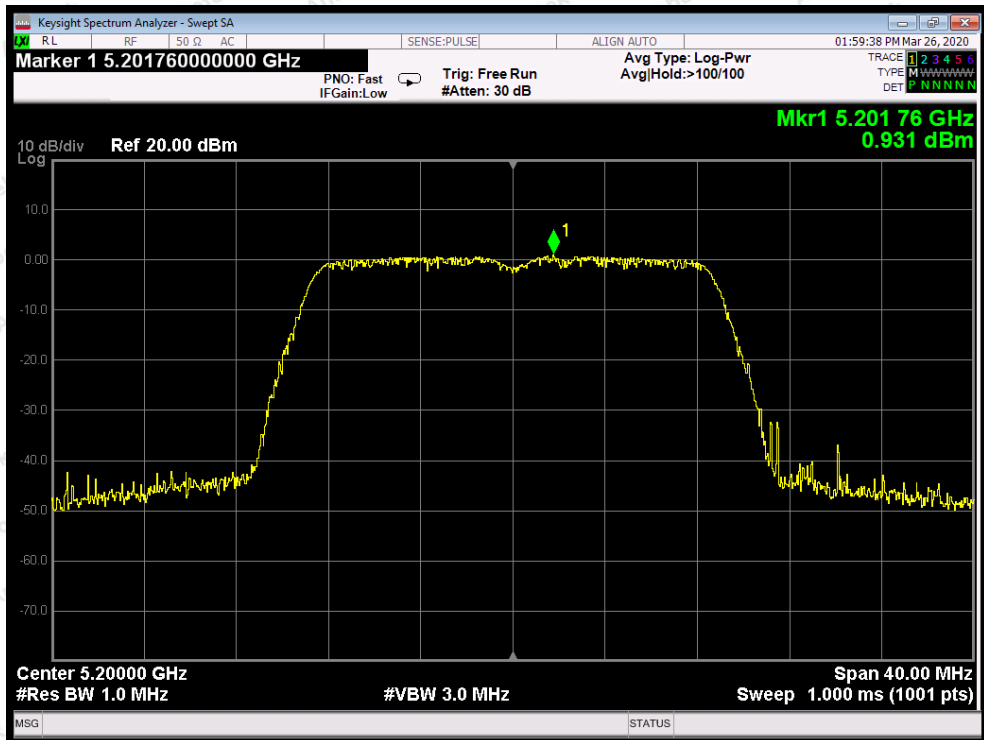

Test Mode: 802.11ac20---Middle

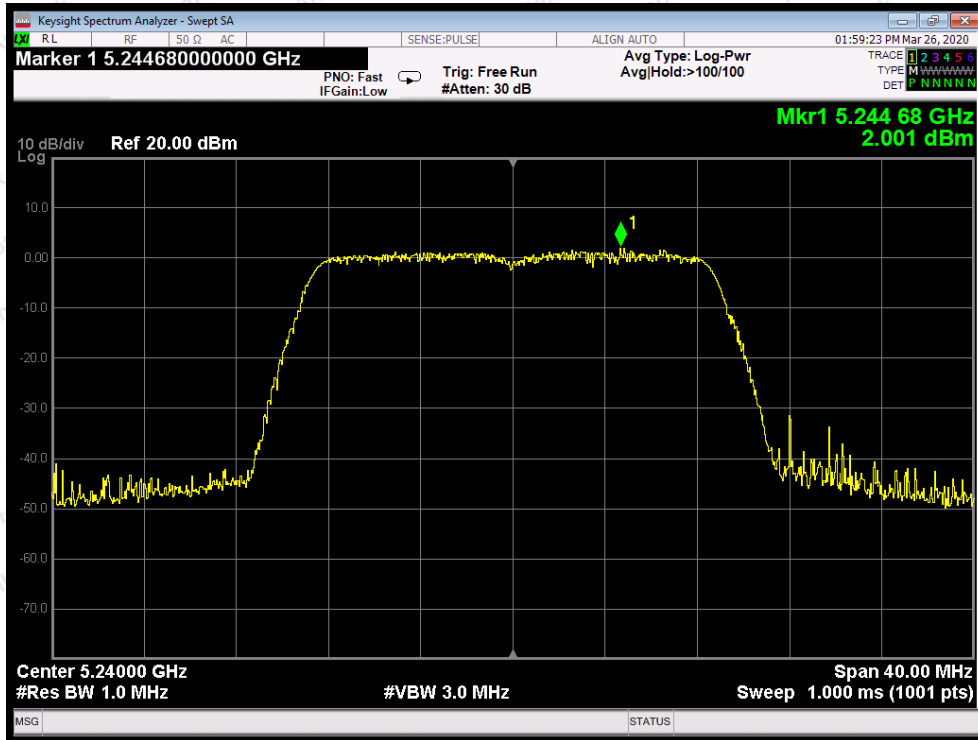

Test Mode: 802.11ac20---High

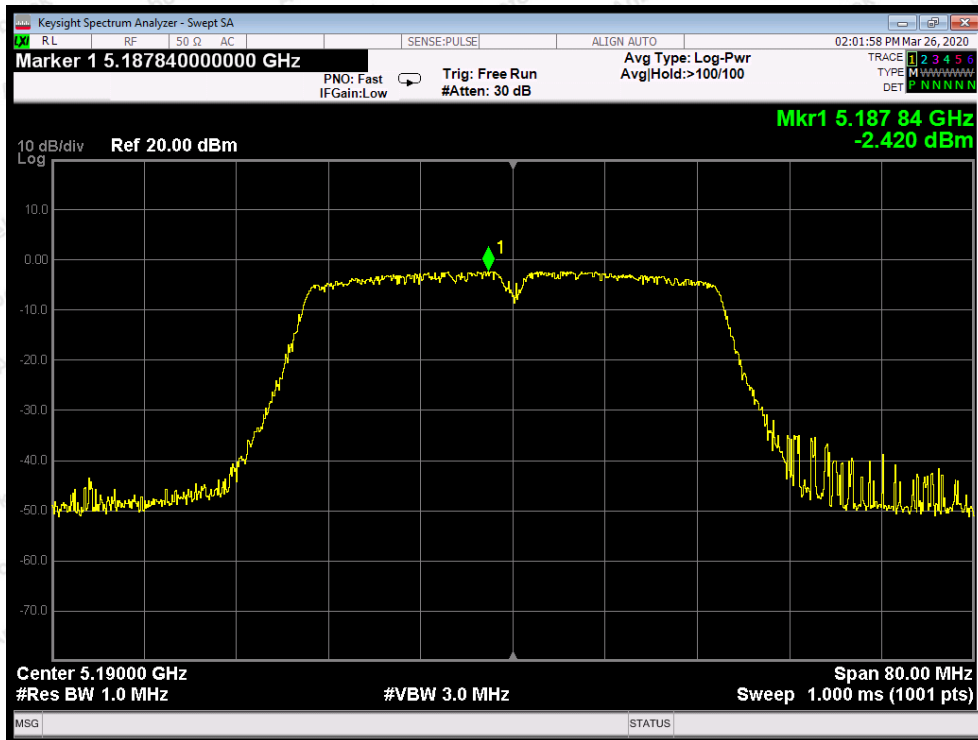

Test Mode: 802.11n40---Low

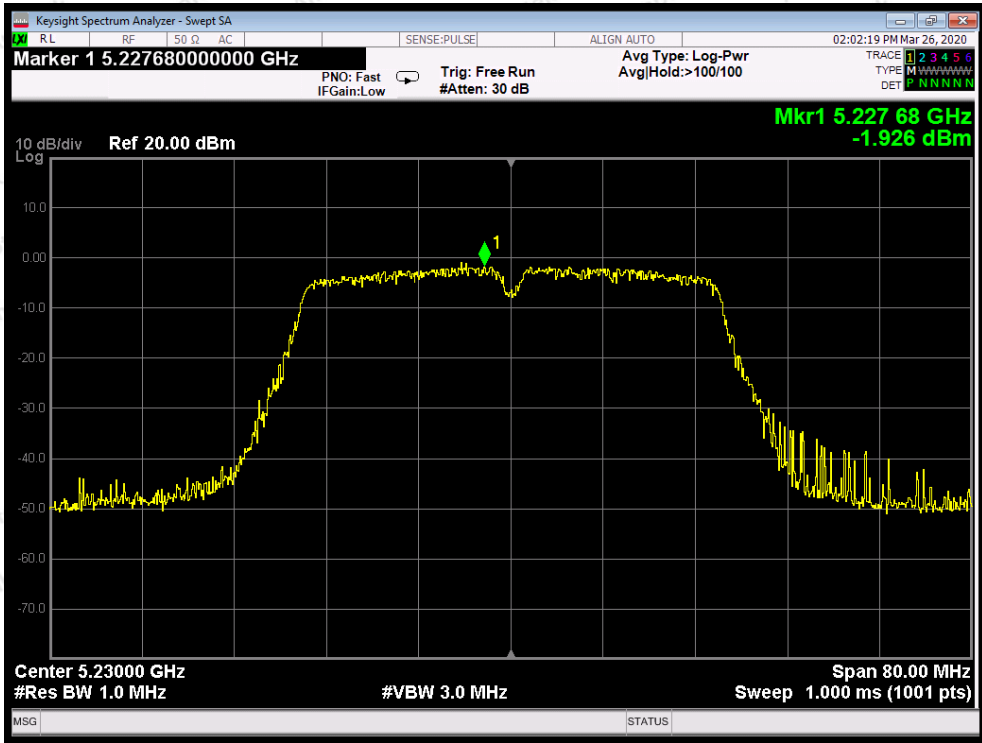

Test Mode: 802.11n40---High

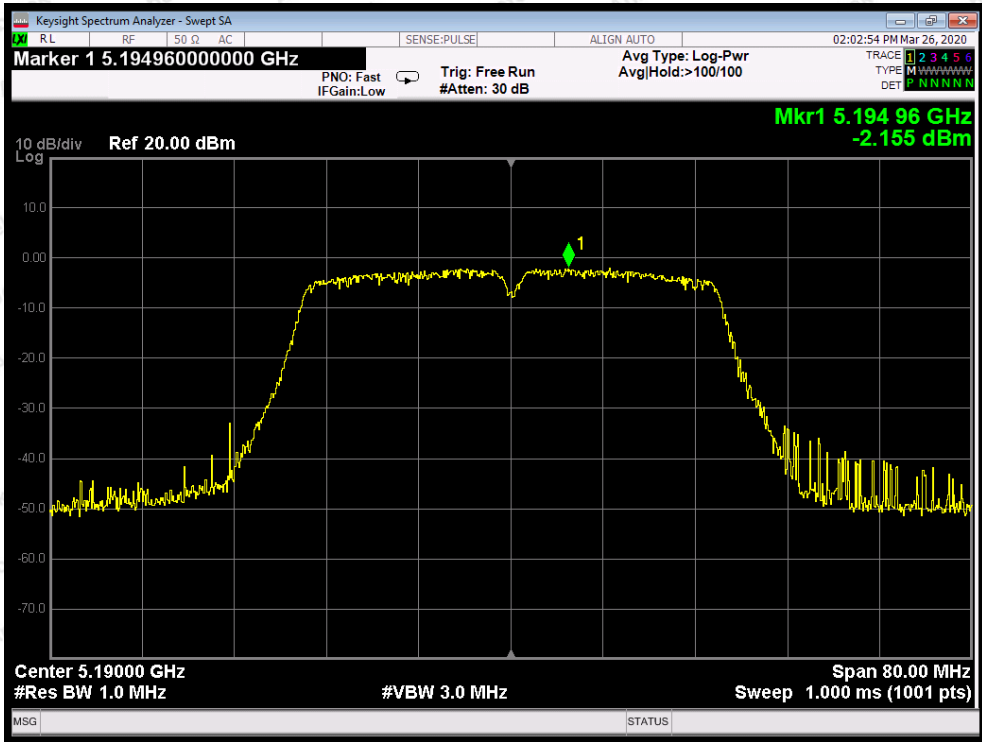

Test Mode: 802.11ac40---Low



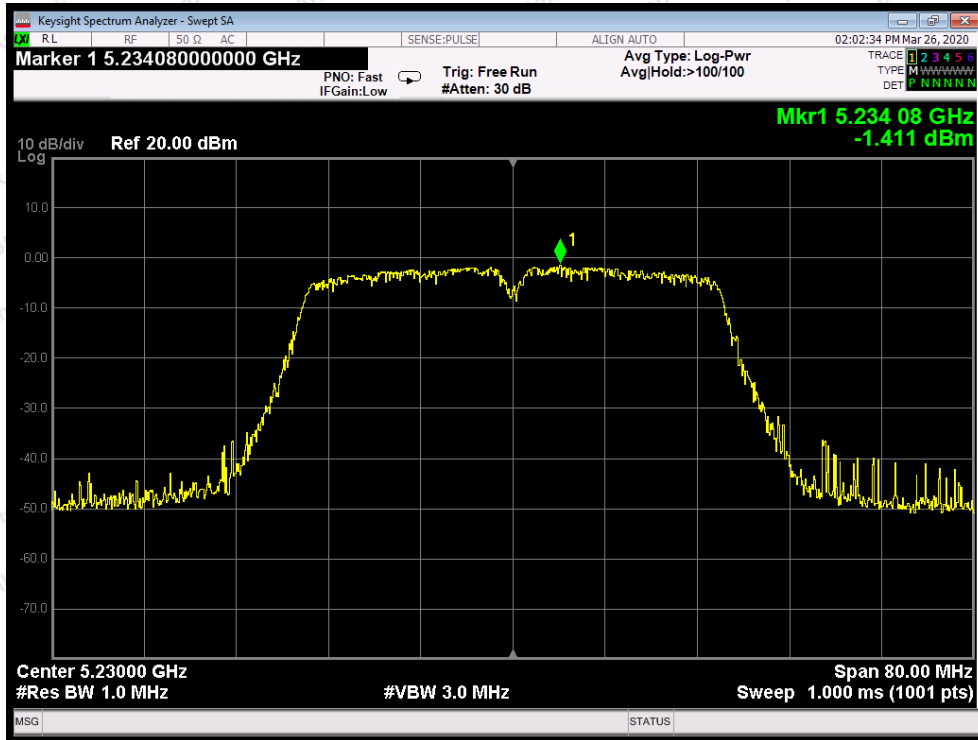

Test Mode: 802.11ac40---High

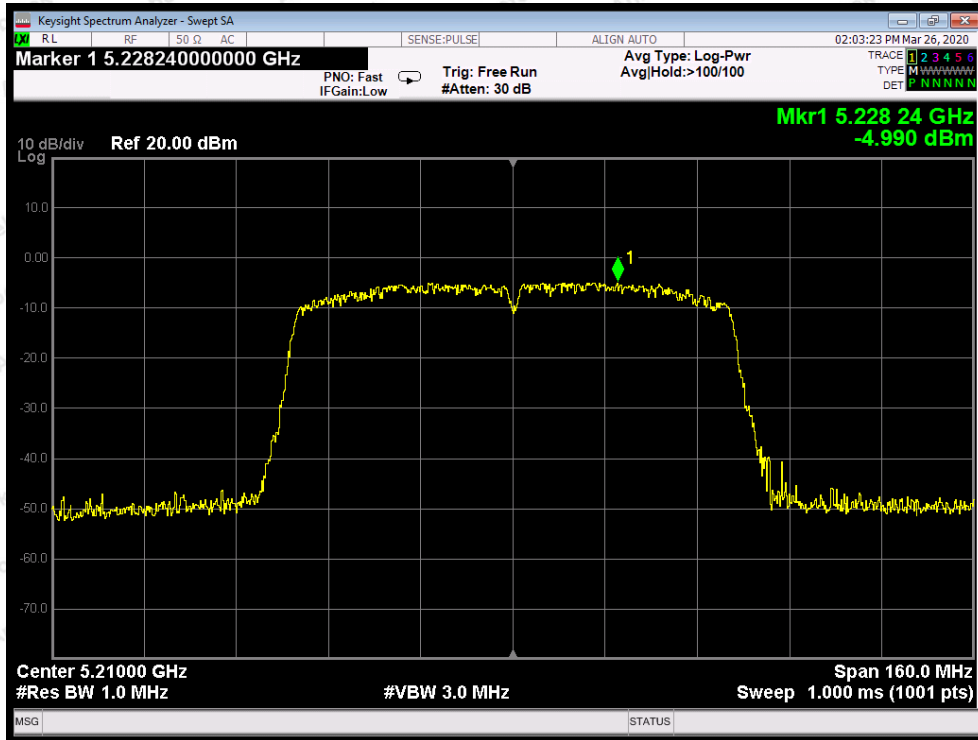

Test Mode: 802.11ac80

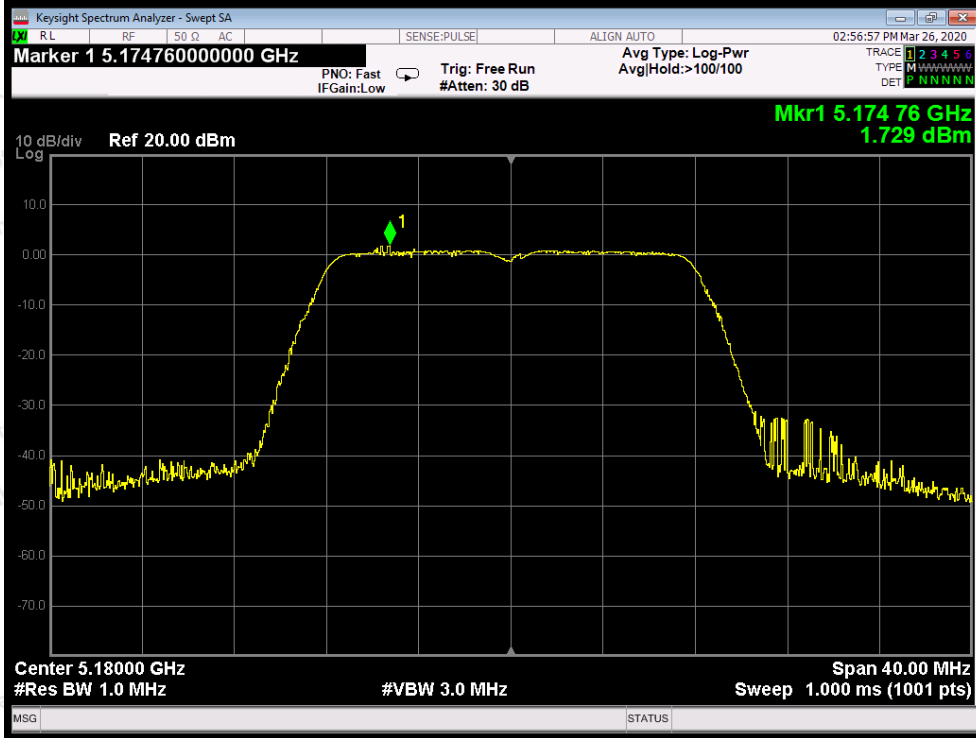

Test Mode: 802.11a--Low

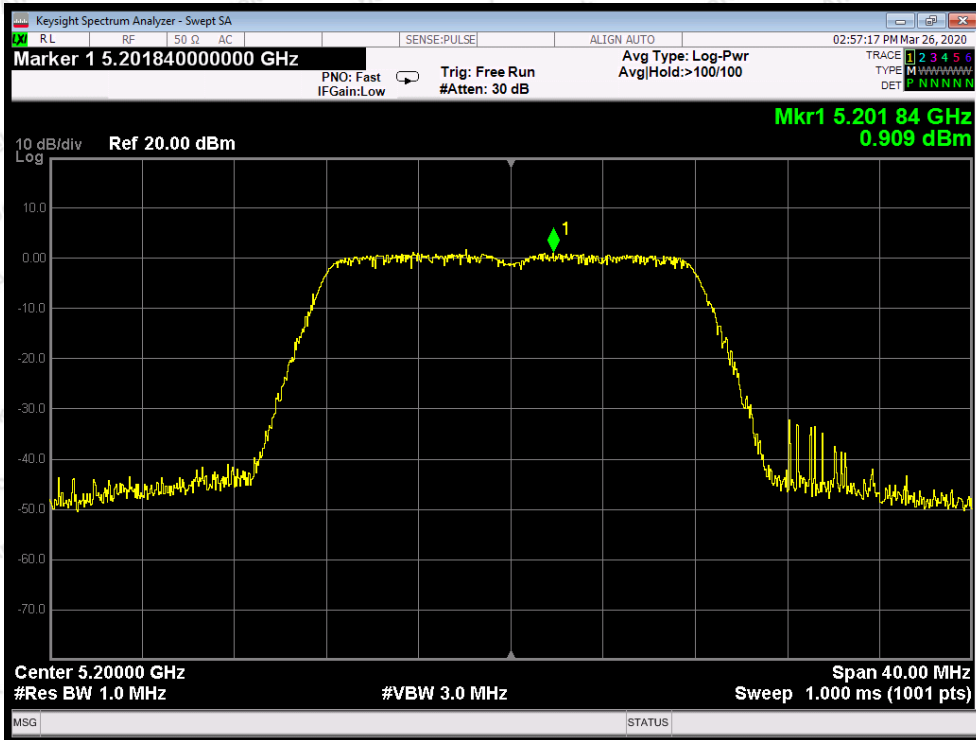

Test Mode: 802.11a---Middle

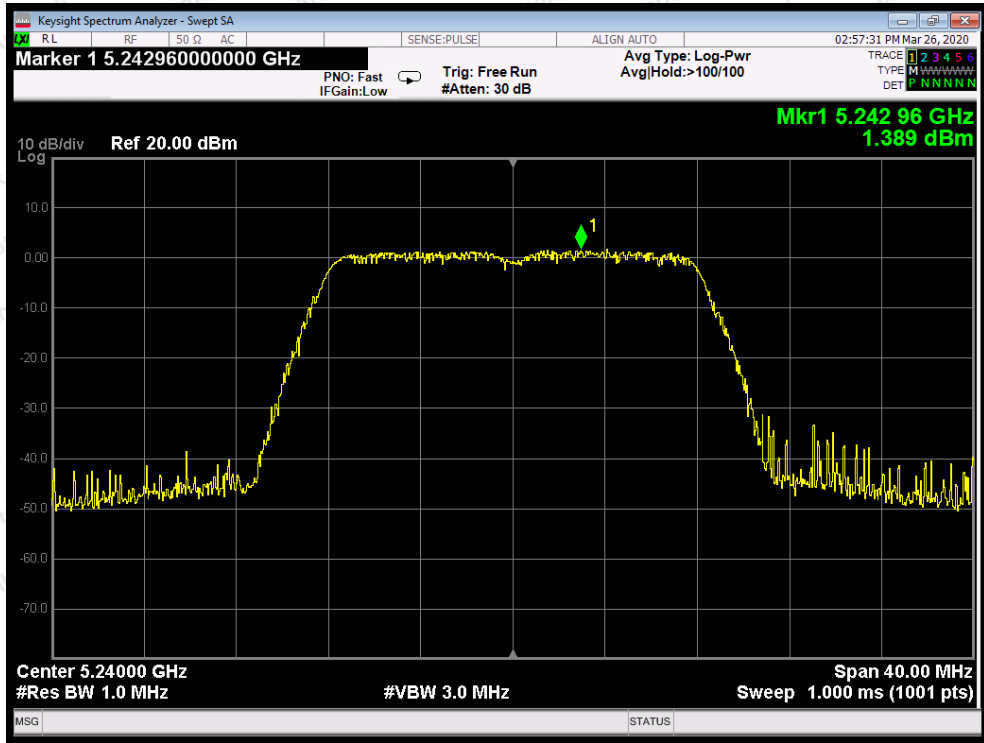

Test Mode: 802.11a---High

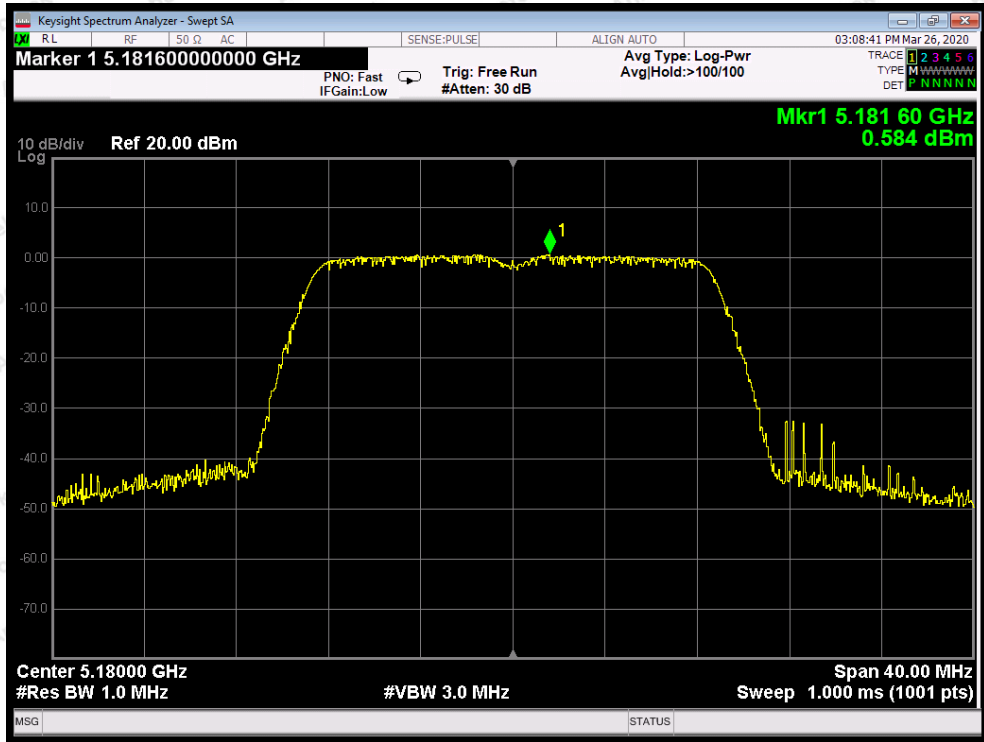

Test Mode: 802.11n20---Low



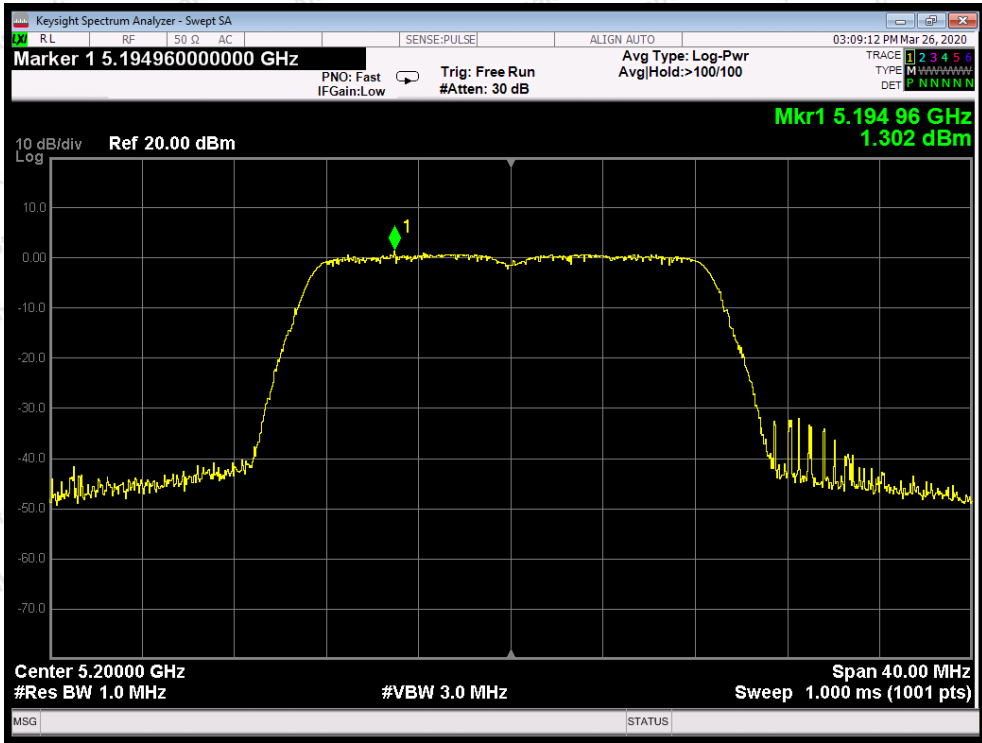

Test Mode: 802.11n20---Middle

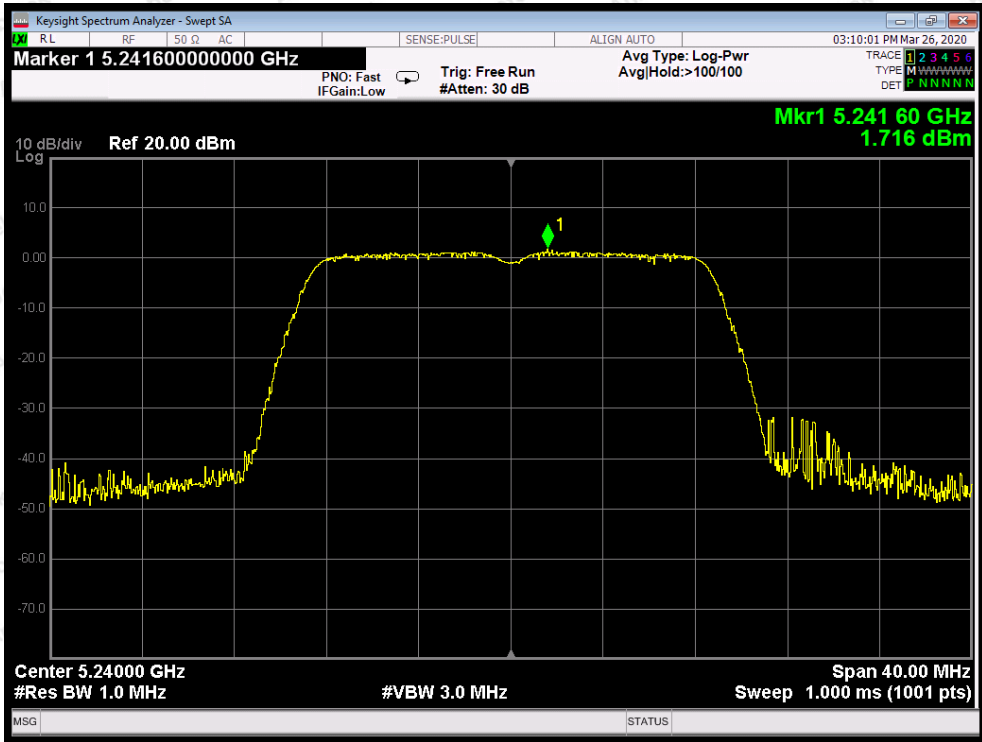

Test Mode: 802.11n20---High

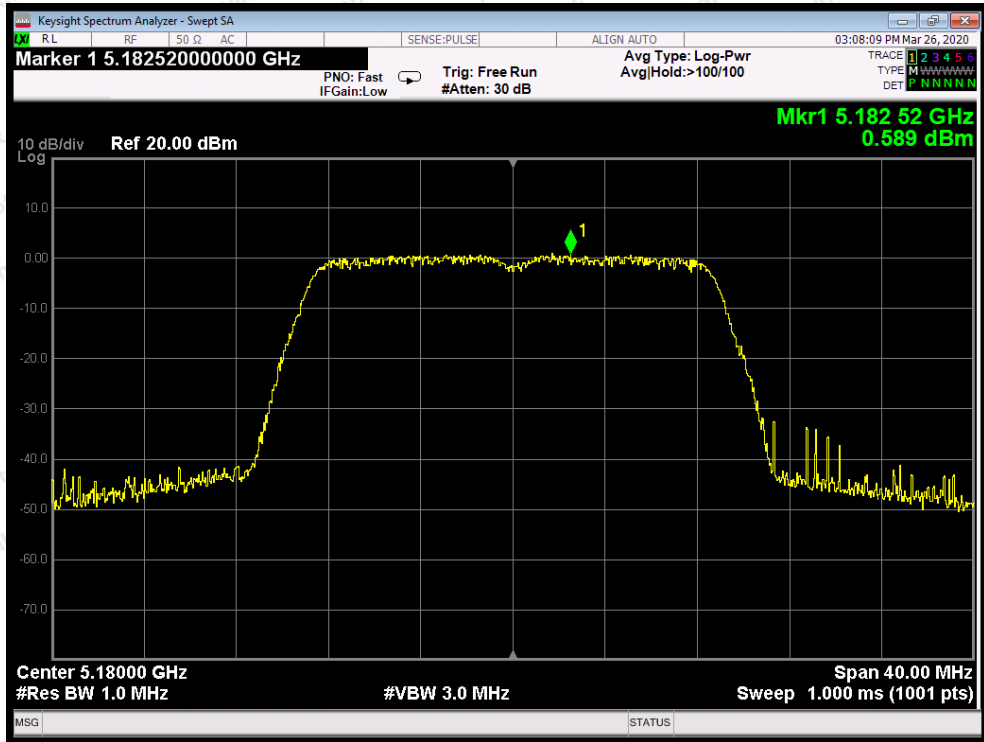

Test Mode: 802.11ac20--Low

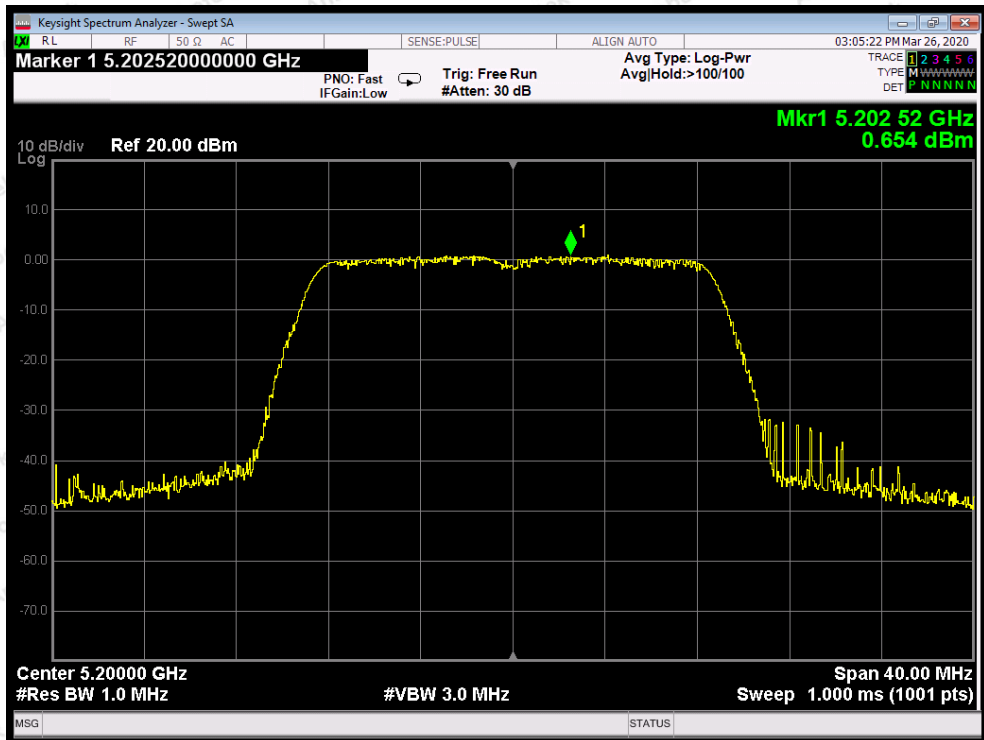

Test Mode: 802.11ac20---Middle

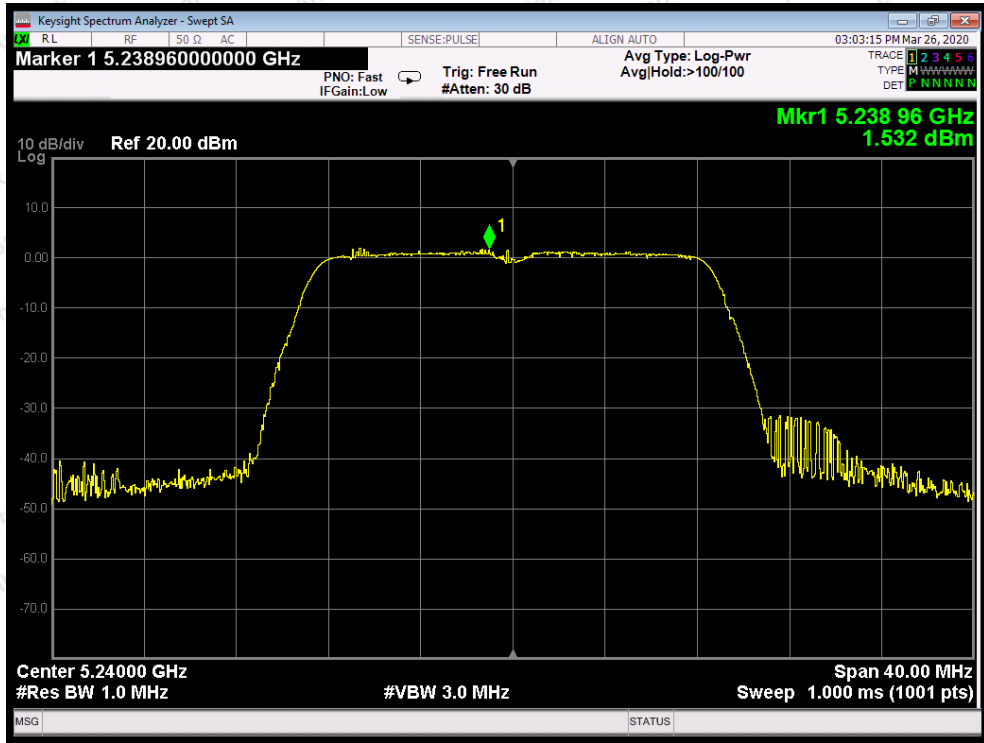

Test Mode: 802.11ac20---High

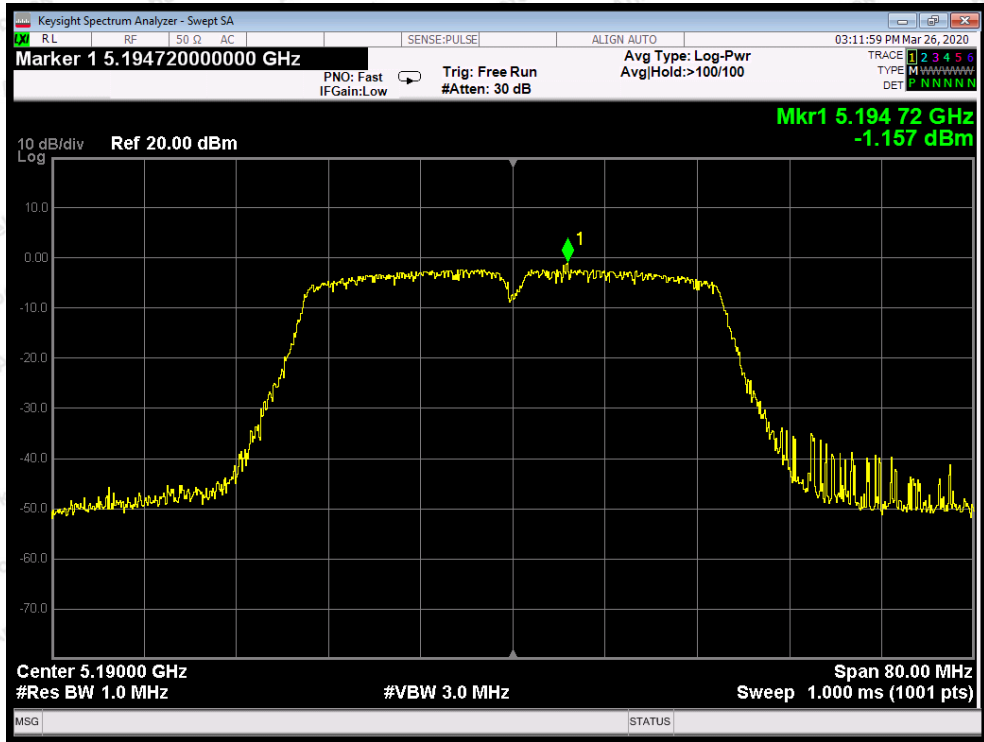

Test Mode: 802.11n40---Low



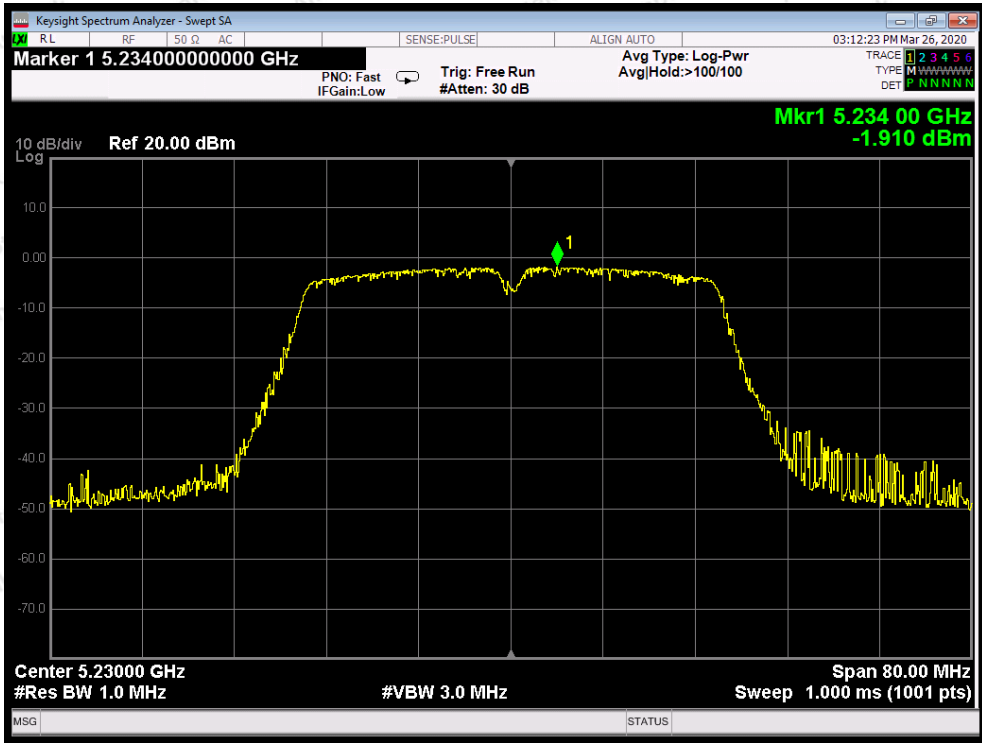

Test Mode: 802.11n40---High

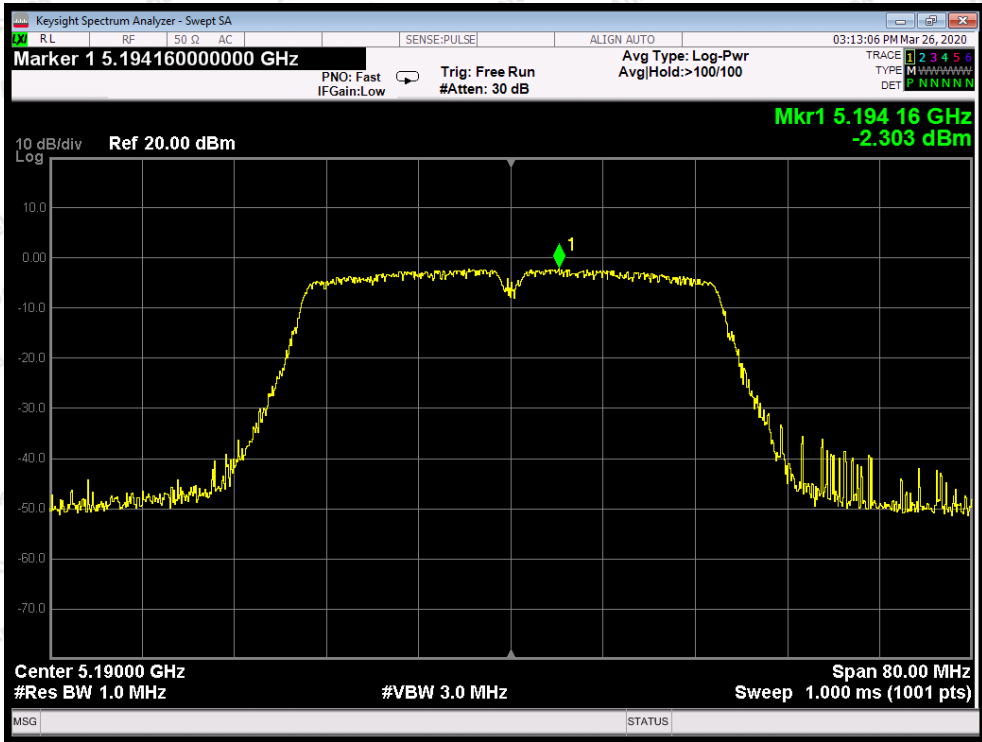

Test Mode: 802.11ac40---Low

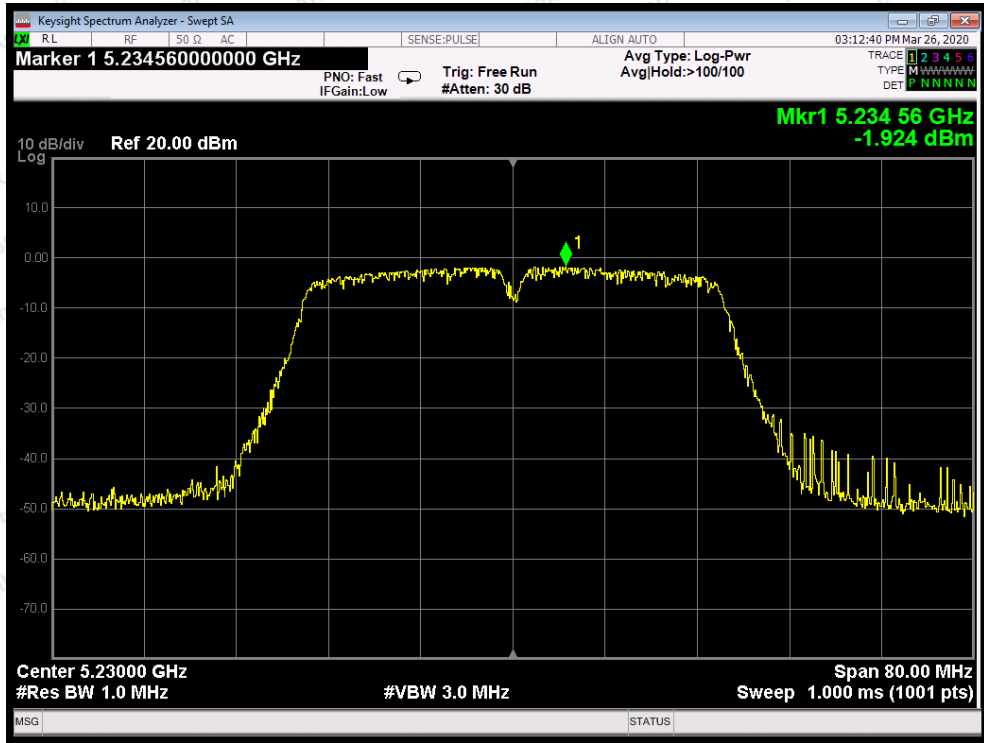

Test Mode: 802.11ac40---High

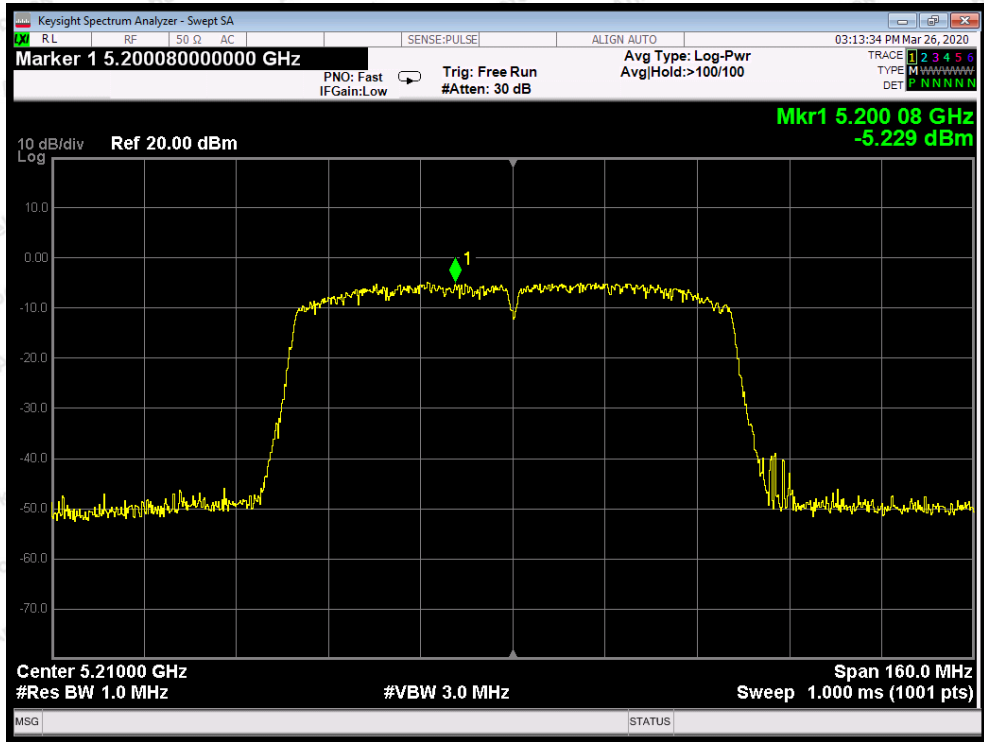

Test Mode: 802.11ac80

## 8. Antenna Requirement

### 8.1. Test Standard and Requirement

Test Standard	FCC Part15 Section 15.203 /15.407
Requirement	<p>1) 15.203 requirement: An intentional radiator shall be designed to ensure that no antenna other than that furnished by the responsible party shall be used with the device. The use of a permanently attached antenna or of an antenna that uses a unique coupling to the intentional radiator, the manufacturer may design the unit so that a broken antenna can be replaced by the user, but the use of a standard antenna jack or electrical connector is prohibited.</p> <p>2) 15.407 requirement: An intentional radiator shall be designed to ensure that no antenna other than that furnished by the responsible party shall be used with the device. The use of a permanently attached antenna or of an antenna that uses a unique coupling to the intentional radiator shall be considered sufficient to comply with the provisions of this section. The manufacturer may design the unit so that a broken antenna can be replaced by the user, but the use of a standard antenna jack or electrical connector is prohibited. This requirement does not apply to carrier current devices or to devices operated under the provisions of §15.211, §15.213, §15.217, §15.219, or §15.221. Further, this requirement does not apply to intentional radiators that must be professionally installed, such as perimeter protection systems and some field disturbance sensors, or to other intentional radiators which, in accordance with §15.31(d), must be measured at the installation site. However, the installer shall be responsible for ensuring that the proper antenna is employed so that the limits in this part are not exceeded.</p>



### 8.2. Antenna Connected Construction

The antenna is a PIFA Antenna which permanently attached, and the best case gain of the antenna is 2 dBi. It complies with the standard requirement.

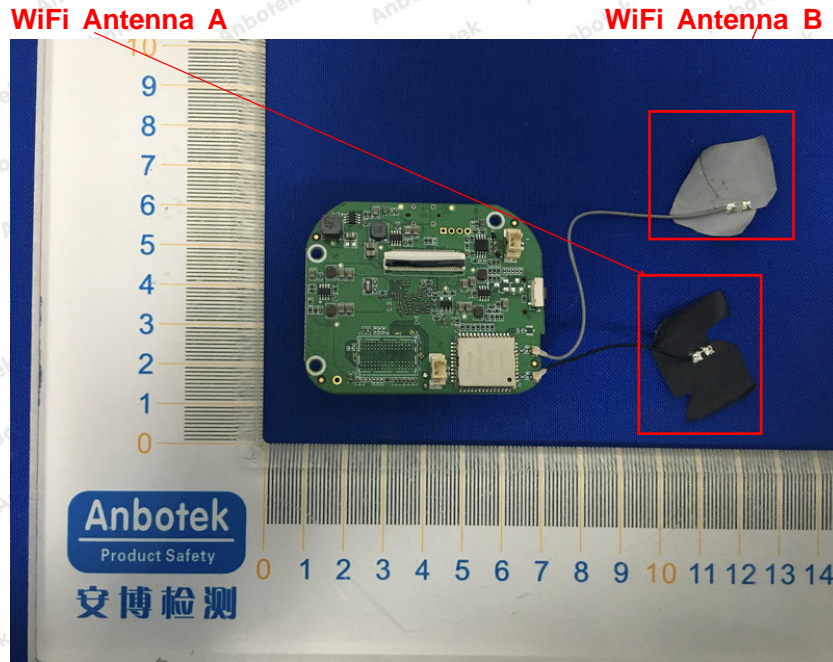

## 9. Frequency Stability

According to the manufacturer, under any normal operating conditions, the working frequency of the product is in the range of 5150-5250MHz.

# APPENDIX I -- PHOTOGRAPH

Reference to the test report 18220WC00022601.

----- End of Report -----

**Shenzhen Anbotek Compliance Laboratory Limited**

Code:AB-RF-05-a

Address: 1/F., Building D, Sogood Science and Technology Park, Sanwei Community,  
Hangcheng Street, Bao'an District, Shenzhen, Guangdong, China.  
Tel: (86) 755-26066440 Fax: (86) 755-26014772 Email: service@anbotek.com

 Hotline  
400-003-0500  
www.anbotek.com