

January 25, 2019

Carnegie Technologies
9737 Great Hills Trail, Suite 260
Austin, Texas 78759

Dear Mark Jones,

Enclosed is the EMC Wireless test report for compliance testing of the Carnegie Technologies, Asset Tracker: model: CR123 as tested to the requirements of Title 47 of the CFR, Ch. 1 (10-1-06 ed.), FCC Part 15 Subpart C for Intentional Radiators.

Thank you for using the services of Eurofins | MET Labs, Inc. If you have any questions regarding these results or if MET can be of further service to you, please feel free to contact me.

Sincerely yours,
EUROFINS | MET LABS, INC.



Joel Huna
Documentation Department

Reference: (\Carnegie Technologies\EMCA99437B-FCC247 Rev. 1)

Certificates and reports shall not be reproduced except in full, without the written permission of Eurofins | MET Labs, Inc. While use of the A2LA logo in this report reflects MET accreditation under these programs, the report must not be used by the client to claim product certification, approval, or endorsement by A2LA or any agency of the Federal Government. This letter of transmittal is not a part of the attached report.



Electromagnetic Compatibility Criteria Test Report

for the

**Carnegie Technologies
Asset Tracker: model: CR123**

Tested under
the FCC Certification Rules
contained in
Title 47 of the CFR, Parts 15 Subpart C
15.247 for Intentional Radiators

MET Report: EMCA99437B-FCC247 Rev. 1

January 25, 2019

Prepared For:

**Carnegie Technologies
9737 Great Hills Trail, Suite 260
Austin, Texas 78759**

Prepared By:
Eurofins | MET Labs, Inc.
13501 McCallen Pass,
Austin, TX 78753

Electromagnetic Compatibility Criteria Test Report

for the

Carnegie Technologies
Asset Tracker: model: CR123

Tested under
the FCC Certification Rules
contained in
Title 47 of the CFR, Parts 15
15.247 Subpart C for Intentional Radiators



Giuliano Messina, Project Engineer
Electromagnetic Compatibility Lab



Joel Huna
Documentation Department

Engineering Statement: The measurements shown in this report were made in accordance with the procedures indicated, and the emissions from this equipment were found to be within the limits applicable. I assume full responsibility for the accuracy and completeness of these measurements, and for the qualifications of all persons taking them. It is further stated that upon the basis of the measurements made, the equipment tested is capable of operation in accordance with the requirements of the FCC Rules Part 15.247 under normal use and maintenance.



John Mason,
Director, Electromagnetic Compatibility Lab

Report Status Sheet

Revision	Report Date	Reason for Revision
∅	January 25, 2019	Initial Issue.
1	February 20, 2019	TCB Corrections

Table of Contents

I.	Executive Summary	1
	A. Purpose of Test	2
	B. Executive Summary	2
II.	Equipment Configuration	3
	A. Overview.....	4
	B. References.....	5
	C. Test Site	5
	D. Measurement Uncertainty	5
	E. Description of Test Sample.....	6
	F. Equipment Configuration.....	7
	G. Support Equipment	7
	H. Mode of Operation.....	7
	I. Method of Monitoring EUT Operation	7
	J. Modifications	7
	a) Modifications to EUT.....	7
	b) Modifications to Test Standard.....	7
	K. Disposition of EUT	7
III.	Electromagnetic Compatibility Criteria for Intentional Radiators	8
	§ 15.203 Antenna Requirement	9
	§ 15.247(a)(1) 20 dB Occupied Bandwidth.....	10
	§ 15.247(a)(1) Average Time of Occupancy (Dwell Time)	12
	§ 15.247(a)(1) Number of RF Channels	13
	§ 15.247(a)(1) RF Channel Separation	14
	§ 15.247(b) Power Output	15
	§ 15.247(d) Radiated Spurious Emissions Requirements and Band Edge.....	17
	§ 15.247(d) RF Conducted Spurious Emissions Requirements and Band Edge.....	26
	§ 15.247(g)(h) Declaration Statements for FHSS	31
IV.	Test Equipment	33
V.	Certification & User’s Manual Information	35
	A. Certification Information	36
	B. Label and User’s Manual Information	40

List of Tables

Table 1. Executive Summary of EMC Part 15.247 Compliance Testing	2
Table 2. EUT Summary Table.....	4
Table 3. References	5
Table 4. Uncertainty Calculations Summary.....	5
Table 5. Equipment Configuration	7
Table 6. Antenna List	9
Table 7. 20 dB Occupied Bandwidth, Test Results	10
Table 8. Power Output, Test Results	15
Table 9. Restricted Bands of Operation.....	17
Table 10. Radiated Emissions Limits Calculated from FCC Part 15, § 15.209 (a)	18
Table 11. Test Equipment List	34

List of Plots

Plot 1. 20 dB Occupied Bandwidth, 902.3 MHz, 164.663 kHz.....	11
Plot 2. 20 dB Occupied Bandwidth, 908.7 MHz, 164.362 kHz.....	11
Plot 3. 20 dB Occupied Bandwidth, 914.9 MHz, 166.328 kHz.....	11
Plot 4. Dwell Time, 20s.....	12
Plot 5. Dwell Time, Single Pulse.....	12
Plot 6. Number of Channels, 64 Channels.....	13
Plot 7. Channel Separation, 200 kHz.....	14
Plot 8. Power Output, 902.3 MHz, 11.36 dBm	16
Plot 9. Power Output, 908.7 MHz, 11.13 dBm	16
Plot 10. Power Output, 914.9 MHz, 11.58 dBm.....	16
Plot 11. Radiated Spurious Emissions, 902.3 MHz, 30 – 1000 MHz.....	19
Plot 12. Radiated Spurious Emissions, 902.3 MHz, 1 – 10 GHz, Average	19
Plot 13. Radiated Spurious Emissions, 902.3 MHz, 1 – 10 GHz, Peak.....	19
Plot 14. Radiated Spurious Emissions, 908.7 MHz, 30 – 1000 MHz.....	20
Plot 15. Radiated Spurious Emissions, 908.7 MHz, 1 – 10 GHz, Average	20
Plot 16. Radiated Spurious Emissions, 908.7 MHz, 1 – 10 GHz, Peak.....	20
Plot 17. Radiated Spurious Emissions, 914.9 MHz, 30 – 1000 MHz.....	21
Plot 18. Radiated Spurious Emissions, 914.9 MHz, 1 – 10 GHz, Average	21
Plot 19. Radiated Spurious Emissions, 914.9 MHz, 1 – 10 GHz, Peak.....	21
Plot 20. Radiated Restricted Band Edge, 902.3 MHz.....	22
Plot 21. Radiated Restricted Band Edge, 914.9 MHz.....	22
Plot 22. Conducted Spurious Emissions, 902.3 MHz, 30 MHz – 10 GHz	27
Plot 23. Conducted Spurious Emissions, 908.7 MHz, 30 MHz – 10 GHz	27
Plot 24. Conducted Spurious Emissions, 914.9 MHz, 30 MHz – 10 GHz	27
Plot 25. Conducted Band Edge, 902.3 MHz.....	28
Plot 26. Conducted Band Edge, 914.9 MHz.....	28
Plot 27. Conducted Band Edge, Hopping, Low	29
Plot 28. Conducted Band Edge, Hopping, High.....	29

List of Figures

Figure 1. Asset Tracker: model: CR123 Block Diagram containing LoRa Module.....	6
Figure 2. LoRa Module Block Diagram.....	6
Figure 3. Block Diagram, Occupied Bandwidth Test Setup.....	10
Figure 4. Power Output Test Setup	15
Figure 5. Block Diagram, Conducted Spurious Emissions Test Setup.....	26

List of Photographs

Photograph 1. Radiated Spurious Emissions, Below 1 GHz, Antenna, Test Setup.....	23
Photograph 2. Radiated Spurious Emissions, Below 1 GHz, Front, Test Setup.....	23
Photograph 3. Radiated Spurious Emissions, Below 1 GHz, Rear, Test Setup.....	24
Photograph 4. Radiated Spurious Emissions, Above 1 GHz, Antenna, Test Setup.....	24
Photograph 5. Radiated Spurious Emissions, Above 1 GHz, Front, Test Setup	25
Photograph 6. Radiated Spurious Emissions, Above 1 GHz, Rear, Test Setup.....	25
Photograph 7. Conducted Spurious Emissions, Test Setup	30

List of Terms and Abbreviations

AC	Alternating Current
ACF	Antenna Correction Factor
Cal	Calibration
<i>d</i>	Measurement Distance
dB	Decibels
dB μ A	Decibels above one microamp
dB μ V	Decibels above one microvolt
dB μ A/m	Decibels above one microamp per meter
dB μ V/m	Decibels above one microvolt per meter
DC	Direct Current
E	Electric Field
DSL	Digital Subscriber Line
ESD	Electrostatic Discharge
EUT	Equipment Under Test
<i>f</i>	Frequency
FCC	Federal Communications Commission
GRP	Ground Reference Plane
H	Magnetic Field
HCP	Horizontal Coupling Plane
Hz	Hertz
IEC	International Electrotechnical Commission
kHz	kilohertz
kPa	kilopascal
kV	kilovolt
LISN	Line Impedance Stabilization Network
MHz	Megahertz
μ H	microhenry
μ	microfarad
μ s	microseconds
NEBS	Network Equipment-Building System
PRF	Pulse Repetition Frequency
RF	Radio Frequency
RMS	Root-Mean-Square
TWT	Traveling Wave Tube
V/m	Volts per meter
VCP	Vertical Coupling Plane

I. Executive Summary

A. Purpose of Test

An EMC evaluation was performed to determine compliance of the Carnegie Technologies Asset Tracker: model: CR123, with the requirements of Part 15, §15.247. All references are to the most current version of Title 47 of the Code of Federal Regulations in effect. In accordance with §2.1033, the following data is presented in support of the Certification of the Asset Tracker: model: CR123. Carnegie Technologies should retain a copy of this document which should be kept on file for at least two years after the manufacturing of the Asset Tracker: model: CR123, has been **permanently** discontinued.

B. Executive Summary

The following tests were conducted on a sample of the equipment for the purpose of demonstrating compliance with Part 15, §15.247, in accordance with Carnegie Technologies, purchase order number POLABS1767. All tests were conducted using measurement procedure ANSI C63.4-2014 and ANSI C63.10-2013.

FCC Reference 47 CFR Part 15.247:2005	Description	Compliance
Title 47 of the CFR, Part 15 §15.203	Antenna Requirement	Compliant
Title 47 of the CFR, Part 15 §15.207(a)	Conducted Emission Limits	Not Applicable
Title 47 of the CFR, Part 15 §15.247(a)(1)	20 dB Occupied Bandwidth	Compliant
Title 47 of the CFR, Part 15 §15.247(a)(1)	Average Time of Occupancy (Dwell Time)	Compliant
Title 47 of the CFR, Part 15 §15.247(a)(1)	Number of RF Channels	Compliant
Title 47 of the CFR, Part 15 §15.247(a)(1)	RF Channel Separation	Compliant
Title 47 of the CFR, Part 15 §15.247(b)	Power Output	Compliant
Title 47 of the CFR, Part 15 §15.247(d); §15.209; §15.205	Radiated Spurious Emissions	Compliant
Title 47 of the CFR, Part 15 §15.247(d)	Spurious Conducted Emissions	Compliant
Title 47 of the CFR, Part 15 §15.247(g) & (h)	Declaration Statements for FHSS	Compliant
Title 47 of the CFR, Part 15 §15.247(i)	Maximum Permissible Exposure (MPE)	Compliant

Table 1. Executive Summary of EMC Part 15.247 Compliance Testing

II. Equipment Configuration

A. Overview

Eurofins | MET Labs, Inc. was contracted by Carnegie Technologies to perform testing on the Asset Tracker: model: CR123, under Carnegie Technologies’ purchase order number POLABS1767.

This document describes the test setups, test methods, required test equipment, and the test limit criteria used to perform compliance testing of the Carnegie Technologies, Asset Tracker: model: CR123.

The results obtained relate only to the item(s) tested.

Model(s) Tested:	Asset Tracker: model: CR123	
Model(s) Covered:	LV-AT3-172	
EUT Specifications:	Primary Power: 3 VDC	
	FCC ID: 2ARIP-0002	
	Type of Modulations:	LoRa Modulation
	Equipment Code:	DSS
	Peak RF Output Power:	11.58 dBm
	EUT Frequency Ranges:	902.3-914.9 MHz
Analysis:	The results obtained relate only to the item(s) tested.	
Environmental Test Conditions:	Temperature: 15-35° C	
	Relative Humidity: 30-60%	
	Barometric Pressure: 860-1060 mbar	
Evaluated by:	Giuliano Messina	
Report Date(s):	January 25, 2019	

Table 2. EUT Summary Table

B. References

CFR 47, Part 15, Subpart C	Federal Communication Commission, Code of Federal Regulations, Title 47, Part 15: General Rules and Regulations, Allocation, Assignment, and Use of Radio Frequencies
ANSI C63.4:2014	Methods and Measurements of Radio-Noise Emissions from Low-Voltage Electrical And Electronic Equipment in the Range of 9 kHz to 40 GHz
ISO/IEC 17025:2005	General Requirements for the Competence of Testing and Calibration Laboratories
ANSI C63.10-2013	American National Standard for Testing Unlicensed Wireless Devices

Table 3. References

C. Test Site

All testing was performed at Eurofins | MET Labs, Inc., 13501 McCallen Pass, Austin, TX 78753. All equipment used in making physical determinations is accurate and bears recent traceability to the National Institute of Standards and Technology.

Radiated Emissions measurements were performed in a 10 meter semi-anechoic chamber (equivalent to an Open Area Test Site). In accordance with §2.948(a)(3), a complete site description is contained at MET Laboratories.

D. Measurement Uncertainty

Test Method	Typical Expanded Uncertainty	K	Confidence Level
RF Frequencies	±4.52 Hz	2	95%
RF Power Conducted Spurious Emissions	±2.97 dB	2	95%
RF Power Radiated Emissions	±2.95 dB	2	95%

Table 4. Uncertainty Calculations Summary

E. Description of Test Sample

The Carnegie Technologies Asset Tracker: model: CR123, Equipment Under Test (EUT), provides GPS location data and sends that information to the Longview infrastructure. It is intended to be used in a variety of environments for indicating the location of the asset to which the tag is attached.

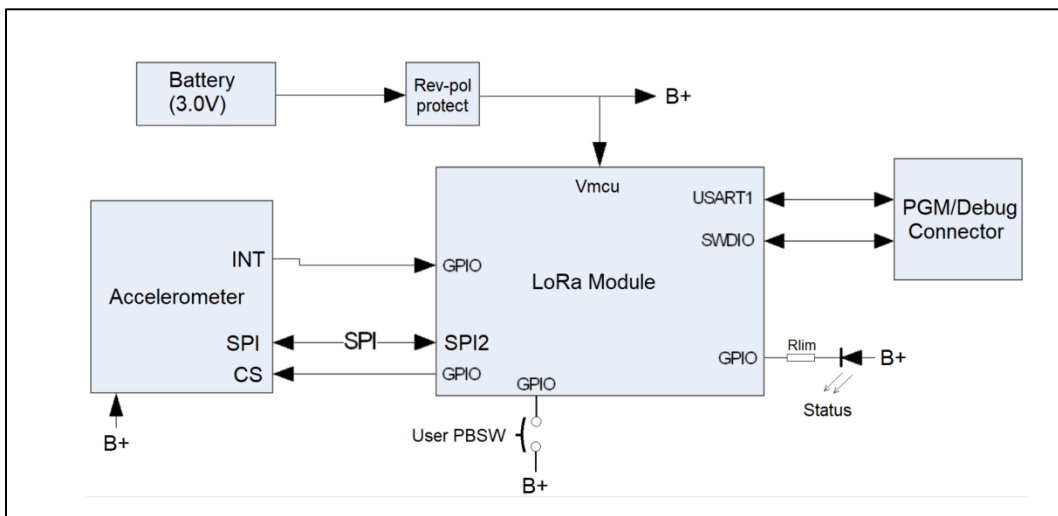

Figure 1. Asset Tracker: model: CR123 Block Diagram containing LoRa Module

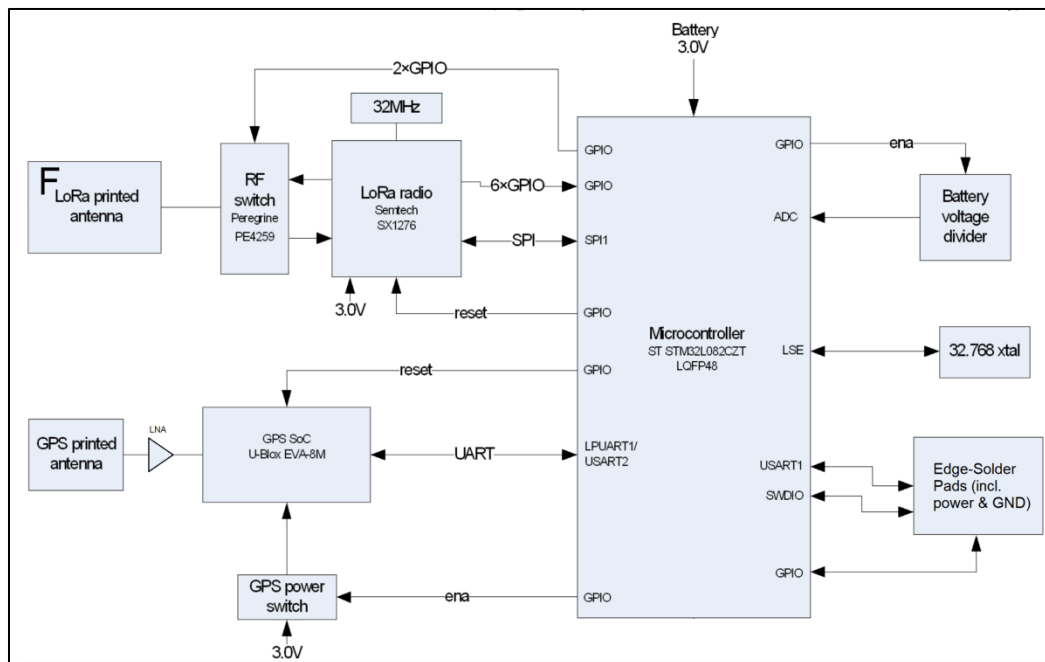

Figure 2. LoRa Module Block Diagram

F. Equipment Configuration

The EUT was set up as outlined in Figures 1 and 2. All cards, racks, etc., incorporated as part of the EUT is included in the following list.

Ref. ID	Name / Description	Model Number	Part Number	Serial Number	Revision
N/A	Asset Tracker: model: CR123	LV-AT3-172	N/A	N/A	N/A

Table 5. Equipment Configuration

G. Support Equipment

The EUT did not require any support equipment for operation or monitoring.

H. Mode of Operation

Under current typical conditions the EUT transmits data sporadically in the 915MHz LoRa ISM bands. For test purposes, a special software load is installed that permits the 915MHz LoRa to transmit a constant packet approximately every 250msec. Power to the unit will be supplied by CR123 batteries.

I. Method of Monitoring EUT Operation

A spectrum analyzer is used to verify that each EUT is transmitting.

J. Modifications

- a) **Modifications to EUT**
No modifications were made to the EUT.
- b) **Modifications to Test Standard**
No modifications were made to the test standard.

K. Disposition of EUT

The test sample including all support equipment submitted to the Electro-Magnetic Compatibility Lab for testing was returned to Carnegie Technologies upon completion of testing.

III. Electromagnetic Compatibility Criteria for Intentional Radiators

Electromagnetic Compatibility Criteria for Intentional Radiators

§ 15.203 Antenna Requirement

Test Requirement: § 15.203: An intentional radiator shall be designed to ensure that no antenna other than that furnished by the responsible party shall be used with the device. The use of a permanently attached antenna or of an antenna that uses a unique coupling to the intentional radiator shall be considered sufficient to comply with the provisions of this section. The manufacturer may design the unit so that a broken antenna can be replaced by the user, but the use of a standard antenna jack or electrical connector is prohibited.

The structure and application of the EUT were analyzed to determine compliance with Section 15.203 of the Rules. Section 15.203 states that the subject device must meet at least one of the following criteria:

- a.) Antenna must be permanently attached to the unit.
- b.) Antenna must use a unique type of connector to attach to the EUT.
- c.) Unit must be professionally installed. Installer shall be responsible for verifying that the correct antenna is employed with the unit.

Test Results: The EUT as tested is compliant the criteria of §15.203. EUT utilizes an integrated PCB antenna as shown in the list below.

Test Engineer(s): Giuliano Messina

Test Date(s): November 19, 2018

Gain	Type	Model	Manufacturer
+2	PCB trace (PIFA)	N/A	N/A

Table 6. Antenna List

Electromagnetic Compatibility Criteria for Intentional Radiators

§ 15.247(a)(1) 20 dB Occupied Bandwidth

Test Requirements: § 15.247(a): Operation under the provisions of this section is limited to frequency hopping and digitally modulated intentional radiators that comply with the following provisions:

For systems using digital modulation techniques, the EUT may operate in the 902-928 MHz, 2400-2483.5 MHz and 5725-5850 MHz bands. For DTS, the minimum 6 dB bandwidth shall be at least 500 kHz. For frequency hopping systems, the EUT shall have hopping channel carrier frequencies separated by a minimum of 25 kHz or the 20 dB bandwidth of the hopping channel, whichever is greater.

Test Procedure: The bandwidth of the fundamental frequency was measured with the spectrum analyzer using a RBW approximately equal to 1% of the total emission bandwidth. The 20 dB bandwidth was measured and recorded.

Test Results The EUT was compliant with § 15.247 (a)(2). No anomalies detected.

Channel	Frequency (MHz)	20dB BW (kHz)
Low	902.3	164.663
Mid	908.7	164.362
High	914.9	166.328

Table 7. 20 dB Occupied Bandwidth, Test Results

Test Engineer(s): Giuliano Messina

Test Date(s): December 27, 2018

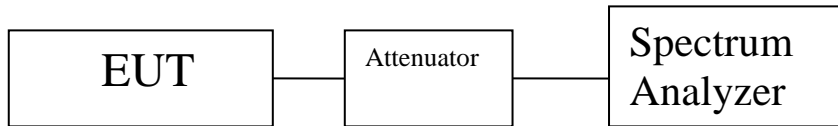
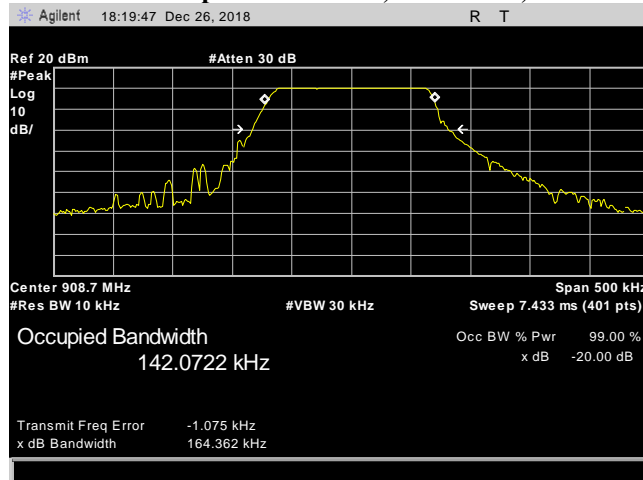

Figure 3. Block Diagram, Occupied Bandwidth Test Setup

20 dB Occupied Bandwidth Test Results



Plot 1. 20 dB Occupied Bandwidth, 902.3 MHz, 164.663 kHz



Plot 2. 20 dB Occupied Bandwidth, 908.7 MHz, 164.362 kHz

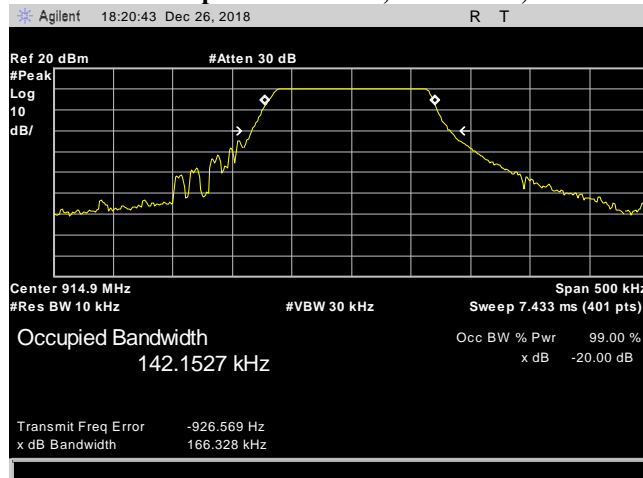

Plot 3. 20 dB Occupied Bandwidth, 914.9 MHz, 166.328 kHz

Electromagnetic Compatibility Criteria for Intentional Radiators

§ 15.247(a)(1) Average Time of Occupancy (Dwell Time)

Remarks: The average time of occupancy on any frequency shall not be greater than 0.4 seconds within a 20 second period.

Test Results: The EUT average time of occupancy is 0.39 seconds within a 20 second period.

Dwell Time

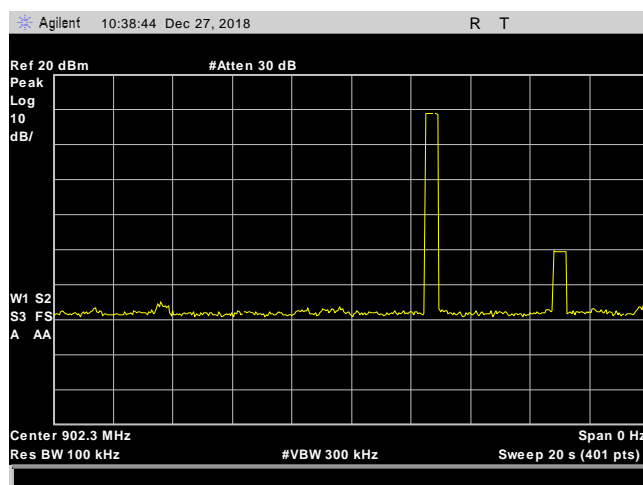

Plot 4. Dwell Time, 20s

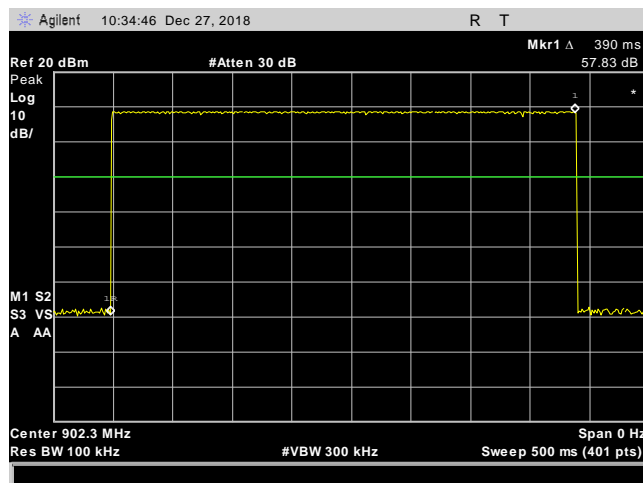

Plot 5. Dwell Time, Single Pulse

Electromagnetic Compatibility Criteria for Intentional Radiators

§ 15.247(a)(1) Number of RF Channels

Remarks: For frequency hopping systems operating in the 902-928 MHz band: if the 20 dB bandwidth of the hopping channel is less than 250 kHz, the system shall use at least 50 hopping frequencies.

Test Results: Total hopping channels is 64. The EUT meets the specifications of Section 15.247(a) (1) (i) for Number of Hopping Channels.

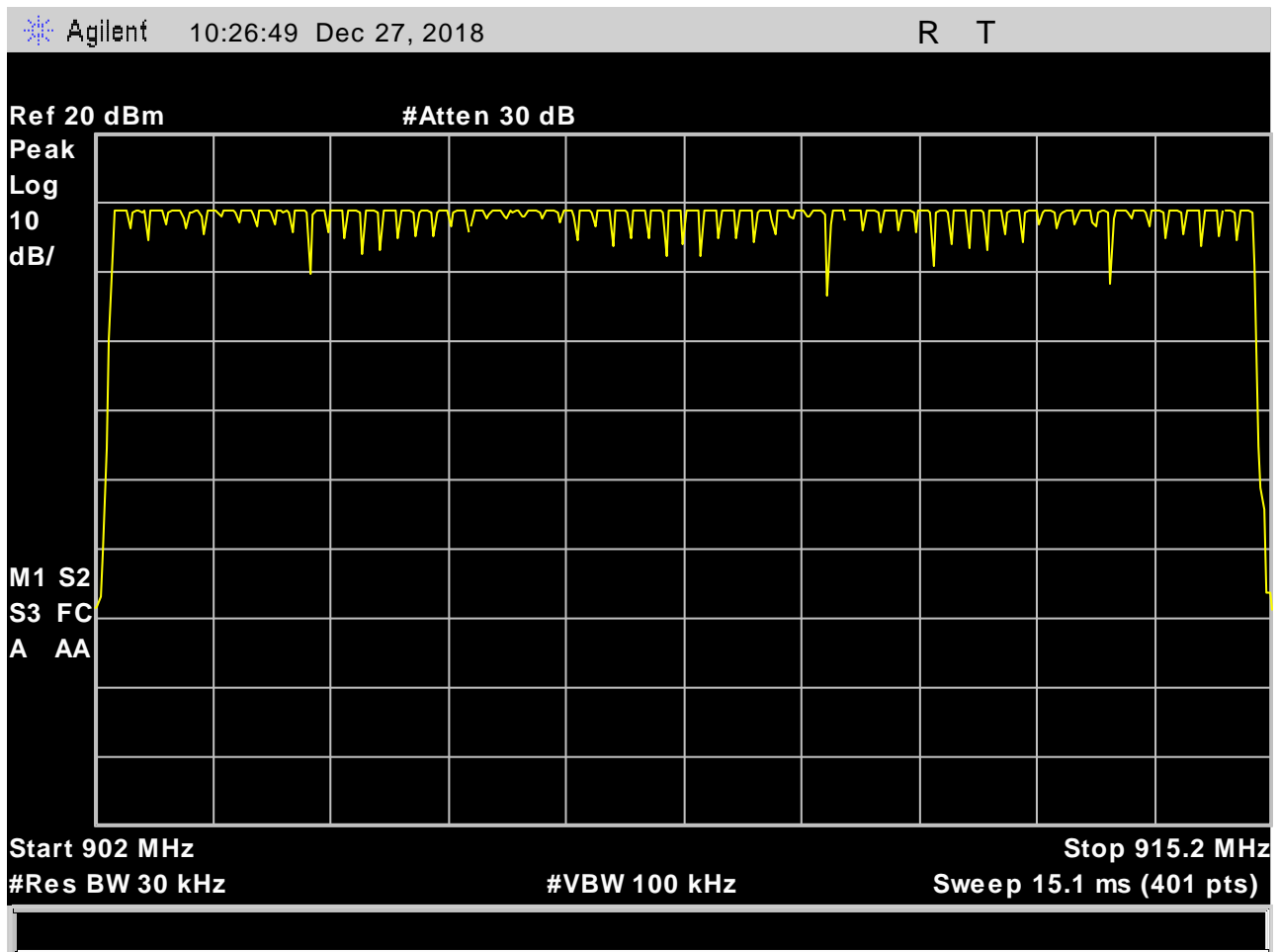

Plot 6. Number of Channels, 64 Channels

Electromagnetic Compatibility Criteria for Intentional Radiators

§ 15.247(a)(1) RF Channel Separation

Requirement: Frequency hopping systems shall have hopping channel carrier frequencies separated by a minimum of 25 kHz or the 20 dB bandwidth of the hopping channel, whichever is greater. Alternatively, frequency hopping systems operating in the 2400–2483.5 MHz band may have hopping channel carrier frequencies that are separated by 25 kHz or two-thirds of the 20 dB bandwidth of the hopping channel, whichever is greater, provided the systems operate with an output power no greater than 125 mW.

Test Results The EUT 20dB bandwidth is 166kHz, and the channel separation is 200kHz.

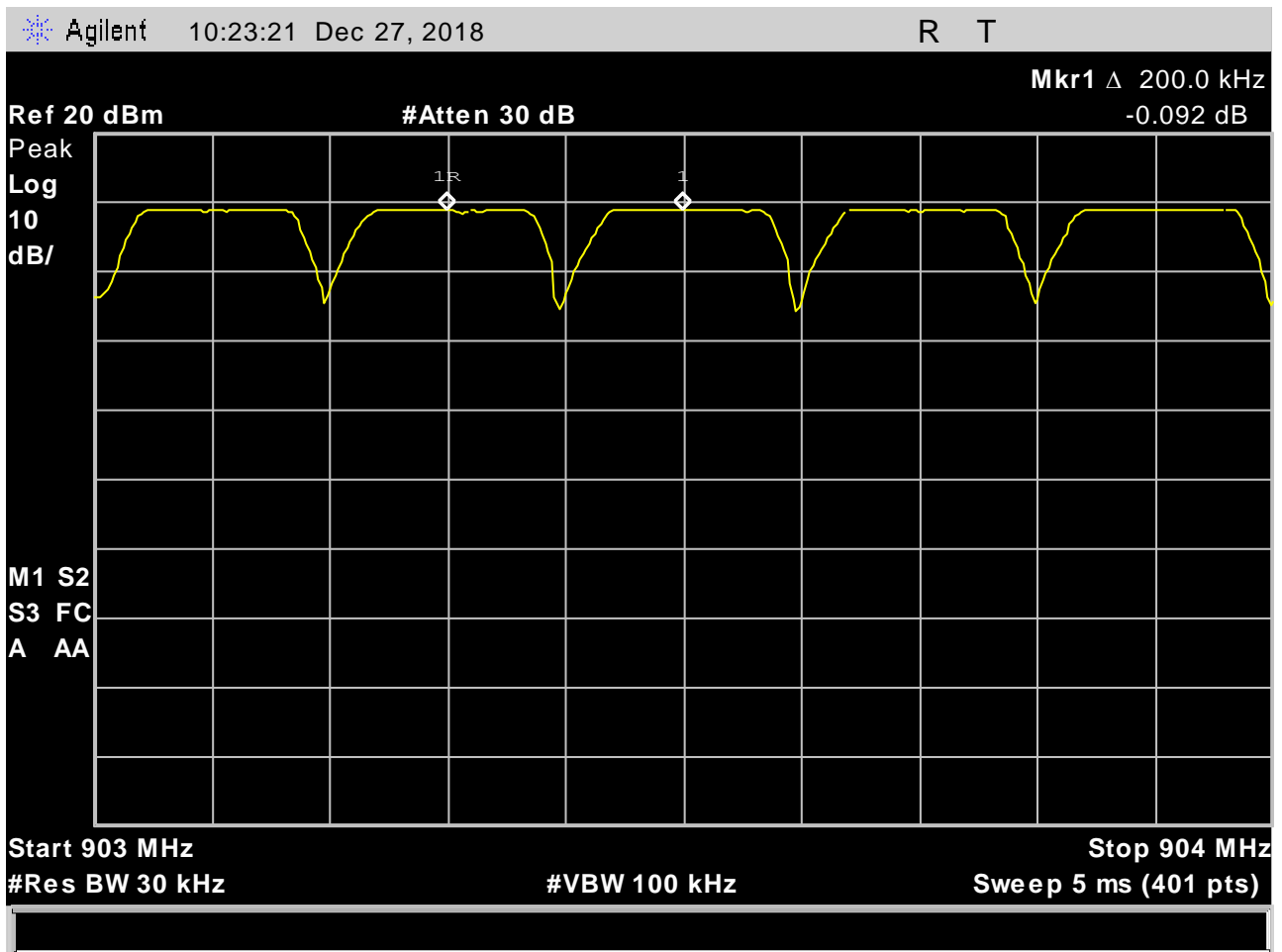

Plot 7. Channel Separation, 200 kHz

Electromagnetic Compatibility Criteria for Intentional Radiators

§ 15.247(b) Power Output

Test Requirements: §15.247(b)(2): For frequency hopping systems operating in the 902-928 MHz band: 1 watt for systems employing at least 50 hopping channels.

Test Procedure: The transmitter was connected to a calibrated spectrum analyzer. The EUT was measured at the low, mid and high channels of each band. The EUT was utilizes a 2dBi PCB Antenna, so the maximum power allowed is 30dBm.

Test Results: The EUT was compliant with the Power Output limits of §15.247(b).

Channel	Frequency (MHz)	Output Power (dBm)
Low	902.3	11.36
Mid	908.7	11.13
High	914.9	11.58

Table 8. Power Output, Test Results

Test Engineer(s): Giuliano Messina

Test Date(s): December 27, 2018

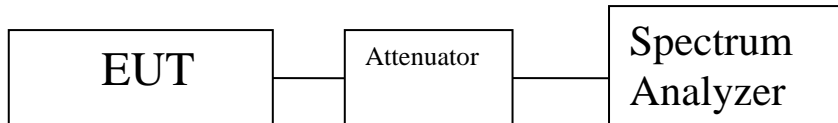
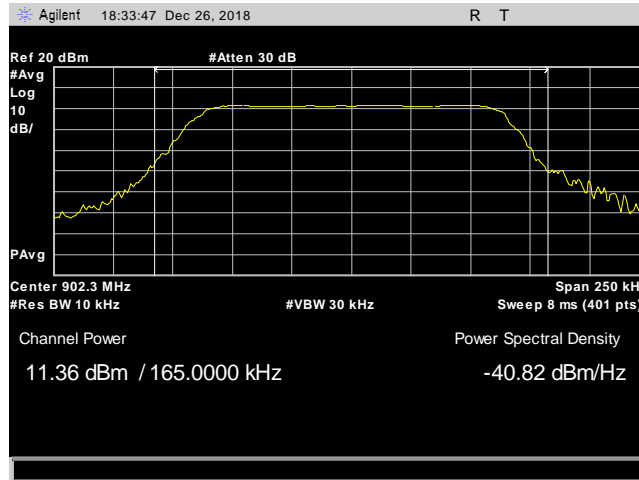
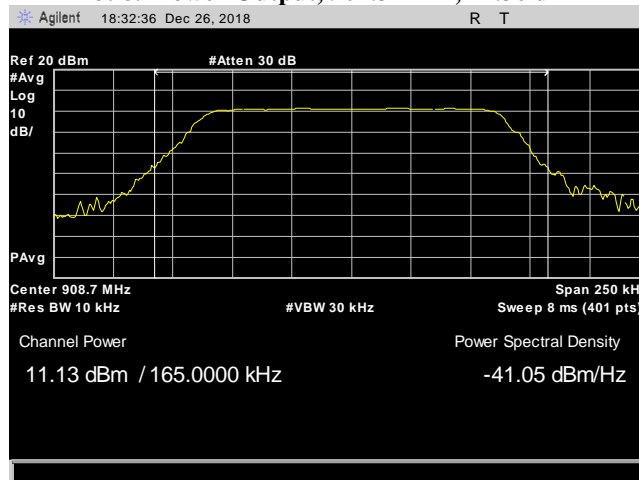

Figure 4. Power Output Test Setup

Power Output Test Results



Plot 8. Power Output, 902.3 MHz, 11.36 dBm



Plot 9. Power Output, 908.7 MHz, 11.13 dBm



Plot 10. Power Output, 914.9 MHz, 11.58 dBm

Electromagnetic Compatibility Criteria for Intentional Radiators

§ 15.247(d) Radiated Spurious Emissions Requirements and Band Edge

Test Requirements: §15.247(d); §15.205: Emissions outside the frequency band.

§15.247(d): In any 100 kHz bandwidth outside the frequency band in which the spread spectrum or digitally modulated intentional radiator is operating, the radio frequency power that is produced by the intentional radiator shall be at least 20 dB below that in the 100 kHz bandwidth within the band that contains the highest level of the desired power, based on either an RF conducted or a radiated measurement. Attenuation below the general limits specified in § 15.209(a) is not required. In addition, radiated emissions which fall in the restricted bands, as defined in § 15.205(a), must also comply with the radiated emission limits specified in § 15.209(a).

§15.205(a): Except as shown in paragraph (d) of this section, only spurious emissions are permitted in any of the frequency bands listed below:

MHz	MHz	MHz	GHz
0.090–0.110-----	16.42–16.423	399.9–410	4.5–5.15
¹ 0.495–0.505-----	16.69475–16.69525	608–614	5.35–5.46
2.1735–2.1905-----	16.80425–16.80475	960–1240	7.25–7.75
4.125–4.128-----	25.5–25.67	1300–1427	8.025–8.5
4.17725–4.17775-----	37.5–38.25	1435–1626.5	9.0–9.2
4.20725–4.20775-----	73–74.6	1645.5–1646.5	9.3–9.5
6.215–6.218-----	74.8–75.2	1660–1710	10.6–12.7
6.26775–6.26825-----	108–121.94	1718.8–1722.2	13.25–13.4
6.31175–6.31225-----	123–138	2200–2300	14.47–14.5
8.291–8.294-----	149.9–150.05	2310–2390	15.35–16.2
8.362–8.366-----	156.52475–156.52525	2483.5–2500	17.7–21.4
8.37625–8.38675-----	156.7–156.9	2655–2900	22.01–23.12
8.41425–8.41475-----	162.0125–167.17	3260–3267	23.6–24.0
12.29–12.293-----	167.72–173.2	3332–3339	31.2–31.8
12.51975–12.52025-----	240–285	3345.8–3358 36.	43–36.5
12.57675–12.57725-----	322–335.4	3600–4400	(²)

Table 9. Restricted Bands of Operation

¹ Until February 1, 1999, this restricted band shall be 0.490 – 0.510 MHz.

² Above 38.6

Test Requirement(s): § 15.209 (a): Except as provided elsewhere in this subpart, the emissions from an intentional radiator shall not exceed the field strength levels specified in Table 10.

Frequency (MHz)	§ 15.209(a), Radiated Emission Limits (dBµV) @ 3m
30 - 88	40.00
88 - 216	43.50
216 - 960	46.00
Above 960	54.00

Table 10. Radiated Emissions Limits Calculated from FCC Part 15, § 15.209 (a)

Test Procedure: The transmitter was set to the low, mid, and high channel at the highest output power and placed on a 0.8 m high wooden table inside in a semi-anechoic chamber. Measurements were performed with the EUT rotated 360 degrees and varying the adjustable antenna mast with 1 m to 4 m height to determine worst case orientation for maximum emissions. Measurements taken above 1GHz were taken with the EUT placed 1.5m high.

For frequencies from 30 MHz to 1 GHz, measurements were made using a quasi-peak detector with a 120 kHz bandwidth. For frequencies above 1GHz, measurements were made using a peak and average detector with 1MHz bandwidth.

For intentional radiators with a digital device portion which operates below 10 GHz, the spectrum was investigated as per §15.33(a)(1) and §15.33(a)(4); i.e., the lowest RF signal generated or used in the device up to the 10th harmonic of the highest fundamental frequency or to 40 GHz, whichever is lower.

In accordance with §15.35(b) the limit on the radio frequency emissions as measured using instrumentation with a peak detector function shall be 20 dB above the maximum permitted average limit for the frequency being investigated unless a different peak emission limit is otherwise specified in the rules.

$$\text{EUT Field Strength Final Amplitude} = \text{Raw Amplitude} - \text{Preamp gain} + \text{Antenna Factor} + \text{Cable Loss} - \text{Distance Correction Factor}$$

Test Results: The EUT was compliant with the Radiated Spurious Emission limits of §15.247(d). Measured emissions were within applicable limits. Emissions above the limit are caused by the intentional radiator and are not subject to the requirements of this section.

Test Engineer(s): Giuliano Messina

Test Date(s): December 26, 2018

Radiated Spurious Emissions Test Results

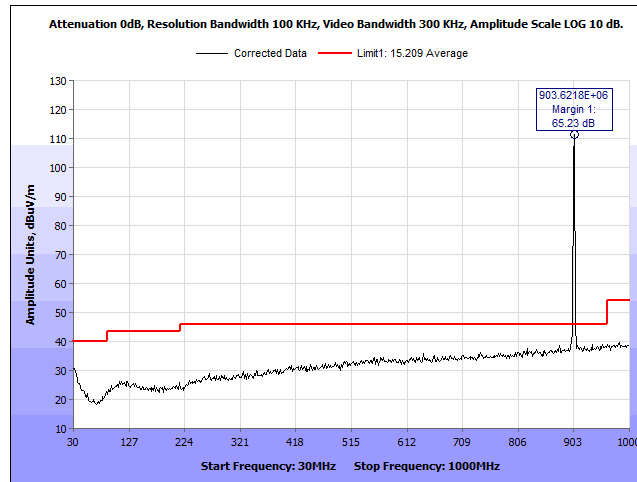

Plot 11. Radiated Spurious Emissions, 902.3 MHz, 30 – 1000 MHz

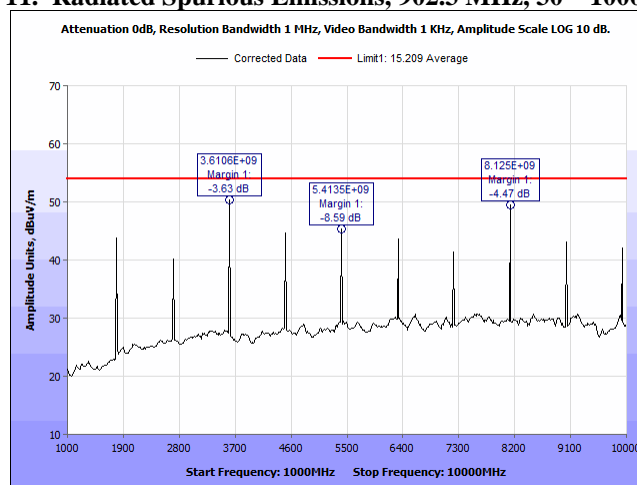

Plot 12. Radiated Spurious Emissions, 902.3 MHz, 1 – 10 GHz, Average

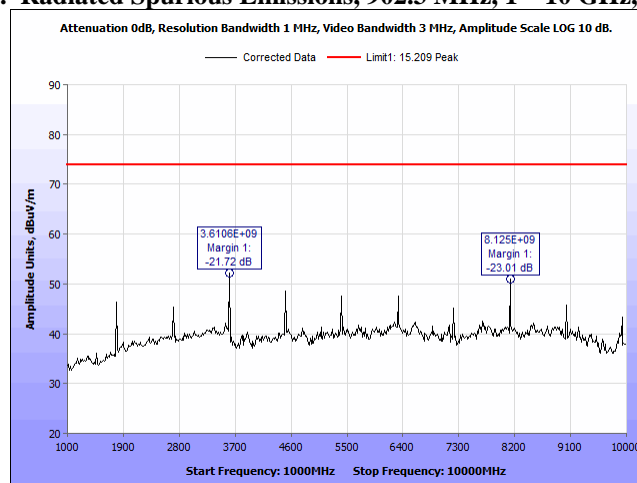

Plot 13. Radiated Spurious Emissions, 902.3 MHz, 1 – 10 GHz, Peak

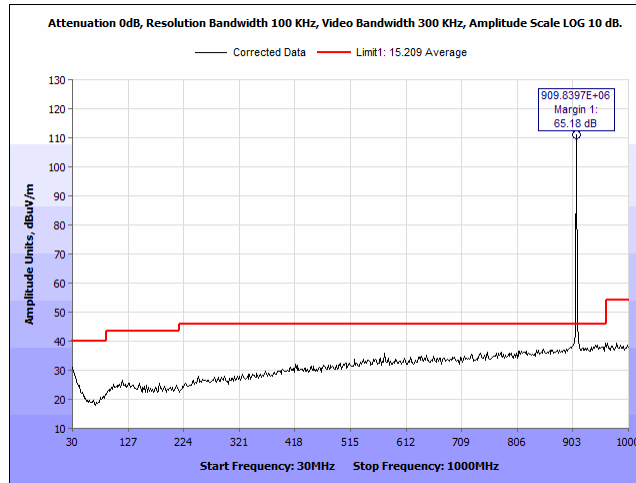

Plot 14. Radiated Spurious Emissions, 908.7 MHz, 30 – 1000 MHz

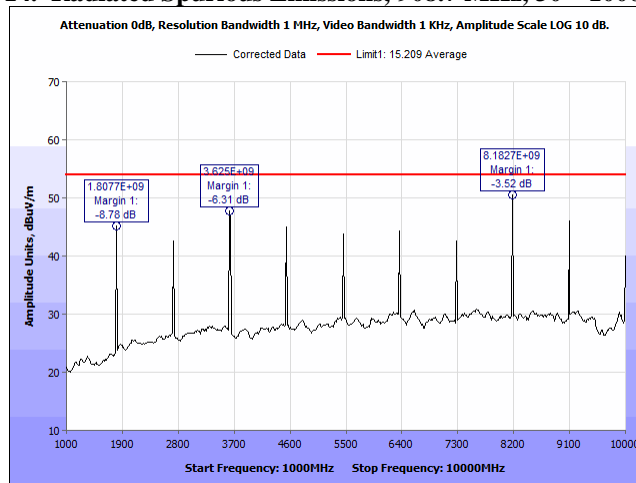

Plot 15. Radiated Spurious Emissions, 908.7 MHz, 1 – 10 GHz, Average

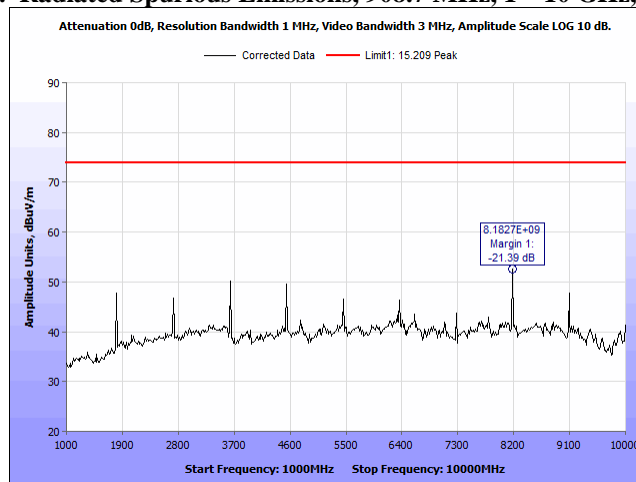

Plot 16. Radiated Spurious Emissions, 908.7 MHz, 1 – 10 GHz, Peak

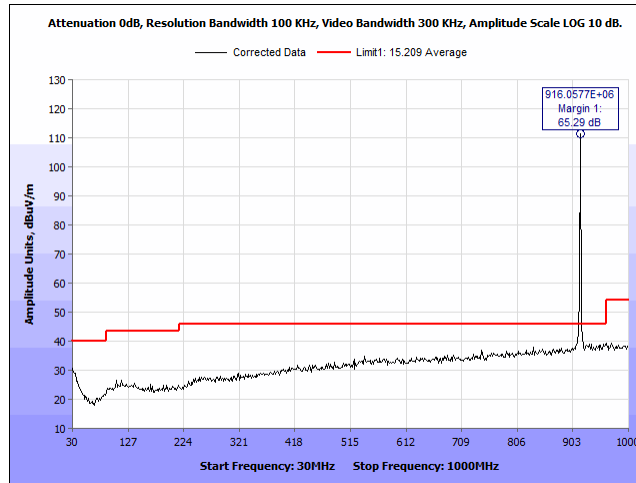

Plot 17. Radiated Spurious Emissions, 914.9 MHz, 30 – 1000 MHz

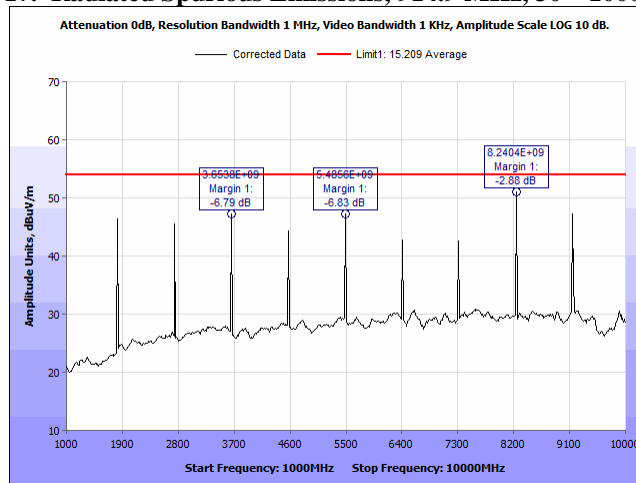

Plot 18. Radiated Spurious Emissions, 914.9 MHz, 1 – 10 GHz, Average

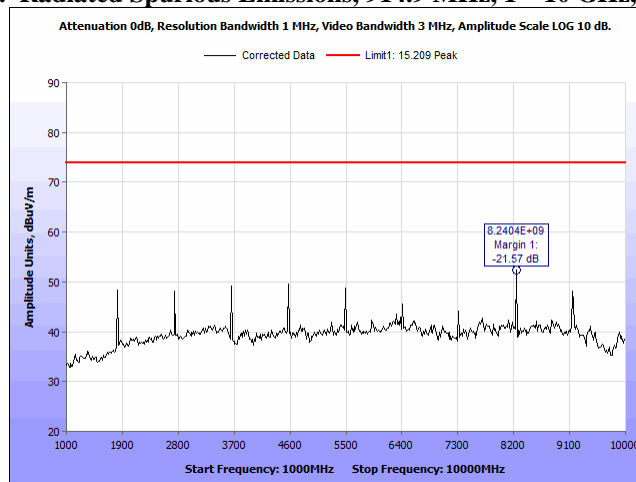

Plot 19. Radiated Spurious Emissions, 914.9 MHz, 1 – 10 GHz, Peak

Radiated Band Edge Measurements

Test Procedures:

The transmitter was maximized. Measurements were performed of the low and high Channels. The EUT was rotated orthogonally through all three axes. Plots shown are corrected for both antenna correction factor and distance.

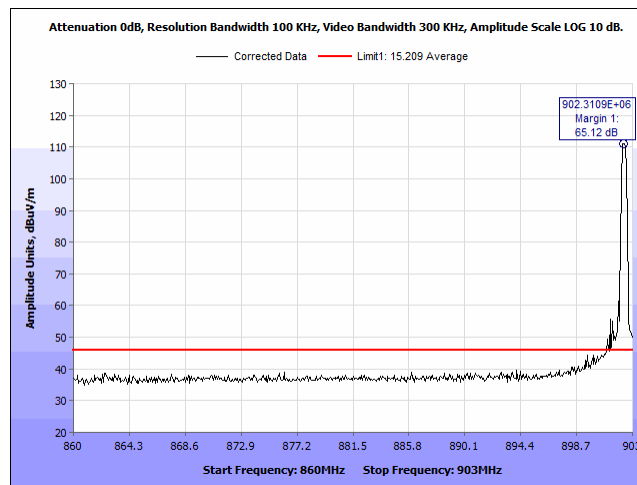

Plot 20. Radiated Restricted Band Edge, 902.3 MHz

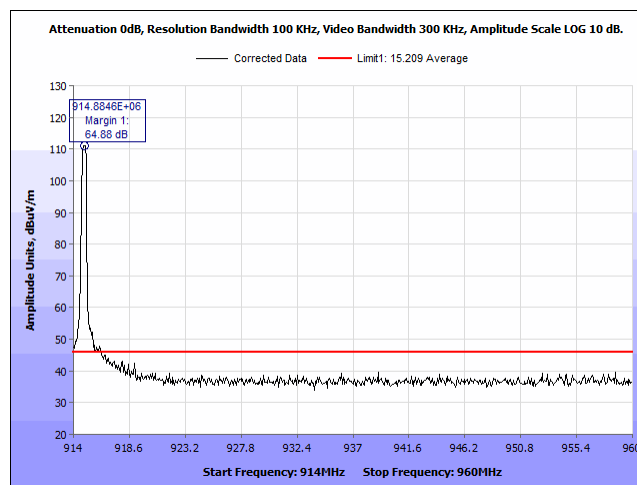

Plot 21. Radiated Restricted Band Edge, 914.9 MHz

Radiated Spurious Emissions Test Setup

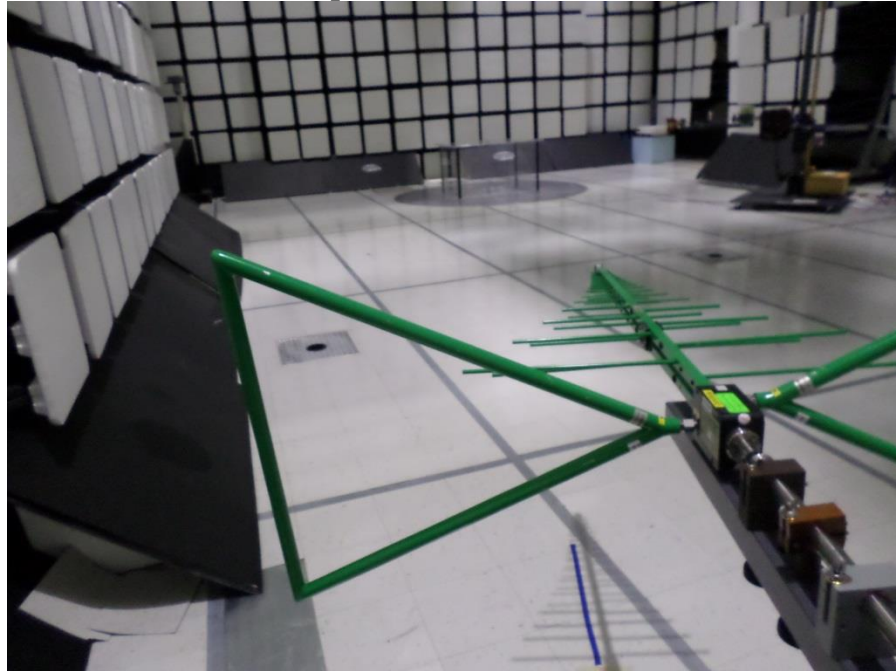

Photograph 1. Radiated Spurious Emissions, Below 1 GHz, Antenna, Test Setup

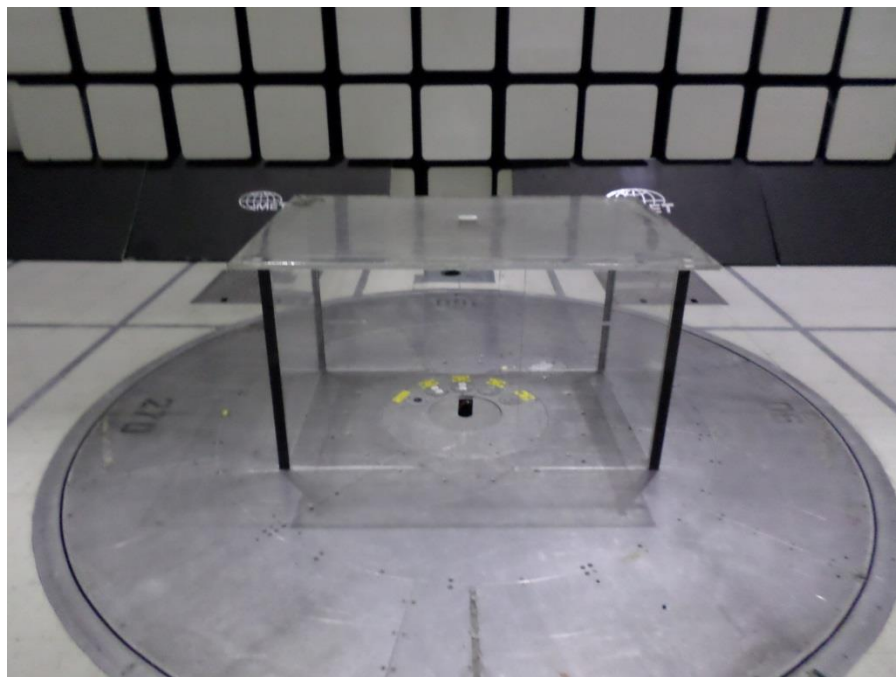

Photograph 2. Radiated Spurious Emissions, Below 1 GHz, Front, Test Setup

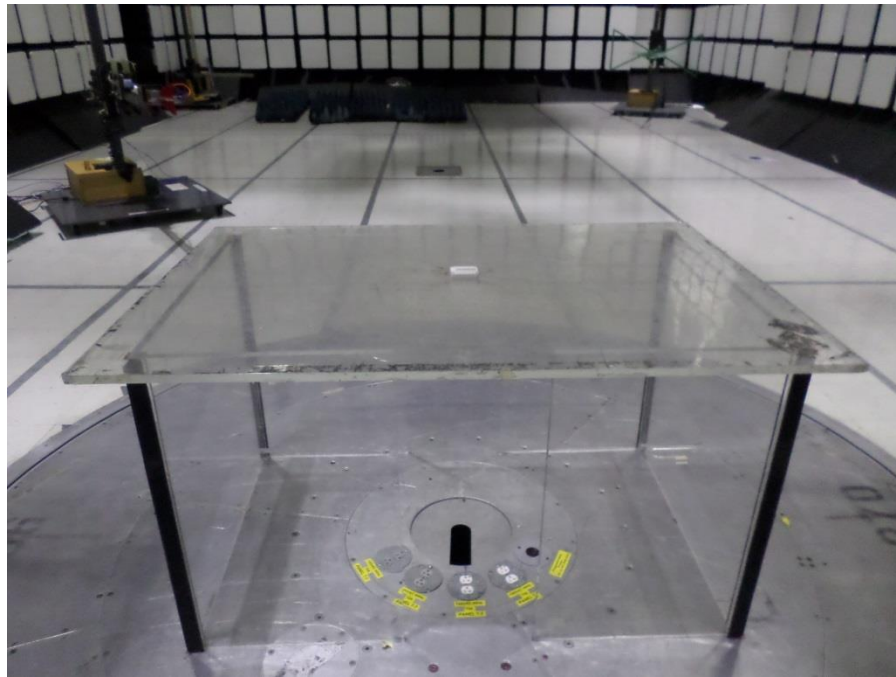

Photograph 3. Radiated Spurious Emissions, Below 1 GHz, Rear, Test Setup

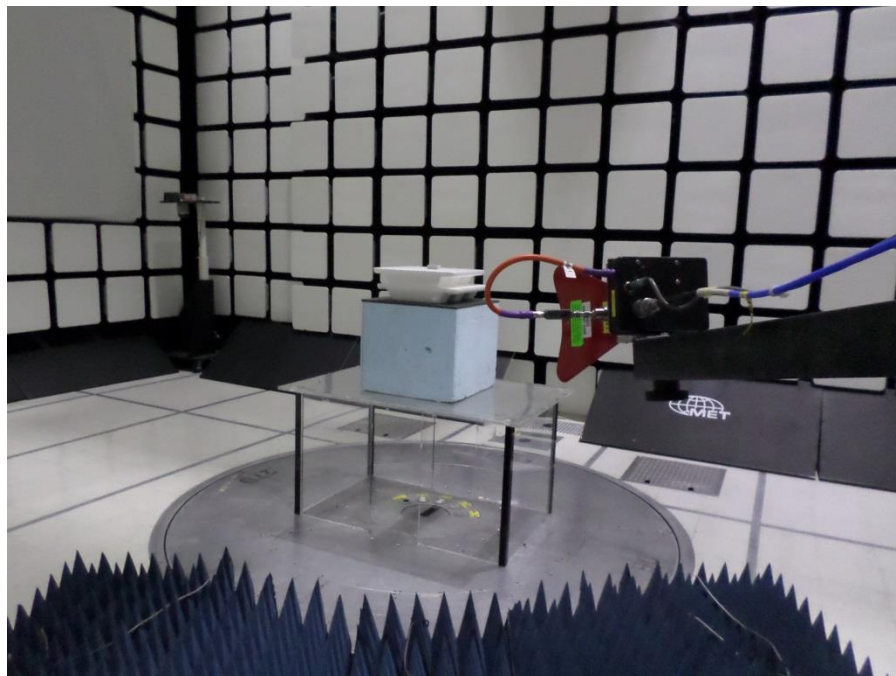

Photograph 4. Radiated Spurious Emissions, Above 1 GHz, Antenna, Test Setup

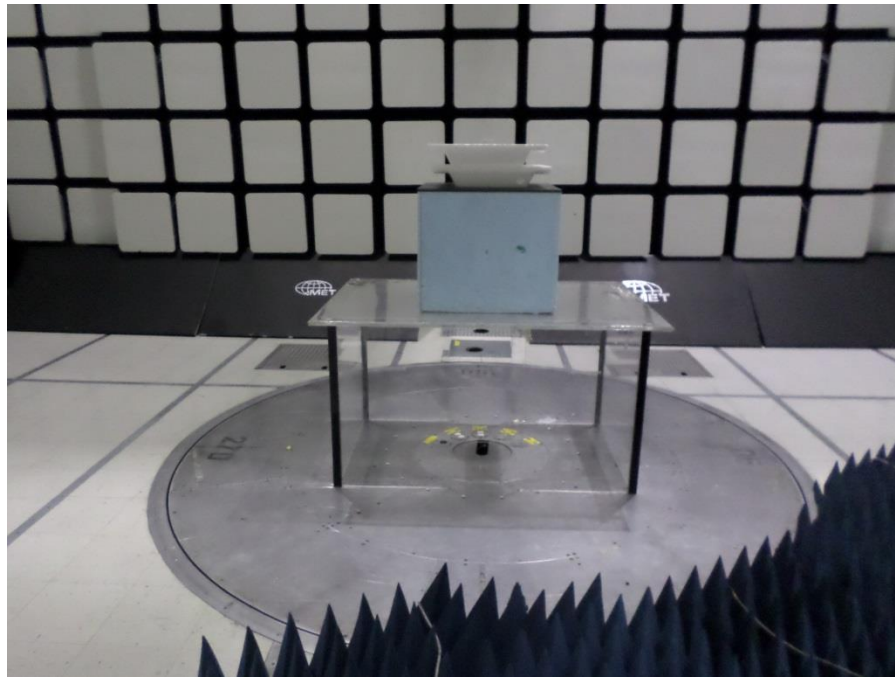

Photograph 5. Radiated Spurious Emissions, Above 1 GHz, Front, Test Setup

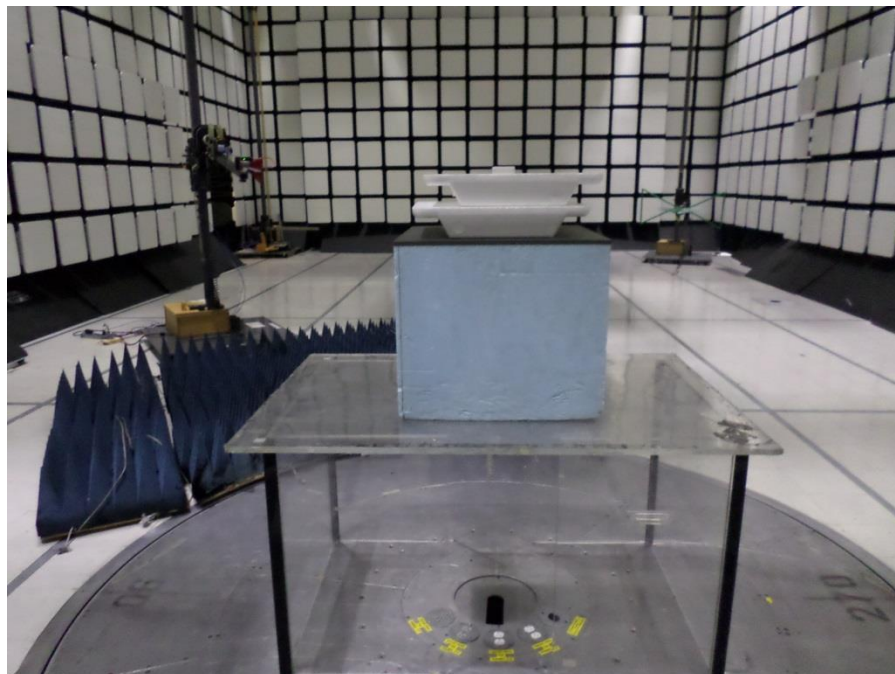

Photograph 6. Radiated Spurious Emissions, Above 1 GHz, Rear, Test Setup

Electromagnetic Compatibility Criteria for Intentional Radiators

§ 15.247(d) RF Conducted Spurious Emissions Requirements and Band Edge

Test Requirement: **15.247(d)** In any 100 kHz bandwidth outside the frequency band in which the spread spectrum or digitally modulated intentional radiator is operating, the radio frequency power that is produced by the intentional radiator shall be at least 20 dB below that in the 100 kHz bandwidth within the band that contains the highest level of the desired power, based on either an RF conducted or a radiated measurement, provided the transmitter demonstrates compliance with the peak conducted power limits. If the transmitter complies with the conducted power limits based on the use of RMS averaging over a time interval, as permitted under paragraph (b)(3) of this section, the attenuation required under this paragraph shall be 30 dB instead of 20 dB.

Test Procedure: For intentional radiators with a digital device portion which operates below 10 GHz, the spectrum was investigated as per §15.33(a)(1) and §15.33(a)(4); i.e., the lowest RF signal generated or used in the device up to the 10th harmonic of the highest fundamental frequency or to 40 GHz, whichever is lower.

See following pages for detailed test results with RF Conducted Spurious Emissions.

Test Results: The EUT was compliant with the Conducted Spurious Emission limits of §15.247(d). Measured emissions were within applicable limits.

Test Engineer(s): Giuliano Messina

Test Date(s): December 27, 2018

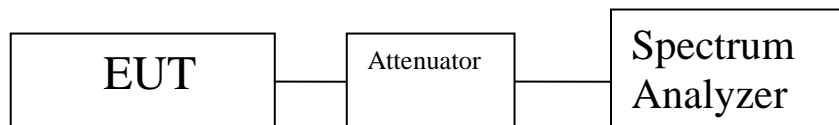
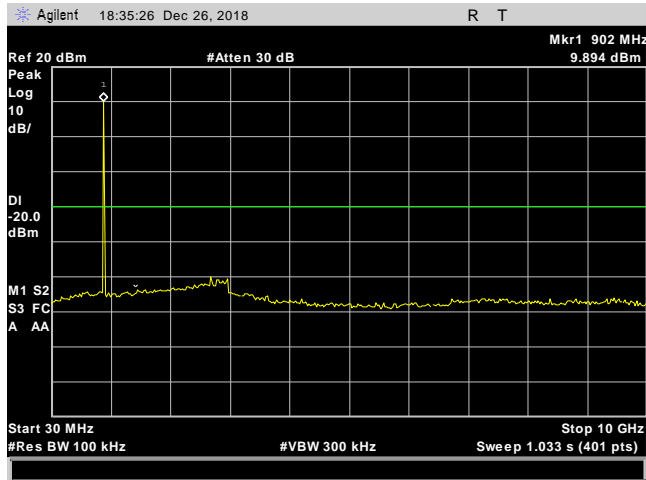
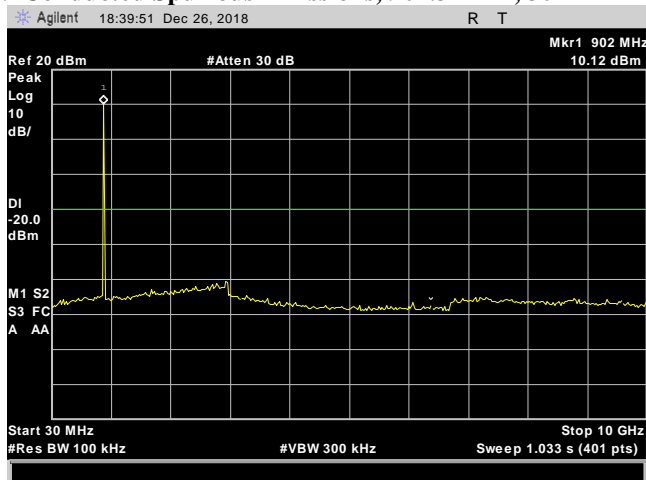

Figure 5. Block Diagram, Conducted Spurious Emissions Test Setup

Conducted Spurious Emissions Test Results



Plot 22. Conducted Spurious Emissions, 902.3 MHz, 30 MHz – 10 GHz



Plot 23. Conducted Spurious Emissions, 908.7 MHz, 30 MHz – 10 GHz

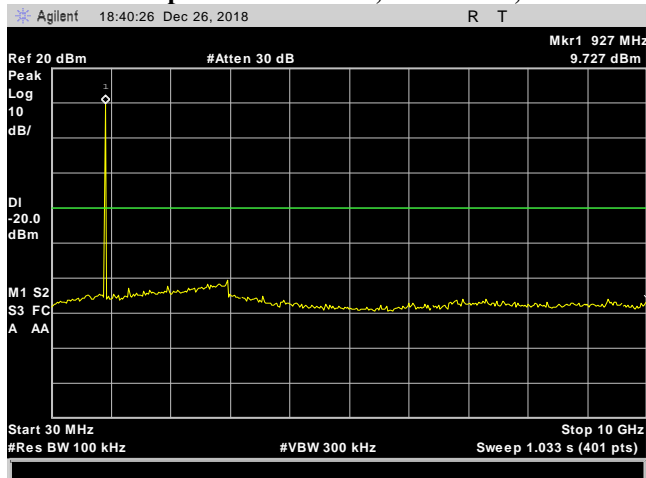

Plot 24. Conducted Spurious Emissions, 914.9 MHz, 30 MHz – 10 GHz

Conducted Band Edge Test Results

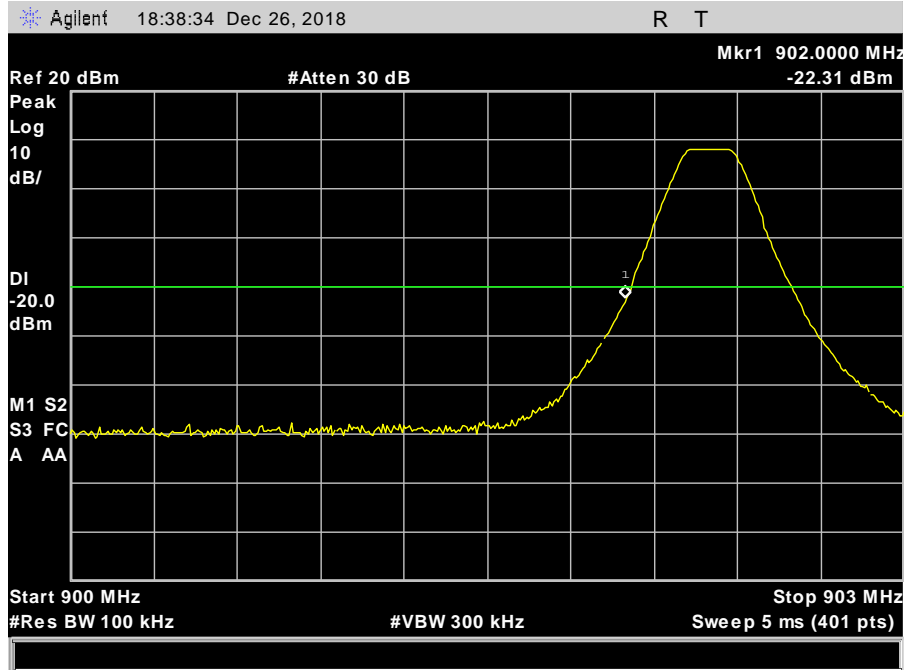

Plot 25. Conducted Band Edge, 902.3 MHz

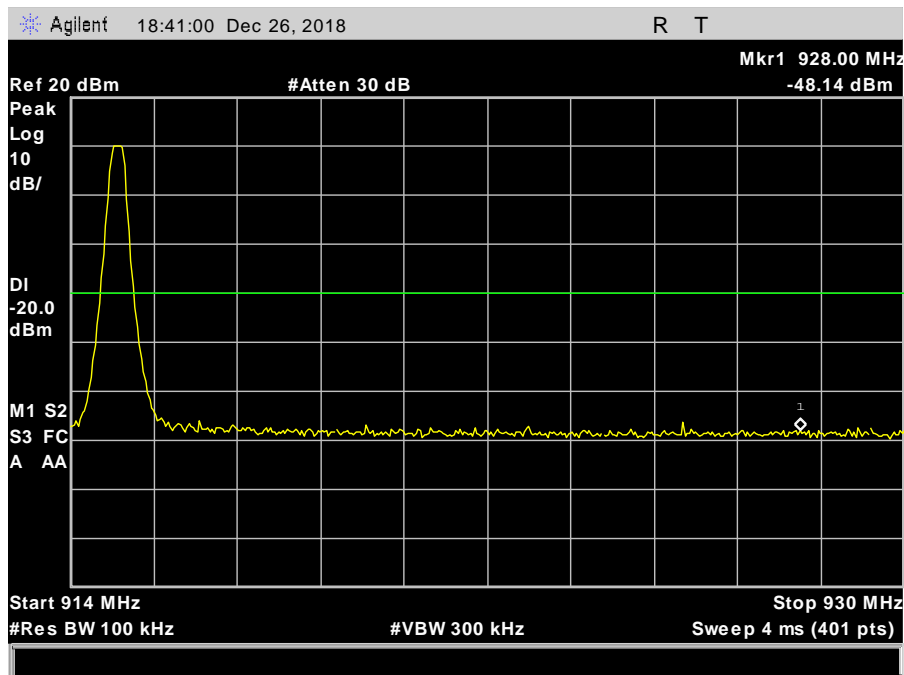

Plot 26. Conducted Band Edge, 914.9 MHz

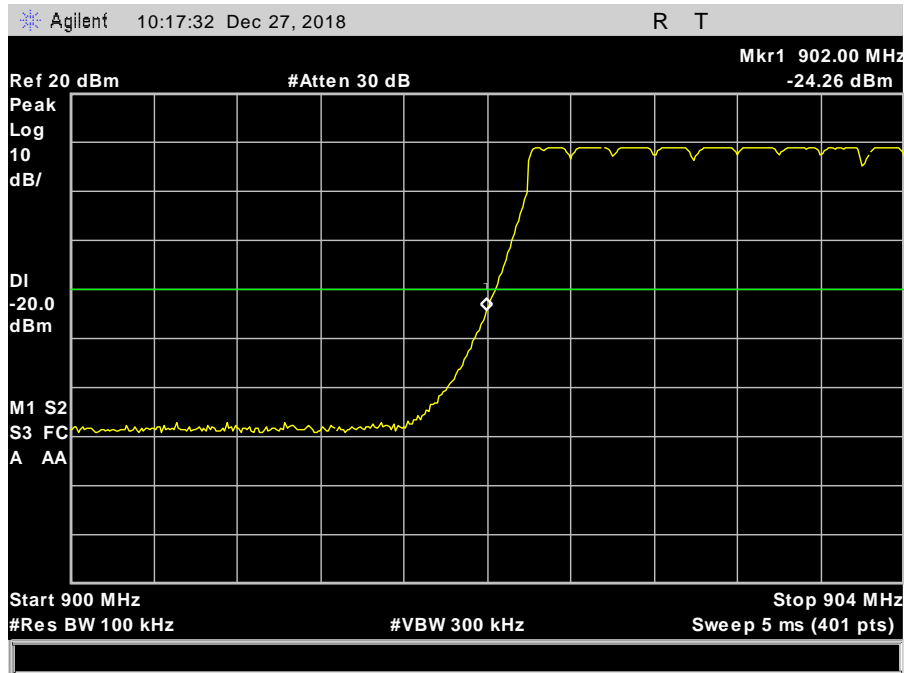

Plot 27. Conducted Band Edge, Hopping, Low

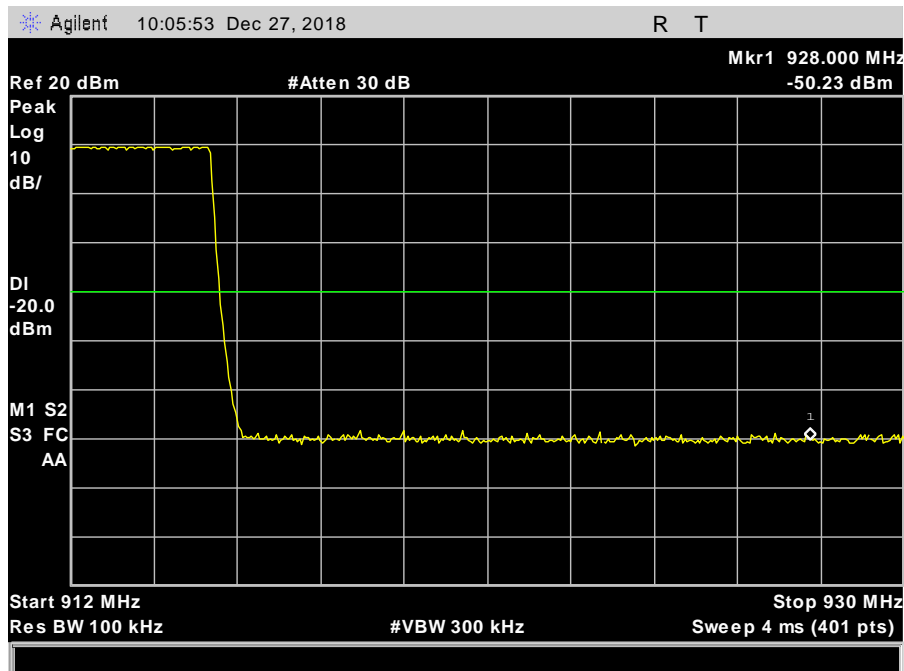

Plot 28. Conducted Band Edge, Hopping, High

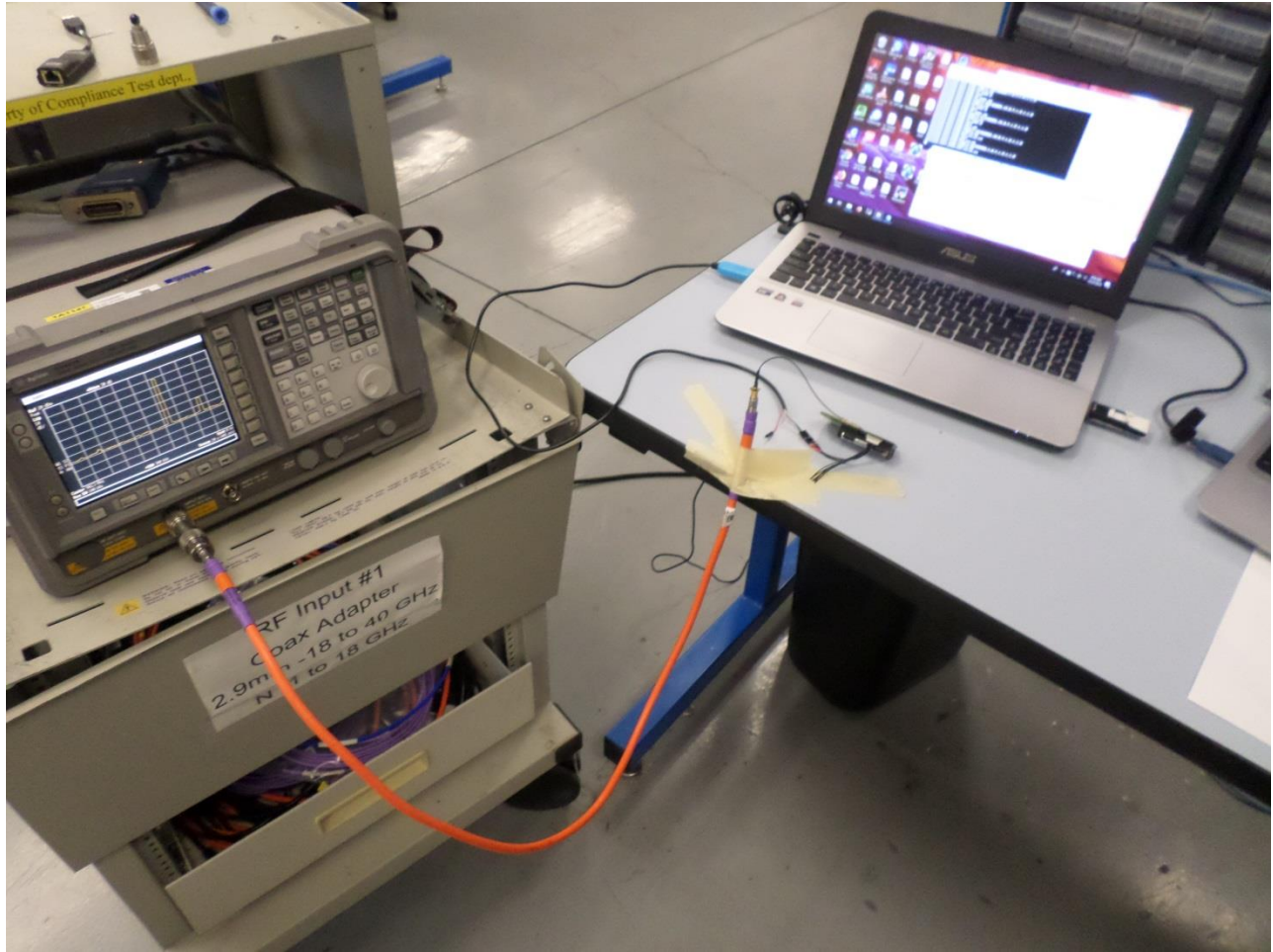

Photograph 7. Conducted Spurious Emissions, Test Setup

Electromagnetic Compatibility Criteria for Intentional Radiators
§ 15.247(g)(h) Declaration Statements for FHSS

The Longview Asset Tracker: model: CR123 is a wireless tag which operates using LoRa modulation in the North American ISM band of 902 MHz – 928 MHz with TDD operation across the entire band. LoRa is a long range, low power wireless standard for Internet of Things (IoT) application (<https://www.lora-alliance.org/>). The Asset Tracker: model: CR123 and its LoRa protocol is designed to be compliant with FCC Part 15.247 as a frequency hopping spreads spectrum (FHSS) System. The device has a transmitter capable of approximately +14 dBm maximum for the fixed Asset Tracker: model: CR123 (conducted at the antenna).

Electromagnetic Compatibility Criteria for Intentional Radiators

§ 15.247(i) Maximum Permissible Exposure

RF Exposure Requirements: §1.1307(b)(1) and §1.1307(b)(2): Systems operating under the provisions of this section shall be operated in a manner that ensures that the public is not exposed to radio frequency energy levels in excess of the Commission’s guidelines.

RF Radiation Exposure Limit: §1.1310: As specified in this section, the Maximum Permissible Exposure (MPE) Limit shall be used to evaluate the environmental impact of human exposure to radiofrequency (RF) radiation as specified in Sec. 1.1307(b), except in the case of portable devices which shall be evaluated according to the provisions of Sec. 2.1093 of this chapter.

Limit for Uncontrolled exposure: 0.61 mW/cm²

EUT maximum antenna gain = 18 dBi.

Equation from page 18 of OET 65, Edition 97-01

$$S = PG / 4\pi R^2 \quad \text{or} \quad R = \sqrt{PG / 4\pi S}$$

where, S = Power Density
R = Distance (20 cm)
P = Power Input to antenna (14.388 mW)
G = Antenna Gain (1.585 numeric)

$$S = (14.388 * 1.585) / (4\pi(20)^2) = 0.00454$$

FCC									
Frequency (MHz)	Con. Pwr. (dBm)	Con. Pwr. (mW)	Ant. Gain (dBi)	Ant. Gain numeric	Pwr. Density (mW/cm ²)	Limit (mW/cm ²)	Margin	Distance (cm)	Result
914.9	11.58	14.388	2	1.585	0.00454	0.61	0.605	20	Pass

Table 11. Maximum Permissible Exposure, Test Results

IV. Test Equipment

Test Equipment

Calibrated test equipment utilized during testing was maintained in a current state of calibration per the requirements of ISO/IEC 17025:2005.

MET Asset #	Nomenclature	Manufacturer	Model	Last Cal Date	Cal Due Date
1A1184	Spectrum Analyzer	Agilent	E4407B	4/20/2018	4/20/2019
1A1083	EMI Test Receiver	Rohde & Schwarz	ESU40	10/17/2018	10/17/2019
1A1106	10m Chamber (FCC)	ETS	Semi-Anechoic	See Note	
1A1050	Bilog Antenna (30MHz to 1GHz)	Schaffner	CBL 6112D	8/29/2018	2/29/2020
1A1050-A	Attenuator	Fairview Microwave	SA6N5WA-04	8/29/2018	2/29/2020
1A1047	Horn Antenna	ETS	3117	10/30/2018	4/30/2020
1A1099	Generator	COM-Power Corp	CGO-51000	See Note	
1A1088	Pre-Amp	Rohde & Schwarz	TS-PR1	See Note	
1A1044	Generator	COM-Power Corp	CG-520	See Note	
1A1073	Multi Device Controller	ETS EMCO	2090	See Note	
1A1074	System Controller	Panasonic	WV-CU101	See Note	
1A1080	Multi Device Controller	ETS EMCO	2090	See Note	
1A1180	Pre-Amp	Miteq	AMF-7D-01001800-22-10P	See Note	

Table 12. Test Equipment List

Note: Functionally tested equipment is verified using calibrated instrumentation at the time of testing.

V. Certification & User's Manual Information

Certification & User's Manual Information

A. Certification Information

The following is extracted from Title 47 of the Code of Federal Regulations, Part 2, Subpart I — Marketing of Radio frequency devices:

§ 2.801 Radio-frequency device defined.

As used in this part, a radio-frequency device is any device which in its operation is capable of Emitting radio-frequency energy by radiation, conduction, or other means. Radio- frequency devices include, but are not limited to:

- (a) The various types of radio communication transmitting devices described throughout this chapter.
- (b) *The incidental, unintentional and intentional radiators defined in Part 15 of this chapter.*
- (c) The industrial, scientific, and medical equipment described in Part 18 of this chapter.
- (d) Any part or component thereof which in use emits radio-frequency energy by radiation, conduction, or other means.

§ 2.803 Marketing of radio frequency devices prior to equipment authorization.

- (a) Except as provided elsewhere in this chapter, no person shall sell or lease, or offer for sale or lease (including advertising for sale or lease), or import, ship or distribute for the purpose of selling or leasing or offering for sale or lease, any radio frequency device unless:
 - (1) In the case of a device subject to certification, such device has been authorized by the Commission in accordance with the rules in this chapter and is properly identified and labeled as required by §2.925 and other relevant sections in this chapter; or
 - (2) In the case of a device that is not required to have a grant of equipment authorization issued by the Commission, but which must comply with the specified technical standards prior to use, such device also complies with all applicable administrative (including verification of the equipment or authorization under a Declaration of Conformity, where required), technical, labeling and identification requirements specified in this chapter.
- (d) Notwithstanding the provisions of paragraph (a) of this section, the offer for sale solely to business, commercial, industrial, scientific or medical users (but not an offer for sale to other parties or to end users located in a residential environment) of a radio frequency device that is in the conceptual, developmental, design or pre-production stage is permitted prior to equipment authorization or, for devices not subject to the equipment authorization requirements, prior to a determination of compliance with the applicable technical requirements *provided* that the prospective buyer is advised in writing at the time of the offer for sale that the equipment is subject to the FCC rules and that the equipment will comply with the appropriate rules before delivery to the buyer or to centers of distribution.

- (e)(1) Notwithstanding the provisions of paragraph (a) of this section, prior to equipment authorization or determination of compliance with the applicable technical requirements any radio frequency device may be operated, but not marketed, for the following purposes and under the following conditions:
- (i) *Compliance testing*;
 - (ii) Demonstrations at a trade show provided the notice contained in paragraph (c) of this section is displayed in a conspicuous location on, or immediately adjacent to, the device;
 - (iii) Demonstrations at an exhibition conducted at a business, commercial, industrial, scientific or medical location, but excluding locations in a residential environment, provided the notice contained in paragraphs (c) or (d) of this section, as appropriate, is displayed in a conspicuous location on, or immediately adjacent to, the device;
 - (iv) Evaluation of product performance and determination of customer acceptability, provided such operation takes place at the manufacturer's facilities during developmental, design or pre-production states; or
 - (v) Evaluation of product performance and determination of customer acceptability where customer acceptability of a radio frequency device cannot be determined at the manufacturer's facilities because of size or unique capability of the device, provided the device is operated at a business, commercial, industrial, scientific or medical user's site, but not at a residential site, during the development, design or pre-production stages.
- (e)(2) For the purpose of paragraphs (e)(1)(iv) and (e)(1)(v) of this section, the term *manufacturer's facilities* includes the facilities of the party responsible for compliance with the regulations and the manufacturer's premises, as well as the facilities of other entities working under the authorization of the responsible party in connection with the development and manufacture, but not the marketing, of the equipment.
- (f) For radio frequency devices subject to verification and sold solely to business, commercial, industrial, scientific and medical users (excluding products sold to other parties or for operation in a residential environment), parties responsible for verification of the devices shall have the option of ensuring compliance with the applicable technical specifications of this chapter at each end user's location after installation, provided that the purchase or lease agreement includes a proviso that such a determination of compliance be made and is the responsibility of the party responsible for verification of the equipment.

Certification & User's Manual Information

The following is extracted from Title 47 of the Code of Federal Regulations, Part 2, Subpart J — Equipment Authorization Procedures:

§ 2.901 Basis and Purpose

- (a) In order to carry out its responsibilities under the Communications Act and the various treaties and international regulations, and in order to promote efficient use of the radio spectrum, the Commission has developed technical standards for radio frequency equipment and parts or components thereof. The technical standards applicable to individual types of equipment are found in that part of the rules governing the service wherein the equipment is to be operated.¹ *In addition to the technical standards provided, the rules governing the service may require that such equipment be verified by the manufacturer or importer, be authorized under a Declaration of Conformity, or receive an equipment authorization from the Commission by one of the following procedures: certification or registration.*
- (b) The following sections describe the verification procedure, the procedure for a Declaration of Conformity, and the procedures to be followed in obtaining certification from the Commission and the conditions attendant to such a grant.

§ 2.907 Certification.

- (a) Certification is an equipment authorization issued by the Commission, based on representation and test data submitted by the applicant.
- (b) Certification attaches to all units subsequently marketed by the grantee which are identical (see Section 2.908) to the sample tested except for permissive changes or other variations authorized by the Commission pursuant to Section 2.1043.

¹ In this case, the equipment is subject to the rules of Part 15. More specifically, the equipment falls under Subpart B (of Part 15), which deals with unintentional radiators.

Certification & User's Manual Information

§ 2.948 Description of measurement facilities.

- (a) Each party making measurements of equipment that is subject to an equipment authorization under Part 15 or Part 18 of this chapter, regardless of whether the measurements are filed with the Commission or kept on file by the party responsible for compliance of equipment marketed within the U.S. or its possessions, shall compile a description of the measurement facilities employed.
- (1) If the measured equipment is subject to the verification procedure, the description of the measurement facilities shall be retained by the party responsible for verification of the equipment.
- (i) *If the equipment is verified through measurements performed by an independent laboratory, it is acceptable for the party responsible for verification of the equipment to rely upon the description of the measurement facilities retained by or placed on file with the Commission by that laboratory. In this situation, the party responsible for the verification of the equipment is not required to retain a duplicate copy of the description of the measurement facilities.*
- (ii) If the equipment is verified based on measurements performed at the installation site of the equipment, no specific site calibration data is required. It is acceptable to retain the description of the measurement facilities at the site at which the measurements were performed.
- (2) If the equipment is to be authorized by the Commission under the certification procedure, the description of the measurement facilities shall be filed with the Commission's Laboratory in Columbia, Maryland. The data describing the measurement facilities need only be filed once but must be updated as changes are made to the measurement facilities or as otherwise described in this section. At least every three years, the organization responsible for filing the data with the Commission shall certify that the data on file is current.

Certification & User's Manual Information

1. Label and User's Manual Information

The following is extracted from Title 47 of the Code of Federal Regulations, Part 15, Subpart A — General:

§ 15.19 Labeling requirements.

(a) *In addition to the requirements in Part 2 of this chapter, a device subject to certification or verification shall be labeled as follows:*

- (1) Receivers associated with the operation of a licensed radio service, e.g., FM broadcast under Part 73 of this chapter, land mobile operation under Part 90, etc., shall bear the following statement in a conspicuous location on the device:

This device complies with Part 15 of the FCC Rules. Operation is subject to the condition that this device does not cause harmful interference.

- (2) A stand-alone cable input selector switch, shall bear the following statement in a conspicuous location on the device:

This device is verified to comply with Part 15 of the FCC Rules for use with cable television service.

- (3) All other devices shall bear the following statement in a conspicuous location on the device:

This device complies with Part 15 of the FCC Rules. Operation is subject to the following two conditions: (1) This device may not cause harmful interference, and (2) this device must accept any interference received, including interference that may cause undesired operation.

- (4) Where a device is constructed in two or more sections connected by wires and marketed together, the statement specified under paragraph (a) of this section is required to be affixed only to the main control unit.

- (5) When the device is so small or for such use that it is not practicable to place the statement specified under paragraph (a) of this section on it, the information required by this paragraph shall be placed in a prominent location in the instruction manual or pamphlet supplied to the user or, alternatively, shall be placed on the container in which the device is marketed. However, the FCC identifier or the unique identifier, as appropriate, must be displayed on the device.

§ 15.21 Information to user.

The users manual or instruction manual for an intentional or unintentional radiator shall caution the user that changes or modifications not expressly approved by the party responsible for compliance could void the user's authority to operate the equipment.

Verification & User's Manual Information

The following is extracted from Title 47 of the Code of Federal Regulations, Part 15, Subpart B — Unintentional Radiators:

§ 15.105 Information to the user.

- (a) For a Class A digital device or peripheral, the instructions furnished the user shall include the following or similar statement, placed in a prominent location in the text of the manual:

Note: This equipment has been tested and found to comply with the limits for a Class A digital device, pursuant to Part 15 of the FCC Rules. These limits are designed to provide reasonable protection against harmful interference when the equipment is operated in a commercial environment. This equipment generates, uses, and can radiate radio frequency energy and, if not installed and used in accordance with the instruction manual, may cause harmful interference to radio communications. Operation of this equipment in a residential area is likely to cause harmful interference in which case the user will be required to correct the interference at own expense.

- (b) For a Class B digital device or peripheral, the instructions furnished the user shall include the following or similar statement, placed in a prominent location in the text of the manual:

Note: This equipment has been tested and found to comply with the limits for a Class B digital device, pursuant to Part 15 of the FCC Rules. These limits are designed to provide reasonable protection against harmful interference when the equipment is operated in a residential environment. This equipment generates, uses, and can radiate radio frequency energy and, if not installed and used in accordance with the instruction manual, may cause harmful interference to radio communications. However, there is no guarantee that interference will not occur in a particular installation. If this equipment does cause harmful interference to radio or television reception, which can be determined by turning the equipment off and on, the user is encouraged to try to correct the interference by one or more of the following measures:

- Reorient or relocate the receiving antenna.
- Increase the separation between the equipment and receiver.
- Connect the equipment into an outlet on a circuit different from that to which the receiver is connected.
- Consult the dealer or an experienced radio/TV technician for help.

End of Report