

APPLICATION CERTIFICATION

On Behalf of

Mr. Bar-B-Q Products LLC

Wireless BBQ thermometer

Model No.: 40128, 40128Y, 40128BY

FCC ID: 2ARI9-40128

Prepared for : Mr. Bar-B-Q Products LLC
Address : 12/F, 1208 Mirror Tower, 61 Mody Road, Tsim Sha Tsui
East, Kowloon, Hong Kong

Prepared by : Shenzhen Accurate Technology Co., Ltd.
Address : 1/F., Building A, Changyuan New Material Port, Science
& Industry Park, Nanshan District, Shenzhen, Guangdong,
P.R. China

Tel: (0755) 26503290
Fax: (0755) 26503396

Report Number : ATE20181506
Date of Test : Sep. 10, 2018--Sep. 26, 2018
Date of Report : Sep. 27, 2018

TABLE OF CONTENTS

Description	Page
Test Report Certification	
1. GENERAL INFORMATION	4
1.1. Description of Device (EUT).....	4
1.2. Accessory and Auxiliary Equipment	4
1.3. Model difference declaration	4
1.4. Description of Test Facility	5
1.5. Measurement Uncertainty	5
2. MEASURING DEVICE AND TEST EQUIPMENT	6
3. SUMMARY OF TEST RESULTS.....	7
4. THE FIELD STRENGTH OF RADIATION EMISSION	8
4.1. Block Diagram of Test Setup.....	8
4.2. The Field Strength of Radiation Emission Measurement Limits.....	10
4.3. Configuration of EUT on Measurement	10
4.4. Operating Condition of EUT	10
4.5. Test Procedure	11
4.6. Data Sample.....	11
4.7. The Field Strength of Radiation Emission Measurement Results	12
5. 20DB OCCUPIED BANDWIDTH	13
5.1. Block Diagram of Test Setup.....	13
5.2. The Bandwidth of Emission Limit According To FCC Part 15 Section 15.231(c).....	13
5.3. EUT Configuration on Measurement	13
5.4. Operating Condition of EUT	13
5.5. Test Procedure	13
5.6. Measurement Result	14
6. RELEASE TIME MEASUREMENT.....	15
6.1. Block Diagram of Test Setup.....	15
6.2. Release Time Measurement According To FCC Part 15 Section 15.231(e)	15
6.3. EUT Configuration on Measurement	15
6.4. Operating Condition of EUT	15
6.5. Test Procedure	15
6.6. Measurement Result	16
7. AVERAGE FACTOR MEASUREMENT	17
7.1. Block Diagram of Test Setup.....	17
7.2. Average factor Measurement according to ANSI C63.10-2013.....	17
7.3. EUT Configuration on Measurement	17
7.4. Operating Condition of EUT	17
7.5. Test Procedure	18
7.6. Measurement Result	18
8. ANTENNA REQUIREMENT.....	19
8.1. The Requirement	19
8.2. Antenna Construction	19

Test Report Certification

Applicant& address : Mr. Bar-B-Q Products LLC
12/F, 1208 Mirror Tower, 61 Mody Road, Tsim Sha Tsui East,
Kowloon, Hong Kong
Manufacturer& address : Mr. Bar-B-Q Products LLC
12/F, 1208 Mirror Tower, 61 Mody Road, Tsim Sha Tsui East,
Kowloon, Hong Kong
Product : Wireless BBQ thermometer
Model No. : 40128, 40128Y, 40128BY
Trade name : n.a

Measurement Procedure Used:

**FCC Rules and Regulations Part 15 Subpart C Section 15.231(e)
ANSI C63.10: 2013**

The device described above is tested by SHENZHEN ACCURATE TECHNOLOGY CO., LTD to determine the maximum emission levels emanating from the device. The maximum emission levels are compared to the FCC Part 15 Subpart C Section 15.231(e). The measurement results are contained in this test report and SHENZHEN ACCURATE TECHNOLOGY CO., LTD is assumed full responsibility for the accuracy and completeness of these measurements. Also, this report shows that the Equipment Under Test (EUT) is to be technically compliant with the FCC requirements.

This report applies to above tested sample only. This report shall not be reproduced in part without written approval of SHENZHEN ACCURATE TECHNOLOGY CO., LTD.

Date of Test : Sep. 10, 2018--Sep. 26, 2018
Date of Report: Sep. 27, 2018

Prepared by :

(Tin Wang, Engineer)

Approved &
Authorized Signer :

(Sean Liu, Manager)

1. GENERAL INFORMATION

1.1. Description of Device (EUT)

EUT	:	Wireless BBQ thermometer
Model Number	:	40128, 40128Y, 40128BY
Power Supply	:	DC 3V (Powered by battery)
Modulation:	:	FSK
Operation Frequency	:	433.92MHz
Antenna type	:	Wire Antenna
Antenna gain(max)	:	0dBi
Applicant	:	Mr. Bar-B-Q Products LLC
Address	:	12/F, 1208 Mirror Tower, 61 Mody Road, Tsim Sha Tsui East, Kowloon, Hong Kong
Manufacturer	:	Mr. Bar-B-Q Products LLC
Address	:	12/F, 1208 Mirror Tower, 61 Mody Road, Tsim Sha Tsui East, Kowloon, Hong Kong
Date of sample received	:	Aug. 10, 2018
Date of Test	:	Sep. 10, 2018--Sep. 26, 2018

1.2. Accessory and Auxiliary Equipment

N/A

1.3. Model difference declaration

40128, 40128Y, 40128BY were identical inside, the electrical circuit design, layout, components used and internal wiring, with only difference being model name for different customers.

1.4. Description of Test Facility

EMC Lab	:	Recognition of accreditation by Federal Communications Commission (FCC) The Designation Number is CN1189 The Registration Number is 708358
		Listed by Innovation, Science and Economic Development Canada (ISED) The Registration Number is 5077A-2
		Accredited by China National Accreditation Service for Conformity Assessment (CNAS) The Registration Number is CNAS L3193
		Accredited by American Association for Laboratory Accreditation (A2LA) The Certificate Number is 4297.01
Name of Firm	:	Shenzhen Accurate Technology Co., Ltd.
Site Location	:	1/F., Building A, Changyuan New Material Port, Science & Industry Park, Nanshan District, Shenzhen, Guangdong, P.R. China

1.5. Measurement Uncertainty

Conducted Emission Expanded Uncertainty	=	2.23dB, k=2
Radiated emission expanded uncertainty (9kHz-30MHz)	=	3.08dB, k=2
Radiated emission expanded uncertainty (30MHz-1000MHz)	=	4.42dB, k=2
Radiated emission expanded uncertainty (Above 1GHz)	=	4.06dB, k=2

2. MEASURING DEVICE AND TEST EQUIPMENT

Table 1: List of Test and Measurement Equipment

Kind of equipment	Manufacturer	Type	S/N	Calibrated dates	Calibrated until
EMI Test Receiver	Rohde&Schwarz	ESCS30	100307	Jan. 06, 2018	Jan. 05, 2019
EMI Test Receiver	Rohde&Schwarz	ESPI3	101526/003	Jan. 06, 2018	Jan. 05, 2019
Spectrum Analyzer	Rohde&Schwarz	FSV-40	101495	Jan. 06, 2018	Jan. 05, 2019
Spectrum Analyzer	Agilent	E7405A	MY45115511	Jan. 06, 2018	Jan. 05, 2019
Pre-Amplifier	Rohde&Schwarz	CBLU118354 0-01	3791	Jan. 06, 2018	Jan. 05, 2019
Loop Antenna	Schwarzbeck	FMZB1516	1516131	Jan. 06, 2018	Jan. 05, 2019
Bilog Antenna	Schwarzbeck	VULB9163	9163-323	Jan. 06, 2018	Jan. 05, 2019
Horn Antenna	Schwarzbeck	BBHA9120D	9120D-655	Jan. 06, 2018	Jan. 05, 2019
Horn Antenna	Schwarzbeck	BBHA9170	9170-359	Jan. 06, 2018	Jan. 05, 2019
Open Switch and Control Unit	Rohde&Schwarz	OSP120 + OSP-B157	101244 + 100866	Jan. 06, 2018	Jan. 05, 2019
LISN	Rohde&Schwarz	ESH3-Z5	100305	Jan. 06, 2018	Jan. 05, 2019
LISN	Schwarzbeck	NSLK8126	8126431	Jan. 06, 2018	Jan. 05, 2019
Highpass Filter	Wainwright Instruments	WHKX3.6/18 G-10SS	N/A	Jan. 06, 2018	Jan. 05, 2019
Band Reject Filter	Wainwright Instruments	WRCG2400/2 485-2375/2510 -60/11SS	N/A	Jan. 06, 2018	Jan. 05, 2019

3. SUMMARY OF TEST RESULTS

FCC Rules	Description of Test	Result
Section 15.207	Conducted Emission	N/A
Section 15.231(e)	Radiated Emission	Compliant
Section 15.231(c)	20dB Bandwidth	Compliant
Section 15.231(e)	Release Time Measurement	Compliant
Section 15.203	Antenna Requirement	Compliant

The product is a automatic operated Wireless BBQ thermometer.

Note: The power supply mode of the EUT is DC 3V, According to the FCC standard requirements, conducted emission is not applicable.

4. THE FIELD STRENGTH OF RADIATION EMISSION

4.1. Block Diagram of Test Setup

4.1.1. Block diagram of connection between the EUT and peripherals

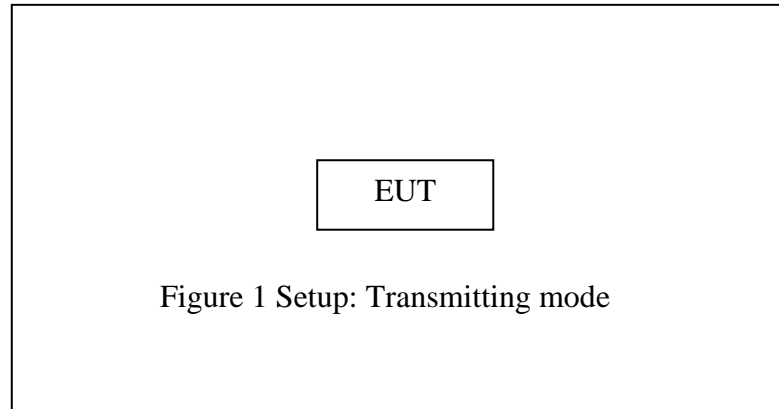

(EUT: Wireless BBQ thermometer)

4.1.2. Semi-Anechoic Chamber Test Setup Diagram

(A) Radiated Emission Test Set-Up, Frequency below 30MHz

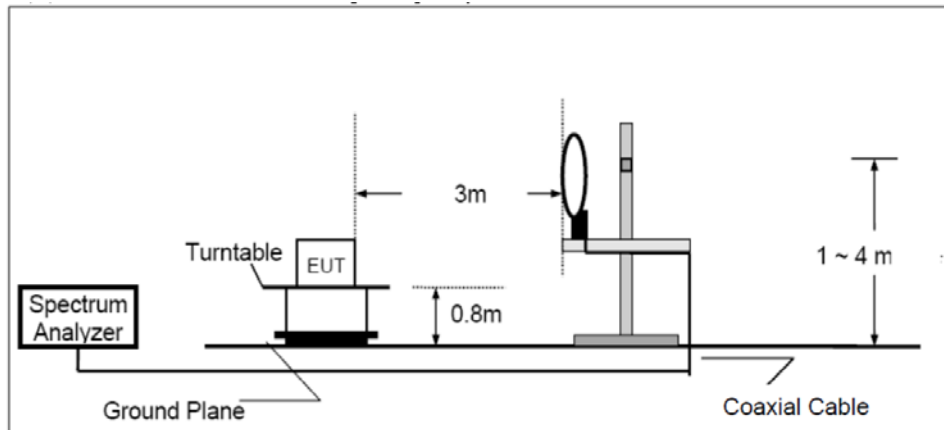

(B) Radiated Emission Test Set-Up, Frequency below 1GHz

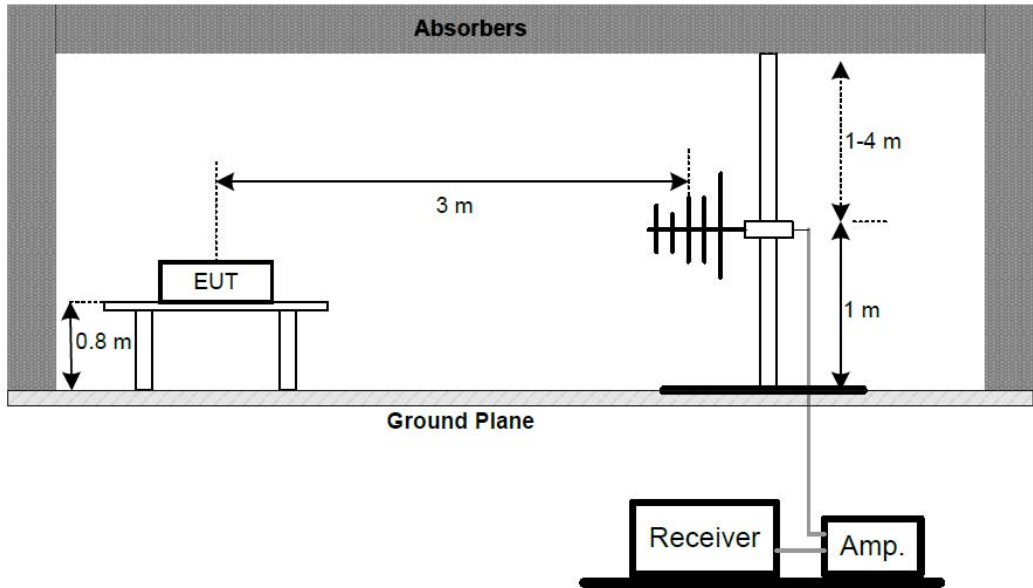

(C) Radiated Emission Test Set-Up, Frequency Above 1GHz

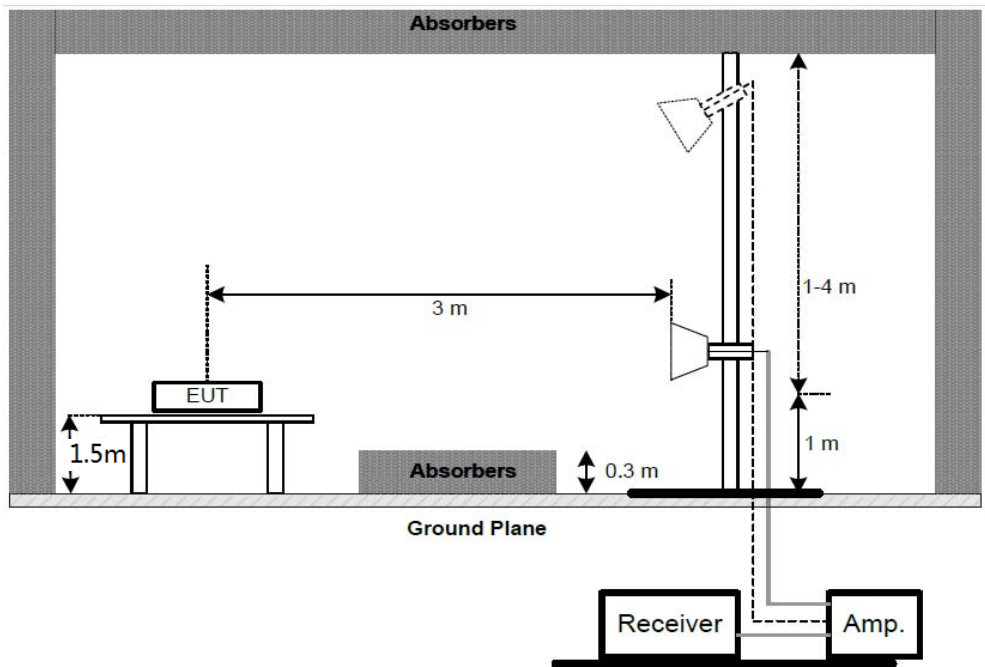

4.2. The Field Strength of Radiation Emission Measurement Limits

4.2.1. Radiation Emission Measurement Limits According to FCC Part 15 Section 15.231(e)

Funda- mental fre- quency (MHz)	Field strength of fun- damental (microvolts/ meter)	Field strength of spu- rious emission (microvolts/meter)
40.66– 40.70.	1,000	100
70–130	500	50
130–174	500 to 1,500 ¹	50 to 150 ¹
174–260	1,500	150
260–470	1,500 to 5,000 ¹	150 to 500 ¹
Above 470	5,000	500

¹ Linear interpolations.

4.2.2. Restricted Band Radiation Emission Measurement Limits According to FCC part 15 Section 15.205 and Section 15.209.

4.3. Configuration of EUT on Measurement

The following equipment is installed on Radiated Emission Measurement to meet the commission requirements and operating regulations in a manner which tends to maximize its emission characteristics in normal application.

4.4. Operating Condition of EUT

4.4.1. Setup the EUT and simulator as shown as Section 4.1.

4.4.2. Turn on the power of all equipment.

4.4.3. Let the EUT work in TX mode measure it.

4.5. Test Procedure

The EUT and its simulators are placed on a turntable, which is 0.8 meter high above ground(Below 1GHz). The EUT and its simulators are placed on a turntable, which is 1.5 meter high above ground(Above 1GHz). The turntable can rotate 360 degrees to determine the position of the maximum emission level. EUT is set 3.0 meters away from the receiving antenna, which is mounted on an antenna tower. The antenna can be moved up and down between 1.0 meter and 4 meters to find out the maximum emission level. Broadband antenna (calibrated bi-log antenna) is used as receiving antenna. Both horizontal and vertical polarizations of the antenna are set on measurement. In order to find the maximum emission levels, all of the EUT location must be manipulated according to ANSI C63.10:2013 on radiated emission measurement. The EUT was tested in 3 orthogonal planes.

The bandwidth of test receiver is set at 120 kHz in 30-1000 MHz, and 1 MHz in 1000-5000 MHz.

The frequency range from 9 kHz to 5000 MHz is checked.

The test frequency is from 9KHz to 5000 MHz, The radiation emission from 9KHz-30MHz is not reported, because the levels are too low against the limit.

4.6. Data Sample

Frequency (MHz)	Reading (dBμv)	Factor (dB/m)	Result (dBμv/m)	Limit (dBμv/m)	Margin (dB)	Remark
X.XX	28.66	-15.19	13.47	40.0	-26.53	QP

Frequency(MHz) = Emission frequency in MHz

Reading(dBμv) = Uncorrected Analyzer/Receiver reading

Factor (dB/m) = Antenna factor + Cable Loss – Amplifier gain

Result(dBμv/m) = Reading(dBμv) + Factor(dB/m)

Limit (dBμv/m) = Limit stated in standard

Margin (dB) = Result(dBμv/m) - Limit (dBμv/m)

QP = Quasi-peak Reading

Calculation Formula:

Margin(dB) = Result (dBμV/m)–Limit(dBμV/m)

Result(dBμV/m)= Reading(dBμV)+ Factor(dB/m)

The “Margin” column of the following data tables indicates the degree of compliance with the applicable limit. For example, a margin of -7dB means the emission is 7dB below the limit.

4.7. The Field Strength of Radiation Emission Measurement Results PASS.

Frequency (MHz)	Reading (dB μ V/m)	Factor Corr.	Average Factor	Result(dB μ V/m)		Limit(dB μ V/m)		Margin(dB)		Polarization
	PEAK	(dB)	(dB)	AV	PEAK	AV	PEAK	AV	PEAK	
433.92	91.71	-13.51	-6.79	71.41	78.20	72.87	92.87	-1.46	-14.67	Horizontal
867.85	48.35	-5.01	-6.79	/	43.34	52.87	72.87	/	-29.53	
1301.76	60.99	-11.93	-6.79	/	49.06	52.87	72.87	/	-23.81	
433.92	91.68	-13.51	-6.79	71.38	78.17	72.87	92.87	-1.49	-14.70	Vertical
867.84	47.49	-5.01	-6.79	/	42.48	52.87	72.87	/	-30.39	
1301.76	61.92	-11.93	-6.79	/	49.99	52.87	72.87	/	-22.88	

Note:

1. Emissions attenuated more than 20 dB below the permissible value are not reported.
2. “/” indicates that this value is less than the limit, and does not have to be recorded.
3. The field strength is calculated by adding the antenna factor, high pass filter loss(if used) and cable loss, and subtracting the amplifier gain(if any)from the measured reading. The basic equation calculation is as follows:

$$\text{Result} = \text{Reading} + \text{Corrected Factor}$$

$$\text{Where Corrected Factor} = \text{Antenna Factor} + \text{Cable Loss} + \text{High Pass Filter Loss} - \text{Amplifier Gain}$$

4. FCC Limit for Average Measurement = $16.67 \times (433.92) - 2833.33 = 4400.1164 \mu\text{V/m} = 72.87 \text{ dB}\mu\text{V/m}$
5. The spectral diagrams in appendix I display the measurement of peak values.
6. Average value = PK value + Average Factor (duty factor)
7. If the peak-detected amplitude can be shown to comply with the average limit, then it is not necessary to perform a separate average measurement.
8. The EUT is tested radiation emission in three axes(X,Y,Z). The worst emissions are reported in three axes.
9. Pulse Desensitization Correction Factor
 Pulse Width (PW) = 0.7ms;
 $2/PW = 2/0.7\text{ms} = 0.15\text{kHz}$;
 RBW (100 kHz) > 2/PW (2.86 kHz),
 Therefore PDCF is not needed

5. 20DB OCCUPIED BANDWIDTH

5.1. Block Diagram of Test Setup



(EUT: Wireless BBQ thermometer)

5.2. The Bandwidth of Emission Limit According To FCC Part 15 Section

15.231(c)

The bandwidth of emission shall be no wider than 0.25% of the center frequency. Therefore, the bandwidth of the emission limit is $433.92 \text{ MHz} \times 0.25\% = 1084.8 \text{ kHz}$. Bandwidth is determined at the two points 20 dB down from the top of modulated carrier.

5.3. EUT Configuration on Measurement

The following equipment are installed on the bandwidth of emission Measurement to meet the commission requirements and operating regulations in a manner which tends to maximize its emission characteristics in normal application.

5.4. Operating Condition of EUT

5.4.1. Setup the EUT and simulator as shown as Section 5.1.

5.4.2. Turn on the power of all equipment.

5.4.3. Let the EUT work in TX mode measure it.

5.5. Test Procedure

5.5.1. Set SPA Center Frequency = Fundamental frequency, RBW = 10 kHz, VBW = 30 kHz, Span = 1MHz.

5.5.2. Set SPA Max hold, Mark peak, -20 dB.

5.6.Measurement Result

The EUT does meet the FCC requirement.

-20 dB bandwidth = 45kHz < $433.92\text{MHz} \times 0.25\%$ = 1084.8kHz.

The spectral diagrams in appendix I.

6. RELEASE TIME MEASUREMENT

6.1. Block Diagram of Test Setup



(EUT: Wireless BBQ thermometer)

6.2. Release Time Measurement According To FCC Part 15 Section 15.231(e)

Section 15.231(e) devices operated under the provisions of this paragraph shall be provided with a means for automatically limiting operation so that the duration of each transmission shall not be greater than one second and the silent period between transmissions shall be at least 30 times the duration of the transmission but in no case less than 10 seconds.

6.3. EUT Configuration on Measurement

The following equipment are installed on Release Time Measurement to meet the commission requirements and operating regulations in a manner which tends to maximize its emission characteristics in normal application.

6.4. Operating Condition of EUT

6.4.1. Setup the EUT and simulator as shown as Section 6.1.

6.4.2. Turn on the power of all equipment.

6.4.3. Let the EUT work in TX mode measure it.

6.5. Test Procedure

6.5.1. Set SPA Center Frequency = Fundamental frequency, RBW = 100 kHz, VBW = 300 kHz, Span = 0 Hz.

6.5.2. Set EUT as normal operation.

6.5.3. Set SPA View. Delta Mark time.

6.6. Measurement Result

Test result: pass

Total period between transmission = 16.08s

Transmission Period = 341ms = 0.341s

Silent Period = (16.08s-0.341s) = 15.739s

Silent period complies with 15.231(e) limits , as silent period = 15.739 > 30*0.341s=10.23s and > 10s

The spectral diagrams in appendix I.

7. AVERAGE FACTOR MEASUREMENT

7.1. Block Diagram of Test Setup



(EUT: Wireless BBQ thermometer)

7.2. Average factor Measurement according to ANSI C63.10-2013

ANSI C63.10-2013 Section 7.5 Unless otherwise specified, when the radiated emission limits are expressed in terms of the average value of the emission, and pulsed operation is employed, the measurement field strength shall be determined by averaging over one complete pulse train, including blanking intervals, as long as the pulse train does not exceed 0.1 s (100 ms). In cases where the pulse train exceeds 0.1 s, the measured field strength shall be determined during a 0.1 s interval.⁶⁴ The following procedure is an example of how the average value may be determined. The average field strength may be found by measuring the peak pulse amplitude (in log equivalent units) and determining the duty cycle correction factor (in dB) associated with the pulse modulation as shown in Equation (10):

Average factor in dB = 20 log (duty cycle)

7.3. EUT Configuration on Measurement

The following equipment are installed on average factor Measurement to meet the commission requirements and operating regulations in a manner which tends to maximize its emission characteristics in normal application.

7.4. Operating Condition of EUT

7.4.1. Setup the EUT and simulator as shown as Section 7.1.

7.4.2. Turn on the power of all equipment.

7.4.3. Let the EUT work in TX mode measure it.

7.5. Test Procedure

7.5.1. The time period over which the duty cycle is measured is 100 milliseconds, or the repetition cycle, whichever is a shorter time frame. The worst case (highest percentage on) duty cycle is used for the calculation.

7.5.2. Set SPA Center Frequency = Fundamental frequency, RBW = 100 kHz, VBW = 300 kHz, Span = 0 Hz.

7.5.3. Set EUT as normal operation.

7.5.4. Set SPA View. Delta Mark time.

7.6. Measurement Result

The duty cycle is simply the on time divided by the period:

Effective period of the cycle = $63 \times 0.7 + 1.68$ ms = 45.78ms

DC = $45.78\text{ms} / 100\text{ms} = 0.4578\%$

Therefore, the average factor is found by $20\log 0.4578 = -6.79\text{dB}$

The spectral diagrams in appendix I.

8. ANTENNA REQUIREMENT

8.1.The Requirement

According to Section 15.203, an intentional radiator shall be designed to ensure that no antenna other than that furnished by the responsible party shall be used with the device.

8.2.Antenna Construction

Device is equipped with permanent attached antenna, which isn't displaced by other antenna. The Max Antenna gain of EUT is 0dBi. Therefore, the equipment complies with the antenna requirement of Section 15.203.

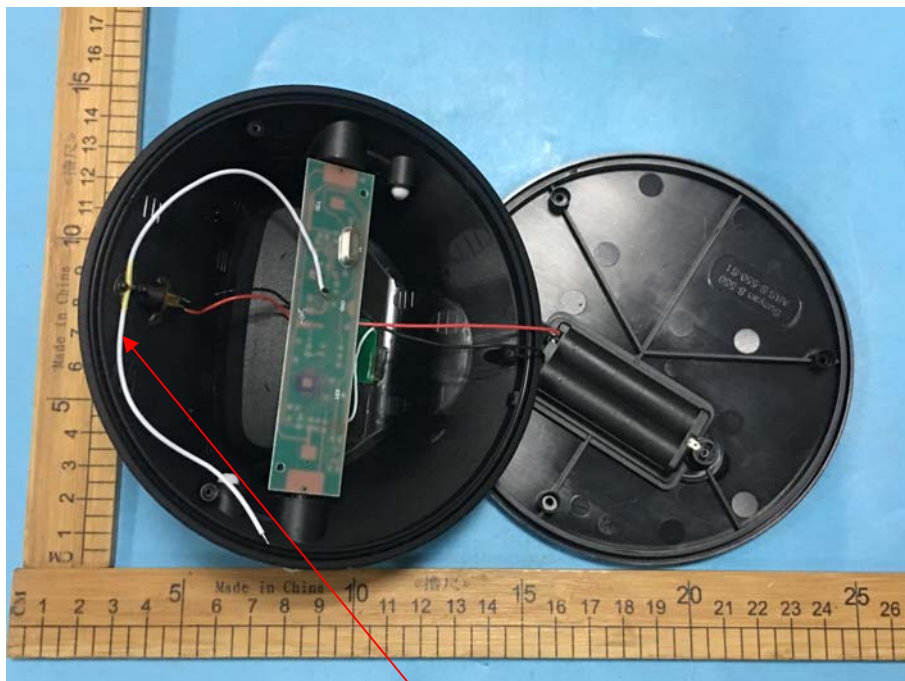

Wire Antenna

APPENDIX I

(Test Curves)



ACCURATE TECHNOLOGY CO., LTD.

F1,Bldg,A,Changyuan New Material Port Keyuan Rd,
Science & Industry Park,Nanshan Shenzhen,P.R.China

Site: 1# Chamber
Tel:+86-0755-26503290
Fax:+86-0755-26503396

Job No.: frank2018 #1701
Standard: FCC 15.231(e) 3M Radiated
Test item: Radiation Test
Temp.(C)/Hum.(%) 25 C / 55 %
EUT: Wireless BBQ thermometer
Mode: TX 433.92MHz
Model: 40128
Manufacturer: Mr. Bar-B-Q Products LLC

Polarization: Horizontal
Power Source: DC 3V
Date: 2018/09/19/
Time: 17/33/41
Engineer Signature:
Distance:

Note: Report NO.:ATE20181506

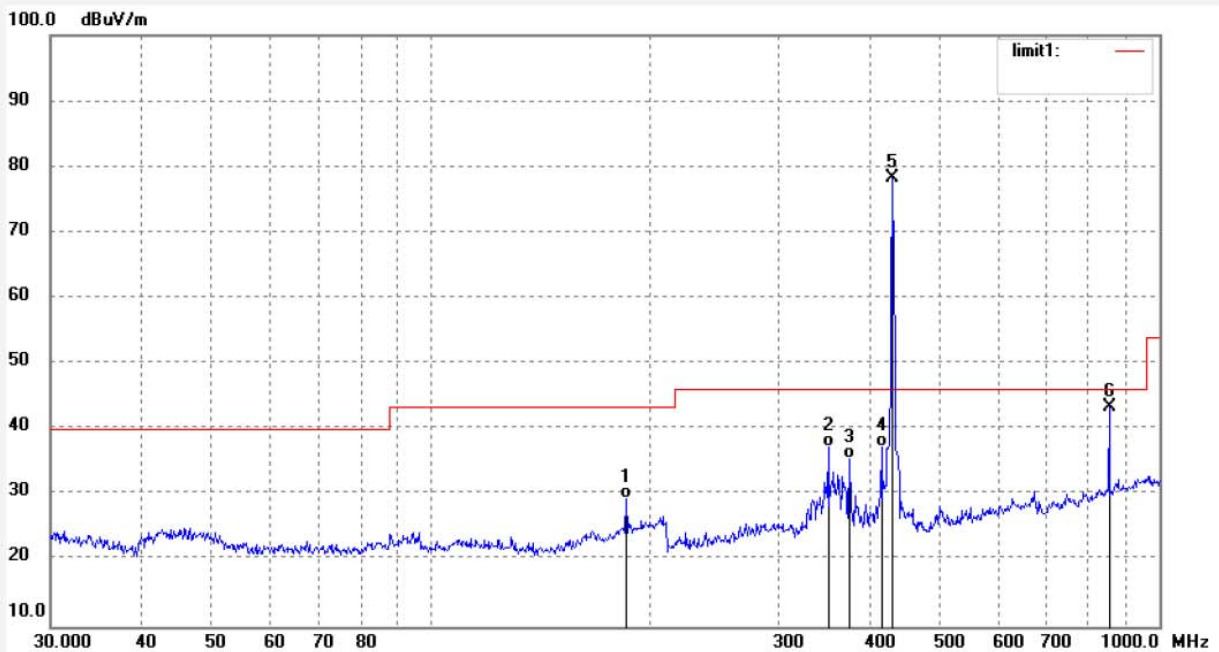

No.	Freq. (MHz)	Reading (dBuV/m)	Factor (dB)	Result (dBuV/m)	Limit (dBuV/m)	Margin (dB)	Detector	Height (cm)	Degree (deg.)	Remark
1	185.1624	49.40	-19.85	29.55	43.50	-13.95	QP	200	144	
2	350.9721	51.82	-14.59	37.23	46.00	-8.77	QP	200	59	
3	375.2022	49.64	-14.19	35.45	46.00	-10.55	QP	200	155	
4	415.4485	51.05	-13.74	37.31	46.00	-8.69	QP	200	302	
5	433.9252	91.71	-13.51	78.20	92.87	-14.67	peak	200	317	fundamental
6	867.8545	48.35	-5.01	43.34	72.87	-29.53	peak	200	124	



ACCURATE TECHNOLOGY CO., LTD.

F1,Bldg,A,Changyuan New Material Port Keyuan Rd,
Science & Industry Park,Nanshan Shenzhen,P.R.China

Site: 1# Chamber
Tel:+86-0755-26503290
Fax:+86-0755-26503396

Job No.: frank2018 #1700
Standard: FCC 15.231(e) 3M Radiated
Test item: Radiation Test
Temp.(C)/Hum.(%) 25 C / 55 %
EUT: Wireless BBQ thermometer
Mode: TX 433.92MHz
Model: 40128
Manufacturer: Mr. Bar-B-Q Products LLC

Polarization: Vertical
Power Source: DC 3V
Date: 2018/09/19/
Time: 17/31/48
Engineer Signature:
Distance:

Note: Report NO.:ATE20181506

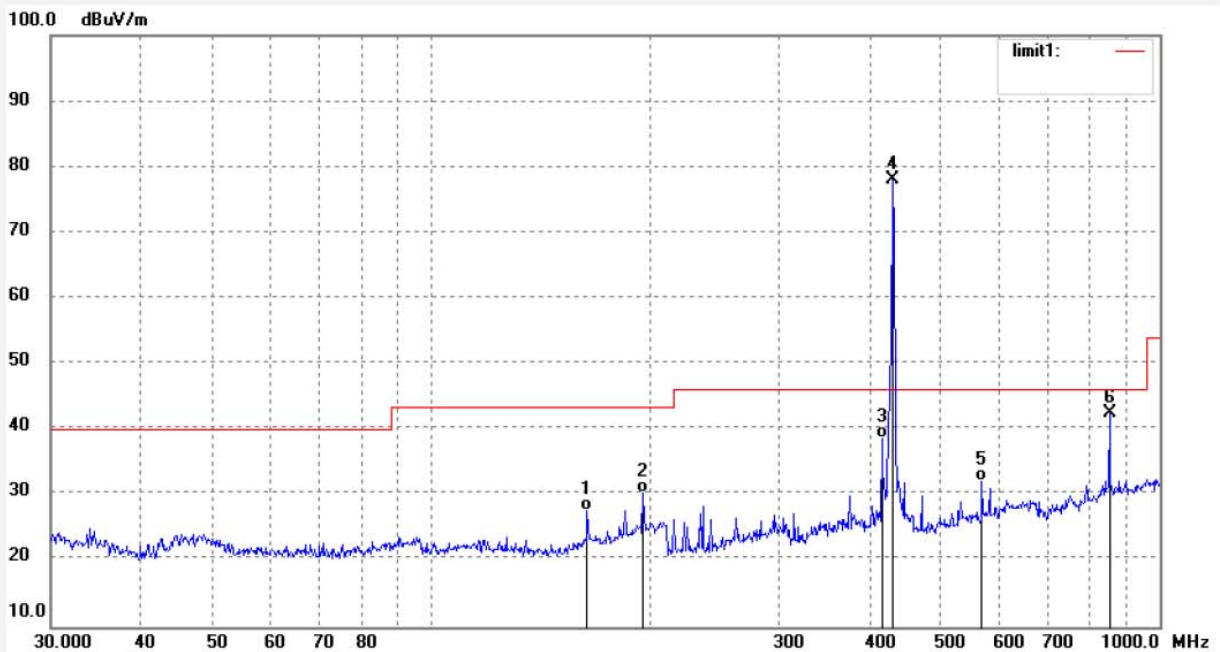

No.	Freq. (MHz)	Reading (dBuV/m)	Factor (dB)	Result (dBuV/m)	Limit (dBuV/m)	Margin (dB)	Detector	Height (cm)	Degree (deg.)	Remark
1	163.7366	48.63	-20.95	27.68	43.50	-15.82	QP	100	103	
2	195.1828	49.36	-18.96	30.40	43.50	-13.10	QP	100	219	
3	415.4485	52.39	-13.74	38.65	46.00	-7.35	QP	100	115	
4	433.9252	91.68	-13.51	78.17	92.87	-14.70	peak	100	128	fundamental
5	569.9687	42.82	-10.62	32.20	46.00	-13.80	QP	100	109	
6	867.8545	47.49	-5.01	42.48	72.87	-30.39	peak	100	127	

Job No.: frank2018 #1702
 Standard: FCC 15.231(e) 3M Radiated
 Test item: Radiation Test
 Temp.(C)/Hum.(%) 25 C / 55 %
 EUT: Wireless BBQ thermometer
 Mode: TX 433.92MHz
 Model: 40128
 Manufacturer: Mr. Bar-B-Q Products LLC

Polarization: Horizontal
 Power Source: DC 3V
 Date: 2018/09/19/
 Time: 17/35/55
 Engineer Signature:
 Distance:

Note: Report NO.:ATE20181506

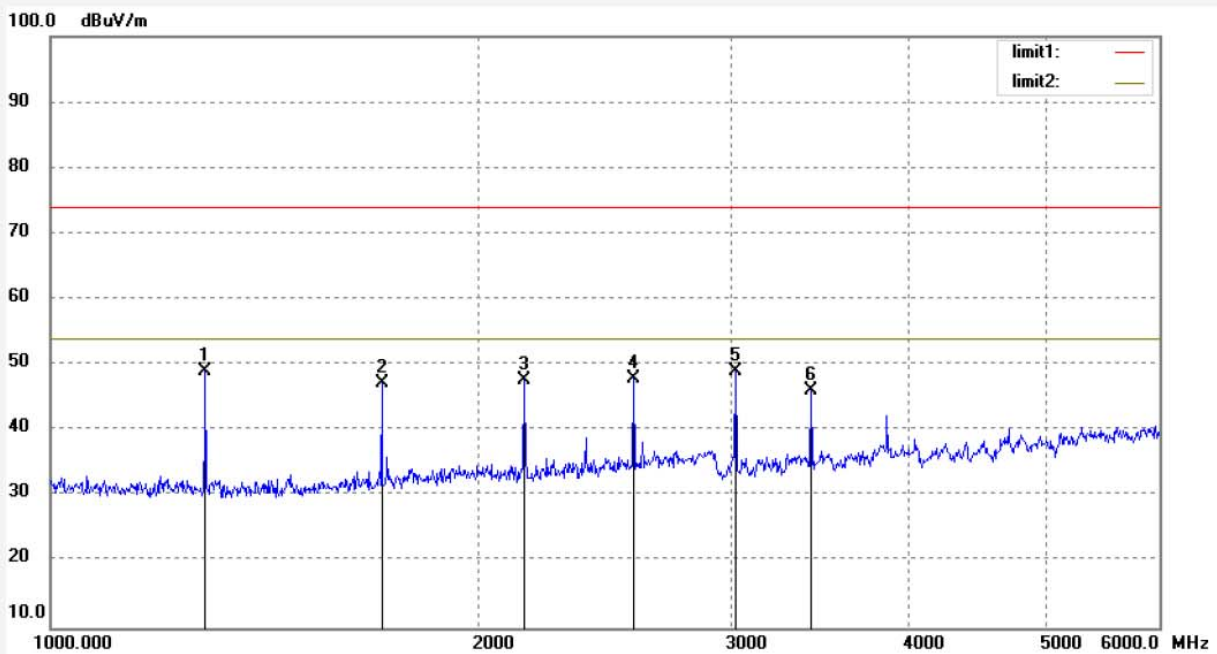

No.	Freq. (MHz)	Reading (dBuV/m)	Factor (dB)	Result (dBuV/m)	Limit (dBuV/m)	Margin (dB)	Detector	Height (cm)	Degree (deg.)	Remark
1	1301.762	60.99	-11.93	49.06	72.87	-23.81	peak	150	127	
2	1735.681	57.57	-10.36	47.21	72.87	-25.66	peak	150	218	
3	2169.647	56.41	-8.63	47.78	72.87	-25.09	peak	150	315	
4	2603.523	55.33	-7.51	47.82	72.87	-25.05	peak	150	319	
5	3037.446	55.08	-6.12	48.96	72.87	-23.91	peak	150	81	
6	3471.367	50.95	-4.77	46.18	72.87	-26.69	peak	150	165	

Job No.: frank2018 #1703
 Standard: FCC 15.231(e) 3M Radiated
 Test item: Radiation Test
 Temp.(C)/Hum.(%) 25 C / 55 %
 EUT: Wireless BBQ thermometer
 Mode: TX 433.92MHz
 Model: 40128
 Manufacturer: Mr. Bar-B-Q Products LLC

Polarization: Vertical
 Power Source: DC 3V
 Date: 2018/09/19/
 Time: 17/37/29
 Engineer Signature:
 Distance:

Note: Report NO.:ATE20181506

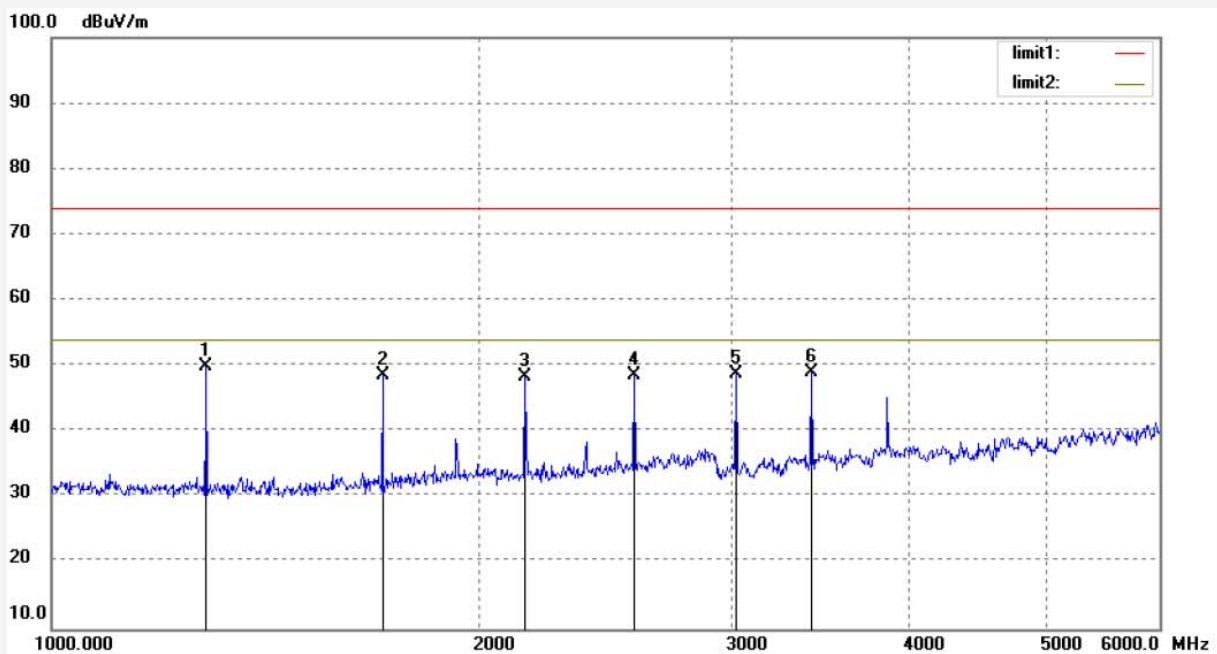

No.	Freq. (MHz)	Reading (dBuV/m)	Factor (dB)	Result (dBuV/m)	Limit (dBuV/m)	Margin (dB)	Detector	Height (cm)	Degree (deg.)	Remark
1	1301.762	61.92	-11.93	49.99	72.87	-22.88	peak	150	189	
2	1735.681	58.94	-10.36	48.58	72.87	-24.29	peak	150	173	
3	2169.647	57.07	-8.63	48.44	72.87	-24.43	peak	150	178	
4	2603.523	56.20	-7.51	48.69	72.87	-24.18	peak	150	321	
5	3037.446	55.01	-6.12	48.89	72.87	-23.98	peak	150	317	
6	3471.367	53.89	-4.77	49.12	72.87	-23.75	peak	150	216	

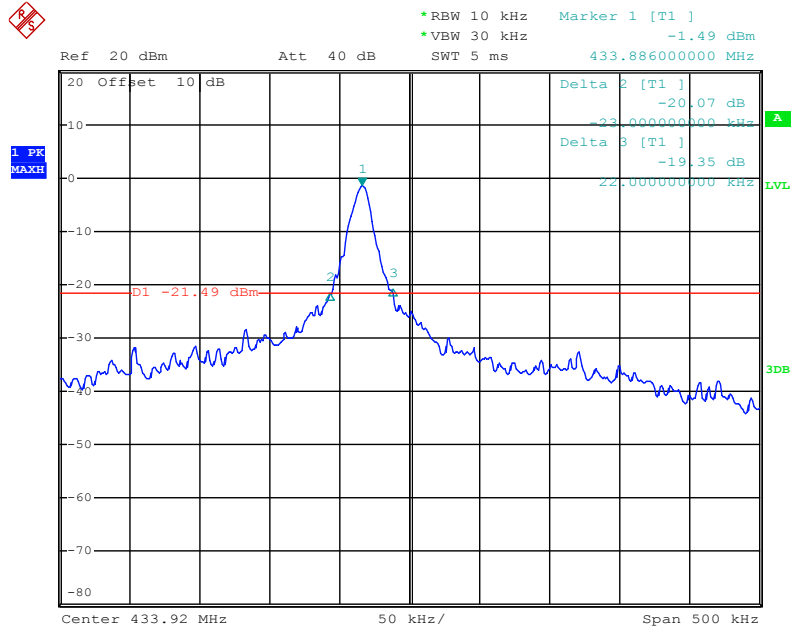

Date: 18.SEP.2018 18:48:33

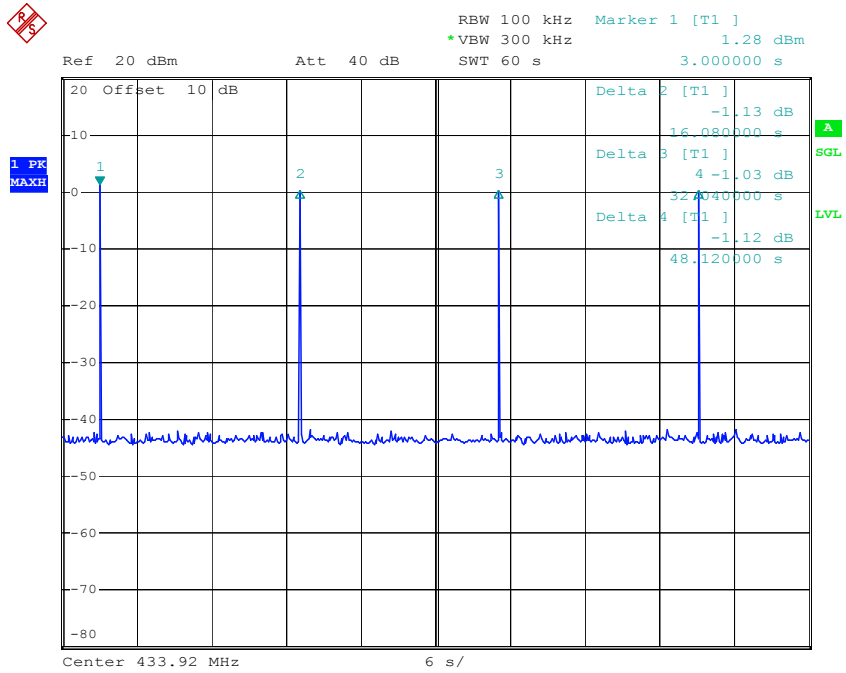

Date: Fİ.UÖŞ.2018 10:50:43

The period between transmissions =16.08s

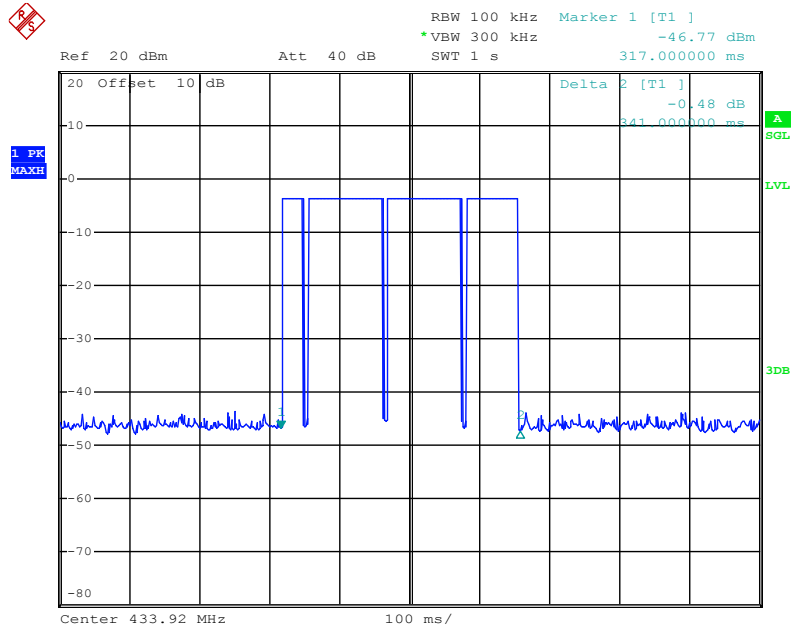

Date: 18.SEP.2018 18:55:37

The graph shows the duration of 'on' signal. From marker 1 to Delta 1, duration is 341ms.

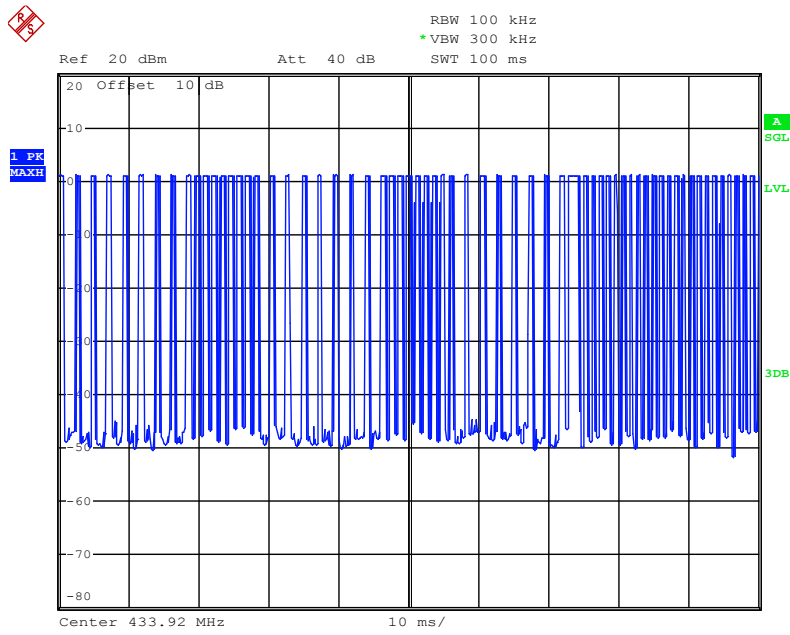

Date: 19.SEP.2018 10:26:36

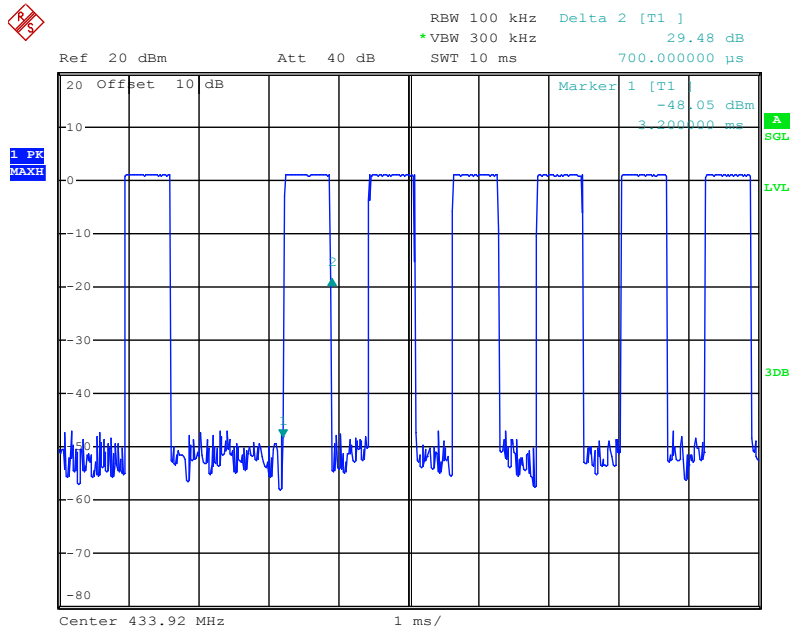

Date: 19.SEP.2018 10:27:12

The graph shows the duration of 'on' signal. From marker 1 to Delta 1, duration is 0.7ms.

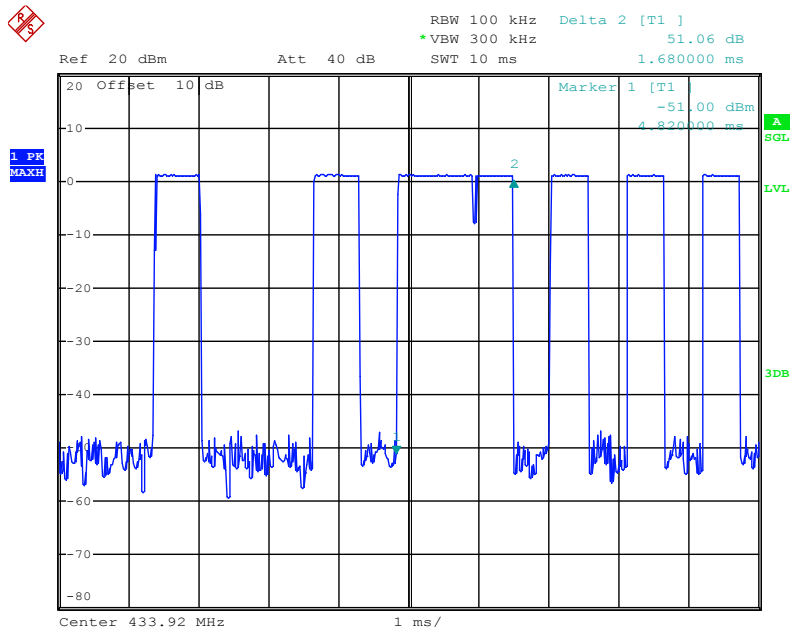

Date: 19.SEP.2018 10:28:38

The graph shows the duration of 'on' signal. From marker 1 to Delta 1, duration is 1.68ms.