

User Manual

Cradle: FCC ID:2ARHS-W2X

Ring: FCC ID:2ARHS-W26

Disclaimer

Disclaimer @ 2018 Hyco Genyong Technology Co., Ltd. All rights reserved.

Please read through the manual carefully before using the product and operate it according to the manual. It is advised that you should keep this manual for future reference.

Do not disassemble the device or remove the seal label from the device. Otherwise, Hyco Genyong Technology Co., Ltd. does not assume responsibility for the warranty or replacement.

The products depicted in this manual may include software copyrighted by Hyco Genyong Technology Co., Ltd. or a third party. The user, corporation or individual, shall not duplicate, in whole or in part, distribute, modify, decompile, disassemble, decode, reverse engineer, rent, transfer or sublicense such software without prior written consent from the copyright holders.

This manual is copyrighted. No part of this publication may be reproduced or used in any form without written permission from Hyco.

Hyco Genyong Technology Co., Ltd. reserves the right to make final interpretation of the statement above.

Hyco Genyong Technology Co., Ltd.

Design

Ring Scanner

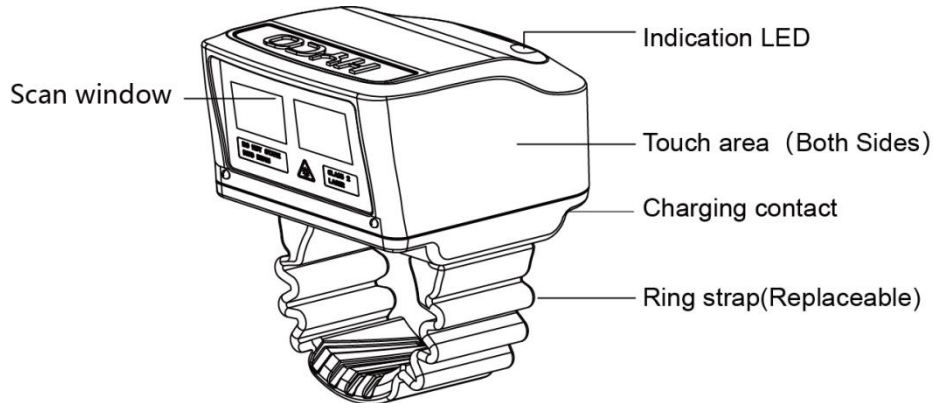

- Wearing: wear on index finger on left or right hand
- Scanning: touch either side of ring body with thumb finger to trigger the scanning

Ring scanner charging cradle (Bluetooth Receiver)

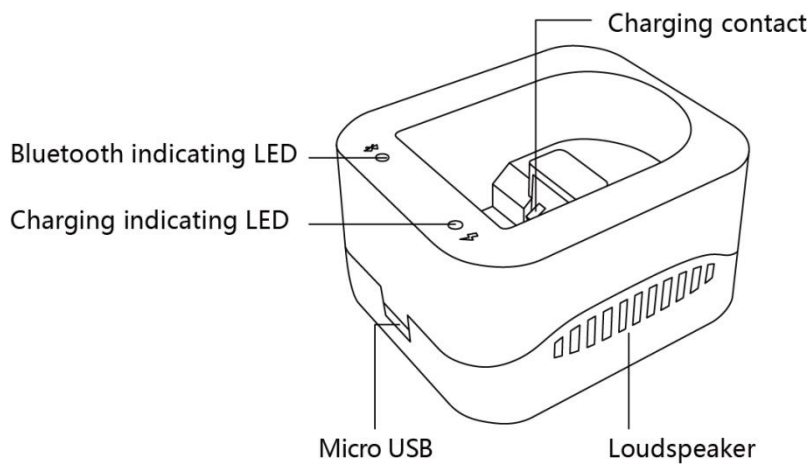

Charging

1. Charging Ring Scanner

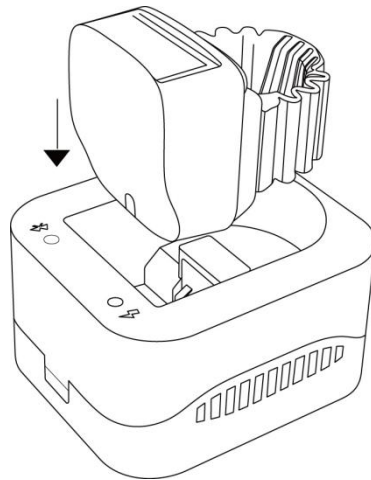

Charging Illustration 1

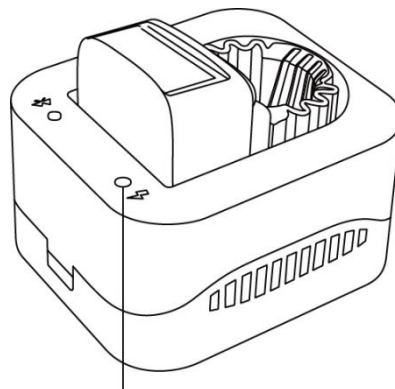

Red light: in charging
Green light: fully charged

Charging Illustration 2

- Connect the Ring scanner charging cradle to power, click the ring scanner into the bottom of cradle with the scan window upward. Please note the power contacts of the ring and cradle must be touched.
- The red light indicates it is in charging, when the green light turns on, it's finished charging.

Warning: don't look straightly into the scan window when scanning in case of harm to eyes.

2. Take the Ring Scanner out of the Ring scanner charging cradle

Hold the middle of the ring scanner gently and pull out upward from the cradle.

Bluetooth connection

Connect with PC:

- Firstly, connect the Ring scanner charging cradle with computer via USB cable, the green light on the cradle turns on. Secondly, after 15 seconds, Ring Scanner scans the "Bluetooth connection" barcode on the front of cradle, the blue light on the cradle indicates the Bluetooth

communication between ring scanner and cradle is successfully set up.

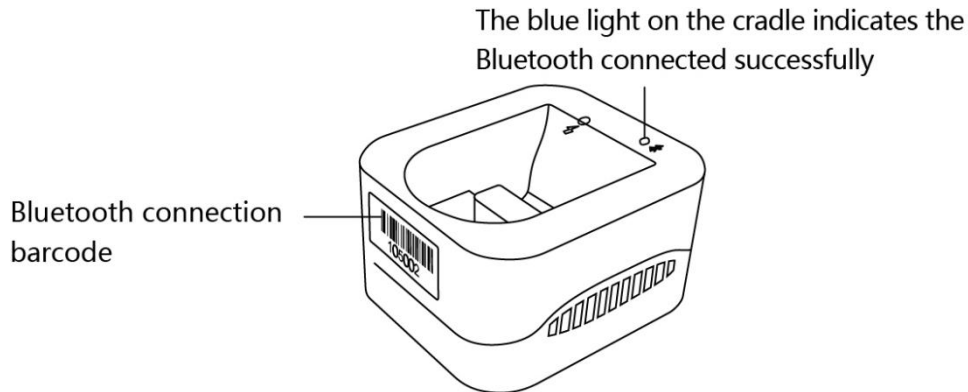

Connect with Tablet PC or phone:

- Enter the “ Setting ” in the Tablet PC or phone, click "Bluetooth search", find the Bluetooth serial number of the ring scanner, choose the corresponding Bluetooth serial number in the searching list. When the ring light turns on green, it indicates successful Bluetooth connection between ring and Tablet PC or phone.

Remark: Ring Scanner is the slave, and terminal device is the master

Use of applications (APP):

Prerequisites before connecting ring with different devices:

Change connection with different masters among computer, Tablet PC and phone.

When ring pairs with different terminal devices, user needs to scan different barcode before Bluetooth connection.

COMMON



To connect ring scanner with computer, please scan the barcode “COMMON” , but it is set by default.

IOS



To connect ring scanner with Smart Phone or Tablet PC based on IOS system, please scan the barcode "IOS".

ANDROID









To connect ring scanner with Smart Phone or Tablet PC based on Android system, please scan the barcode "ANDROID".

WINDOWS

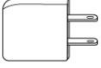

To connect ring scanner with Smart Phone or Tablet PC based on Windows system, please scan the barcode "WINDOWS".

Components

Components	Quantity	Usage
 Ring Scanner	1	1. Decode 1D bar codes 2. Bluetooth slave
 Ring cradle	1	1. Charging cradle 2. Bluetooth receiver
 Charging adapter	1	Connect adapter to power with USB cable
 USB cable	1	1. Connect charger to USB port 2. Connect charger to charging adapter
 Ring strap (swappable)	1	Five different sizes
 Certificate	1	Factory certification
 User manual	1	Device description and usage instruction

Specifications

Weight	20g (excluding ring strap)
Ring strap	10 pieces (5 different sizes)
Scanner	HYCO laser scanner
Laser wavelength	650nm
Bluetooth	BT4.0 BLE
USB	USB2.0
LED	Three different colors
Battery	200mAh@3.7V
Charging time	2.5 hours
Vibration reminder	Support
Charging cradle	Bluetooth receiver, Charging dock, Buzzer
Operating time	18 hours (scanning every 3 seconds)
Touch key	Touch more than 100 million times
Wearing way	on left or right index finger
IP Level	IP66
Drop test	Acceptable multiple drops from 3.0 meters to concrete
Operating temperature	-10°C to +50°C

Functions

1. Scanning

Wear on left or right index finger, touch left or right side of ring and aim at the barcode, the ring light turns green, it starts to scan.

2. Ring Straps

Firstly, straightly pull out ring strap from the slot, then choose another ring strap and push it to the top of slot.

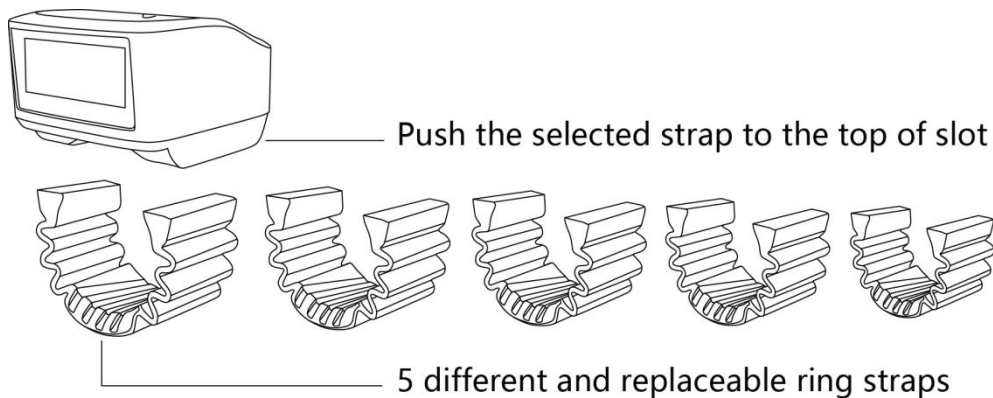

3. Ring Indicator

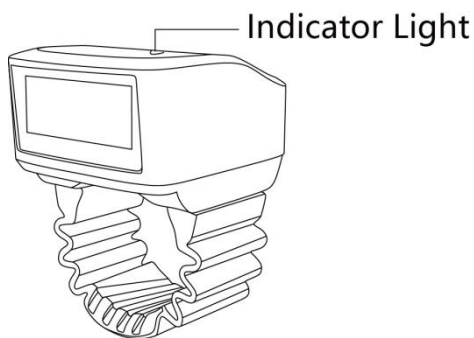

- The green light indicates successful scanning.
- The red light flashing indicates low battery.
- The green light keeping on for 1 second indicates successful Bluetooth connection.
- The blue light keeping on for 1 second indicates Bluetooth disconnection.
- The red, green and blue light flashing indicates restarting.

4. Bluetooth can't connect

Normally, if the Bluetooth light doesn't turn on, user can scan the barcode "Reset Bluetooth Name", wait for 10 seconds, and reconnect.

Reset Bluetooth Name



Restore factory settings



Scan the barcode “ Restore factory settings ” , the ring will

disconnect Bluetooth connection with terminal devices, and all the settings will change to factory default.

5. Charging cradle light indicator

The blue light indicates successful Bluetooth connection between ring scanner and cradle.

The green light indicates power on,

The red light indicates charging,

The red light off while the green light on in charging indicates fully charged.

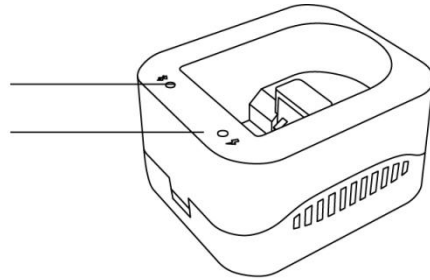

6. Wake up ring in charging

The ring doesn't work when in charging, while it could be waked up by touching either side of ring three times.

7. Laser calibration

If laser length changes longer or shorter, please stop scanning, touch ring for 4 seconds once and repeat several times to get it right. If it's still abnormal, please scan the barcode “Automatic calibration” .

Restore factory settings



After scan the barcode “Automatic laser calibration” , the ring

turns on purple, put it on the table, wait for 15 seconds until the purple light turns off. The ring laser is calibrated right and functions normally.

SERVICE

1.Warranty: one year for ring scanner, half year for battery and accessories.

2.Contact: junqi.zheng@hyco.cc

Notice

» The ring window must be kept clean. Improper usage will breach the limited warranty clause.

» Avoid rough objects scratching the window.

» Remove stains from window by soft cloth.

» Do not spray any liquid onto the window.

» Use cleaning water to clean.

Function barcodes setup

Change function of scanning after scanning the following barcodes:

Device information

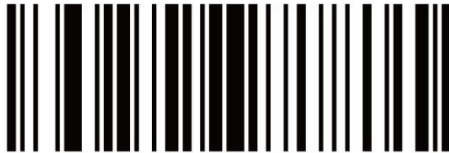

"Device information" barcode includes device information (e.g. serial number, version number, Bluetooth version information).

Vibration open



Vibration close



Scan function code “ Vibration Open ” to activate vibration function, Scan function code “ Vibration close ” to close

vibration function.

Slow down data transmission through ring cradle



Speed up data transmission through ring cradle



In HID mode, scan the barcode "Speed up data transmission through ring cradle", it can accelerate the data transmission speed between the cradle and computer; scan the barcode "Slow down data transmission through ring cradle", it can slow down the data transmission between the cradle and computer.

Triggered continuous scanning



Scan the barcode “Triggered continuous scanning”, ring could keep scanning when user keeps touching the ring.

If user wants to change to common scanning, scan the “Manual Trigger Mode” bar code.

Manual Trigger Scanning



"Manual Trigger Mode" is set by default, user needs to touch ring once to scan once.

Automatic Interval Scanning



After scan "Automatic interval scanning" bar code, ring could automatically scan every 0.5 ~ 3 seconds without touching (2 seconds by default)

Automatic interval scanning-reduce



After scan "Automatic interval scanning-reduce" barcode, it can expedite the scanning speed once by 0.5 second, the fastest

scanning speed is scanning once every 0.5 second.

Automatic interval scanning-increase



After scan "Automatic interval scanning-increase" barcode, it can slow down the scanning speed once by 0.5 second, the slowest scanning speed is scanning once every 3 seconds.

Scan angle adjustment

According to different barcode length, user needs to change laser length to achieve better scanning effect.

1、Scan “Laser calibration” barcode to activate the function, the ring light turns white and begins to automatically and intermittently scan.

Laser calibration



2、 After scan “Widen” barcode, the laser length becomes long; after scan “short” barcode, the scan angle becomes short .

Extend laser

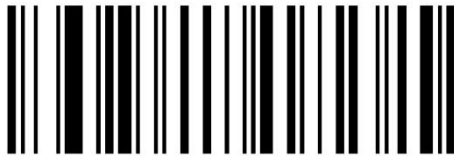

Shorten laser

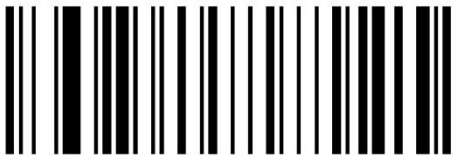

Note: do not extend or shorten more than 10 times one time.

3、 Scan “Confirm” barcode, the ring light turns yellow and white, the laser length is confirmed.

Laser confirm



4、 Scan “Data generation” barcode, the ring light turns yellow and red, and then turns purple for a while. The laser length is set successfully after the purple light turns off.

Data generation



Common functional barcodes

To meet different needs for customers, there are some functional barcodes used to meet the requirements for different customers.

Add Enter



Delete Enter



After scan “Add Enter” barcode, it can automatically move to next line in the text field after each scanning. If user wants to close the function, scan “Delete Enter” barcode.

Add TAB



Delete TAB



After scan "Add the tab" barcode, it can automatically move to next line in excel after each scanning. If user wants to close the function, scan "Delete the tab" barcode.

Note:

USB connection port information:

Due to the used enclosure material, the product shall only be connected to a USB Interface of version 2.0 or higher. The connection to so called power USB is prohibited.

Temperature information:

When charging, please place the device in an environment that has a good ventilation. It is recommended to charge the device in an environment with a temperature that ranges from 0°C~40°C.

Please ensure to use only the charger offered by the manufacturer.

Using unauthorized charger may cause danger and violate the authorization of the device and the guarantee article.

Battery information:

CAUTION RISK OF EXPLOSION IF BATTERY IS REPLACED BY AN INCORRECT TYPE. DISPOSE OF USED BATTERIES ACCORDING TO THE INSTRUCTIONS

Adapter information:

AC Adapter 1	Model: UT-133E-5100, Output: 5.0V \pm 1.0A
AC Adapter 2	Model: UT-200B-5100C, Output: 5.0V \pm 1.0A
AC Adapter 3	Model: NBS05B050100VKU, Output: 5.0V \pm 1.0A
AC Adapter 4	Model: SK13G1-0500100V, Output: 5.0V \pm 1.0A
Note1: The plug considered as disconnect device of adapter.	
Note2: The adapter shall be installed near the equipment and shall be easily accessible.	

Operating Frequency Range and Max Output Power

Ring Scanner	Frequency Range	2402MHz to 2480MHz
	Equipment type	Bluetooth LE 1M
	Max EIRP	-2.47 dBm
Ring scanner charging cradle	Frequency Range	2402MHz to 2480MHz
	Equipment type	Bluetooth LE 1M
	Max EIRP	-2.31 dBm

RF exposure information:

Max output power is less than 20mW, only need RF Exposure assessment, Meet the requirement EN 62479 :2010

EU Regulatory Conformance

Hereby, Hyco Genyong Technology Co., Ltd. declares that this device is in compliance with the essential requirements and other relevant provisions of Directive 2014/53/EU.

For the declaration of conformity, visit the Web site: www.hyco.cc/certification.



Scope of application

This product can be used across EU member states

Manufacturer Information

Manufacturer	Hyco Genyong Technology Co., Ltd.
Address	Room 105, 1/F, Building B, No.999 of Huaxu Road, Qingpu District, Shanghai, CN

Federal Communication Commission (FCC) Radiation Exposure Statement

Cradle: When using the product, maintain a distance of 20cm from the body to ensure compliance with RF exposure requirements.

Ring: The device has been evaluated to meet general RF exposure requirement, The device can be used in portable exposure condition without restriction Federal Communication Commission (FCC) Radiation Exposure Statement Power is so low that no RF exposure calculation is needed.

This device complies with part 15 of the FCC rules. Operation is subject to the following two conditions: (1) this device may not cause harmful interference, and (2) this device must accept any interference received, including interference that may cause undesired operation.

NOTE: The manufacturer is not responsible for any radio or TV interference caused by unauthorized modifications or changes to this equipment. Such modifications or changes could void the user's authority to operate the equipment. NOTE: This equipment has been tested and found to comply with the limits for a Class B digital device, pursuant to part 15 of the FCC Rules. These limits are designed to provide reasonable protection against harmful interference in a residential installation. This equipment generates uses and can radiate radio frequency energy and, if not installed and used in accordance with the instructions, may cause harmful interference to radio communications. However, there is no guarantee that interference will not occur in a particular installation. If this equipment does cause harmful interference to radio or television reception, which can be determined by turning the equipment off and on, the user is encouraged to try to correct the interference by one or more of the following measures:

- Reorient or relocate the receiving antenna.
- Increase the separation between the equipment and receiver.
- Connect the equipment into an outlet on a circuit different from that to which the receiver is connected.
- Consult the dealer or an experienced radio/TV technician for help.