



FCC Part 15C Test Report

FCC ID:2ARHE-T700

Product Name:	Robotic Vacuum Cleaner
Trademark:	N/A
Model Name :	T700
Prepared For :	Shenzhen Homer Technology Co.,Ltd
Address :	3rd Floor, Defei Industrial Park, No.50 Jinniu East Road, Pingshan District, Shenzhen, China
Prepared By :	Shenzhen BCTC Testing Co., Ltd.
Address :	BCTC Building & 1-2F, East of B Building, Pengzhou Industrial, Fuyuan 1st Road, Qiaotou Community, Fuyong Street, Bao'an District, Shenzhen, China
Test Date:	Sep. 30, 2018 to Oct. 18, 2018
Date of Report :	Oct. 18, 2018
Report No.:	BCTC-LH180902696E

TEST RESULT CERTIFICATION

Applicant's name Shenzhen Homer Technology Co.,Ltd
Address 3rd Floor, Defei Industrial Park, No.50 Jinniu East Road, Pingshan District, Shenzhen, China

Manufacturer's Name..... Shenzhen Homer Technology Co.,Ltd
Address 3rd Floor, Defei Industrial Park, No.50 Jinniu East Road, Pingshan District, Shenzhen, China

Product description



Product name Robotic Vacuum Cleaner
Trademark N/A

Model and/or type reference T700

Standards FCC Part15.247
ANSI C63.10:2013

This device described above has been tested by BCTC, and the test results show that the equipment under test (EUT) is in compliance with the FCC requirements. And it is applicable only to the tested sample identified in the report.

This report shall not be reproduced except in full, without the written approval of BCTC, this document may be altered or revised by BCTC, personal only, and shall be noted in the revision of the document.

Prepared by(Engineer):	Leke Xie	
Reviewer(Supervisor):	Eric Yang	
Approved(Manager):	Carson Zhang	



	Page
1 . SUMMARY OF TEST RESULTS	6
1.1 TEST FACILITY	7
1.2 MEASUREMENT UNCERTAINTY	7
2 . GENERAL INFORMATION	8
2.1 GENERAL DESCRIPTION OF EUT	8
2.2 DESCRIPTION OF TEST MODES	9
2.3 BLOCK DIGRAM SHOWING THE CONFIGURATION OF SYSTEM TESTED	10
2.4 DESCRIPTION OF SUPPORT UNITS(CONDUCTED MODE)	10
2.5 EQUIPMENTS LIST FOR ALL TEST ITEMS	11
3 . EMC EMISSION TEST	12
3.1 CONDUCTED EMISSION MEASUREMENT	12
3.1.1 POWER LINE CONDUCTED EMISSION LIMITS	12
3.1.2 TEST PROCEDURE	12
3.1.3 DEVIATION FROM TEST STANDARD	12
3.1.4 TEST SETUP	13
3.1.5 EUT OPERATING CONDITIONS	13
3.1.6 TEST RESULTS	14
3.2 RADIATED EMISSION MEASUREMENT	20
3.2.1 RADIATED EMISSION LIMITS	20
3.2.2 TEST PROCEDURE	20
3.2.3 DEVIATION FROM TEST STANDARD	21
3.2.4 TEST SETUP	21
3.2.5 EUT OPERATING CONDITIONS	22
3.2.6 TEST RESULTS (BETWEEN 9KHZ – 30 MHZ)	23
3.2.7 TEST RESULTS (BETWEEN 30MHZ – 1GHZ)	24
3.2.8 TEST RESULTS (1GHZ~25GHZ)	32
3.3 RADIATED BAND EMISSION MEASUREMENT	36
3.3.1 TEST REQUIREMENT:	36
3.3.2 TEST PROCEDURE	36
3.3.3 DEVIATION FROM TEST STANDARD	37
3.3.4 TEST SETUP	37
3.3.5 EUT OPERATING CONDITIONS	37
4 . POWER SPECTRAL DENSITY TEST	39

Table of Contents	Page
4.1 APPLIED PROCEDURES / LIMIT	39
4.1.1 TEST PROCEDURE	39
4.1.2 DEVIATION FROM STANDARD	39
4.1.3 TEST SETUP	39
4.1.4 EUT OPERATION CONDITIONS	39
4.1.5 TEST RESULTS	40
5 . BANDWIDTH TEST	48
5.1 APPLIED PROCEDURES / LIMIT	48
5.1.1 TEST PROCEDURE	48
5.1.2 DEVIATION FROM STANDARD	48
5.1.3 TEST SETUP	48
5.1.4 EUT OPERATION CONDITIONS	48
5.1.5 TEST RESULTS	49
6 . PEAK OUTPUT POWER TEST	57
6.1 APPLIED PROCEDURES/LIMIT	57
6.1.1 TEST PROCEDURE	57
6.1.2 DEVIATION FROM STANDARD	57
6.1.3 TEST SETUP	57
6.1.4 EUT OPERATION CONDITIONS	57
6.1.5 TEST RESULTS	58
7 . 100 KHZ BANDWIDTH OF FREQUENCY BAND EDGE	59
7.1 APPLICABLE STANDARD	59
7.2 TEST PROCEDURE	59
7.3 DEVIATION FROM STANDARD	59
7.4 TEST SETUP	59
7.5 EUT OPERATION CONDITIONS	59
7.1 TEST RESULTS	59
8 . DUTY CYCLE OF TEST SIGNAL	68
8.1 STANDARD REQUIREMENT	68
8.2 FORMULA:	68
9 . ANTENNA REQUIREMENT	71
9.1 STANDARD REQUIREMENT	71
9.2 EUT ANTENNA	71



Table of Contents

	Page
10 . EUT TEST PHOTO	72
11 . EUT PHOTO	74
APPENDIX-PHOTOGRAPHS OF EUT CONSTRUCTIONAL DETAILS	

1. SUMMARY OF TEST RESULTS

Test procedures according to the technical standards:

FCC Part15 (15.247) , Subpart C			
Standard Section	Test Item	Judgment	Remark
15.207	Conducted Emission	PASS	
15.247 (a)(2)	6dB Bandwidth	PASS	
15.247 (b)	Peak Output Power	PASS	
15.247 (d)	Radiated Spurious Emission	PASS	
15.247 (e)	Power Spectral Density	PASS	
15.205	Restricted Band of Operation	PASS	
15.247 (d)	Band Edge (Out of Band Emissions)	PASS	
15.203	Antenna Requirement	PASS	

NOTE:

(1) "N/A" denotes test is not applicable in this Test Report

1.1 TEST FACILITY

Shenzhen BCTC Testing Co., Ltd.

Add. : BCTC Building & 1-2F, East of B Building, Pengzhou Industrial, Fuyuan 1st Road, Qiaotou Community, Fuyong Street, Bao'an District, Shenzhen, China

FCC Test Firm Registration Number: 712850

IC Registered No.: 23583

1.2 MEASUREMENT UNCERTAINTY

The reported uncertainty of measurement $y \pm U$, where expended uncertainty U is based on a standard uncertainty multiplied by a coverage factor of $k=2$, providing a level of confidence of approximately **95 %**.

No.	Item	Uncertainty
1	Conducted Emission Test	$\pm 1.38\text{dB}$
2	RF power,conducted	$\pm 0.16\text{dB}$
3	Spurious emissions,conducted	$\pm 0.21\text{dB}$
4	All emissions,radiated(<1G)	$\pm 4.68\text{dB}$
5	All emissions,radiated(>1G)	$\pm 4.89\text{dB}$
6	Temperature	$\pm 0.5^{\circ}\text{C}$
7	Humidity	$\pm 2\%$

2. GENERAL INFORMATION

2.1 GENERAL DESCRIPTION OF EUT

Equipment	Robotic Vacuum Cleaner	
Trade Name	N/A	
Model Name	T700	
Model Difference	N/A	
Product Description	Operation Frequency:	802.11b/g/n20MHz:2412~2462 MHz 802.11n40MHz:2422~2452 MHz
	Modulation Type:	WIFI: OFDM/DSSS
	Bit Rate of Transmitter	802.11b:11/5.5/2/1 Mbps 802.11g:54/48/36/24/18/12/9/6Mbps 802.11n Up to 150Mbps
	Number Of Channel	802.11b/g/n20MHz:11 CH 802.11n40MHz: 7 CH
	Antenna Designation:	Please see Note 3.
	Based on the application, features, or specification exhibited in User's Manual, the EUT is considered as an ITE/Computing Device. More details of EUT technical specification, please refer to the User's Manual.	
Channel List	Please refer to the Note 2.	
Battery	2500mAh 14.52V 36.3Wh	
Adaptor	Model: DK18-190060H-U INPUT: 100-120V~50/60Hz 0.5A OUTPUT: 19V 0.6A	
Adaptor	Model: YJS015D-1900600U INPUT: 120VAC 60Hz 500mA OUTPUT: 19.0V -600mA	
Adaptor	Model: GSCU0600S019V12E INPUT: 100-240V~ 0.5A Max 50/60Hz OUTPUT: 19V -0.6A	
hardware version	N/A	
Software version	N/A	
Serial number	N/A	
Connecting I/O Port(s)	Please refer to the User's Manual	

Note:

1. For a more detailed features description, please refer to the manufacturer's specifications or the User's Manual.

2.

Channel List for 802.11b/g/n(20)							
Channel	Frequency (MHz)	Channel	Frequency (MHz)	Channel	Frequency (MHz)	Channel	Frequency (MHz)
01	2412	04	2427	07	2442	10	2457
02	2417	05	2432	08	2447	11	2462
03	2422	06	2437	09	2452		

Channel List for 802.11n(40)							
Channel	Frequency (MHz)	Channel	Frequency (MHz)	Channel	Frequency (MHz)	Channel	Frequency (MHz)
03	2422	05	2432	07	2442	09	2452
04	2427	06	2437	08	2447		

3.

Table for Filed Antenna

Ant.	Brand	Model Name	Antenna Type	Gain (dBi)	NOTE
1	N/A	N/A	PCB antenna	1	

2.2 DESCRIPTION OF TEST MODES

Pretest Mode	Description
Mode 1	802.11b CH1/ CH6/ CH11
Mode 2	802.11g CH1/ CH6/ CH11
Mode 3	802.11n20 CH1/ CH6/ CH11
Mode 4	802.11n40 CH3/ CH6/ CH9
Mode 5	Link Mode

Conducted Emission	
Final Test Mode	Description
Mode 5	Link Mode

For Radiated Emission	
Final Test Mode	Description
Mode 1	802.11b CH1/ CH6/ CH11
Mode 2	802.11g CH1/ CH6/ CH11
Mode 3	802.11n20 CH1/ CH6/ CH11
Mode 4	802.11n40 CH3/ CH6/ CH9

Note:

- (1) The measurements are performed at all Bit Rate of Transmitter, the worst data was reported.

2.3 BLOCK DIGRAM SHOWING THE CONFIGURATION OF SYSTEM TESTED

Conducted Emission Test

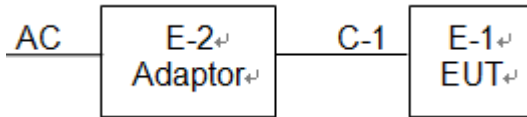

Radiated Spurious Emission

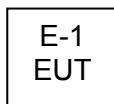

2.4 DESCRIPTION OF SUPPORT UNITS(CONDUCTED MODE)

The EUT has been tested as an independent unit together with other necessary accessories or support units. The following support units or accessories were used to form a representative test configuration during the tests.

Item	Equipment	Mfr/Brand	Model/Type No.	Series No.	Note
E-1	Robotic Vacuum Cleaner	N/A	T700	N/A	EUT
E-2	Adaptor	N/A	DK18-190060H-U	N/A	EUT
E-2	Adaptor	N/A	YJS015D-1900600U	N/A	EUT
E-2	Adaptor	N/A	GSCU0600S019V12E	N/A	EUT

Item	Shielded Type	Ferrite Core	Length	Note
C-1	NO	NO	1M	DC cable unshielded

Note:

- (1) The support equipment was authorized by Declaration of Confirmation.
- (2) For detachable type I/O cable should be specified the length in cm in 『Length』 column.

2.5 EQUIPMENTS LIST FOR ALL TEST ITEMS

Radiation Test equipment

Item	Equipment	Manufacturer	Type No.	Serial No.	Last calibration	Calibrated until
1	Spectrum Analyzer (9kHz-26.5GHz)	Agilent	E4407B	MY45109572	2018.06.20	2019.06.20
2	Test Receiver (9kHz-7GHz)	R&S	ESRP	101154	2018.06.20	2019.06.20
3	Bilog Antenna (30MHz-3GHz)	SCHWARZBEC K	VULB9163	VULB9163-942	2018.06.23	2019.06.23
4	Horn Antenna (1GHz-18GHz)	SCHWARZBEC K	BBHA9120D	1541	2018.06.23	2021.06.22
5	Horn Antenna (18GHz-40GHz)	SCHWARZBEC K	BBHA9170	822	2018.08.06	2019.08.06
6	Amplifier (9KHz-6GHz)	SCHWARZBEC K	BBV9744	9744-0037	2018.06.20	2019.06.20
7	Amplifier (0.5GHz-18GHz)	SCHWARZBEC K	BBV9718	9718-309	2018.06.20	2019.06.20
8	Amplifier (18GHz-40GHz)	MITEQ	TTA1840-35-H G	2034381	2018.08.06	2019.08.06
9	Loop Antenna (9KHz-30MHz)	SCHWARZBEC K	FMZB1519B	014	2018.06.23	2019.06.23
10	RF cables1 (9kHz-30MHz)	Huber+Suhnar	9kHz-30MHz	B1702988-0008	2018.02.12	2019.02.12
11	RF cables2 (30MHz-1GHz)	Huber+Suhnar	30MHz-1GHz	1486150	2018.03.27	2019.03.27
12	RF cables3 (1GHz-40GHz)	Huber+Suhnar	1GHz-40GHz	1607106	2018.06.19	2019.06.19
13	Power Metter	Keysight	E4419	\	2018.04.15	2019.04.15
14	Power Sensor (AV)	Keysight	E9300A	\	2018.04.15	2019.04.15
15	Signal Analyzer 20kHz-26.5GHz	KEYSIGHT	N9020A	MY49100060	2018.07.11	2019.07.11
16	Test Receiver 9kHz-40GHz	R&S	FSP40	100550	2018.06.13	2019.06.12
17	D.C. Power Supply	LongWei	TPR-6405D	\	\	\
18	Software	Frad	EZ-EMC	FA-03A2 RE	\	\

Conduction Test equipment

Item	Equipment	Manufacturer	Type No.	Serial No.	Last calibration	Calibrated until
1	Test Receiver	R&S	ESR3	102075	2018.06.20	2019.06.20
2	LISN	SCHWARZBECK	NSLK8127	8127739	2018.06.19	2019.06.19
3	LISN	R&S	ENV216	101375	2018.06.20	2019.06.20
4	RF cables	Huber+Suhnar	9kHz-30MHz	B1702988-0008	2018.02.12	2019.02.12
5	Software	Frad	EZ-EMC	EMC-CON 3A1	\	\

3. EMC EMISSION TEST

3.1 CONDUCTED EMISSION MEASUREMENT

3.1.1 POWER LINE CONDUCTED EMISSION Limits (Frequency Range 150KHz-30MHz)

FREQUENCY (MHz)	Limit (dBuV)		Standard
	Quasi-peak	Average	
0.15 -0.5	66 - 56 *	56 - 46 *	FCC
0.50 -5.0	56.00	46.00	FCC
5.0 -30.0	60.00	50.00	FCC

Note:

- (1) The tighter limit applies at the band edges.
- (2) The limit of " * " marked band means the limitation decreases linearly with the logarithm of the frequency in the range.

The following table is the setting of the receiver

Receiver Parameters	Setting
Attenuation	10 dB
Start Frequency	0.15 MHz
Stop Frequency	30 MHz
IF Bandwidth	9 kHz

3.1.2 TEST PROCEDURE

- a. The EUT was placed 0.1 meters from the horizontal ground plane with EUT being connected to the power mains through a line impedance stabilization network (LISN). All other support equipments powered from additional LISN(s). The LISN provide 50 Ohm/ 50uH of coupling impedance for the measuring instrument.
- b. Interconnecting cables that hang closer than 40 cm to the ground plane shall be folded back and forth in the center forming a bundle 30 to 40 cm long.
- c. I/O cables that are not connected to a peripheral shall be bundled in the center. The end of the cable may be terminated, if required, using the correct terminating impedance. The overall length shall not exceed 1 m.
- d. LISN at least 80 cm from nearest part of EUT chassis.
- e. For the actual test configuration, please refer to the related Item –EUT Test Photos.

3.1.3 DEVIATION FROM TEST STANDARD

No deviation



3.1.4 TEST SETUP

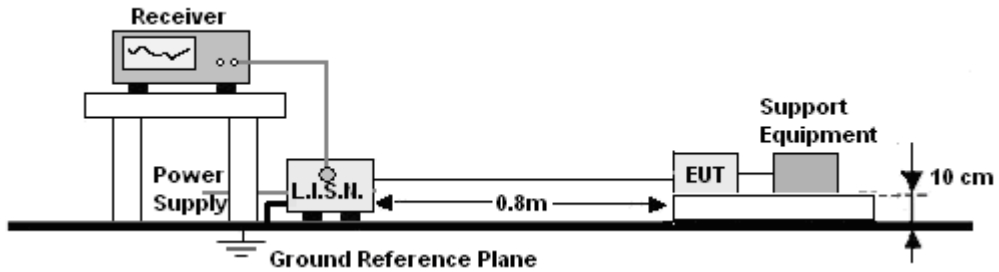

3.1.5 EUT OPERATING CONDITIONS

The EUT was configured for testing in a typical fashion (as a customer would normally use it). The EUT has been programmed to continuously transmit during test. This operating condition was tested and used to collect the included data.

We pretest AC 120V, the worst voltage was AC 120V and the data recording in the report.

3.1.6 TEST RESULTS

Temperature :	26 °C	Relative Humidity :	54%
Pressure :	101kPa	Phase :	L
Test Voltage :	DC 19V from adaptor(YJS015D-1900600U) AC120V 60Hz	Test Mode :	Mode 5

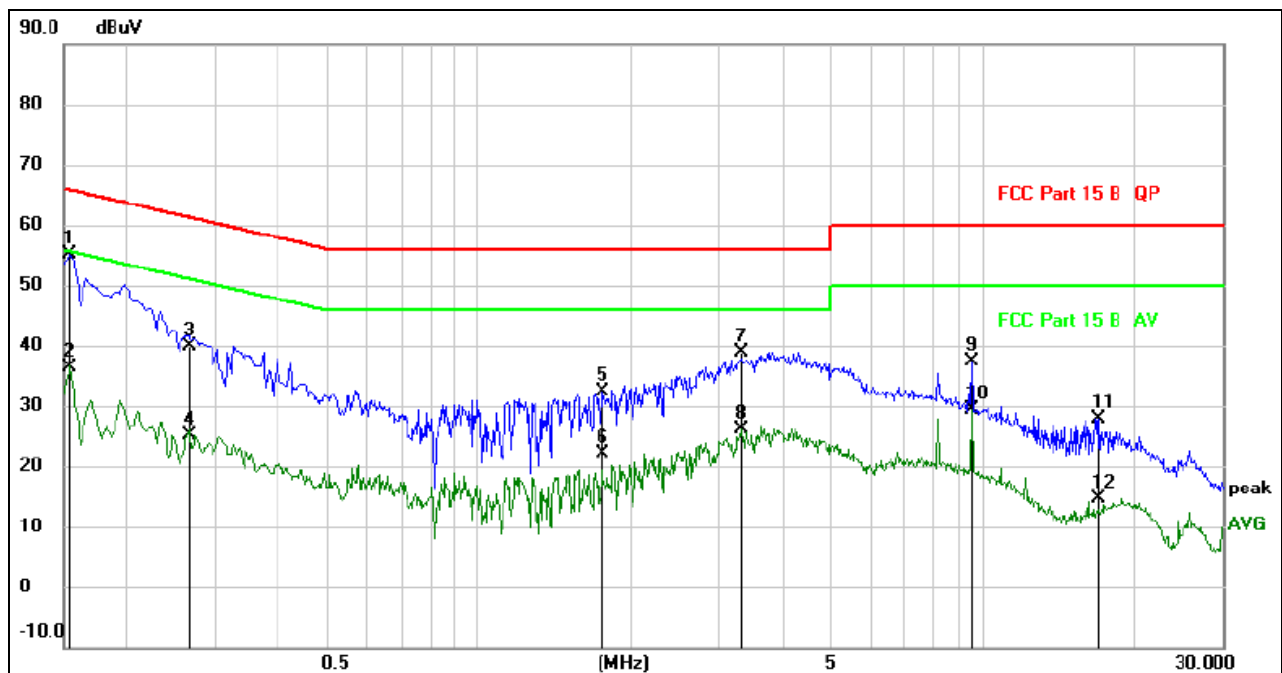

Remark:

1. All readings are Quasi-Peak and Average values.
2. Factor = Insertion Loss + Cable Loss.

No.	Mk.	Freq. MHz	Reading Level dBuV	Correct Factor	Measure- ment dBuV	Limit dBuV	Over dB	Detector	Comment
1	*	0.1539	45.56	9.52	55.08	65.79	-10.71	QP	
2		0.1539	26.98	9.52	36.50	55.79	-19.29	AVG	
3		0.2672	30.39	9.54	39.93	61.20	-21.27	QP	
4		0.2672	15.59	9.54	25.13	51.20	-26.07	AVG	
5		1.7540	22.71	9.59	32.30	56.00	-23.70	QP	
6		1.7540	12.48	9.59	22.07	46.00	-23.93	AVG	
7		3.3140	29.31	9.68	38.99	56.00	-17.01	QP	
8		3.3140	16.33	9.68	26.01	46.00	-19.99	AVG	
9		9.5140	27.69	9.69	37.38	60.00	-22.62	QP	
10		9.5140	19.76	9.69	29.45	50.00	-20.55	AVG	
11		17.0260	18.21	9.74	27.95	60.00	-32.05	QP	
12		17.0260	4.84	9.74	14.58	50.00	-35.42	AVG	



Temperature :	26 °C	Relative Humidity :	54%
Pressure :	101kPa	Phase :	N
Test Voltage :	DC 19V from adaptor(YJS015D-1900600U) AC120V 60Hz	Test Mode :	Mode 5

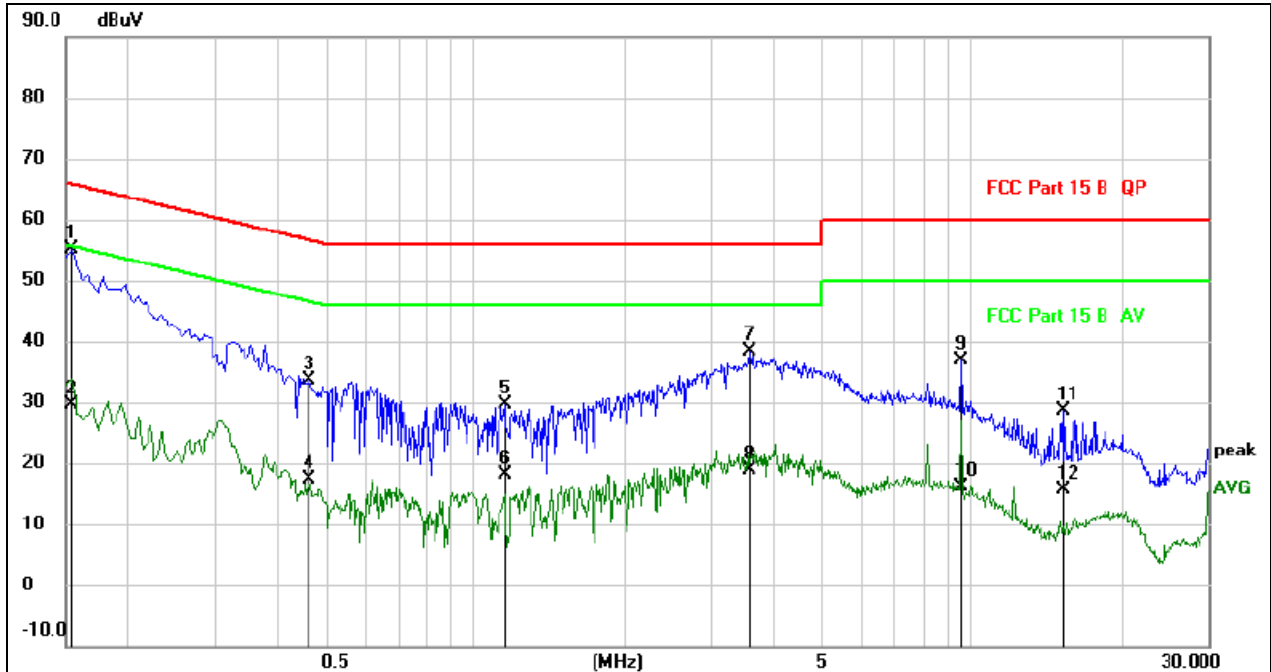

Remark:

1. All readings are Quasi-Peak and Average values.
2. Factor = Insertion Loss + Cable Loss.

No.	Mk.	Freq. MHz	Reading Level dBuV	Correct Factor	Measure- ment dBuV	Limit dBuV	Over dB	Detector	Comment
1	*	0.1539	45.57	9.52	55.09	65.79	-10.70	QP	
2		0.1539	20.08	9.52	29.60	55.79	-26.19	AVG	
3		0.4660	23.95	9.56	33.51	56.58	-23.07	QP	
4		0.4660	7.75	9.56	17.31	46.58	-29.27	AVG	
5		1.1500	20.13	9.57	29.70	56.00	-26.30	QP	
6		1.1500	8.64	9.57	18.21	46.00	-27.79	AVG	
7		3.5700	28.63	9.70	38.33	56.00	-17.67	QP	
8		3.5700	9.14	9.70	18.84	46.00	-27.16	AVG	
9		9.5140	27.11	9.69	36.80	60.00	-23.20	QP	
10		9.5140	6.38	9.69	16.07	50.00	-33.93	AVG	
11		15.3700	18.84	9.71	28.55	60.00	-31.45	QP	
12		15.3700	5.92	9.71	15.63	50.00	-34.37	AVG	



Temperature :	26 °C	Relative Humidity :	54%
Pressure :	101kPa	Phase :	L
Test Voltage :	DC 19V from adaptor(DK18-190060H-U) AC120V 60Hz	Test Mode :	Mode 5

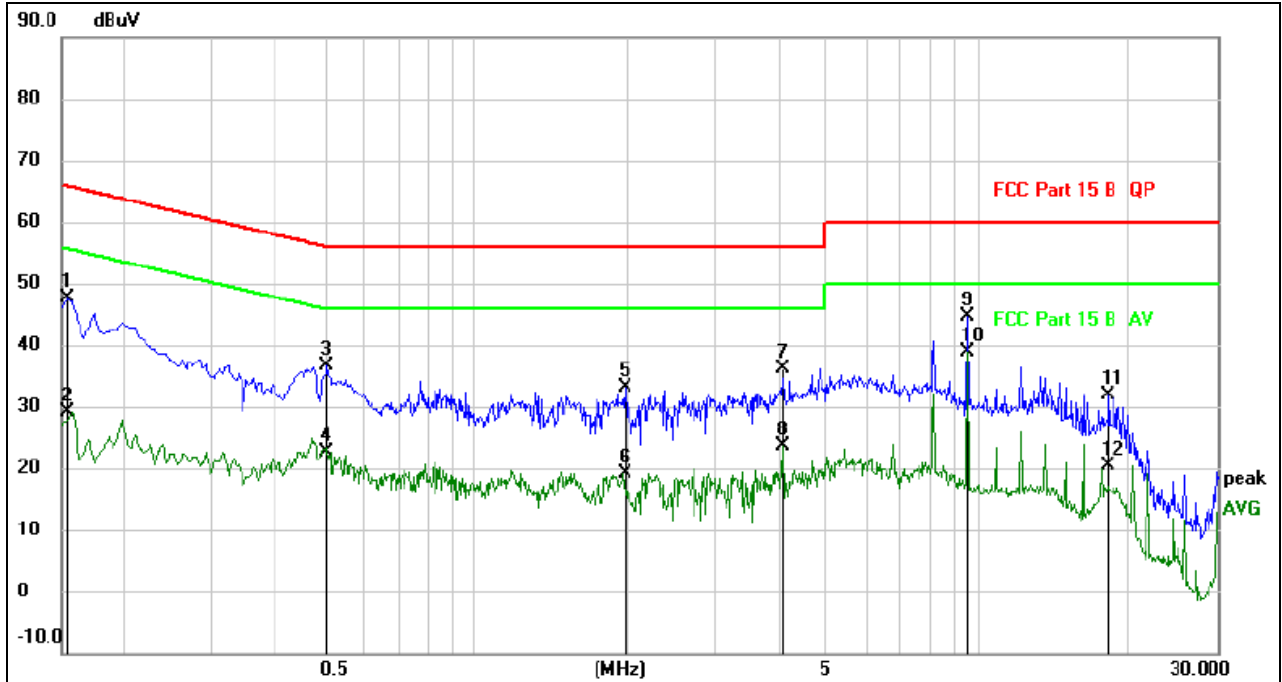

Remark:

1. All readings are Quasi-Peak and Average values.
2. Factor = Insertion Loss + Cable Loss.

No.	Mk.	Freq. MHz	Reading Level dBuV	Correct Factor	Measure- ment dBuV	Limit dBuV	Over dB	Detector	Comment
1		0.1539	38.04	9.52	47.56	65.79	-18.23	QP	
2		0.1539	19.70	9.52	29.22	55.79	-26.57	AVG	
3		0.5060	26.92	9.61	36.53	56.00	-19.47	QP	
4		0.5060	12.91	9.61	22.52	46.00	-23.48	AVG	
5		1.9820	23.48	9.59	33.07	56.00	-22.93	QP	
6		1.9820	9.61	9.59	19.20	46.00	-26.80	AVG	
7		4.0739	26.46	9.74	36.20	56.00	-19.80	QP	
8		4.0739	13.99	9.74	23.73	46.00	-22.27	AVG	
9		9.5060	34.90	9.69	44.59	60.00	-15.41	QP	
10	*	9.5060	29.22	9.69	38.91	50.00	-11.09	AVG	
11		18.1980	22.16	9.76	31.92	60.00	-28.08	QP	
12		18.1980	10.51	9.76	20.27	50.00	-29.73	AVG	



Temperature :	26 °C	Relative Humidity :	54%
Pressure :	101kPa	Phase :	N
Test Voltage :	DC 19V from adaptor(DK18-190060H-U) AC120V 60Hz	Test Mode :	Mode 5

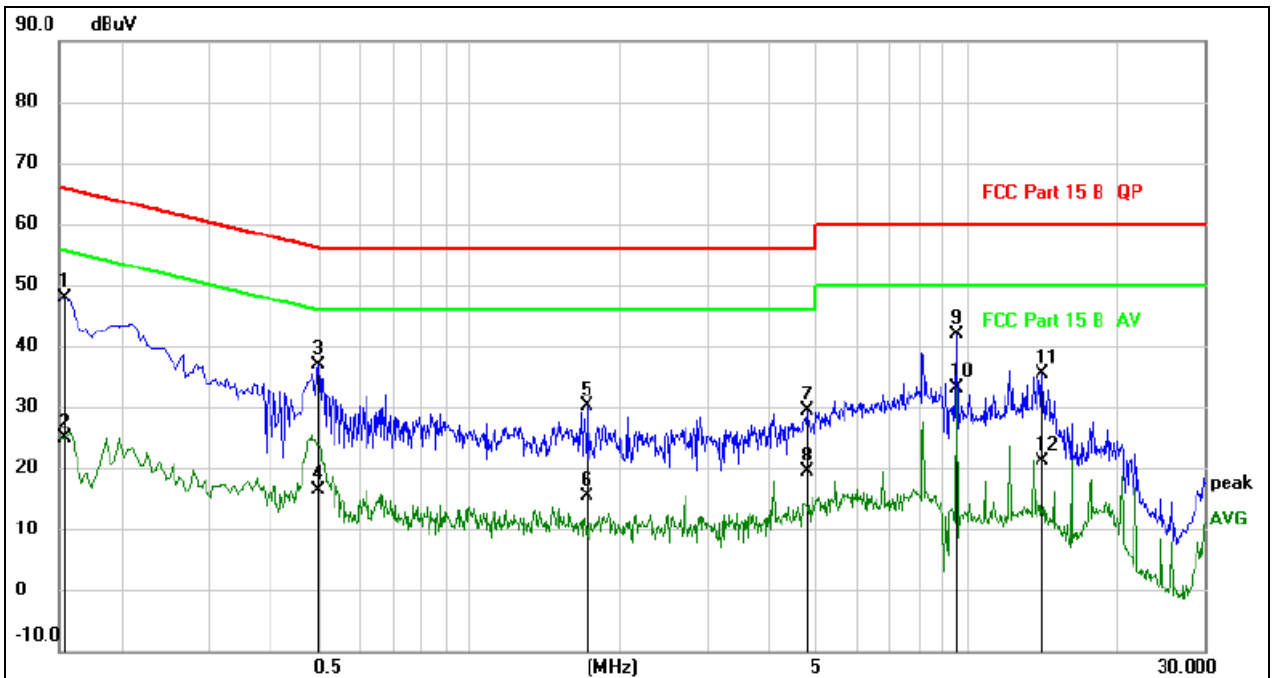

Remark:

1. All readings are Quasi-Peak and Average values.
2. Factor = Insertion Loss + Cable Loss.

No.	Mk.	Freq. MHz	Reading Level dBuV	Correct Factor	Measure- ment dBuV	Limit dBuV	Over dB	Detector	Comment
1		0.1539	38.46	9.52	47.98	65.79	-17.81	QP	
2		0.1539	15.46	9.52	24.98	55.79	-30.81	AVG	
3		0.4980	27.36	9.59	36.95	56.03	-19.08	QP	
4		0.4980	6.80	9.59	16.39	46.03	-29.64	AVG	
5		1.7260	20.49	9.58	30.07	56.00	-25.93	QP	
6		1.7260	5.74	9.58	15.32	46.00	-30.68	AVG	
7		4.7660	19.55	9.78	29.33	56.00	-26.67	QP	
8		4.7660	9.58	9.78	19.36	46.00	-26.64	AVG	
9		9.5140	32.13	9.69	41.82	60.00	-18.18	QP	
10	*	9.5140	23.51	9.69	33.20	50.00	-16.80	AVG	
11		14.2060	25.61	9.70	35.31	60.00	-24.69	QP	
12		14.2060	11.40	9.70	21.10	50.00	-28.90	AVG	



Temperature :	26 °C	Relative Humidity :	54%
Pressure :	101kPa	Phase :	L
Test Voltage :	DC 19V from adaptor(GSCU0600S019V12E)) AC120V 60Hz	Test Mode :	Mode 5

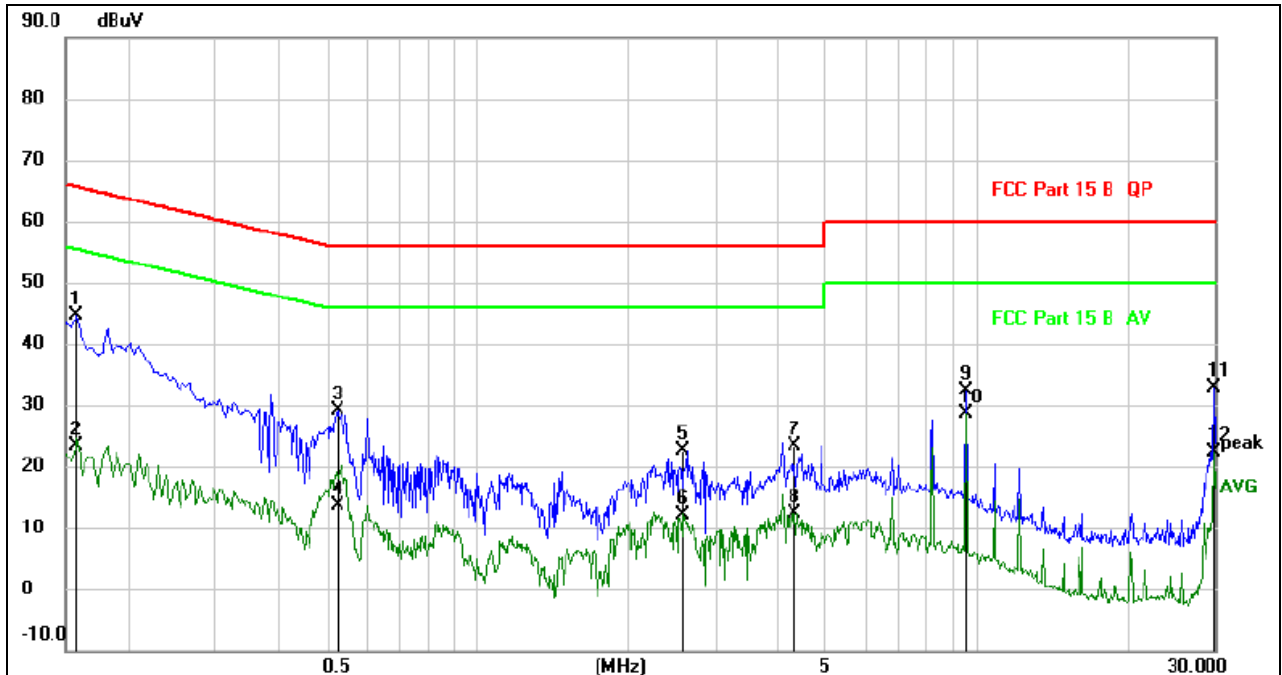

Remark:

1. All readings are Quasi-Peak and Average values.
2. Factor = Insertion Loss + Cable Loss.

No.	Mk.	Freq. MHz	Reading Level dBuV	Correct Factor	Measure- ment dBuV	Limit dBuV	Over dB	Detector	Comment
1	*	0.1580	35.07	9.51	44.58	65.57	-20.99	QP	
2		0.1580	13.77	9.51	23.28	55.57	-32.29	AVG	
3		0.5260	19.54	9.70	29.24	56.00	-26.76	QP	
4		0.5260	3.84	9.70	13.54	46.00	-32.46	AVG	
5		2.5900	12.96	9.63	22.59	56.00	-33.41	QP	
6		2.5900	2.62	9.63	12.25	46.00	-33.75	AVG	
7		4.3220	13.57	9.75	23.32	56.00	-32.68	QP	
8		4.3220	2.64	9.75	12.39	46.00	-33.61	AVG	
9		9.5100	22.60	9.69	32.29	60.00	-27.71	QP	
10		9.5100	18.84	9.69	28.53	50.00	-21.47	AVG	
11		29.8820	23.27	9.70	32.97	60.00	-27.03	QP	
12		29.8820	12.63	9.70	22.33	50.00	-27.67	AVG	



Temperature :	26 °C	Relative Humidity :	54%
Pressure :	101kPa	Phase :	N
Test Voltage :	DC 19V from adaptor(GSCU0600S019V12E) AC120V 60Hz	Test Mode :	Mode 5

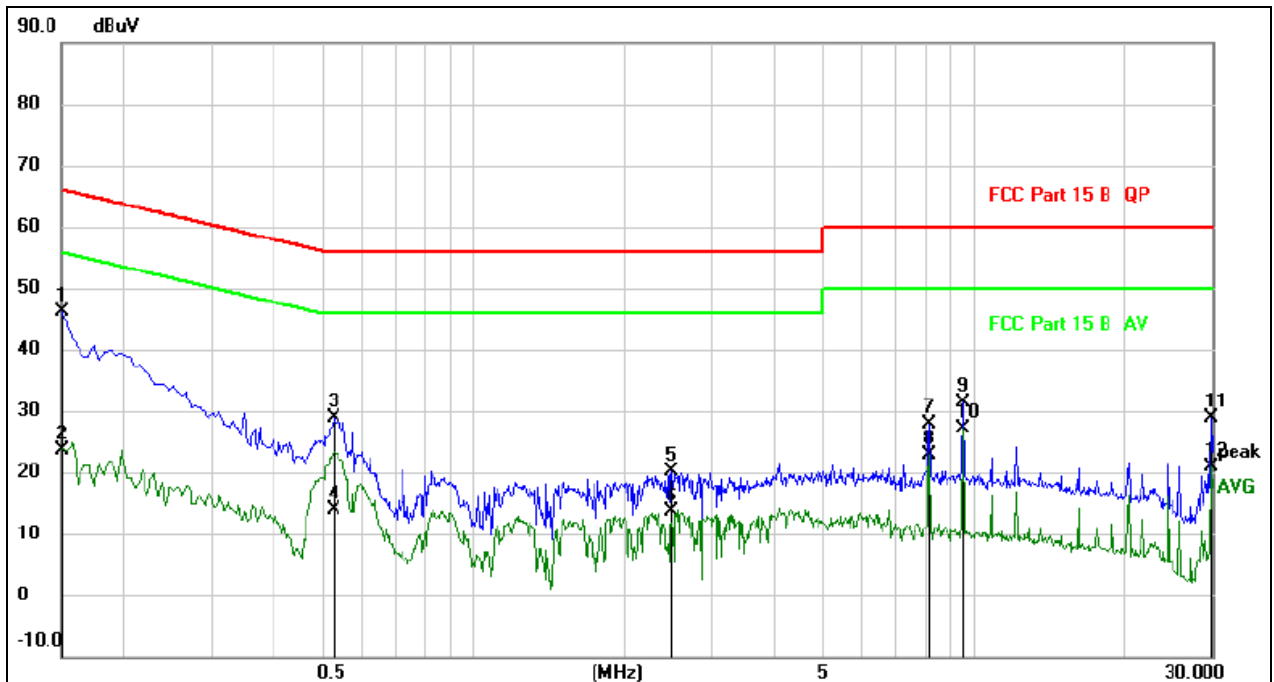

Remark:

1. All readings are Quasi-Peak and Average values.
2. Factor = Insertion Loss + Cable Loss.

No.	Mk.	Freq. MHz	Reading Level dBuV	Correct Factor	Measure- ment dBuV	Limit dBuV	Over dB	Detector	Comment
1	*	0.1500	36.64	9.52	46.16	66.00	-19.84	QP	
2		0.1500	14.05	9.52	23.57	56.00	-32.43	AVG	
3		0.5260	19.07	9.70	28.77	56.00	-27.23	QP	
4		0.5260	4.13	9.70	13.83	46.00	-32.17	AVG	
5		2.4980	10.40	9.62	20.02	56.00	-35.98	QP	
6		2.4980	4.13	9.62	13.75	46.00	-32.25	AVG	
7		8.1500	18.29	9.71	28.00	60.00	-32.00	QP	
8		8.1500	13.13	9.71	22.84	50.00	-27.16	AVG	
9		9.5060	21.63	9.69	31.32	60.00	-28.68	QP	
10		9.5060	17.33	9.69	27.02	50.00	-22.98	AVG	
11		29.8820	19.29	9.70	28.99	60.00	-31.01	QP	
12		29.8820	11.21	9.70	20.91	50.00	-29.09	AVG	

3.2 RADIATED EMISSION MEASUREMENT

3.2.1 RADIATED EMISSION LIMITS (Frequency Range 9kHz-1000MHz)

20dBc in any 100 kHz bandwidth outside the operating frequency band. In case the emission fall within the restricted band specified on 15.205(a), then the 15.209(a) limit in the table below has to be followed.

Frequencies (MHz)	Field Strength (micorvolts/meter)	Measurement Distance (meters)
0.009~0.490	2400/F(KHz)	300
0.490~1.705	24000/F(KHz)	30
1.705~30.0	30	30
30~88	100	3
88~216	150	3
216~960	200	3
Above 960	500	3

LIMITS OF RADIATED EMISSION MEASUREMENT (Above 1000MHz)

FREQUENCY (MHz)	Limit (dBuV/m) (at 3M)	
	PEAK	AVERAGE
Above 1000	74	54

Notes:

- (1) The limit for radiated test was performed according to FCC PART 15C.
- (2) The tighter limit applies at the band edges.
- (3) Emission level (dBuV/m)=20log Emission level (uV/m).

Spectrum Parameter	Setting
Attenuation	Auto
Start Frequency	1000 MHz
Stop Frequency	25GHz
RB / VB (emission in restricted band)	1 MHz / 1 MHz for Peak, 1 MHz / 10Hz for Average

Receiver Parameter	Setting
Attenuation	Auto
Start ~ Stop Frequency	9kHz~150kHz / RB 200Hz for QP
Start ~ Stop Frequency	150kHz~30MHz / RB 9kHz for QP
Start ~ Stop Frequency	30MHz~1000MHz / RB 120kHz for QP

3.2.2 TEST PROCEDURE

Below 1GHz test procedure as below:

- a. The EUT was placed on the top of a rotating table 0.1 meters above the ground at a 3 meter semi-anechoic chamber. The table was rotated 360 degrees to determine the position of the highest radiation.
- b. The EUT was set 3 meters away from the interference-receiving antenna, which was mounted on the top of a variable-height antenna tower.
- c. The antenna height is varied from one meter to four meters above the ground to determine the maximum value of the field strength. Both horizontal and vertical polarizations of the antenna are set to make the measurement.
- d. For each suspected emission, the EUT was arranged to its worst case and then the antenna was tuned to heights from 1 meter to 4 meters (for the test frequency of below 30MHz, the antenna was tuned to heights 1 meter) and the rotatable table was turned from 0 degrees to 360 degrees to find the maximum reading.
- e. The test-receiver system was set to Peak Detect Function and Specified Bandwidth with Maximum Hold Mode.
- f. If the emission level of the EUT in peak mode was 10dB lower than the limit specified, then testing could be stopped and the peak values of the EUT would be reported. Otherwise the emissions that did not have 10dB margin would be re-tested one by one using peak, quasi-peak or average method as specified and then reported in a data sheet.

Above 1GHz test procedure as below:

- g. Different between above is the test site, change from Semi- Anechoic Chamber to fully Anechoic Chamber and change form table 0.8 metre to 1.5 metre(Above 18GHz the distance is 1 meter and table is 1.5 metre).
- h. Test the EUT in the lowest channel ,the middle channel ,the Highest channel

Note:

Both horizontal and vertical antenna polarities were tested and performed pretest to three orthogonal axis. The worst case emissions were reported

3.2.3 DEVIATION FROM TEST STANDARD

No deviation

3.2.4 TEST SETUP

(A) Radiated Emission Test-Up Frequency Below 30MHz

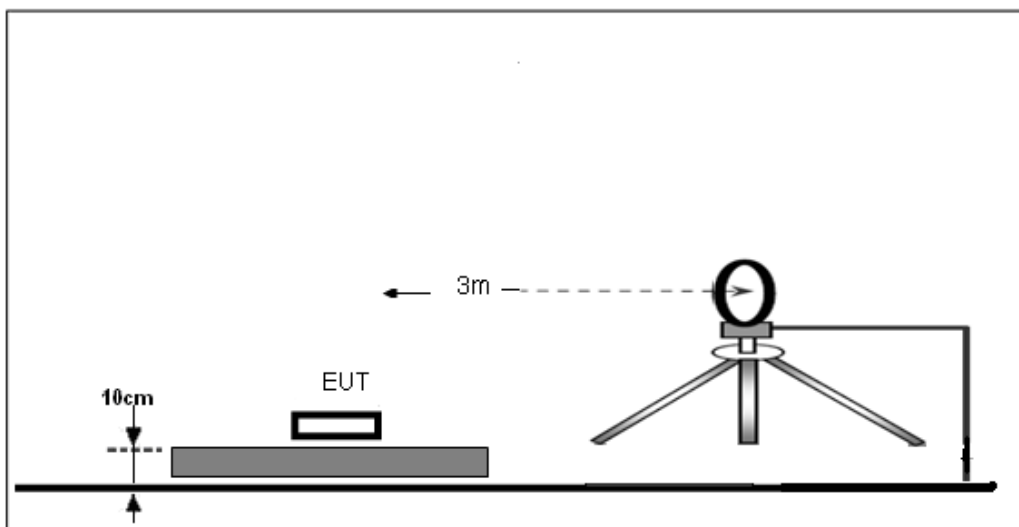

(B) Radiated Emission Test-Up Frequency 30MHz~1GHz

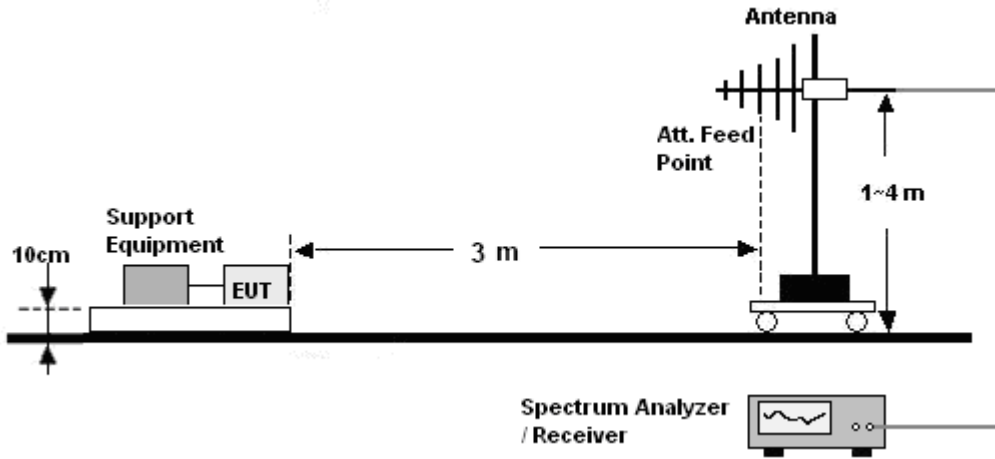

(C) Radiated Emission Test-Up Frequency Above 1GHz

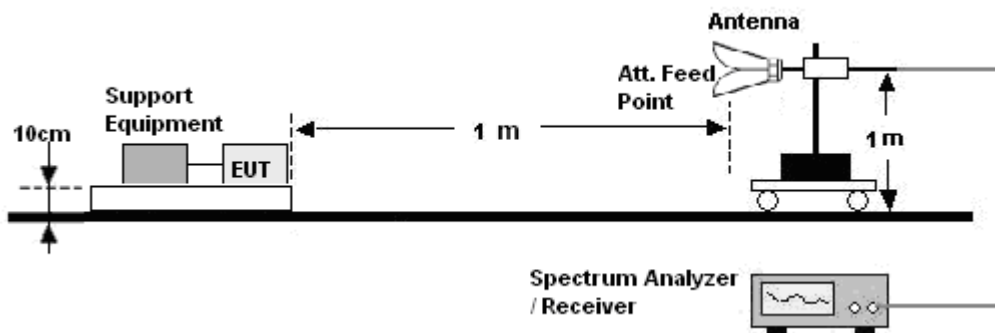

3.2.5 EUT OPERATING CONDITIONS

The EUT tested system was configured as the statements of 2.4 Unless otherwise a special operating condition is specified in the follows during the testing.

3.2.6 TEST RESULTS (BETWEEN 9KHZ – 30 MHZ)

Temperature:	26°C	Relative Humidity:	54%
Pressure:	101kPa	Test Voltage :	DC 14.52V
Test Mode :	Mode 5	Polarization :	--

Freq.	Reading	Limit	Margin	State
(MHz)	(dBuV/m)	(dBuV/m)	(dB)	P/F
--	--	--	--	PASS
--	--	--	--	PASS

NOTE:

The amplitude of spurious emissions which are attenuated by more than 20dB below the permissible value has no need to be reported.

Distance extrapolation factor = $40 \log(\text{specific distance}/\text{test distance})$ (dB);

Limit line = specific limits(dBuv) + distance extrapolation factor.

3.2.7 TEST RESULTS (BETWEEN 30MHZ – 1GHZ)

Temperature :	26℃	Relative Humidity :	54%
Pressure :	101 kPa	Polarization :	Horizontal
Test Voltage :	DC 19V from adaptor(GSCU0600S019V12E) AC120V 60Hz		
Test Mode :	Mode 5		

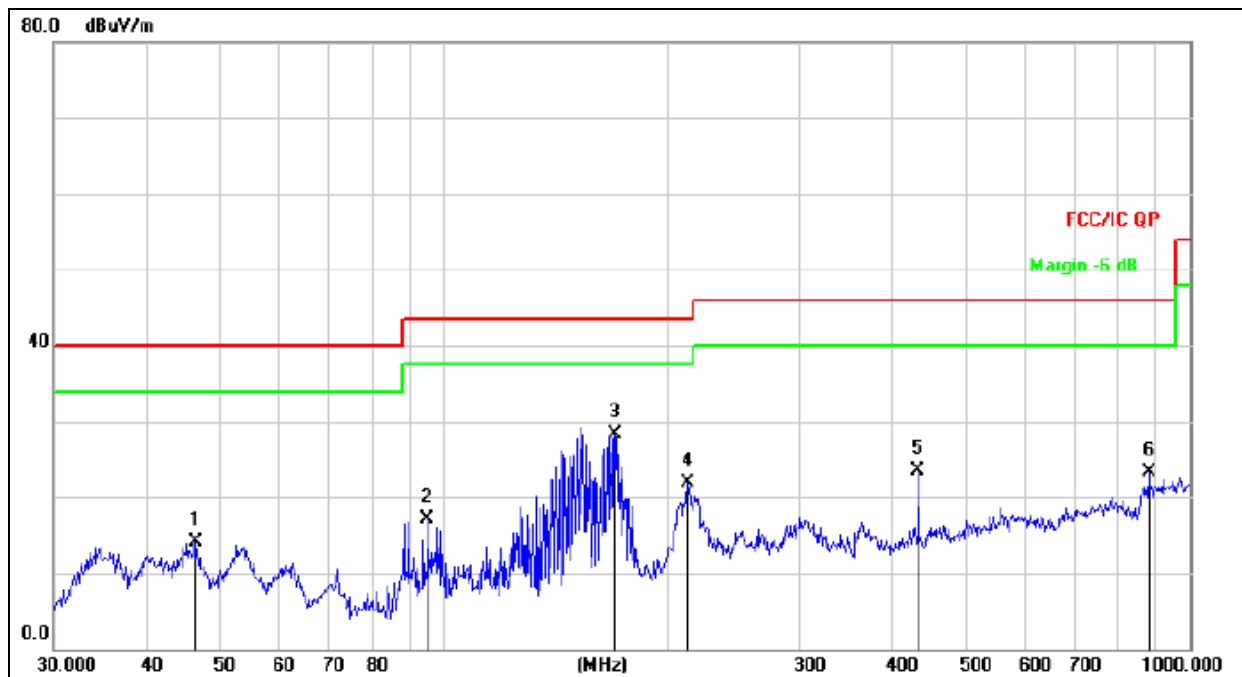

Remark:
Factor = Antenna Factor + Cable Loss – Pre-amplifier.

No.	Mk.	Freq. MHz	Reading Level dBuV	Correct Factor dB	Measure- ment dBuV/m	Limit dB/m	Over dB	Detector
1		46.3402	29.12	-15.05	14.07	40.00	-25.93	QP
2		95.0930	34.30	-17.17	17.13	43.50	-26.37	QP
3	*	169.5990	46.56	-18.25	28.31	43.50	-15.19	QP
4		212.2695	38.00	-16.02	21.98	43.50	-21.52	QP
5		432.5457	33.80	-10.36	23.44	46.00	-22.56	QP
6		881.4067	25.21	-1.88	23.33	46.00	-22.67	QP



Temperature :	26°C	Relative Humidity :	54%
Pressure :	101kPa	Polarization :	Vertical
Test Voltage :	DC 19V from adaptor(GSCU0600S019V12E) AC120V 60Hz		
Test Mode :	Mode 5		

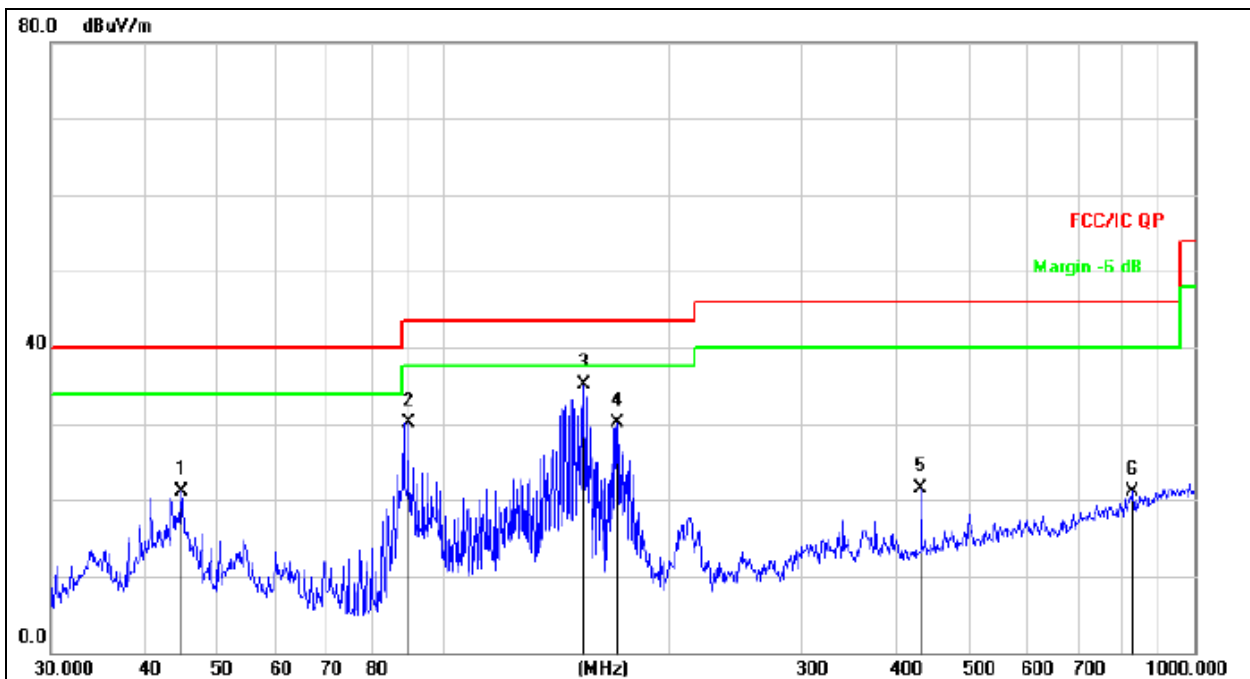

Remark:
Factor = Antenna Factor + Cable Loss – Pre-amplifier.

No.	Mk.	Freq. MHz	Reading Level dBuV	Correct Factor dB	Measure- ment dBuV/m	Limit dB/m	Over dB	Detector
1		44.7433	36.27	-15.14	21.13	40.00	-18.87	QP
2		89.5899	48.37	-18.19	30.18	43.50	-13.32	QP
3	*	153.7385	54.27	-19.26	35.01	43.50	-8.49	QP
4		170.1948	48.22	-18.21	30.01	43.50	-13.49	QP
5		432.5457	31.92	-10.36	21.56	46.00	-24.44	QP
6		827.4934	24.09	-3.02	21.07	46.00	-24.93	QP



Temperature :	26°C	Relative Humidity :	54%
Pressure :	101 kPa	Polarization :	Horizontal
Test Voltage :	DC 19V from adaptor(DK18-190060H-U) AC120V 60Hz		
Test Mode :	Mode 5		

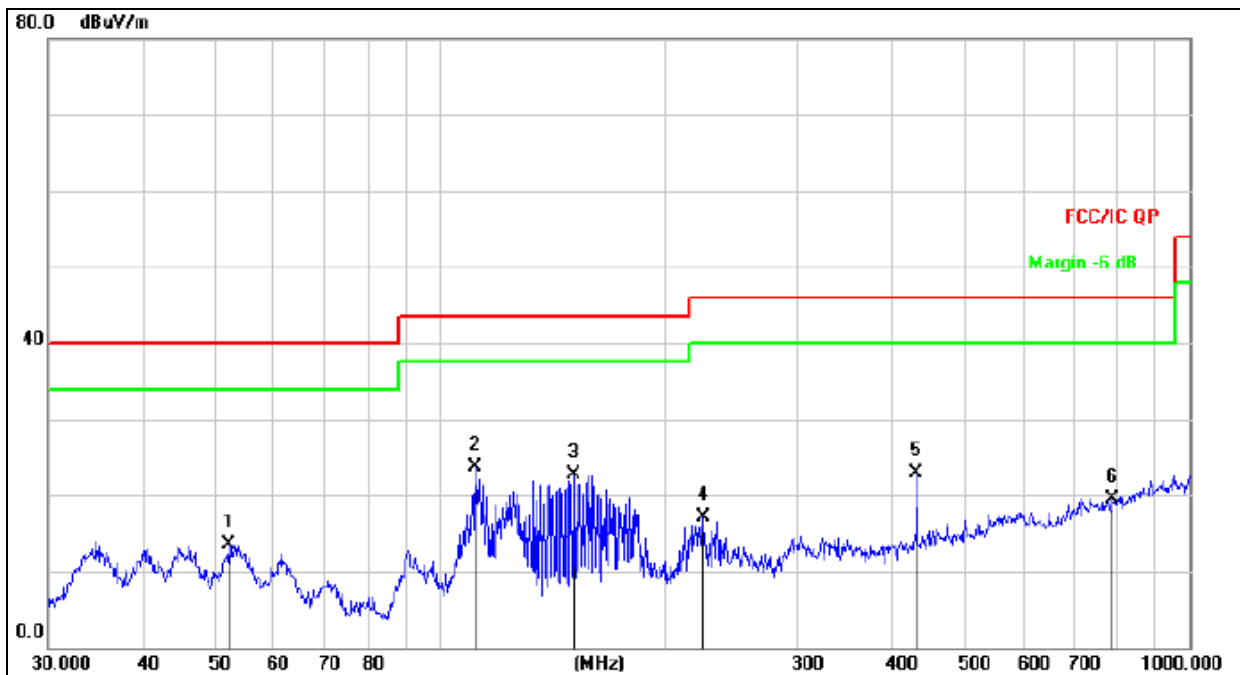

Remark:
Factor = Antenna Factor + Cable Loss – Pre-amplifier.

No.	Mk.	Freq. MHz	Reading Level dBuV	Correct Factor dB	Measure- ment dBuV/m	Limit dB/m	Over dB	Detector
1		52.2079	28.60	-15.08	13.52	40.00	-26.48	QP
2	*	111.3468	40.74	-17.01	23.73	43.50	-19.77	QP
3		151.0666	42.18	-19.43	22.75	43.50	-20.75	QP
4		224.5193	32.85	-15.74	17.11	46.00	-28.89	QP
5		432.5457	33.17	-10.36	22.81	46.00	-23.19	QP
6		790.6188	23.29	-3.77	19.52	46.00	-26.48	QP

Temperature :	26°C	Relative Humidity :	54%
Pressure :	101kPa	Polarization :	Vertical
Test Voltage :	DC 19V from adaptor(DK18-190060H-U) AC120V 60Hz		
Test Mode :	Mode 5		

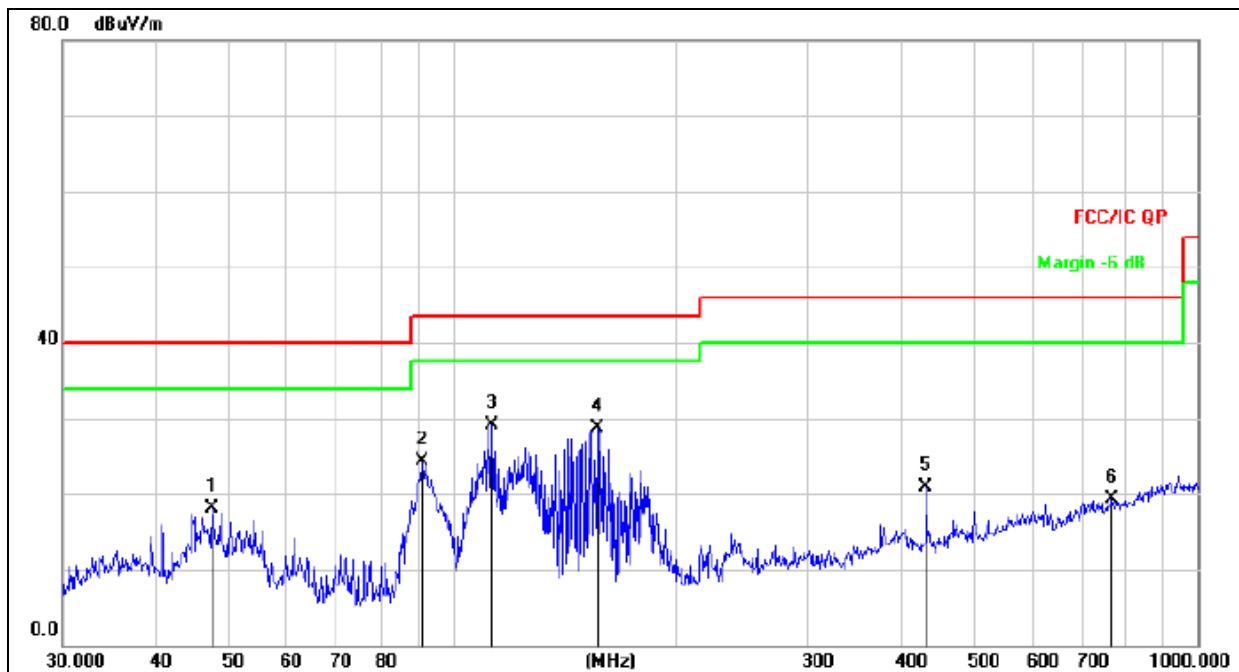

Remark:

Factor = Antenna Factor + Cable Loss – Pre-amplifier.

No.	Mk.	Freq. MHz	Reading Level dBuV	Correct Factor dB	Measure- ment dBuV/m	Limit dB/m	Over dB	Detector
1		47.4918	33.02	-14.99	18.03	40.00	-21.97	QP
2		91.1746	42.22	-17.89	24.33	43.50	-19.17	QP
3	*	112.9196	46.30	-17.11	29.19	43.50	-14.31	QP
4		156.4578	47.75	-19.09	28.66	43.50	-14.84	QP
5		432.5457	31.25	-10.36	20.89	46.00	-25.11	QP
6		768.7481	23.47	-4.08	19.39	46.00	-26.61	QP



Temperature :	26°C	Relative Humidity :	54%
Pressure :	101 kPa	Polarization :	Horizontal
Test Voltage :	DC 19V from adaptor(YJS015D-1900600U) AC120V 60Hz		
Test Mode :	Mode 5		

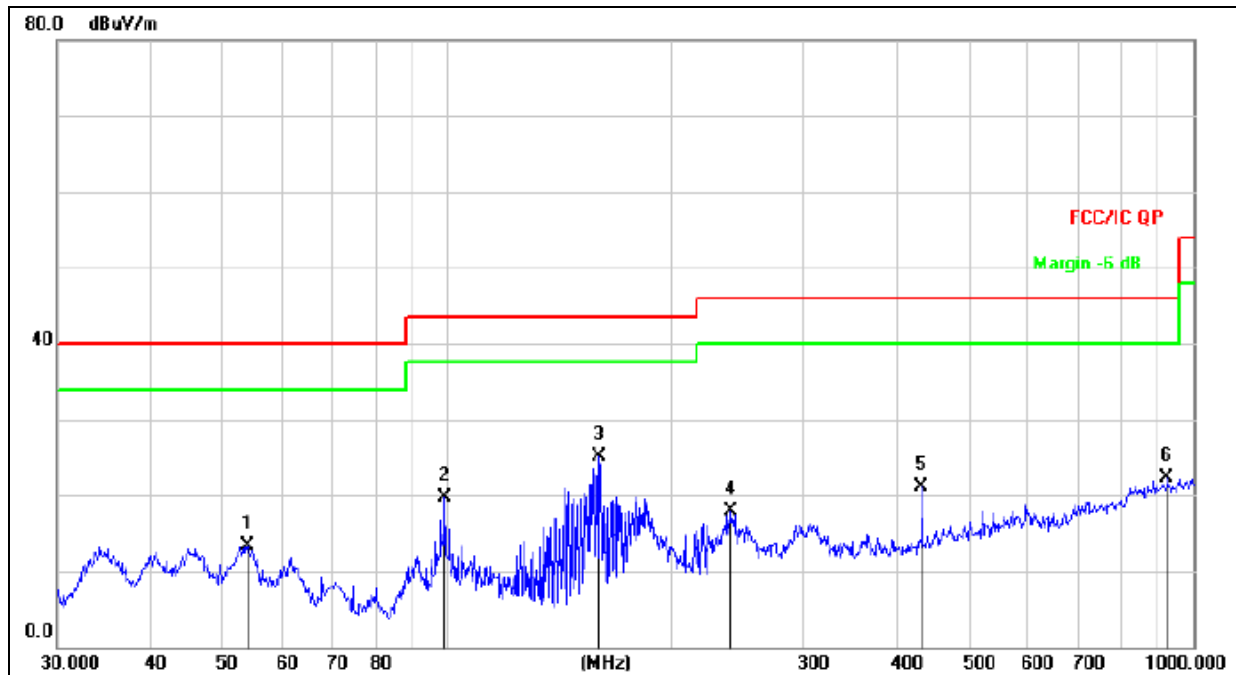

Remark:
Factor = Antenna Factor + Cable Loss – Pre-amplifier.

No.	Mk.	Freq. MHz	Reading Level dBuV	Correct Factor dB	Measure- ment dBuV/m	Limit dB/m	Over dB	Detector
1		53.8818	28.53	-15.26	13.27	40.00	-26.73	QP
2		99.1797	36.22	-16.43	19.79	43.50	-23.71	QP
3	*	159.2251	43.96	-18.91	25.05	43.50	-18.45	QP
4		239.1473	33.24	-15.40	17.84	46.00	-28.16	QP
5		432.5457	31.53	-10.36	21.17	46.00	-24.83	QP
6		922.5157	23.64	-1.32	22.32	46.00	-23.68	QP

Temperature :	26°C	Relative Humidity :	54%
Pressure :	101kPa	Polarization :	Vertical
Test Voltage :	DC 19V from adaptor(YJS015D-1900600U) AC120V 60Hz		
Test Mode :	Mode 5		

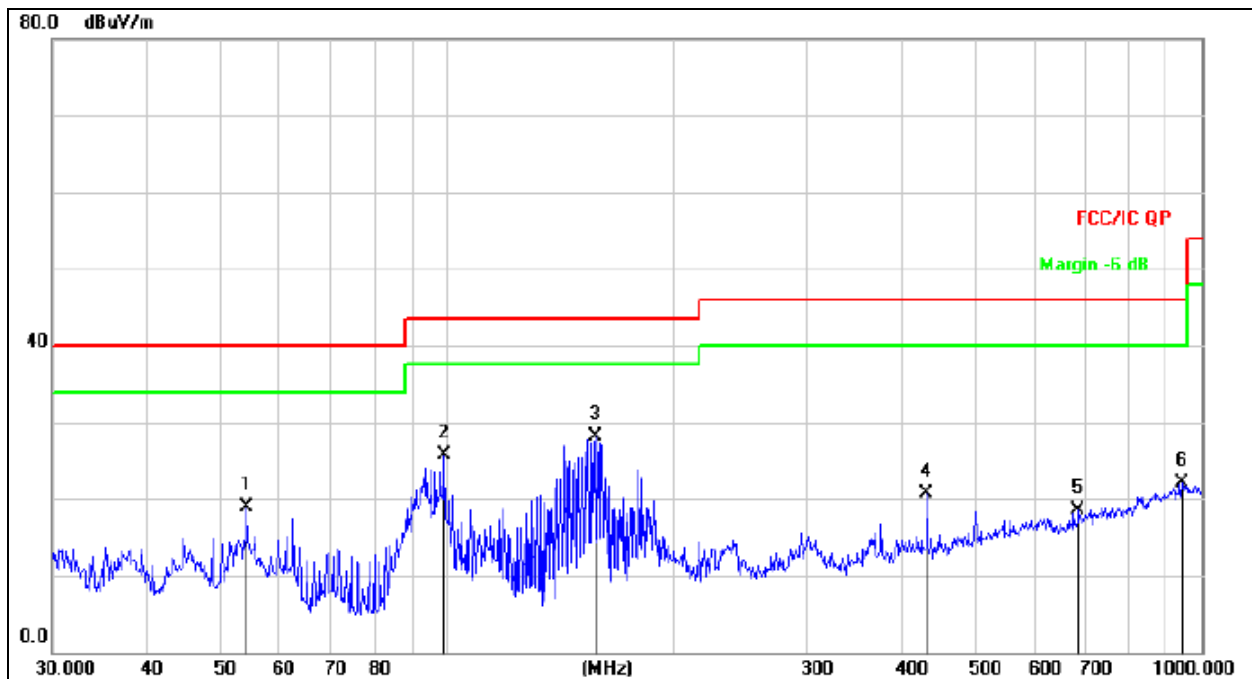

Remark:
Factor = Antenna Factor + Cable Loss – Pre-amplifier.

No.	Mk.	Freq.	Reading Level	Correct Factor	Measurement	Limit	Over	Detector
		MHz	dBuV	dB	dBuV/m	dB/m	dB	
1		54.2610	34.23	-15.30	18.93	40.00	-21.07	QP
2		99.1797	42.07	-16.43	25.64	43.50	-17.86	QP
3	*	157.5588	47.22	-19.02	28.20	43.50	-15.30	QP
4		432.5457	31.04	-10.36	20.68	46.00	-25.32	QP
5		687.1507	24.05	-5.57	18.48	46.00	-27.52	QP
6		942.1305	23.20	-1.17	22.03	46.00	-23.97	QP



Temperature :	26°C	Relative Humidity :	54%
Pressure :	101 kPa	Polarization :	Horizontal
Test Voltage :	DC 14.52V		
Test Mode :	Mode 5		

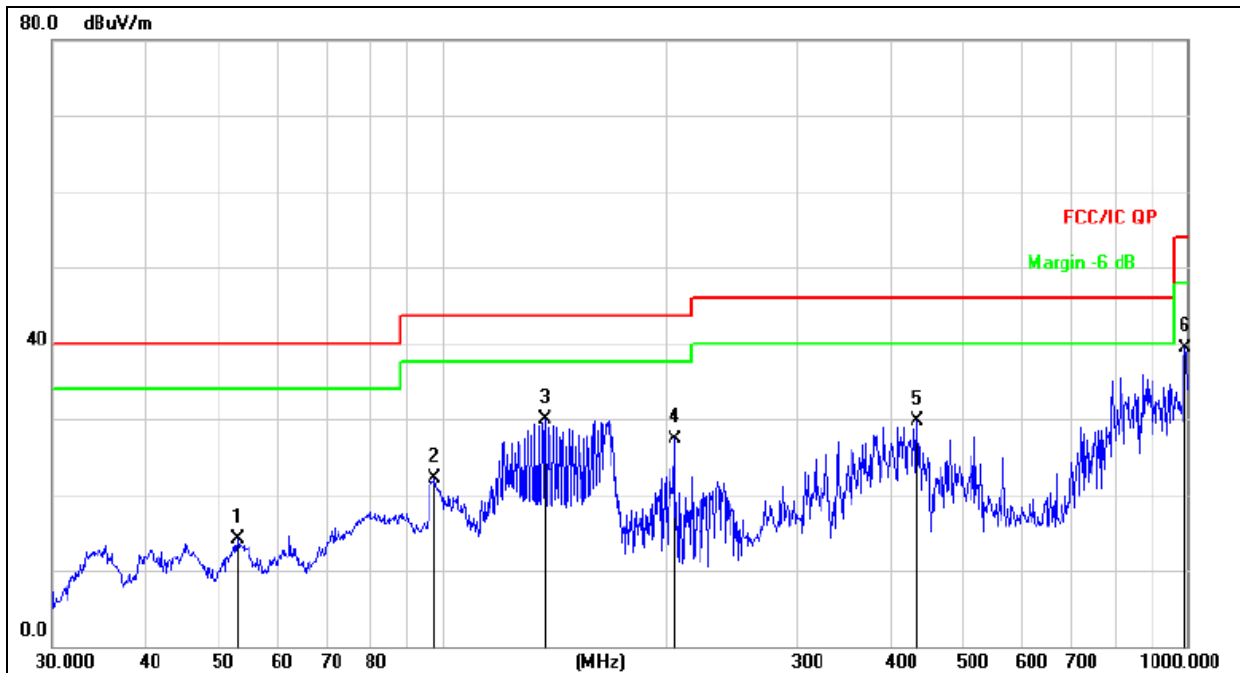

Remark:
Factor = Antenna Factor + Cable Loss – Pre-amplifier.

No.	Mk.	Freq. MHz	Reading Level dBuV	Correct Factor dB	Measure- ment dBuV/m	Limit dB/m	Over dB	Detector
1		53.1313	29.21	-15.18	14.03	40.00	-25.97	QP
2		97.7983	38.87	-16.68	22.19	43.50	-21.31	QP
3	*	137.4202	48.64	-18.69	29.95	43.50	-13.55	QP
4		204.9551	43.51	-16.19	27.32	43.50	-16.18	QP
5		434.0651	40.08	-10.33	29.75	46.00	-16.25	QP
6		993.0114	40.24	-0.85	39.39	54.00	-14.61	QP



Temperature :	26°C	Relative Humidity :	54%
Pressure :	101 kPa	Polarization :	Vertical
Test Voltage :	DC 14.52V		
Test Mode :	Mode 5		

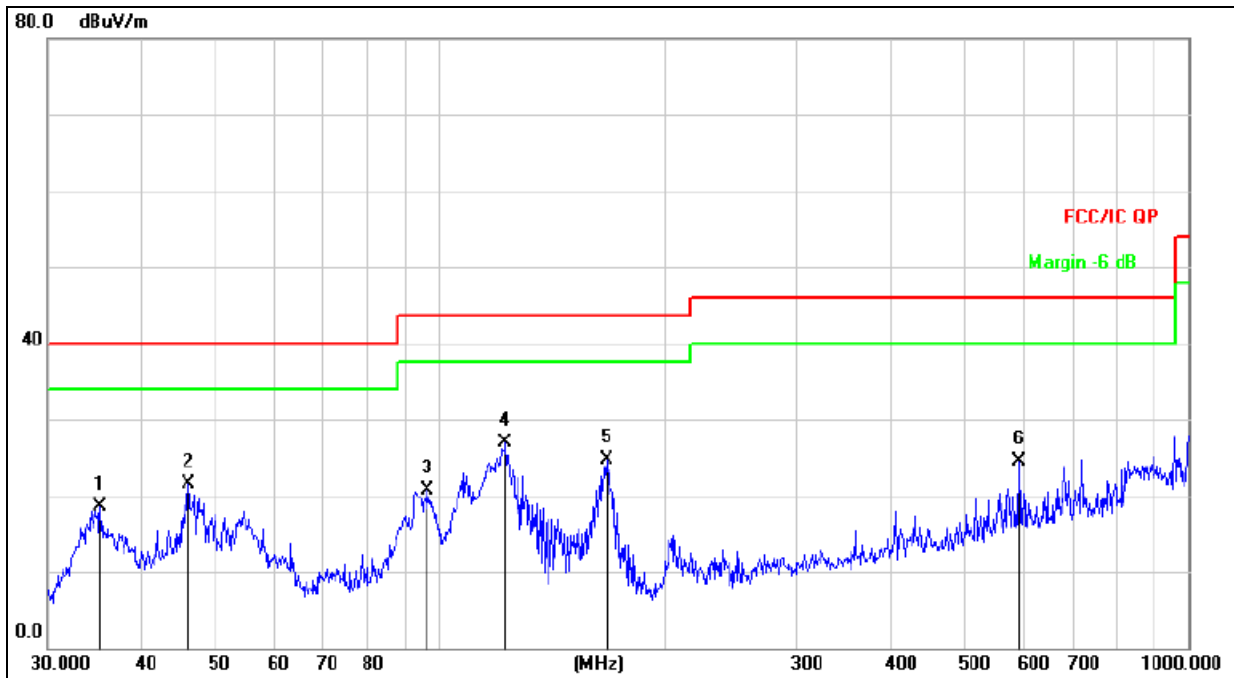

Remark:
Factor = Antenna Factor + Cable Loss – Pre-amplifier.

No.	Mk.	Freq.	Reading Level	Correct Factor	Measurement	Limit	Over	Detector
		MHz	dBuV	dB	dBuV/m	dB/m	dB	
1		35.2512	34.77	-16.30	18.47	40.00	-21.53	QP
2		46.1779	36.65	-15.06	21.59	40.00	-18.41	QP
3		96.4362	37.64	-16.93	20.71	43.50	-22.79	QP
4	*	122.4040	44.55	-17.72	26.83	43.50	-16.67	QP
5		167.2368	43.16	-18.40	24.76	43.50	-18.74	QP
6		593.0497	31.24	-6.68	24.56	46.00	-21.44	QP

3.2.8 TEST RESULTS (1GHZ~25GHZ)
802.11b

Polar (H/V)	Frequency	Meter Reading	Pre-amplifier	Cable Loss	Antenna Factor	Emission Level	Limits	Margin	Detector Type
	(MHz)	(dBuV)	(dB)	(dB)	(dB)	(dBuV/m)	(dBuV/m)	(dB)	
Low Channel:2412MHz									
V	4824.00	50.26	39.55	7.85	25.66	44.22	74.00	-29.78	PK
V	4824.00	43.45	39.55	7.85	25.66	37.41	54.00	-16.59	AV
V	7236.00	52.57	38.33	7.52	24.55	46.31	74.00	-27.69	PK
V	7236.00	43.55	38.33	7.52	24.55	37.29	54.00	-16.71	AV
V	15450.00	52.64	35.23	6.75	26.59	50.75	74.00	-23.25	PK
H	4824.00	53.14	39.55	7.85	25.66	47.10	74.00	-26.90	PK
H	4824.00	43.23	39.55	7.85	25.66	37.19	54.00	-16.81	AV
H	7236.00	54.12	38.33	7.52	23.55	46.86	74.00	-27.14	PK
H	7236.00	43.30	38.33	7.52	23.22	35.71	54.00	-18.29	AV
H	15450.00	53.96	35.45	6.75	27.88	53.14	74.00	-20.86	PK

Polar (H/V)	Frequency	Meter Reading	Pre-amplifier	Cable Loss	Antenna Factor	Emission Level	Limits	Margin	Detector Type
	(MHz)	(dBuV)	(dB)	(dB)	(dB)	(dBuV/m)	(dBuV/m)	(dB)	
Middle Channel:2437MHz									
V	4874.00	54.84	39.55	7.85	25.66	48.80	74.00	-25.20	Pk
V	4874.00	43.84	39.55	7.85	25.66	37.80	54.00	-16.20	AV
V	7311.00	51.62	38.33	7.52	24.55	45.36	74.00	-28.64	Pk
V	7311.00	43.56	38.33	7.52	24.55	37.30	54.00	-16.70	AV
V	15450.00	51.49	35.23	6.75	26.59	49.60	74.00	-24.40	Pk
H	4874.00	53.49	39.55	7.85	25.66	47.45	74.00	-26.55	Pk
H	4874.00	43.38	39.55	7.85	25.66	37.34	54.00	-16.66	AV
H	7311.00	51.24	38.33	7.52	23.55	43.98	74.00	-30.02	Pk
H	7311.00	43.08	38.33	7.52	23.22	35.49	54.00	-18.51	AV
H	15450.00	50.99	35.45	6.75	27.88	50.17	74.00	-23.83	Pk

Polar (H/V)	Frequency	Meter Reading	Pre-amplifier	Cable Loss	Antenna Factor	Emission Level	Limits	Margin	Detector Type
	(MHz)	(dBuV)	(dB)	(dB)	(dB)	(dBuV/m)	(dBuV/m)	(dB)	
High Channel: 2462MHz									
V	4924.00	50.34	39.55	7.85	25.66	44.30	74.00	-29.70	PK
V	4924.00	43.32	39.55	7.85	25.66	37.28	54.00	-16.72	AV
V	7386.00	51.55	38.33	7.52	24.55	45.29	74.00	-28.71	PK
V	7386.00	43.02	38.33	7.52	24.55	36.76	54.00	-17.24	AV
V	15450.00	53.63	35.23	6.75	26.59	51.74	74.00	-22.26	PK
H	4924.00	51.00	39.55	7.85	25.66	44.96	74.00	-29.04	PK
H	4924.00	43.91	39.55	7.85	25.66	37.87	54.00	-16.13	AV
H	7386.00	51.68	38.33	7.52	23.55	44.42	74.00	-29.58	PK
H	7386.00	43.83	38.33	7.52	23.22	36.24	54.00	-17.76	AV
H	15450.00	52.74	35.45	6.75	27.88	51.92	74.00	-22.08	PK

Remark:

1. Emission Level = Meter Reading + Antenna Factor + Cable Loss – Pre-amplifier,

Margin= Emission Level - Limit

2. If peak below the average limit, the average emission was no test.

3. The amplitude of spurious emissions which are attenuated by more than 20dB below the permissible value has no need to be reported.

802.11g

Polar (H/V)	Frequency	Meter Reading	Pre-amplifier	Cable Loss	Antenna Factor	Emission Level	Limits	Margin	Detector Type
	(MHz)	(dBuV)	(dB)	(dB)	(dB)	(dBuV/m)	(dBuV/m)	(dB)	
Low Channel:2412MHz									
V	4824.00	52.54	39.55	7.85	25.66	46.50	74.00	-27.50	PK
V	4824.00	43.65	39.55	7.85	25.66	37.61	54.00	-16.39	AV
V	7236.00	54.07	38.33	7.52	24.55	47.81	74.00	-26.19	PK
V	7236.00	43.91	38.33	7.52	24.55	37.65	54.00	-16.35	AV
V	15450.00	51.86	35.23	6.75	26.59	49.97	74.00	-24.03	PK
H	4824.00	54.63	39.55	7.85	25.66	48.59	74.00	-25.41	PK
H	4824.00	43.57	39.55	7.85	25.66	37.53	54.00	-16.47	AV
H	7236.00	54.06	38.33	7.52	23.55	46.80	74.00	-27.20	PK
H	7236.00	43.67	38.33	7.52	23.22	36.08	54.00	-17.92	AV
H	15450.00	50.54	35.45	6.75	27.88	49.72	74.00	-24.28	PK

Polar (H/V)	Frequency	Meter Reading	Pre-amplifier	Cable Loss	Antenna Factor	Emission Level	Limits	Margin	Detector Type
	(MHz)	(dBuV)	(dB)	(dB)	(dB)	(dBuV/m)	(dBuV/m)	(dB)	
Middle Channel:2437MHz									
V	4874.00	54.70	39.55	7.85	25.66	48.66	74.00	-25.34	PK
V	4874.00	43.37	39.55	7.85	25.66	37.33	54.00	-16.67	AV
V	7311.00	52.24	38.33	7.52	24.55	45.98	74.00	-28.02	PK
V	7311.00	43.47	38.33	7.52	24.55	37.21	54.00	-16.79	AV
V	15450.00	54.29	35.23	6.75	26.59	52.40	74.00	-21.60	PK
H	4874.00	53.50	39.55	7.85	25.66	47.46	74.00	-26.54	PK
H	4874.00	43.38	39.55	7.85	25.66	37.34	54.00	-16.66	AV
H	7311.00	53.84	38.33	7.52	23.55	46.58	74.00	-27.42	PK
H	7311.00	43.28	38.33	7.52	23.22	35.69	54.00	-18.31	AV
H	15450.00	52.21	35.45	6.75	27.88	51.39	74.00	-22.61	PK

Polar (H/V)	Frequency	Meter Reading	Pre-amplifier	Cable Loss	Antenna Factor	Emission Level	Limits	Margin	Detector Type
	(MHz)	(dBuV)	(dB)	(dB)	(dB)	(dBuV/m)	(dBuV/m)	(dB)	
High Channel: 2462MHz									
V	4924.00	53.61	39.55	7.85	25.66	47.57	74.00	-26.43	PK
V	4924.00	43.20	39.55	7.85	25.66	37.16	54.00	-16.84	AV
V	7386.00	53.09	38.33	7.52	24.55	46.83	74.00	-27.17	PK
V	7386.00	43.48	38.33	7.52	24.55	37.22	54.00	-16.78	AV
V	15450.00	51.16	35.23	6.75	26.59	49.27	74.00	-24.73	PK
H	4924.00	54.69	39.55	7.85	25.66	48.65	74.00	-25.35	PK
H	4924.00	43.64	39.55	7.85	25.66	37.60	54.00	-16.40	AV
H	7386.00	51.70	38.33	7.52	23.55	44.44	74.00	-29.56	PK
H	7386.00	43.82	38.33	7.52	23.22	36.23	54.00	-17.77	AV
H	15450.00	54.34	35.45	6.75	27.88	53.52	74.00	-20.48	PK

Remark:

1. Emission Level = Meter Reading + Antenna Factor + Cable Loss – Pre-amplifier,

Margin= Emission Level - Limit

2. If peak below the average limit, the average emission was no test.

3. The amplitude of spurious emissions which are attenuated by more than 20dB below the permissible value has no need to be reported.

802.11n(20MHz)

Polar (H/V)	Frequency	Meter Reading	Pre-amplifier	Cable Loss	Antenna Factor	Emission Level	Limits	Margin	Detector Type
	(MHz)	(dBuV)	(dB)	(dB)	(dB)	(dBuV/m)	(dBuV/m)	(dB)	
Low Channel:2412MHz									
V	4824.00	54.48	39.55	7.85	25.66	48.44	74.00	-25.56	PK
V	4824.00	43.09	39.55	7.85	25.66	37.05	54.00	-16.95	AV
V	7236.00	53.14	38.33	7.52	24.55	46.88	74.00	-27.12	PK
V	7236.00	43.52	38.33	7.52	24.55	37.26	54.00	-16.74	AV
V	15450.00	50.20	35.23	6.75	26.59	48.31	74.00	-25.69	PK
H	4824.00	50.88	39.55	7.85	25.66	44.84	74.00	-29.16	PK
H	4824.00	43.27	39.55	7.85	25.66	37.23	54.00	-16.77	AV
H	7236.00	54.82	38.33	7.52	23.55	47.56	74.00	-26.44	PK
H	7236.00	43.28	38.33	7.52	23.22	35.69	54.00	-18.31	AV
H	15450.00	54.04	35.45	6.75	27.88	53.22	74.00	-20.78	PK

Polar (H/V)	Frequency	Meter Reading	Pre-amplifier	Cable Loss	Antenna Factor	Emission Level	Limits	Margin	Detector Type
	(MHz)	(dBuV)	(dB)	(dB)	(dB)	(dBuV/m)	(dBuV/m)	(dB)	
Middle Channel:2437MHz									
V	4874.00	51.26	39.55	7.85	25.66	45.22	74.00	-28.78	PK
V	4874.00	43.78	39.55	7.85	25.66	37.74	54.00	-16.26	AV
V	7311.00	50.74	38.33	7.52	24.55	44.48	74.00	-29.52	PK
V	7311.00	43.79	38.33	7.52	24.55	37.53	54.00	-16.47	AV
V	15450.00	51.86	35.23	6.75	26.59	49.97	74.00	-24.03	PK
H	4874.00	50.27	39.55	7.85	25.66	44.23	74.00	-29.77	PK
H	4874.00	43.30	39.55	7.85	25.66	37.26	54.00	-16.74	AV
H	7311.00	52.14	38.33	7.52	23.55	44.88	74.00	-29.12	PK
H	7311.00	43.49	38.33	7.52	23.22	35.90	54.00	-18.10	AV
H	15450.00	53.24	35.45	6.75	27.88	52.42	74.00	-21.58	PK

Polar (H/V)	Frequency	Meter Reading	Pre-amplifier	Cable Loss	Antenna Factor	Emission Level	Limits	Margin	Detector Type
	(MHz)	(dBuV)	(dB)	(dB)	(dB)	(dBuV/m)	(dBuV/m)	(dB)	
High Channel: 2462MHz									
V	4924.00	53.70	39.55	7.85	25.66	47.66	74.00	-26.34	PK
V	4924.00	43.31	39.55	7.85	25.66	37.27	54.00	-16.73	AV
V	7386.00	51.95	38.33	7.52	24.55	45.69	74.00	-28.31	PK
V	7386.00	43.81	38.33	7.52	24.55	37.55	54.00	-16.45	AV
V	15450.00	50.21	35.23	6.75	26.59	48.32	74.00	-25.68	PK
H	4924.00	53.63	39.55	7.85	25.66	47.59	74.00	-26.41	PK
H	4924.00	43.54	39.55	7.85	25.66	37.50	54.00	-16.50	AV
H	7386.00	53.42	38.33	7.52	23.55	46.16	74.00	-27.84	PK
H	7386.00	43.60	38.33	7.52	23.22	36.01	54.00	-17.99	AV
H	15450.00	53.37	35.45	6.75	27.88	52.55	74.00	-21.45	PK

Remark:

1. Emission Level = Meter Reading + Antenna Factor + Cable Loss – Pre-amplifier,

Margin= Emission Level - Limit

2. If peak below the average limit, the average emission was no test.

3. The amplitude of spurious emissions which are attenuated by more than 20dB below the permissible value has no need to be reported.

802.11n(40MHz)

Polar (H/V)	Frequency	Meter Reading	Pre-amplifier	Cable Loss	Antenna Factor	Emission Level	Limits	Margin	Detector Type
	(MHz)	(dBuV)	(dB)	(dB)	(dB)	(dBuV/m)	(dBuV/m)	(dB)	
Low Channel:2422MHz									
V	4844.00	52.07	39.55	7.57	25.45	45.54	74.00	-28.46	Pk
V	4844.00	43.67	39.55	7.57	25.45	37.14	54.00	-16.86	AV
V	7266.00	54.44	38.33	7.35	24.78	48.24	74.00	-25.76	Pk
V	7266.00	43.67	38.33	7.35	24.78	37.47	54.00	-16.53	AV
V	15450.00	51.31	35.23	6.42	26.47	48.97	74.00	-25.03	Pk
H	4844.00	51.00	35.23	6.42	26.47	48.66	74.00	-25.34	Pk
H	4844.00	43.41	39.55	7.57	25.45	36.88	54.00	-17.12	AV
H	7266.00	50.50	39.55	7.57	25.45	43.97	74.00	-30.03	Pk
H	7266.00	43.81	38.33	7.35	24.78	37.61	54.00	-16.39	AV
H	15450.00	52.67	35.23	6.42	26.47	50.33	74.00	-23.67	Pk

Polar (H/V)	Frequency	Meter Reading	Pre-amplifier	Cable Loss	Antenna Factor	Emission Level	Limits	Margin	Detector Type
	(MHz)	(dBuV)	(dB)	(dB)	(dB)	(dBuV/m)	(dBuV/m)	(dB)	
Middle Channel:2437MHz									
V	4874.00	50.17	39.55	7.57	25.45	43.64	74.00	-30.36	PK
V	4874.00	43.91	39.55	7.57	25.45	37.38	54.00	-16.62	AV
V	7311.00	50.09	38.33	7.35	24.78	43.89	74.00	-30.11	PK
V	7311.00	43.26	38.33	7.35	24.78	37.06	54.00	-16.94	AV
V	15450.00	53.29	35.23	6.42	26.47	50.95	74.00	-23.05	PK
H	4874.00	50.39	35.23	6.42	26.47	48.05	74.00	-25.95	PK
H	4874.00	43.34	39.55	7.57	25.45	36.81	54.00	-17.19	AV
H	7311.00	53.73	39.55	7.57	25.45	47.20	74.00	-26.80	PK
H	7311.00	43.46	38.33	7.35	24.78	37.26	54.00	-16.74	AV
H	15450.00	50.15	35.23	6.42	26.47	47.81	74.00	-26.19	PK

Polar (H/V)	Frequency	Meter Reading	Pre-amplifier	Cable Loss	Antenna Factor	Emission Level	Limits	Margin	Detector Type
	(MHz)	(dBuV)	(dB)	(dB)	(dB)	(dBuV/m)	(dBuV/m)	(dB)	
High Channel: 2452MHz									
V	4904.00	51.67	39.55	7.57	25.45	45.14	74.00	-28.86	PK
V	4904.00	43.77	39.55	7.57	25.45	37.24	54.00	-16.76	AV
V	7356.00	52.95	38.33	7.35	24.78	46.75	74.00	-27.25	PK
V	7356.00	43.96	38.33	7.35	24.78	37.76	54.00	-16.24	AV
V	15450.00	52.09	35.23	6.42	26.47	49.75	74.00	-24.25	PK
H	4904.00	54.73	35.23	6.42	26.47	52.39	74.00	-21.61	PK
H	4904.00	43.46	39.55	7.57	25.45	36.93	54.00	-17.07	AV
H	7356.00	50.48	39.55	7.57	25.45	43.95	74.00	-30.05	PK
H	7356.00	43.27	38.33	7.35	24.78	37.07	54.00	-16.93	AV
H	15450.00	51.63	35.23	6.42	26.47	49.29	74.00	-24.71	PK

Remark:

1. Emission Level = Meter Reading + Antenna Factor + Cable Loss – Pre-amplifier,

Margin= Emission Level - Limit

2. If peak below the average limit, the average emission was no test.

3. The amplitude of spurious emissions which are attenuated by more than 20dB below the permissible value has no need to be reported.

3.3 RADIATED BAND EMISSION MEASUREMENT

3.3.1 TEST REQUIREMENT:

FCC Part15 C Section 15.209 and 15.205

LIMITS OF RADIATED EMISSION MEASUREMENT (Above 1000MHz)

FREQUENCY (MHz)	Class B (dBuV/m) (at 3M)	
	PEAK	AVERAGE
Above 1000	74	54

Notes:

- (1) The limit for radiated test was performed according to FCC PART 15C.
- (2) The tighter limit applies at the band edges.
- (3) Emission level (dBuV/m)=20log Emission level (uV/m).

Spectrum Parameter	Setting
Attenuation	Auto
Start Frequency	2300MHz
Stop Frequency	2520
RB / VB (emission in restricted band)	1 MHz / 1 MHz for Peak, 1 MHz / 10Hz for Average

3.3.2 TEST PROCEDURE

Above 1GHz test procedure as below:

- a. 1. The EUT was placed on the top of a rotating table 1.5 meters above the ground at a 3 meter camber. The table was rotated 360 degrees to determine the position of the highest radiation.
- b. The EUT was set 3 meters away from the interference-receiving antenna, which was mounted on the top of a variable-height antenna tower.
- c. The antenna height is varied from one meter to four meters above the ground to determine the maximum value of the field strength. Both horizontal and vertical polarizations of the antenna are set to make the measurement.
- d. For each suspected emission, the EUT was arranged to its worst case and then the antenna was tuned to heights from 1 meter to 4 meters and the rota table was turned from 0 degrees to 360 degrees to find the maximum reading.
- e. The test-receiver system was set to Peak Detect Function and Specified Bandwidth with Maximum Hold Mode.
- f. If the emission level of the EUT in peak mode was 10dB lower than the limit specified, then testing could be stopped and the peak values of the EUT would be reported. Otherwise the emissions that did not have 10dB margin would be re-tested one by one using peak, quasi-peak or average method as specified and then reported in a data sheet.
- g. Test the EUT in the lowest channel, the Highest channel

Note:

Both horizontal and vertical antenna polarities were tested and performed pretest to three orthogonal axis. The worst case emissions were reported

3.3.3 DEVIATION FROM TEST STANDARD

No deviation

3.3.4 TEST SETUP

Radiated Emission Test-Up Frequency Above 1GHz

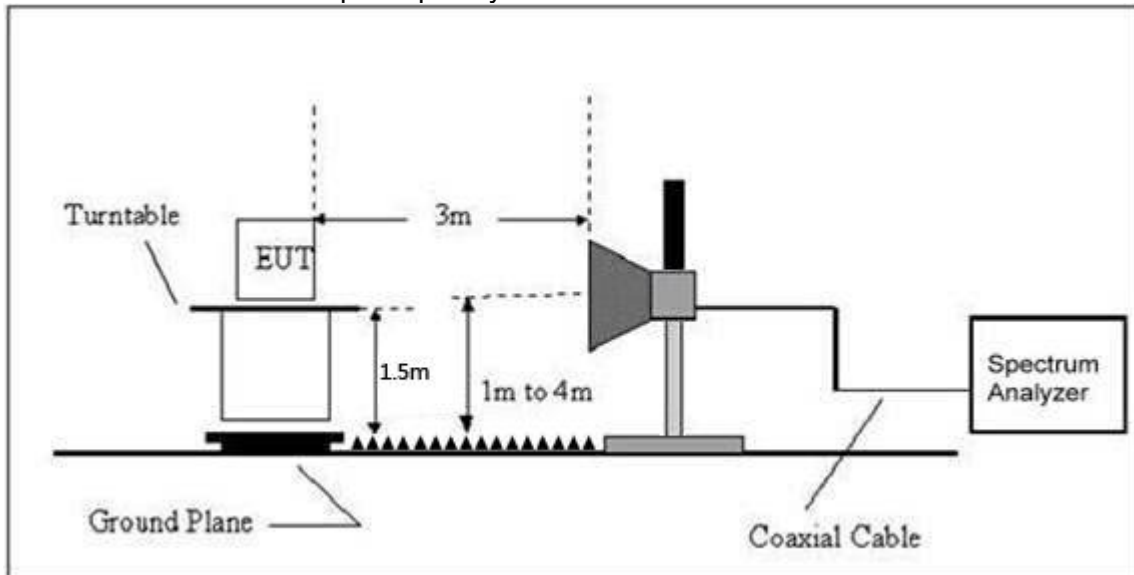

3.3.5 EUT OPERATING CONDITIONS

The EUT tested system was configured as the statements of 2.3 Unless otherwise a special operating condition is specified in the follows during the testing.



3.3.6 TEST RESULT

	Polar (H/V)	Frequency (MHz)	Meter Reading (dBuV)	Pre-amplifier (dB)	Cable Loss (dB)	Antenna Factor (dB/m)	Emission level (dBuV/m)	Limits (dBuV/m)		Result	
							PK	PK	AV		
802.11b	Low Channel 2412MHz										
	H	2390.00	64.36	38.06	7.42	20.15	53.87	74.00	54.00	PASS	
	H	2400.00	53.95	38.06	7.42	20.15	43.46	74.00	54.00	PASS	
	V	2390.00	61.70	38.06	7.42	20.15	51.21	74.00	54.00	PASS	
	V	2400.00	54.55	38.06	7.42	20.15	44.06	74.00	54.00	PASS	
	High Channel 2462MHz										
	H	2483.50	64.02	38.17	7.45	20.54	53.84	74.00	54.00	PASS	
	H	2485.50	52.81	38.17	7.45	20.54	42.63	74.00	54.00	PASS	
	V	2483.50	60.79	38.2	7.45	20.54	50.58	74.00	54.00	PASS	
	V	2485.50	52.82	38.2	7.45	20.54	42.61	74.00	54.00	PASS	
	802.11g	Low Channel 2412MHz									
		H	2390.00	61.14	38.06	7.42	20.15	50.65	74.00	54.00	PASS
H		2400.00	55.47	38.06	7.42	20.15	44.98	74.00	54.00	PASS	
V		2390.00	59.96	38.06	7.42	20.15	49.47	74.00	54.00	PASS	
V		2400.00	52.19	38.06	7.42	20.15	41.70	74.00	54.00	PASS	
High Channel 2462MHz											
H		2483.50	61.98	38.17	7.45	20.54	51.80	74.00	54.00	PASS	
H		2485.50	55.08	38.17	7.45	20.54	44.90	74.00	54.00	PASS	
V		2483.50	63.22	38.2	7.45	20.54	53.01	74.00	54.00	PASS	
V		2485.50	51.92	38.2	7.45	20.54	41.71	74.00	54.00	PASS	
802.11n20		Low Channel 2412MHz									
		H	2390.00	60.50	38.06	7.42	20.15	50.01	74.00	54.00	PASS
	H	2400.00	54.60	38.06	7.42	20.15	44.11	74.00	54.00	PASS	
	V	2390.00	60.69	38.06	7.42	20.15	50.20	74.00	54.00	PASS	
	V	2400.00	51.75	38.06	7.42	20.15	41.26	74.00	54.00	PASS	
	High Channel 2462MHz										
	H	2483.50	60.09	38.17	7.45	20.54	49.91	74.00	54.00	PASS	
	H	2485.50	53.97	38.17	7.45	20.54	43.79	74.00	54.00	PASS	
	V	2483.50	60.75	38.2	7.45	20.54	50.54	74.00	54.00	PASS	
	V	2485.50	52.82	38.2	7.45	20.54	42.61	74.00	54.00	PASS	
	802.11n40	Low Channel 2422MHz									
		H	2390.00	64.31	38.06	7.42	20.15	53.82	74.00	54.00	PASS
H		2400.00	55.60	38.06	7.42	20.15	45.11	74.00	54.00	PASS	
V		2390.00	63.58	38.06	7.42	20.15	53.09	74.00	54.00	PASS	
V		2400.00	50.82	38.06	7.42	20.15	40.33	74.00	54.00	PASS	
High Channel 2452MHz											
H		2483.50	60.10	38.17	7.45	20.54	49.92	74.00	54.00	PASS	
H		2485.50	51.46	38.17	7.45	20.54	41.28	74.00	54.00	PASS	
V		2483.50	62.51	38.2	7.45	20.54	52.30	74.00	54.00	PASS	
V		2485.50	51.73	38.2	7.45	20.54	41.52	74.00	54.00	PASS	

Remark:

- Emission Level = Meter Reading + Antenna Factor + Cable Loss – Pre-amplifier, Margin= Emission Level - Limit
- If the PK measured levels comply with average limit, then the average level were deemed to comply with average limit.
* is stand for AV measured.

4. POWER SPECTRAL DENSITY TEST

4.1 APPLIED PROCEDURES / LIMIT

FCC Part15 (15.247) , Subpart C				
Section	Test Item	Limit	Frequency Range (MHz)	Result
15.247	Power Spectral Density	8 dBm (in any 3KHz)	2400-2483.5	PASS

4.1.1 TEST PROCEDURE

1. Set analyzer center frequency to DTS channel center frequency.
2. Set the span to 1.5 times the DTS bandwidth.
3. Set the RBW to: $3 \text{ kHz} \leq \text{RBW} \leq 100 \text{ kHz}$.
4. Set the VBW $\geq 3 \times \text{RBW}$.
5. Detector = peak.
6. Sweep time = auto couple.
7. Trace mode = max hold.
8. Allow trace to fully stabilize.
9. Use the peak marker function to determine the maximum amplitude level within the RBW.
10. If measured value exceeds limit, reduce RBW (no less than 3 kHz) and repeat.

4.1.2 DEVIATION FROM STANDARD

No deviation.

4.1.3 TEST SETUP



4.1.4 EUT OPERATION CONDITIONS

The EUT tested system was configured as the statements of 2.1 Unless otherwise a special operating condition is specified in the follows during the testing.

Note: Power Spectral Density(dBm)=Reading+Cable Loss

4.1.5 TEST RESULTS

Temperature :	26°C	Relative Humidity :	54%
Pressure :	101kPa	Test Voltage :	DC 14.52V
Test Mode :	TX b Mode		

Frequency	Power Spectral Density(dBm)	Limit (dBm)	Result
2412 MHz	-13.552	8	PASS
2437 MHz	-12.144	8	PASS
2462 MHz	-13.737	8	PASS

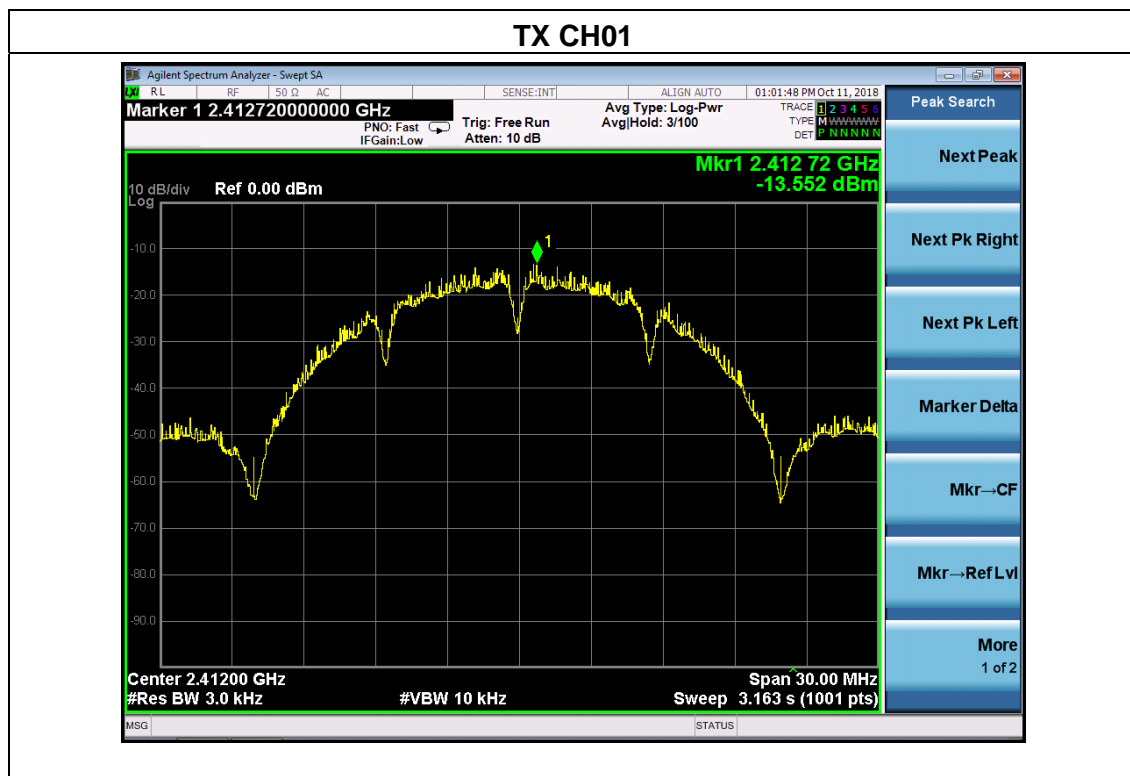

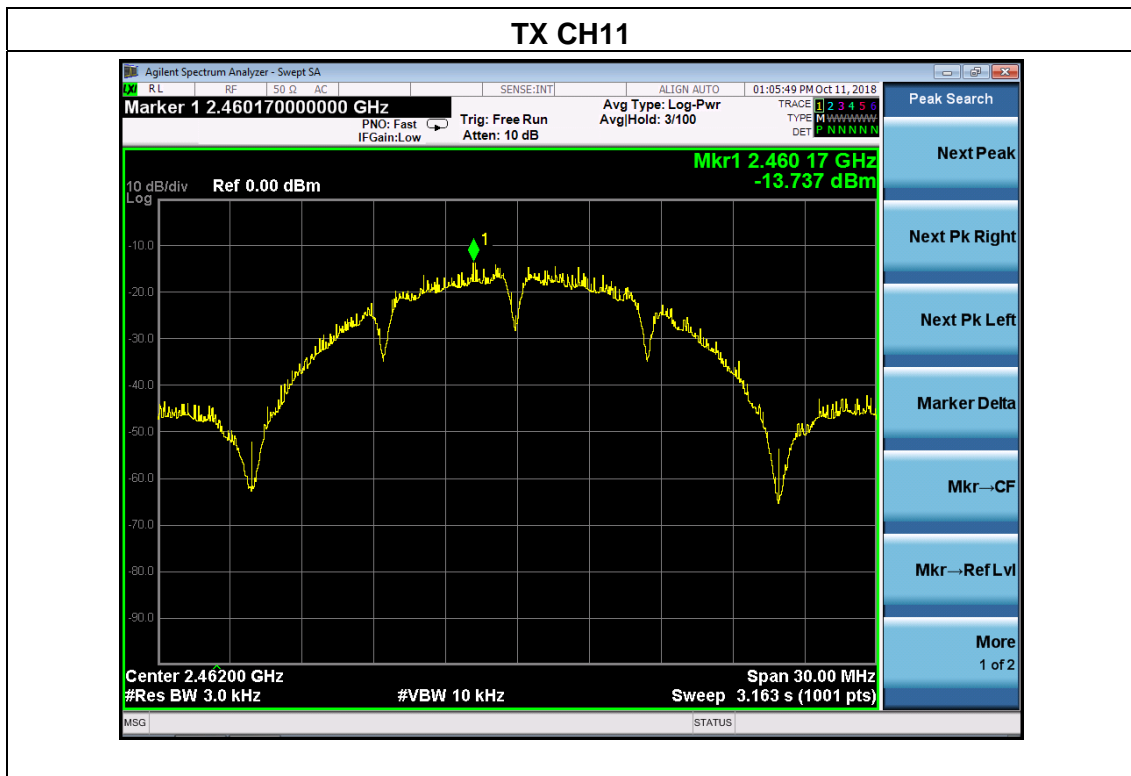
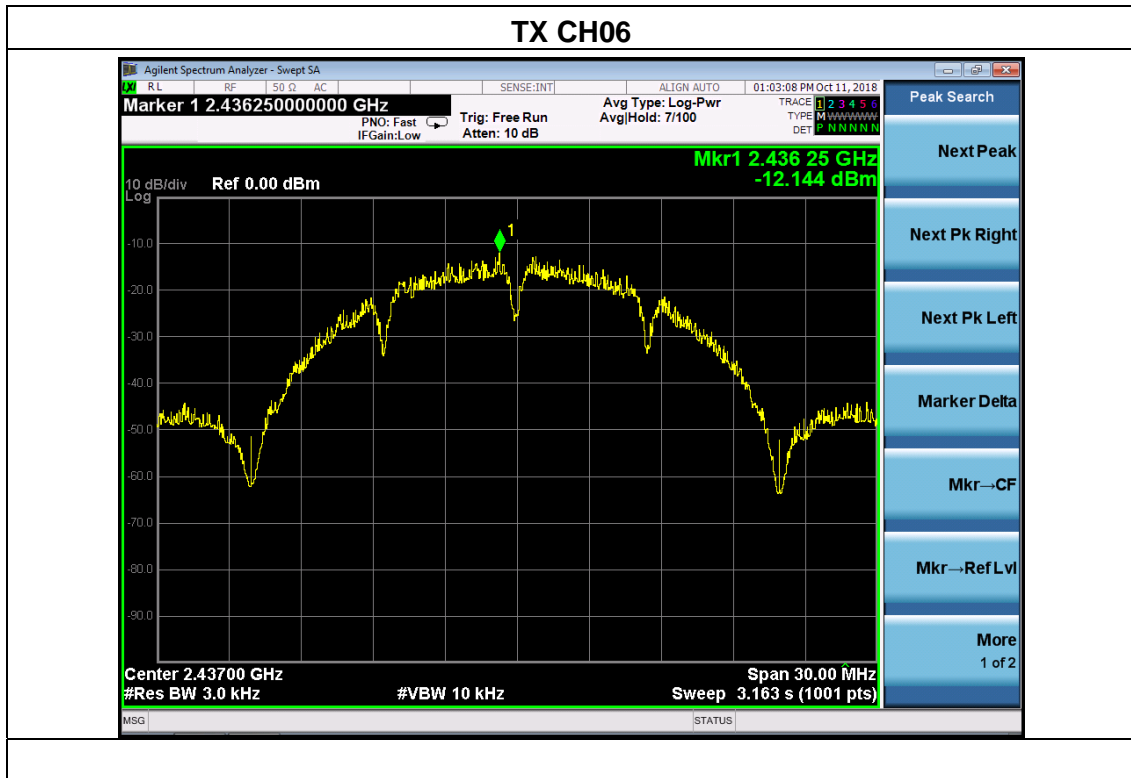



Temperature :	26°C	Relative Humidity :	54%
Pressure :	101kPa	Test Voltage :	DC 14.52V
Test Mode :	TX g Mode		

Frequency	Power Spectral Density(dBm)	Limit (dBm)	Result
2412 MHz	-16.314	8	PASS
2437 MHz	-15.708	8	PASS
2462 MHz	-16.404	8	PASS

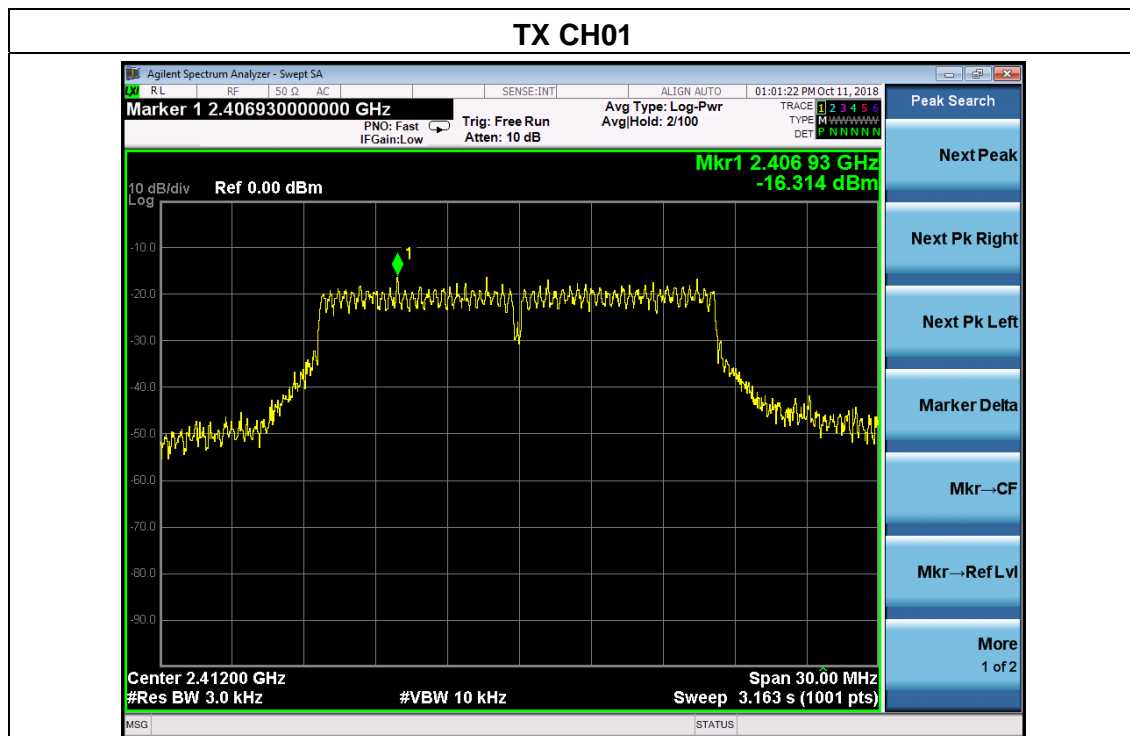

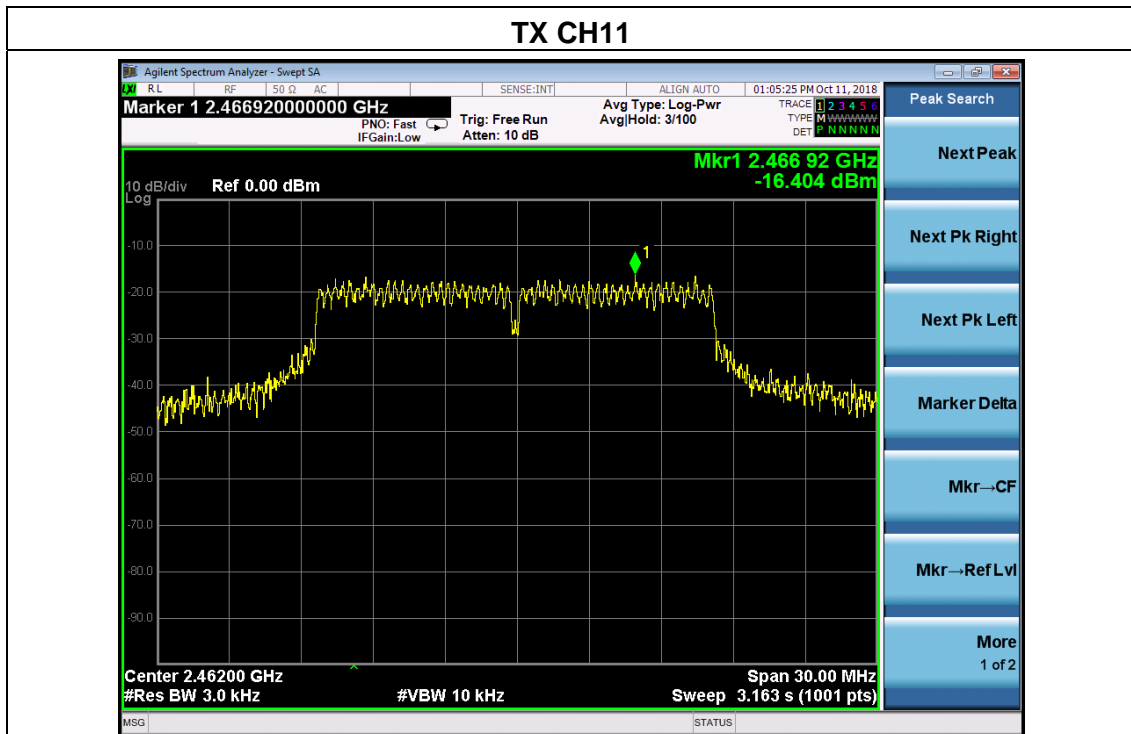
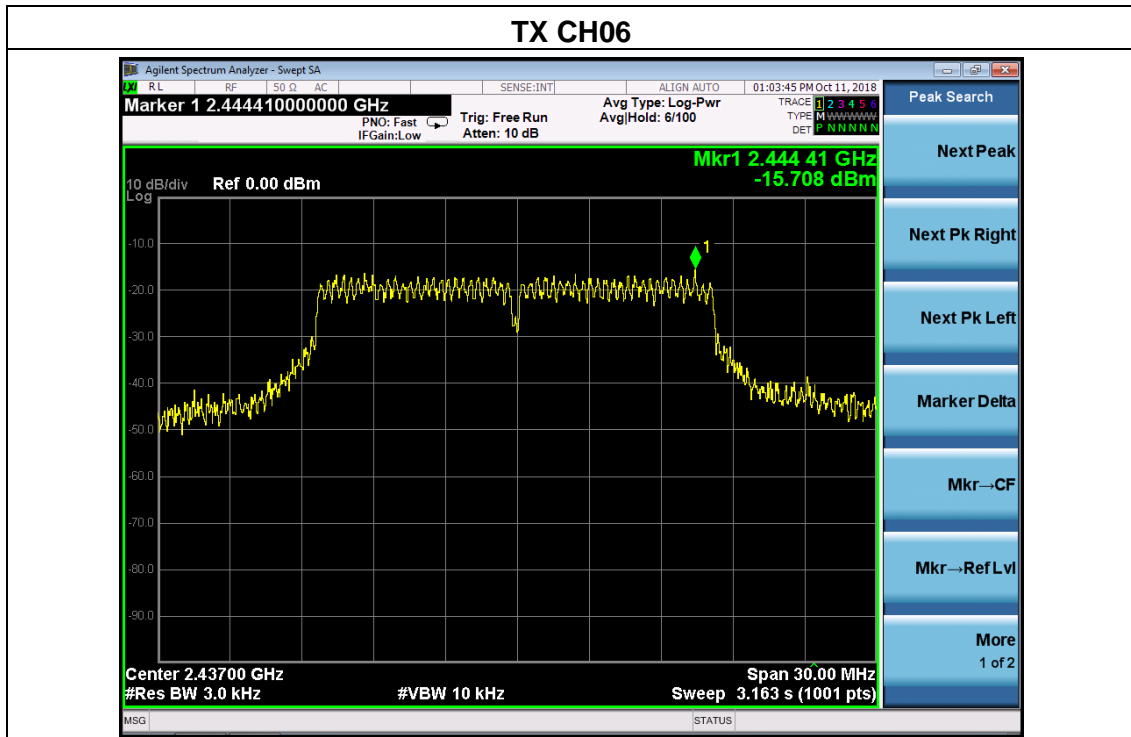



Temperature :	26°C	Relative Humidity :	54%
Pressure :	101kPa	Test Voltage :	DC 14.52V
Test Mode :	TX n Mode(20M)		

Frequency	Power Spectral Density(dBm)	Limit (dBm)	Result
2412 MHz	-16.830	8	PASS
2437 MHz	-16.946	8	PASS
2462 MHz	-17.182	8	PASS

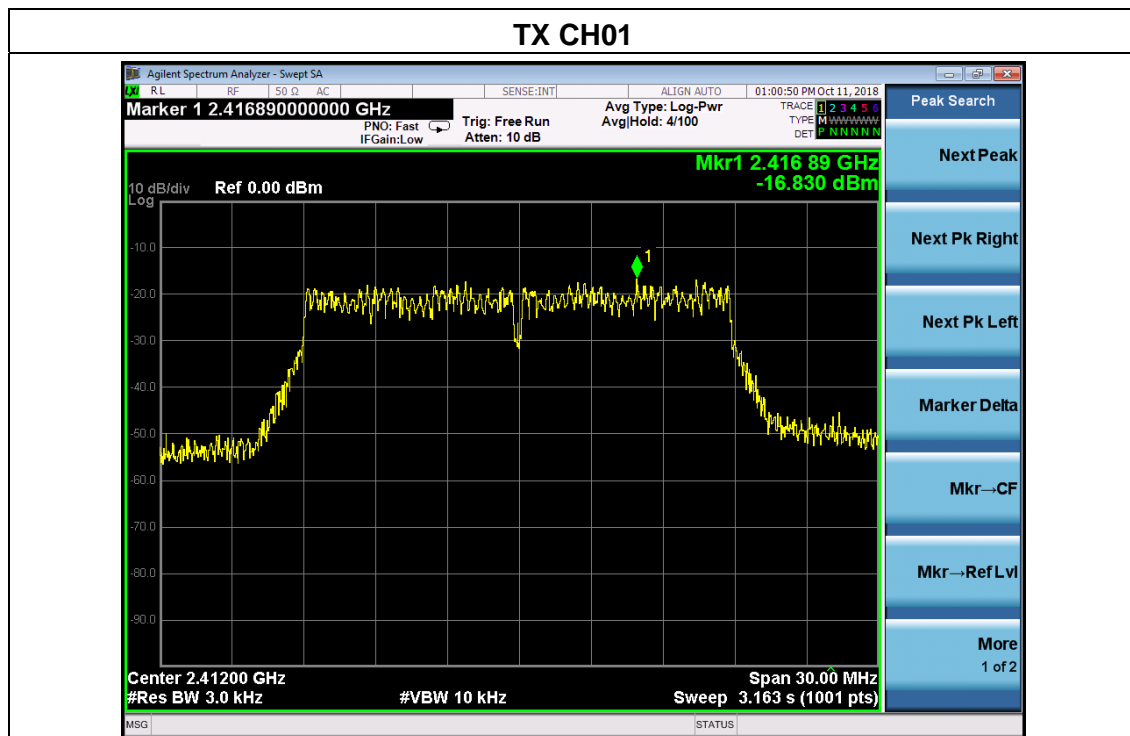

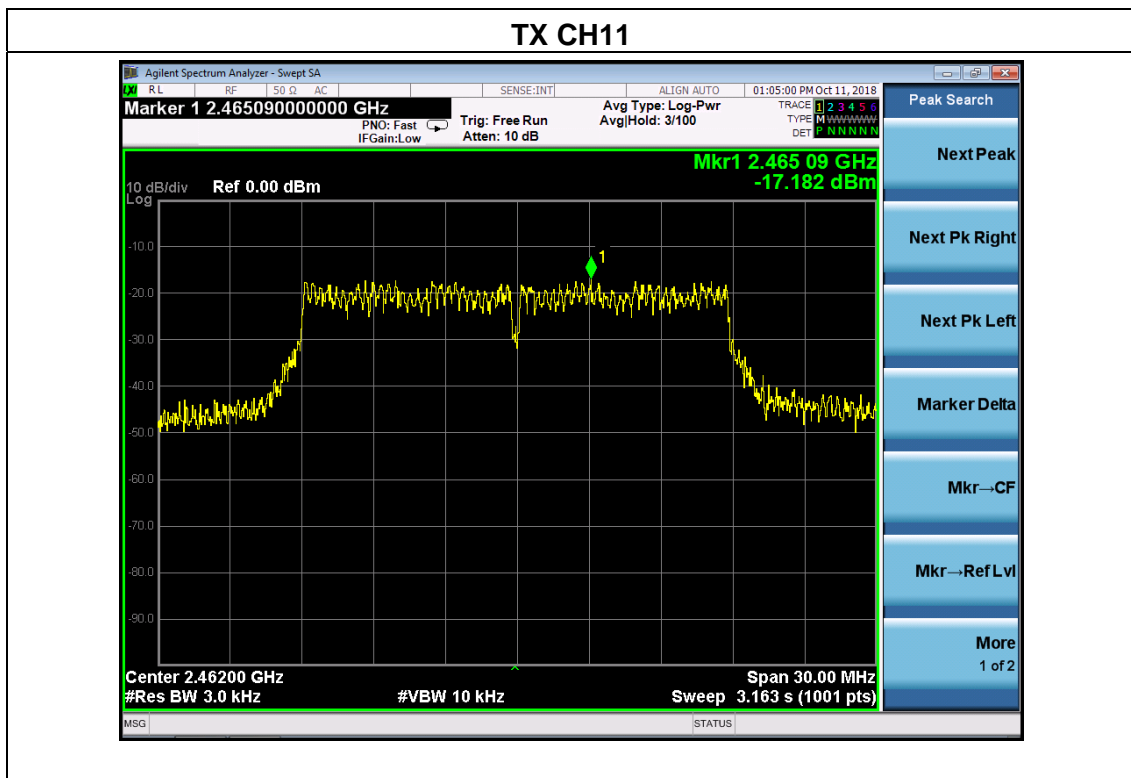
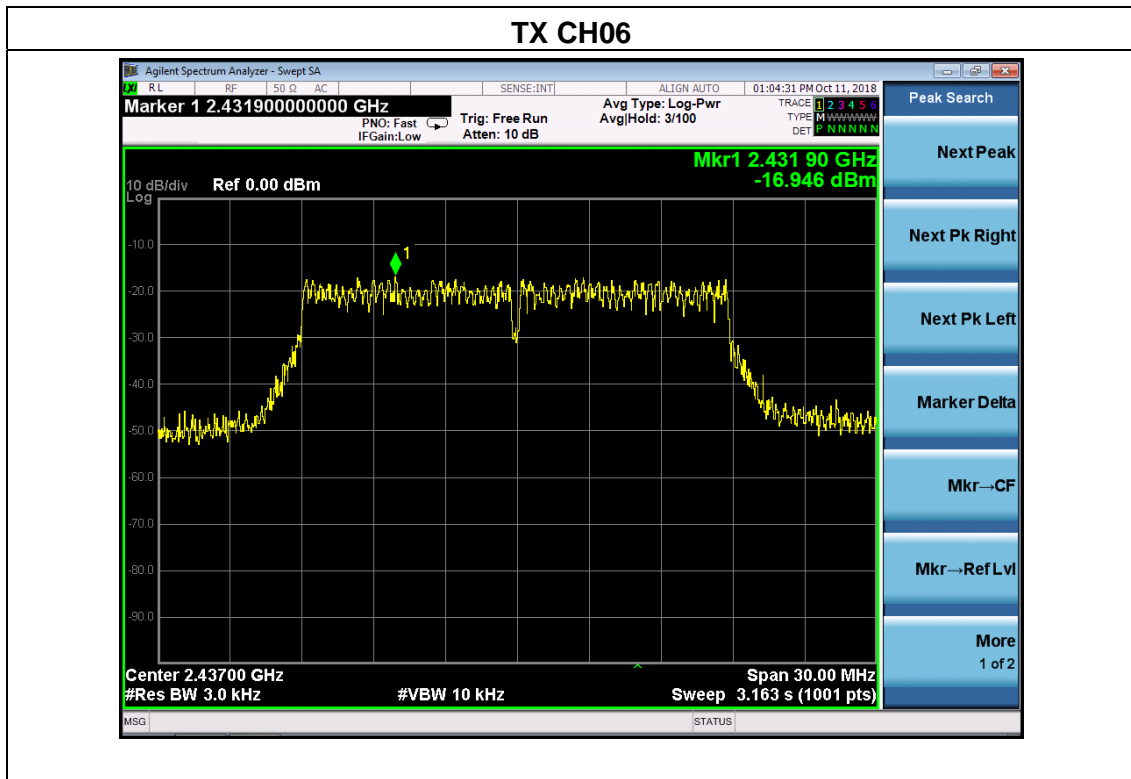



Temperature :	26°C	Relative Humidity :	54%
Pressure :	101kPa	Test Voltage :	DC 14.52V
Test Mode :	TX n Mode(40M)		

Frequency	Power Spectral Density(dBm)	Limit (dBm)	Result
2422 MHz	-17.997	8	PASS
2437 MHz	-18.344	8	PASS
2452 MHz	-17.421	8	PASS

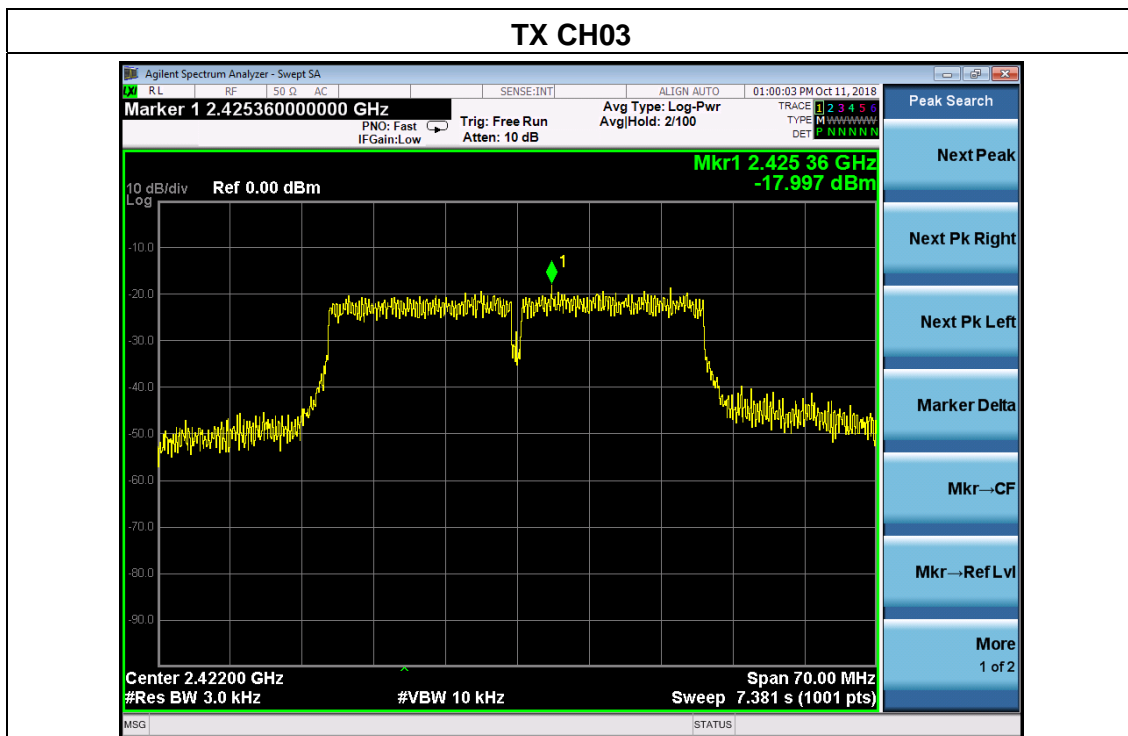

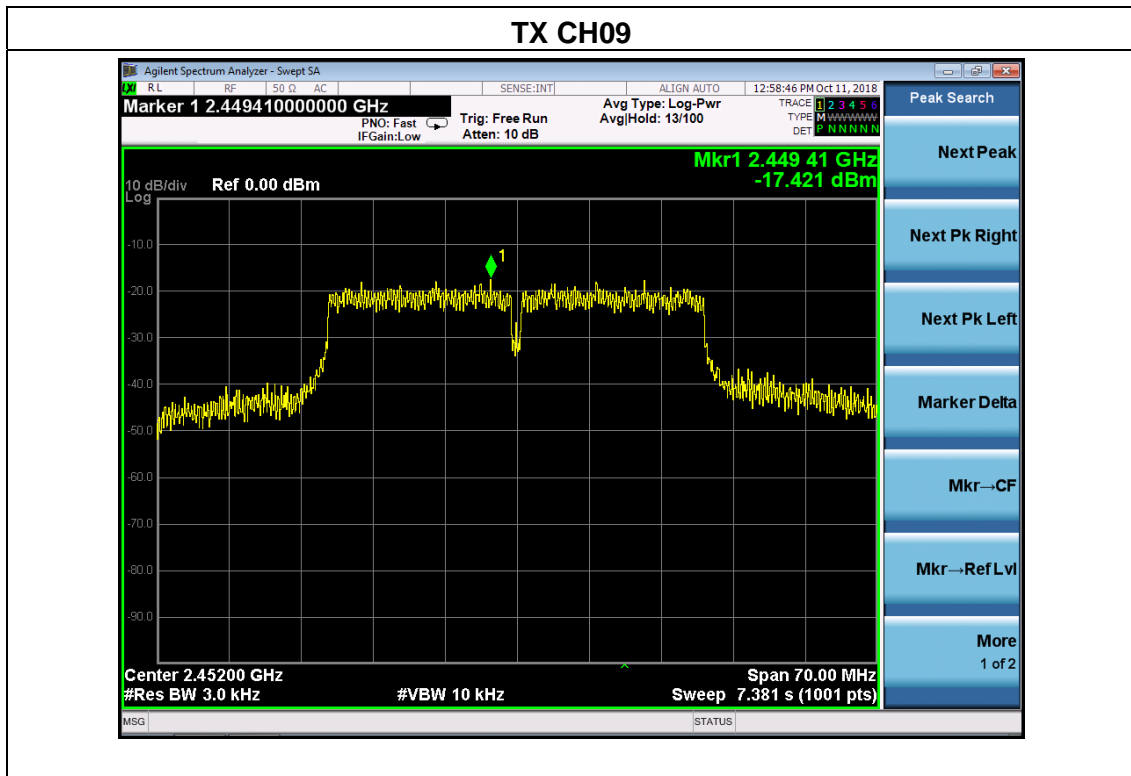
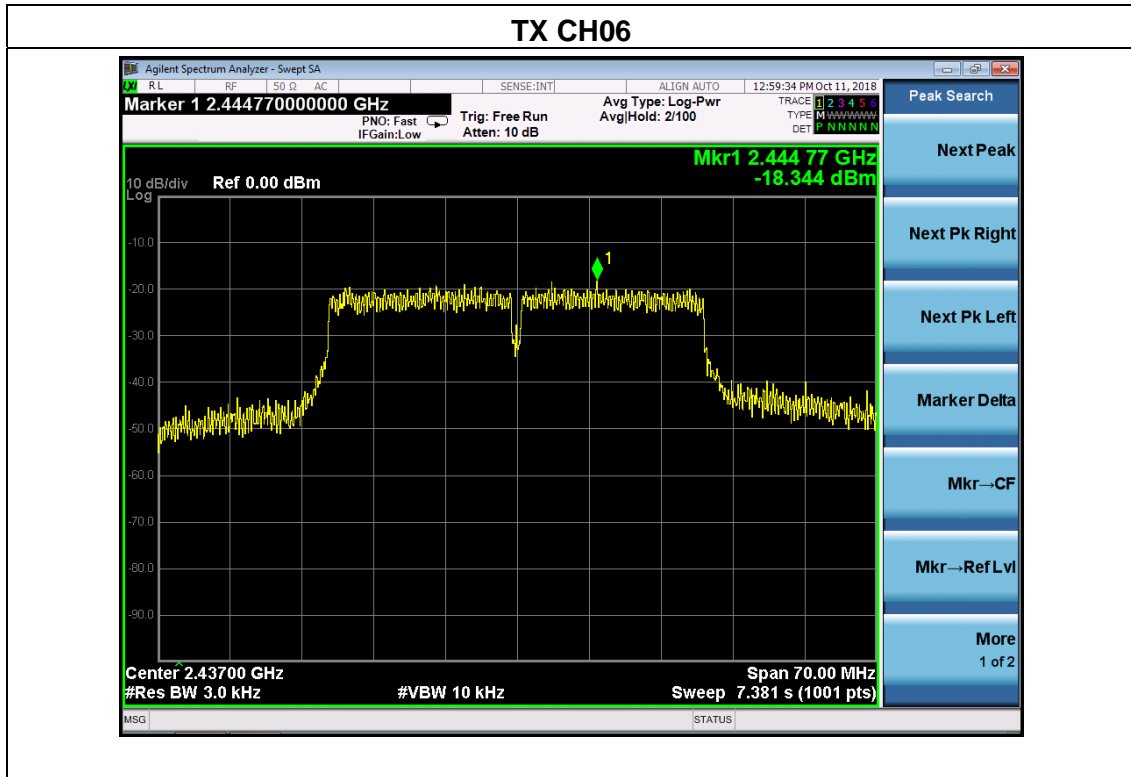

5. BANDWIDTH TEST

5.1 APPLIED PROCEDURES / LIMIT

FCC Part15 (15.247) , Subpart C				
Section	Test Item	Limit	Frequency Range (MHz)	Result
15.247(a)(2)	Bandwidth	$\geq 500\text{KHz}$ (6dB bandwidth)	2400-2483.5	PASS

5.1.1 TEST PROCEDURE

1. Set RBW = 100 kHz.
2. Set the video bandwidth (VBW) $\geq 3 \times$ RBW.
3. Detector = Peak.
4. Trace mode = max hold.
5. Sweep = auto couple.
6. Allow the trace to stabilize.
7. Measure the maximum width of the emission that is constrained by the frequencies associated with the two outermost amplitude points (upper and lower frequencies) that are attenuated by 6 dB relative to the maximum level measured in the fundamental emission.

5.1.2 DEVIATION FROM STANDARD

No deviation.

5.1.3 TEST SETUP



5.1.4 EUT OPERATION CONDITIONS

The EUT tested system was configured as the statements of 2.4 Unless otherwise a special operating condition is specified in the follows during the testing.

5.1.5 TEST RESULTS

Temperature :	26°C	Relative Humidity :	54%
Pressure :	101kPa	Test Voltage :	DC 14.52V
Test Mode :	TX b Mode		

Frequency (MHz)	6dB bandwidth (MHz)	Limit (kHz)	Result
2412	10.06	500	Pass
2437	10.06	500	Pass
2462	10.07	500	Pass

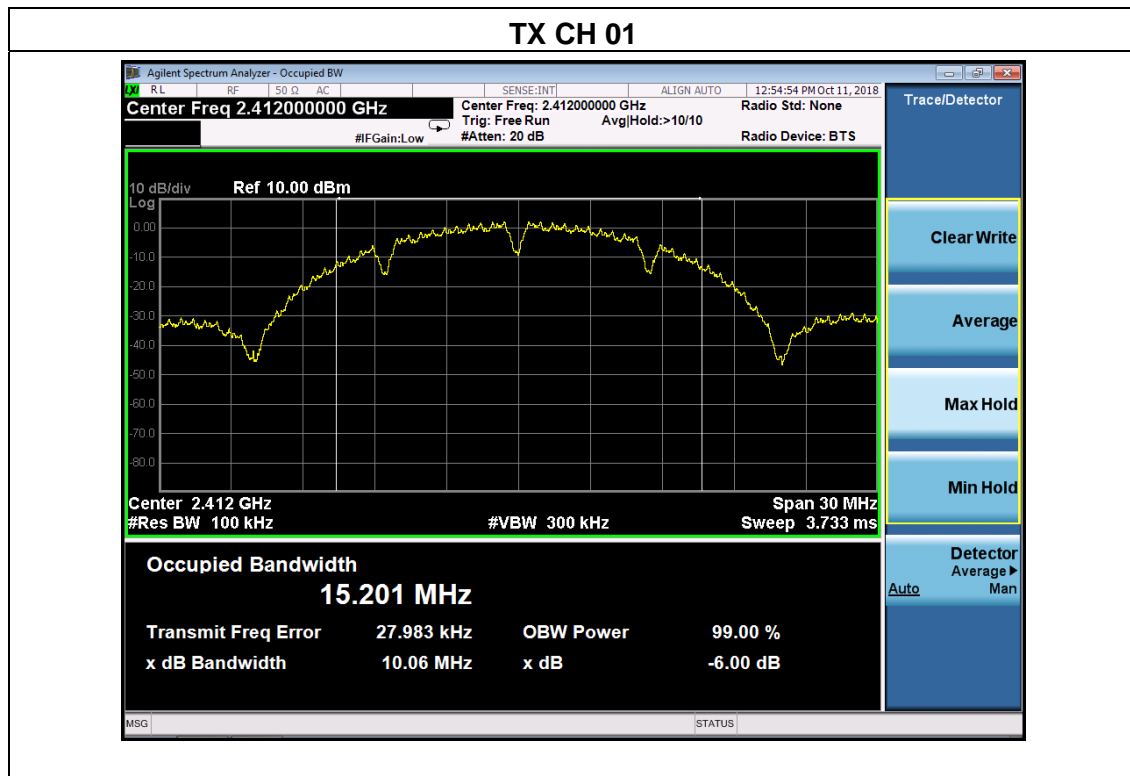



TX CH 06

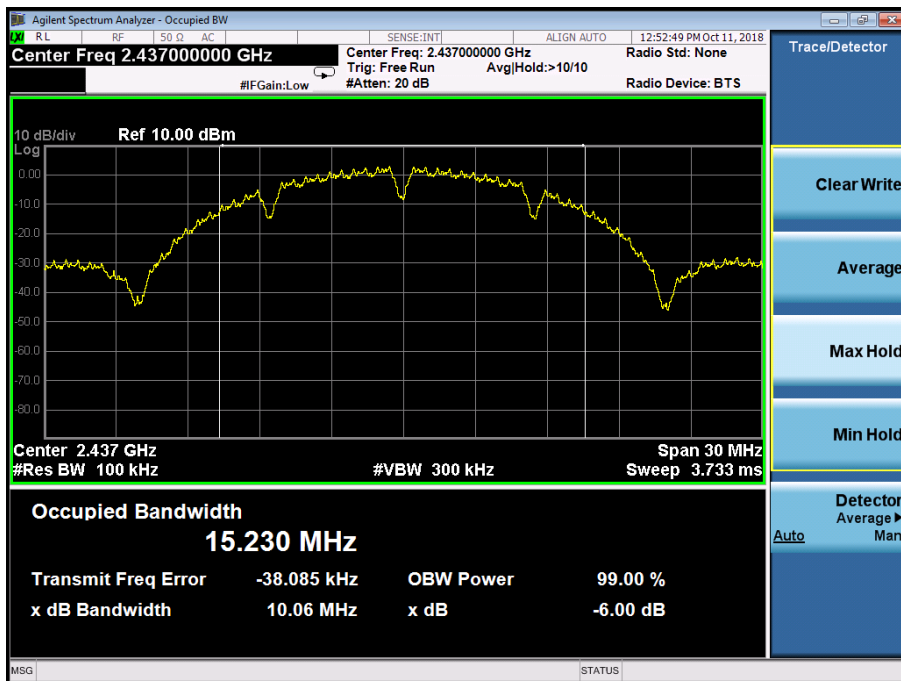

TX CH 11

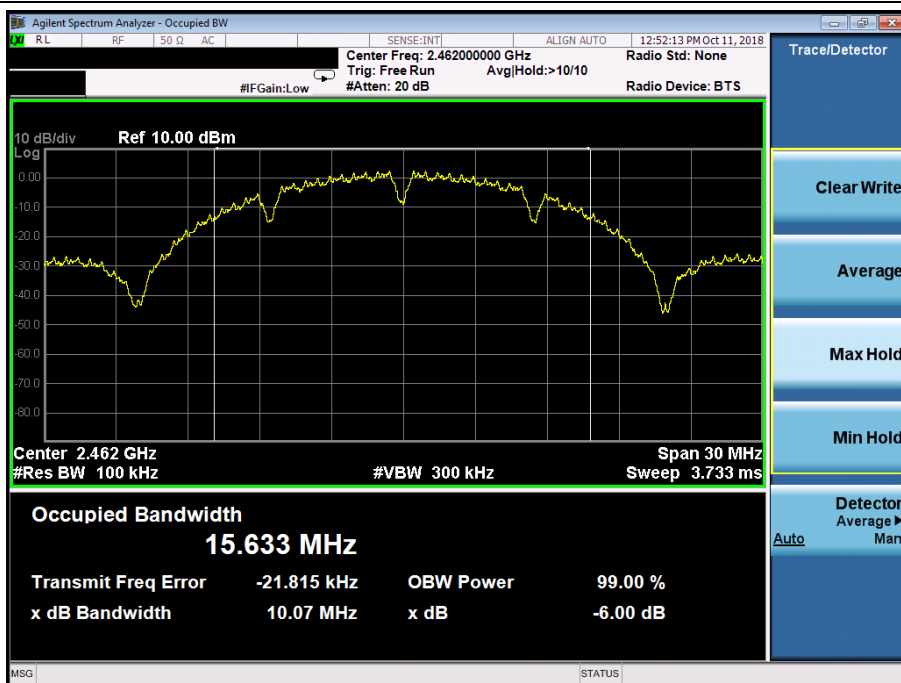



Temperature :	26°C	Relative Humidity :	54%
Pressure :	101kPa	Test Voltage :	DC 14.52V
Test Mode :	TX g Mode		

Frequency (MHz)	6dB bandwidth (MHz)	Limit (kHz)	Result
2412	16.36	500	Pass
2437	16.37	500	Pass
2462	16.38	500	Pass

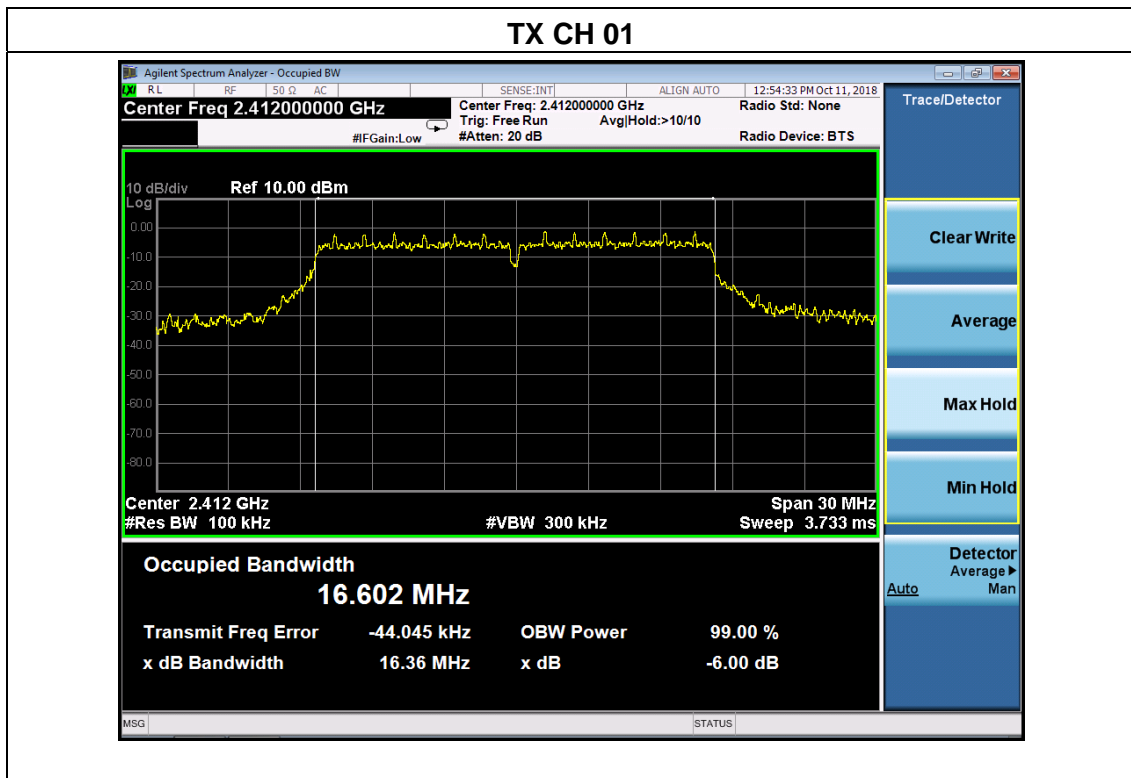



TX CH 06

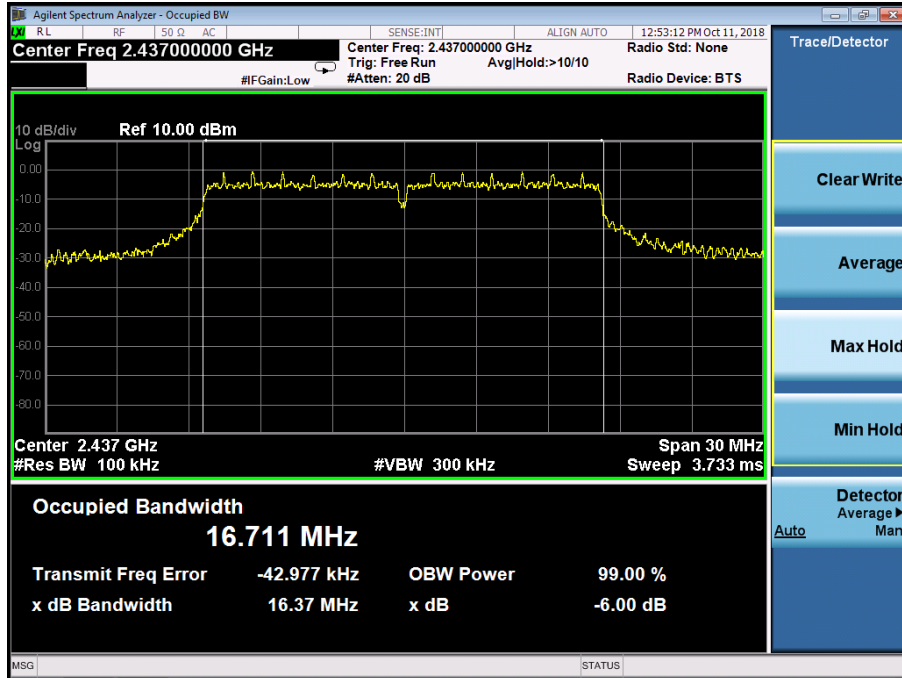

TX CH 11

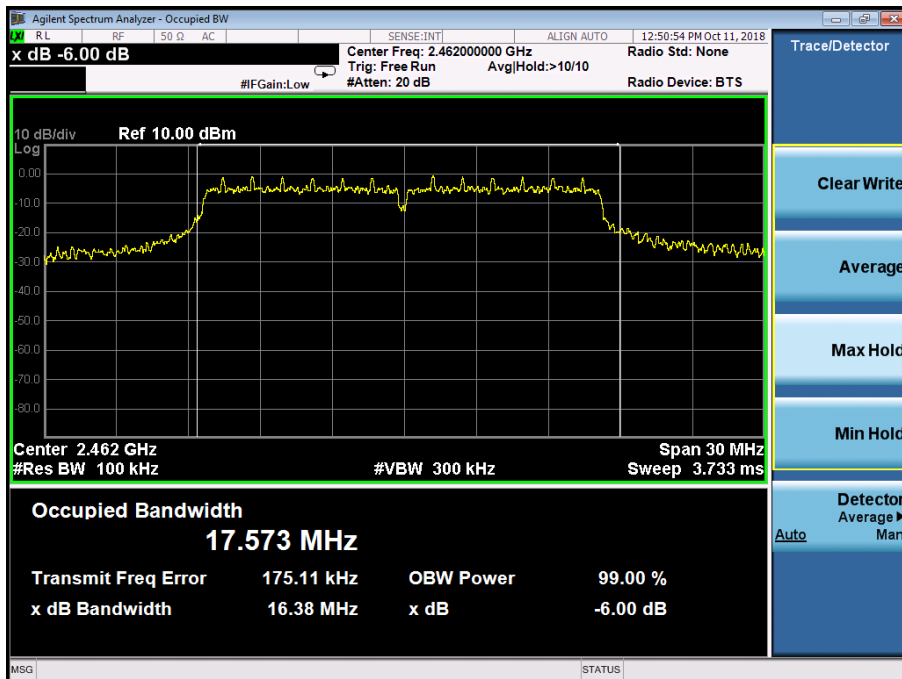

Temperature :	26°C	Relative Humidity :	54%
Pressure :	101kPa	Test Voltage :	DC 14.52V
Test Mode :	TX n Mode(20M)		

Frequency (MHz)	6dB bandwidth (MHz)	Limit (kHz)	Result
2412	17.67	500	Pass
2437	17.67	500	Pass
2462	17.68	500	Pass

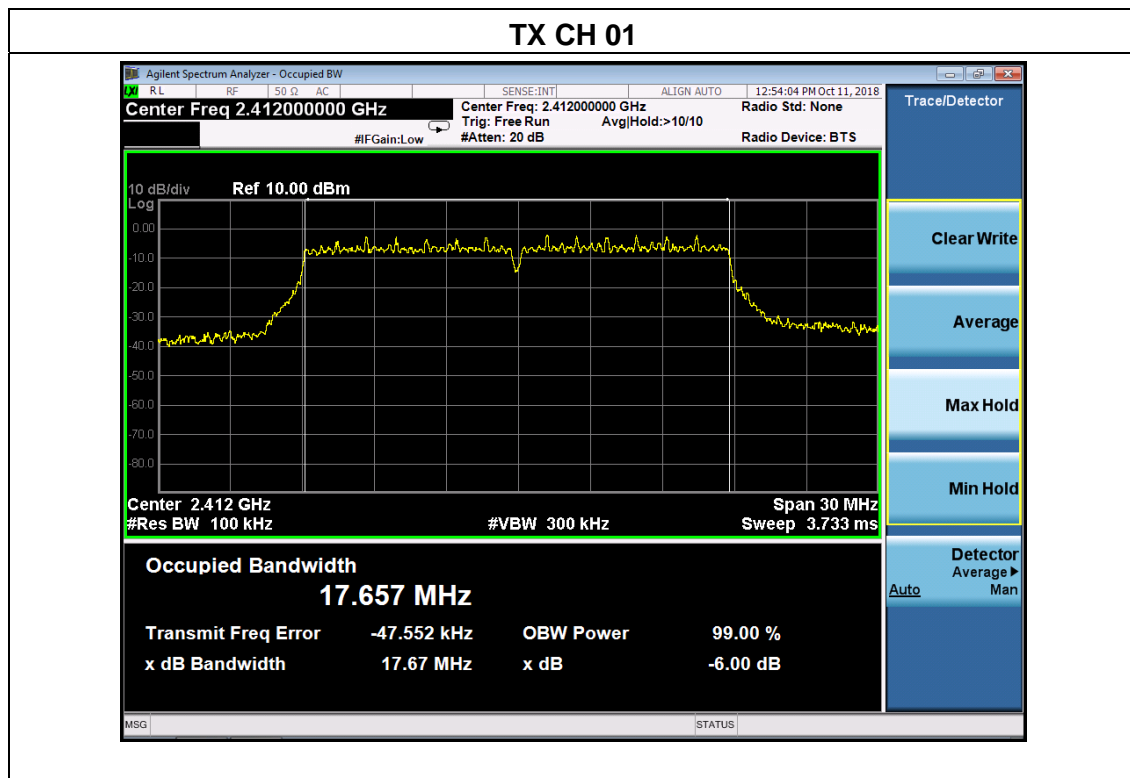



TX CH 06

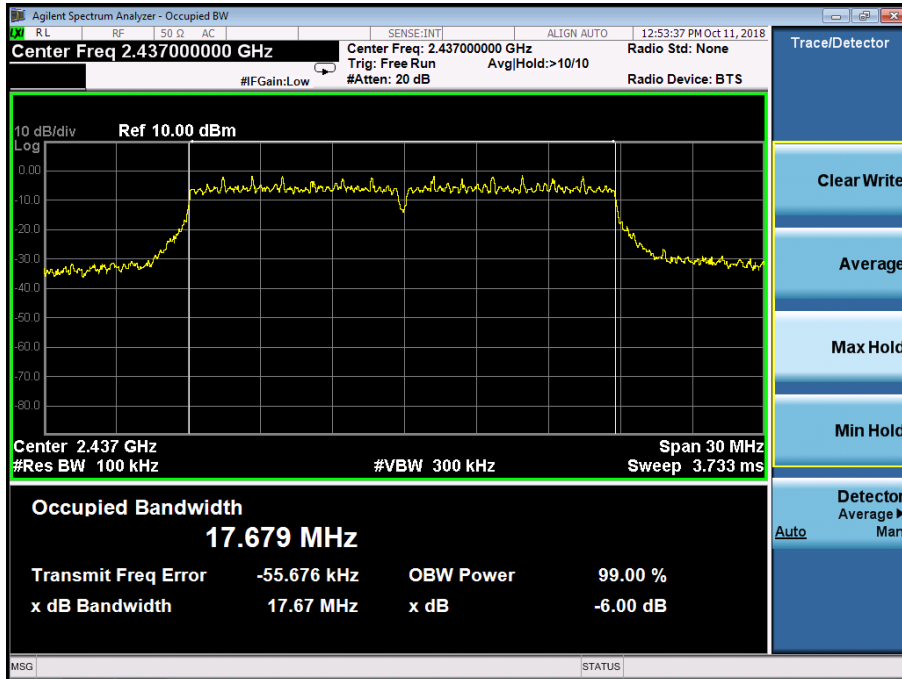

TX CH 11

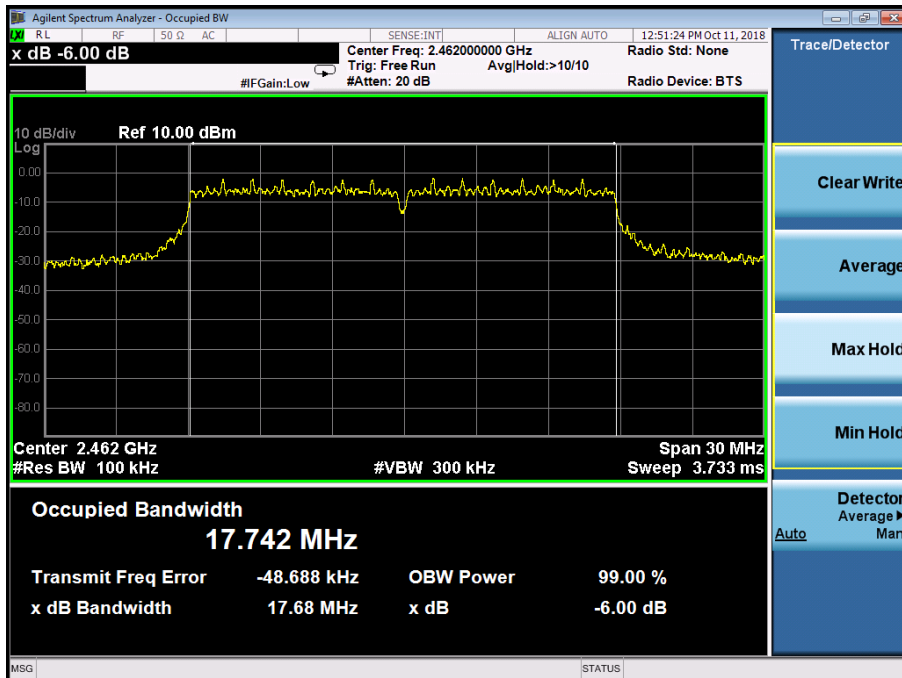



Temperature :	26°C	Relative Humidity :	54%
Pressure :	101kPa	Test Voltage :	DC 14.52V
Test Mode :	TX n Mode(40M)		

Frequency (MHz)	6dB bandwidth (MHz)	Limit (kHz)	Result
2422	36.35	500	Pass
2437	36.34	500	Pass
2452	36.35	500	Pass

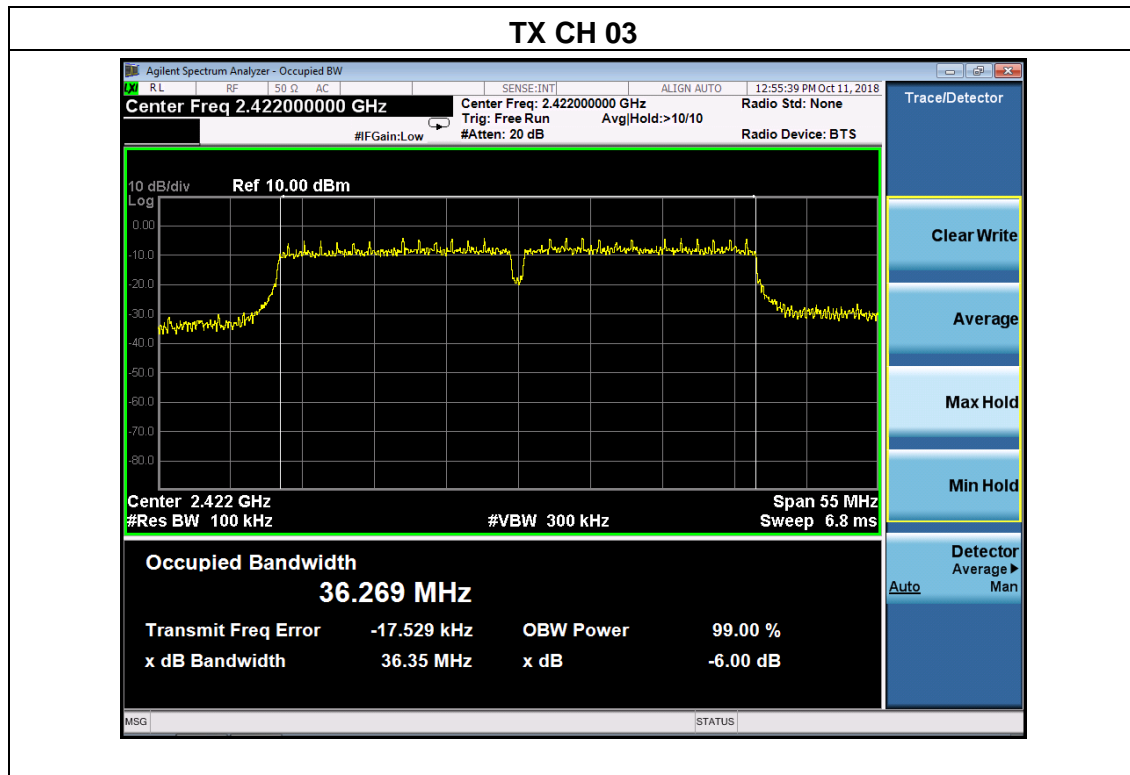



TX CH 06

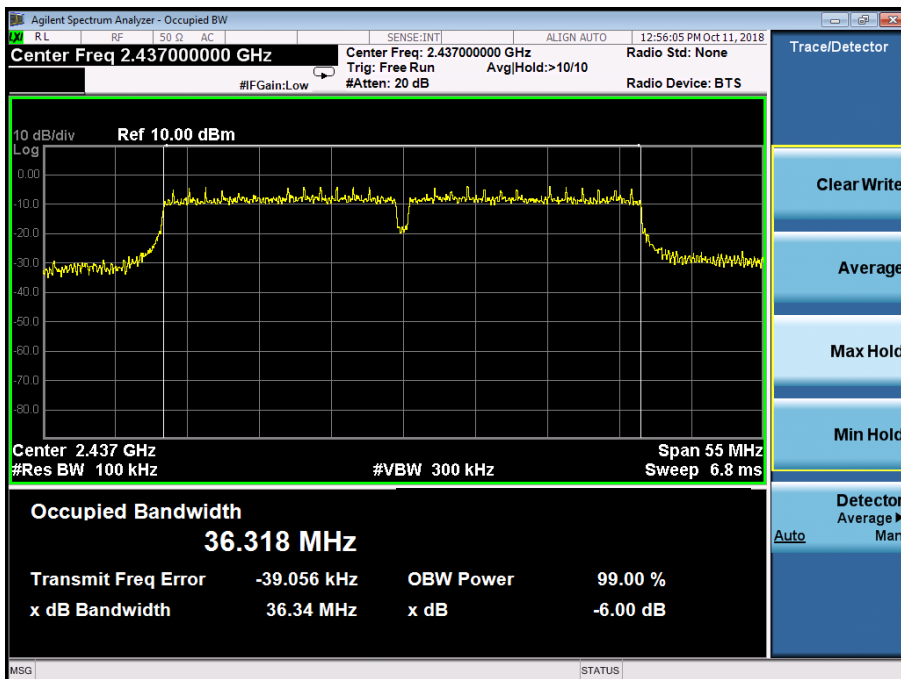

TX CH 09

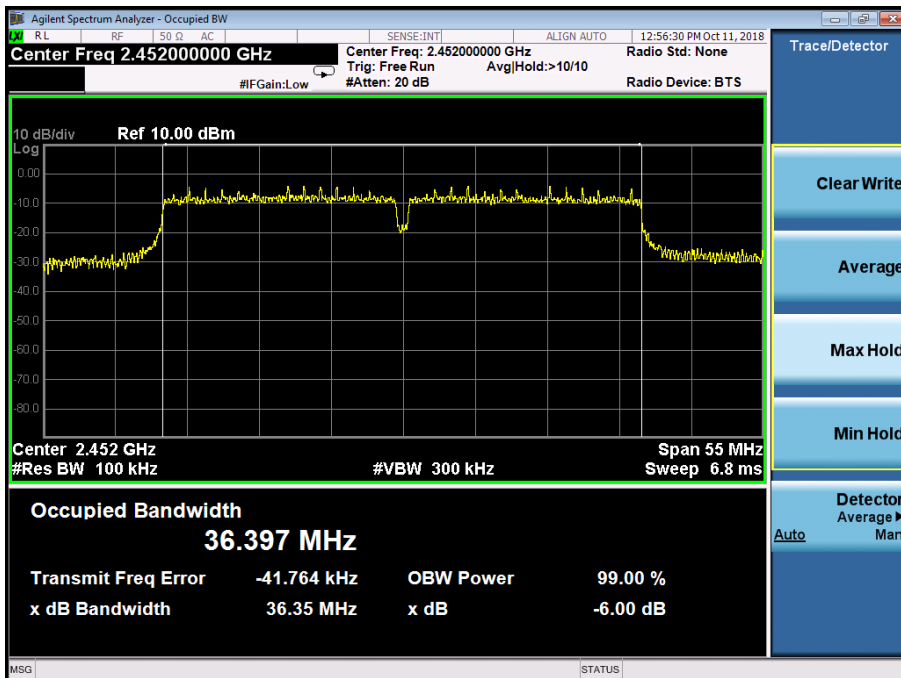

6. PEAK OUTPUT POWER TEST

6.1 APPLIED PROCEDURES/LIMIT

FCC Part15 (15.247) , Subpart C				
Section	Test Item	Limit	Frequency Range (MHz)	Result
15.247(b)(3)	Peak Output Power	1 watt or 30dBm	2400-2483.5	PASS

6.1.1 TEST PROCEDURE

- a. The EUT was directly connected to the Power meter

6.1.2 DEVIATION FROM STANDARD

No deviation.

6.1.3 TEST SETUP



6.1.4 EUT OPERATION CONDITIONS

The EUT tested system was configured as the statements of 2.4 Unless otherwise a special operating condition is specified in the follows during the testing.

6.1.5 TEST RESULTS

Temperature :	26℃	Relative Humidity :	54%
Pressure :	101kPa	Test Voltage :	DC 14.52V

	Frequency	Maximum Conducted Output Power(PK)	LIMIT
	(MHz)	(dBm)	dBm
802.11b	2412	11.215	30
	2437	11.830	30
	2462	11.429	30
802.11g	2412	10.090	30
	2437	10.056	30
	2462	10.867	30
802.11n20	2412	9.429	30
	2437	9.079	30
	2462	8.728	30
802.11n40	2422	7.375	30
	2437	7.878	30
	2452	7.529	30

7. 100 KHZ BANDWIDTH OF FREQUENCY BAND EDGE

7.1 APPLICABLE STANDARD

in any 100 kHz bandwidth outside the frequency bands in which the spread spectrum intentional radiator is operating, the radio frequency power that is produced by the intentional radiator shall be at least 20dB below that in the 100kHz bandwidth within the band that contains the highest level of the desired power, In addition, radiated emissions which fall in the restricted bands, as defined in§15.205(a), must also comply with the radiated emission limits specified in15.209(a).

7.2 TEST PROCEDURE

Using the following spectrum analyzer setting:

- a) Set the RBW = 100KHz.
- b) Set the VBW = 300KHz.
- c) Sweep time = auto couple.
- d) Detector function = peak.
- e) Trace mode = max hold.
- f) Allow trace to fully stabilize.

7.3 DEVIATION FROM STANDARD

No deviation.

7.4 TEST SETUP



7.5 EUT OPERATION CONDITIONS

The EUT tested system was configured as the statements of 2.4 Unless otherwise a special operating condition is specified in the follows during the testing.

7.1 TEST RESULTS



802.11b: Band Edge, Left Side



802.11b: Band Edge, Right Side





802.11g: Band Edge, Left Side



802.11g: Band Edge, Right Side

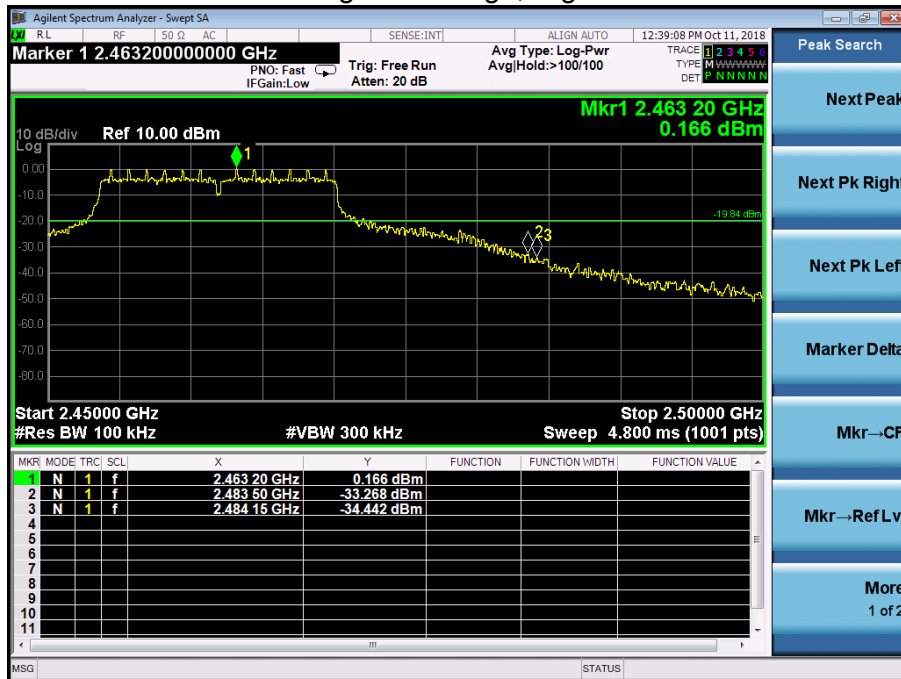



802.11n-HT20: Band Edge, Left Side

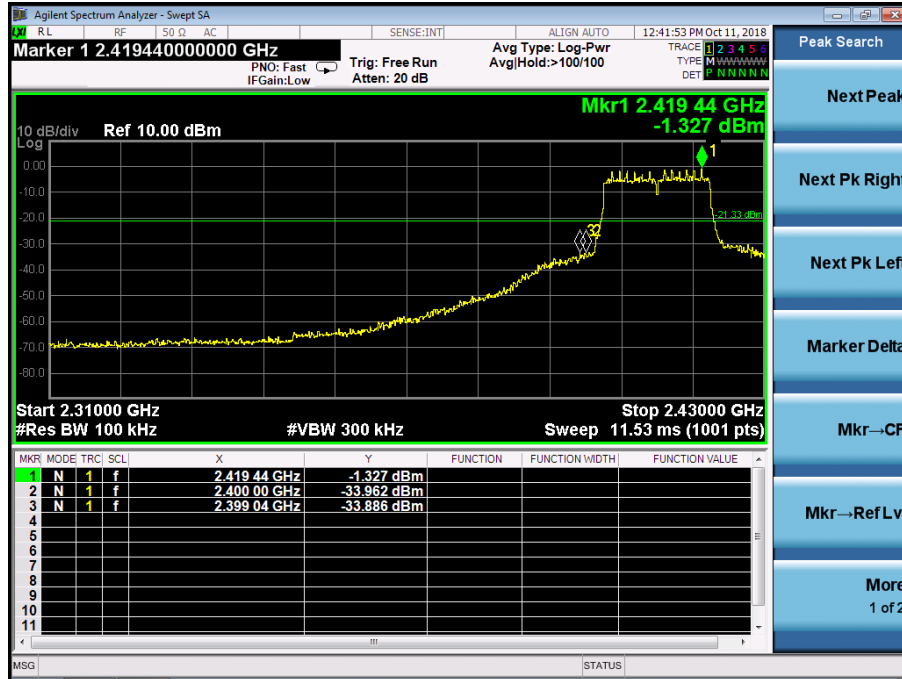

802.11n-HT20: Band Edge, Right Side





802.11n-HT40: Band Edge, Left Side

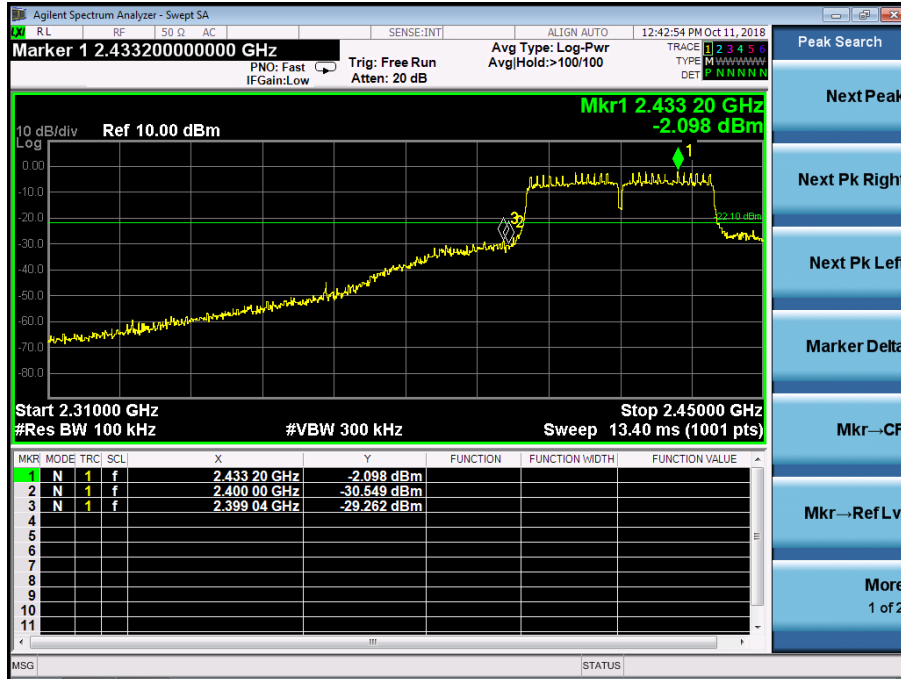

802.11n-HT40: Band Edge, Right Side

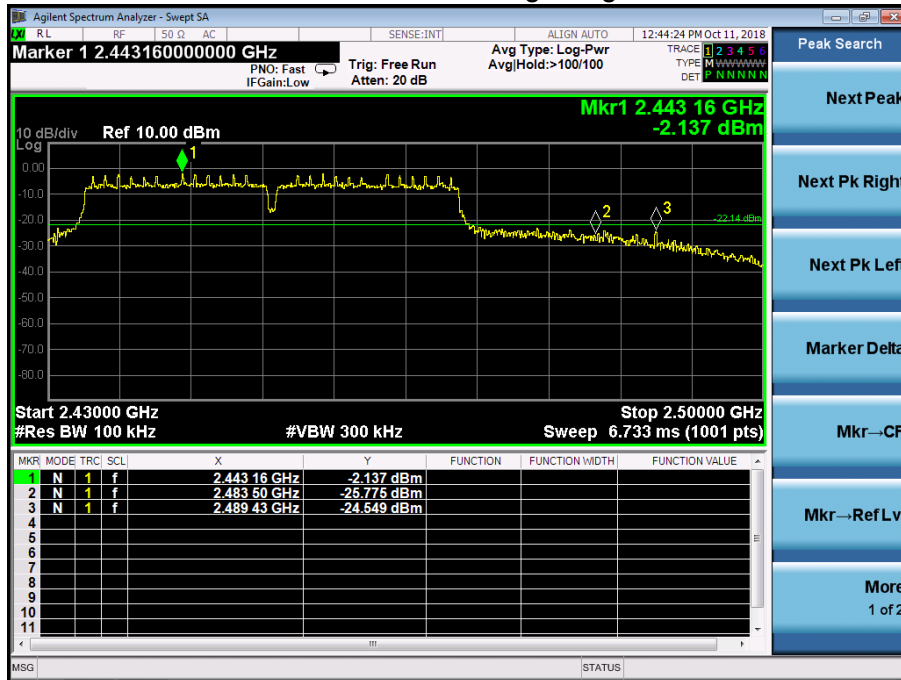

CONDUCTED EMISSION MEASUREMENT

802.11b

Low Channel 2412MHz

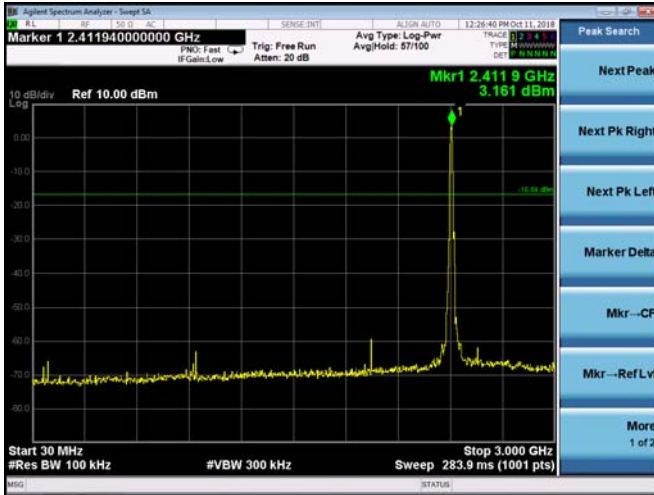

Middle Channel 2437MHz

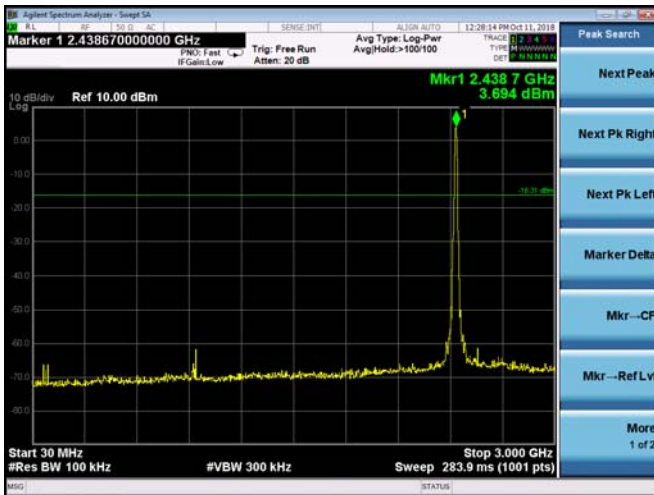

High Channel 2462MHz

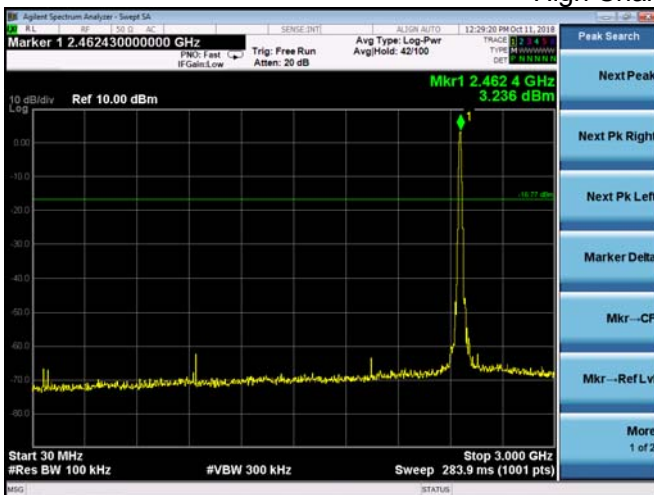



802.11g

Low Channel 2412MHz

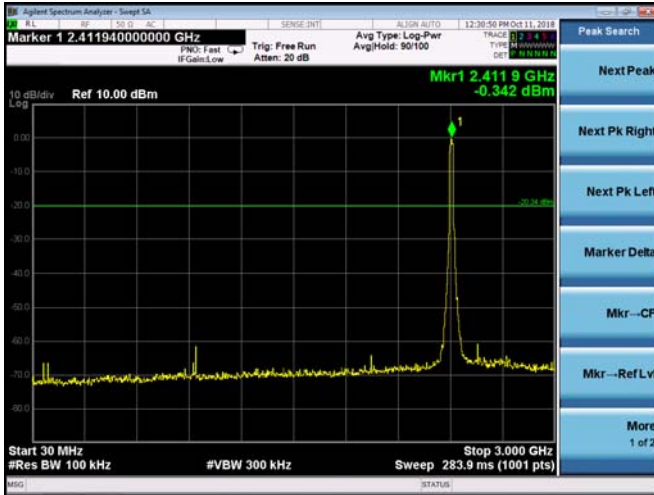

Middle Channel 2437MHz

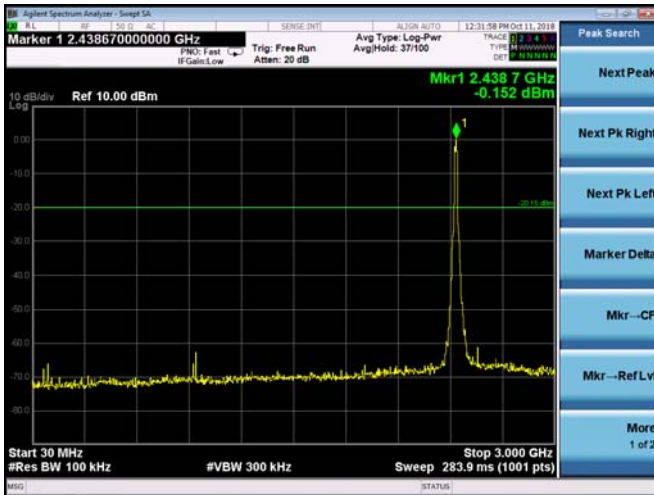

High Channel 2462MHz

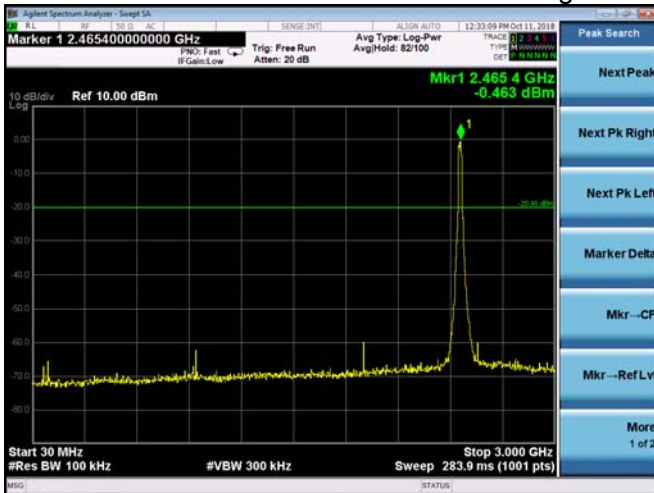



802.11n20

Low Channel 2412MHz

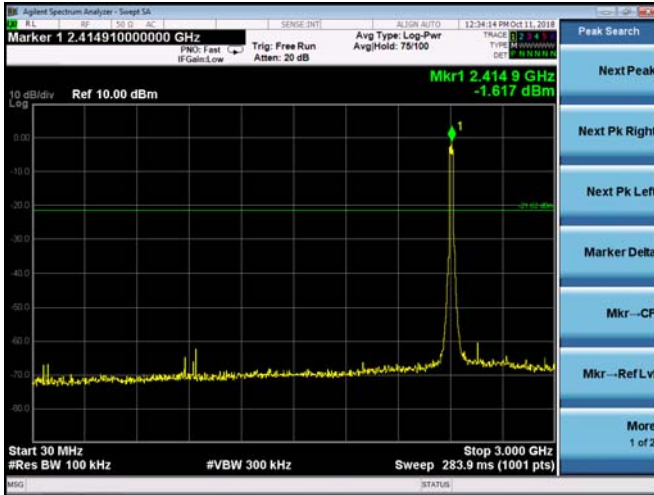

Middle Channel 2437MHz

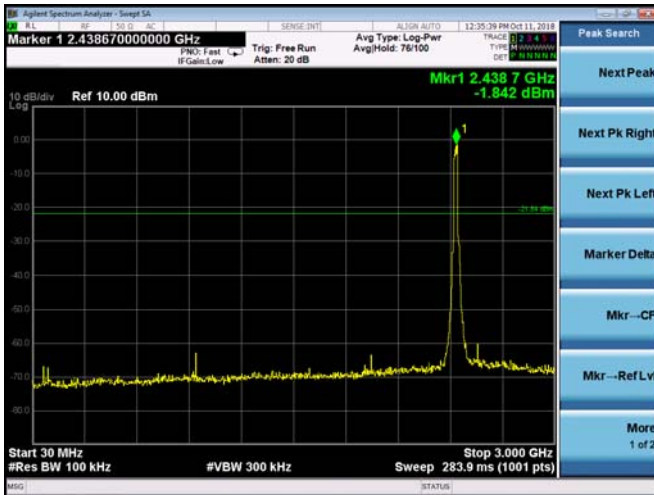

High Channel 2462MHz

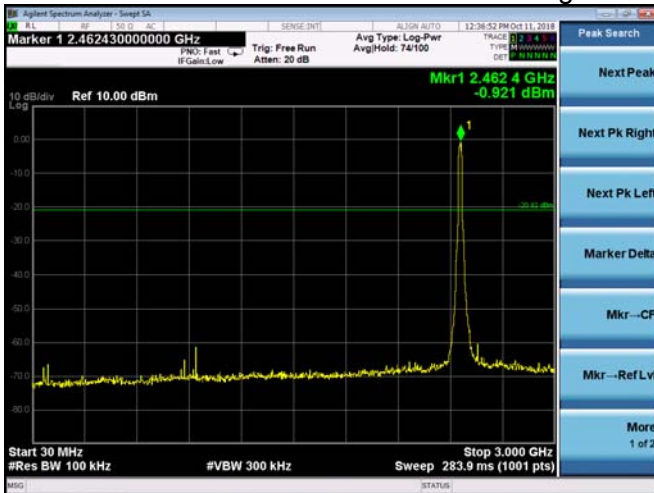



802.11n40

Low Channel 2422MHz

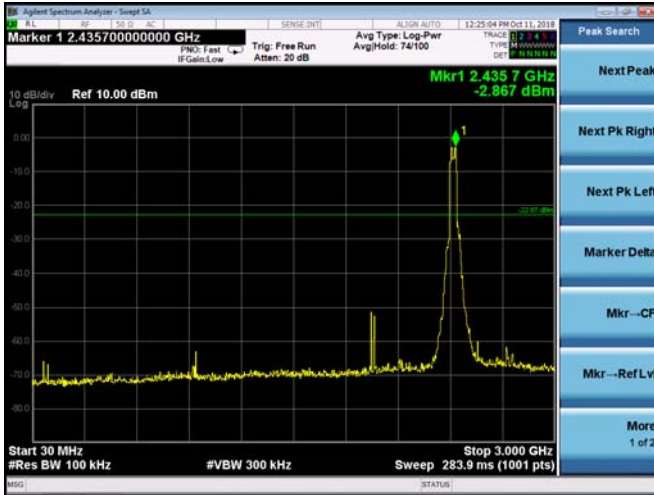

Middle Channel 2437MHz

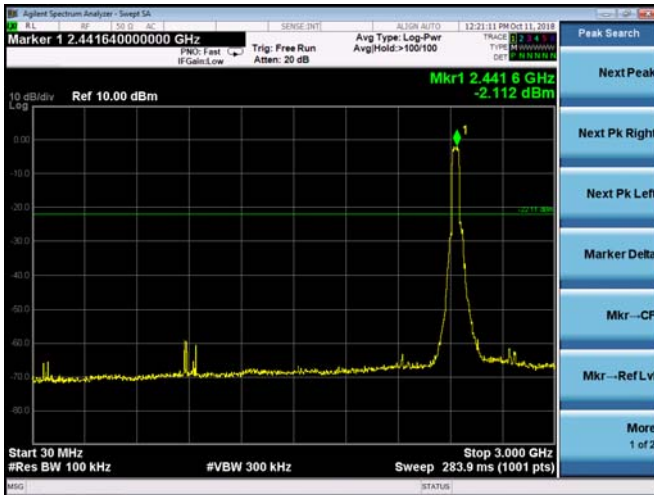

High Channel 2452MHz

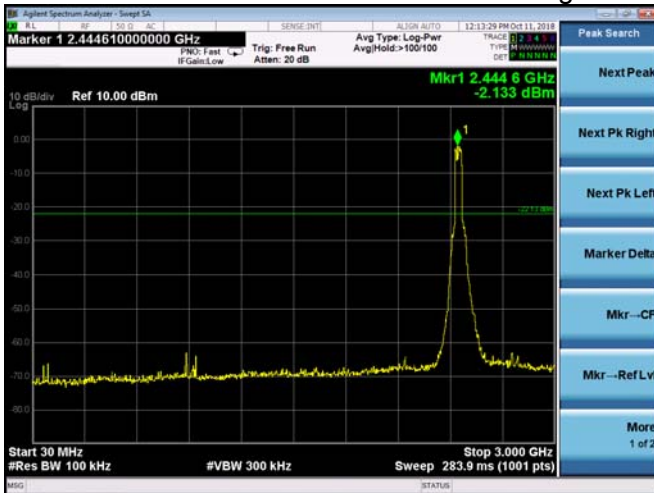

8. DUTY CYCLE OF TEST SIGNAL

8.1 STANDARD REQUIREMENT

Pre-analysis Check: While conducting average power measurement, duty cycle of each mode shall be checked to ensure its duty cycle in order to compensate for the loss due to insufficient ratio of duty cycle.

All duty cycle is pre-scanned, and result as obtained below shows only the most representative ones where duty cycle is conducted as the given transmission with given virtual operation that expresses the percentage.

8.2 FORMULA:

$$\text{Duty Cycle} = \text{Ton} / (\text{Ton} + \text{Toff})$$

Measurement Procedure:

1. Set span = Zero
2. RBW = 8MHz
3. VBW = 8MHz,
4. Detector = Peak

Duty Cycle:

	Duty Cycle	Duty Fator (dB)
802.11b	1	0
802.11g	1	0
802.11n(HT20)	1	0
802.11n(HT40)	1	0

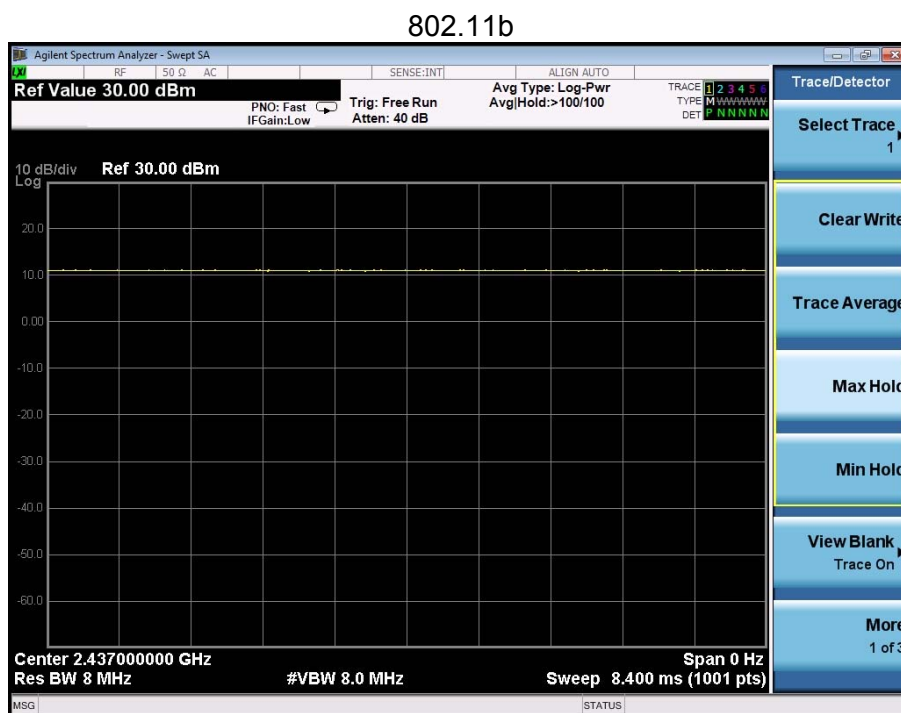



802.11g

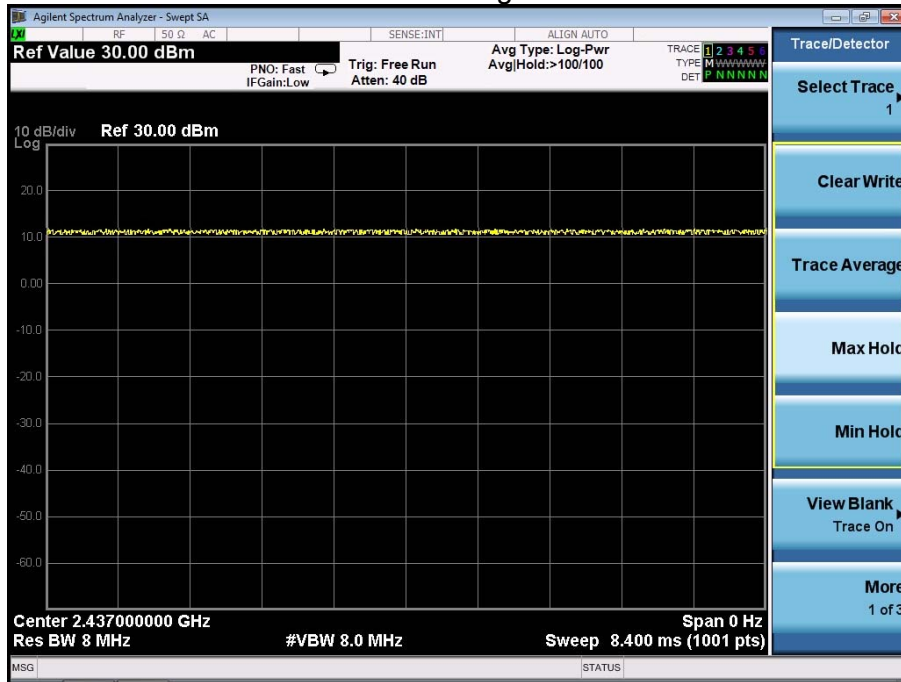

802.11n(HT20)

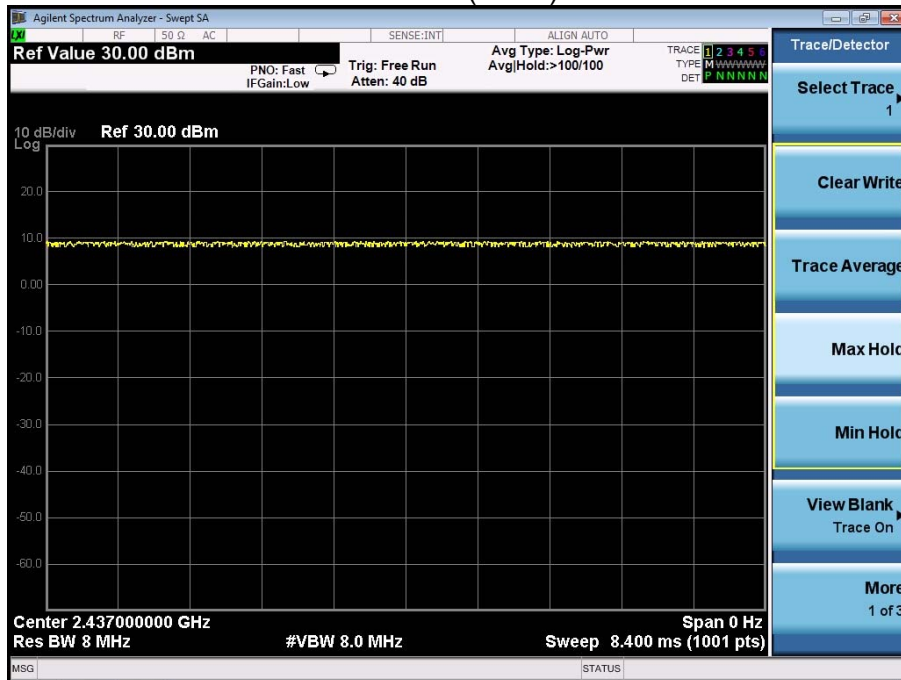



802.11n(HT40)

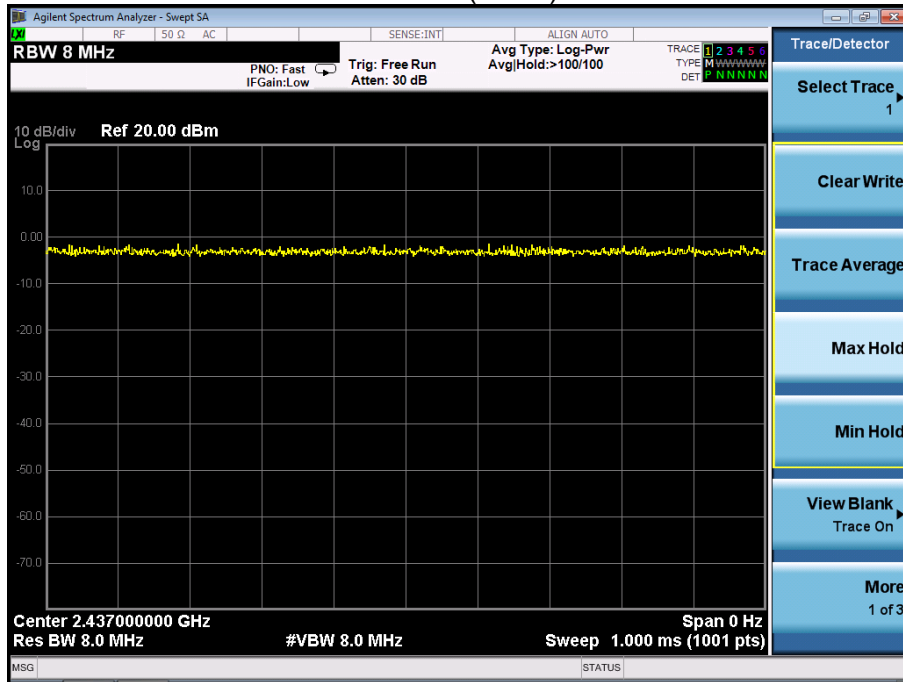

9. ANTENNA REQUIREMENT

9.1 STANDARD REQUIREMENT

15.203 requirement: For intentional device, according to 15.203: an intentional radiator shall be designed to ensure that no antenna other than that furnished by the responsible party shall be used with the device.

9.2 EUT ANTENNA

The EUT antenna is PCB antenna, It comply with the standard requirement.



10. EUT TEST PHOTO

Conducted Measurement Photos





Radiated Measurement Photos

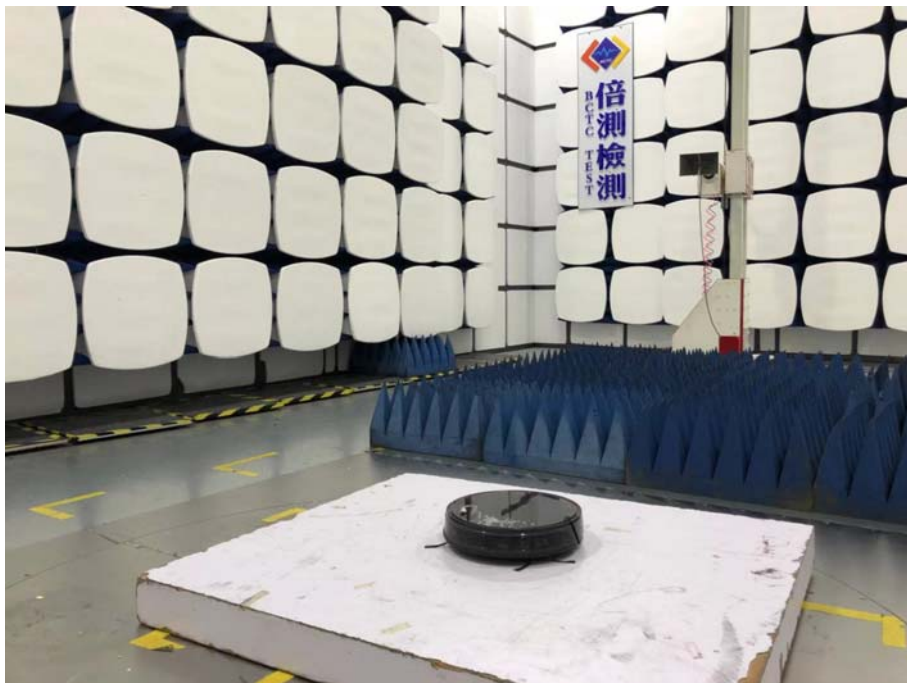



11. EUT PHOTO



※※※※※ END OF REPORT ※※※※※