



ARA-5090WF-E User Manual

MP3/WMA/USB/AUX/Bluetooth
CD player with AM/FM Radio



- Please read these instructions carefully before using this product and save this manual for future use.
- The illustrations and pictures in this manual may differ with the actual design of the product.
- The design and specifications of this product may change without prior notification for product improvement.

Contents

Before using

Precautions	2
-------------------	---

Using

Location of controls	4
Getting started	6
Radio	10
DAB (option)	12
USB player	13
AUX player	16
Bluetooth mode	17

Appendix

Troubleshooting	21
Specifications	23

Before using

Precaution

▶ Safety information

WARNING!

TO REDUCE THE RISK OF FIRE OR ELECTRIC SHOCK, DO NOT EXPOSE THIS PRODUCT TO RAIN OR MOISTURE.

TO REDUCE THE RISK OF FIRE OR ELECTRIC SHOCK AND ANNOYING INTERFERENCE, USE ONLY THE INCLUDED COMPONENTS.

▶ Handling precautions for safety

Part 15 of the FCC Rules

FCC Warning:

Any unauthorized changes or modifications to this equipment will void the user's authority to operate this device.

This equipment has been tested and found to comply with the limits for a Class 1 laser product, pursuant to Part 15 of the FCC Rules.

These limits are designed to provide reasonable protection against harmful interference in a residential installation. This equipment generates, uses and can radiate radio frequency energy and, if not installed and used in accordance with the instructions, may cause harmful interference to radio communications. However there is no guarantee that interference will not occur in a particular installation. If this equipment does cause harmful interference to radio reception, which can be determined by turning the equipment off or on, the user is encouraged to consult the dealer or an experienced radio technician for help.

Precaution

▶ Handling precautions for safety

When Driving

Keep the volume level low enough to be aware of road and traffic conditions.

When Washing Your Car

Do not expose the product, including the speakers and CDs, to water or excessive moisture. This could cause electrical short, fire, or other damage.

When Parked

Parking in direct sunlight can produce very high temperatures inside your car. Give the interior a chance to cool down before switching the unit on.

Use the Proper Power Supply

This product is designed to operate with a DC 24 V, negative-ground battery system.

Use Authorized Service Centers

This product is made of precision parts. Do not attempt to disassemble or adjust any parts. Please refer to the Service Center list included with this product for service assistance.

For Installation

This product should be installed in a horizontal position with the front end up at a convenient angle, but not more than 30°.

Note:

The preset memory is cleared to return to the original factory setting when the power connector or battery is disconnected.

- This unit is designed for DC 24 V negative-ground vehicles only. Do not use a non-standard power supply.



- Do not use gasoline, thinner, benzene, organic solvent, etc., to clean the unit.



- Do not forcibly press function buttons. By pressing lightly, damage can be avoided.

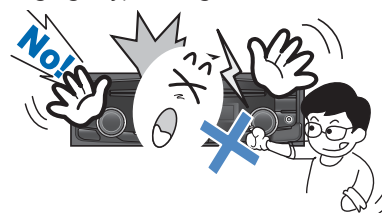

Before using

Location of controls

Front view



Usage

- ❶ **BAND** button: selects AM/FM Radio mode
- ❷ **(Call)** button: accept incoming a call or enter the call log mode (press); switch between handsfree and private call modes (press and hold)
- ❸ **MODE** button: selects USB, Bluetooth audio or AUX play mode (press)
- ❹ **DAB** button (option for DAB service region only): selects DAB mode or switch between DAB service or ensemble mode (press)
- ❺ **POWER** button with **VOLUME** dial: turns power on, mute function on/off or selects a menu item (press); turns power off and shows clock (press and hold); control the volume level or menu items
- ❻ Display window for Play/Reception/Menu state and information.
- ❼ **PRESET** [1 II] ~ [6 D+] buttons
 - Radio/DAB: Recall each stored station (press); store each station (press and hold)
- ❽ **ENTER/AST** button with **ENTER/AST TUNE** dial
- Radio/DAB: plays radio frequencies with superior reception for 5 seconds each (press); saves frequencies with superior reception to Preset buttons (press and hold); selects reception frequency manually (rotate).
- USB/Bluetooth audio: scans beginning parts (approx. 10 seconds) of tracks (press); moves to the previous/next track (rotate); rewind or fast-forward the track (rotate and hold).
- ❾ **MENU** button: enters Menu setting mode (press)
- ❿ **(End)** button: reject incoming a call or ends a call (press)
- ⓫ **USB** port with cover for plugging the USB device.

Location of controls

▶ Display window

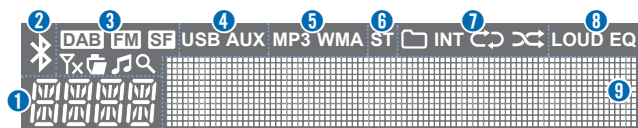

- ❶ **Function display area** for showing the function mode.
- ❷ **Bluetooth** indicator for the Bluetooth connection.
- ❸ **DAB mode** indicator for the DAB function mode.
 - : Digital signals are not received
 - : Ensemble name display
 - : Service name display
 - : Search mode
- ❹ **USB/AUX** indicators for the External device connection.
- ❺ **MP3/WMA** indicators for USB's Audio Stream detections.
- ❻ **ST (Stereo)** indicator for FM stereo reception.
- ❼ **Playback mode** indicators for USB playback mode.
 - : Folder mode
 - **INT**: Intro playback
 - : Repeat playback
 - : Random playback
- ❽ **LOUD/EQ** indicators for sound effect.
 - **LOUD**: Loudness mode
 - **EQ**: EQ mode
- ❾ **Multi-function** display area for showing the play, reception or menu information.

▶ Rear view/Connectors

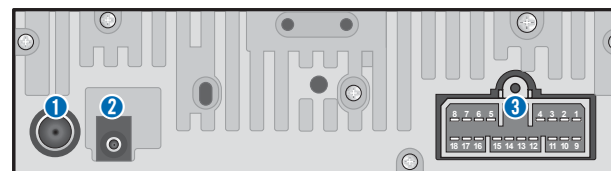

- ❶ **Antenna jack**: To plug the FM antenna cable.
- ❷ **DAB Antenna jack**: To plug the DAB antenna cable.
- ❸ **I/O connector**: To plug the I/O cable.

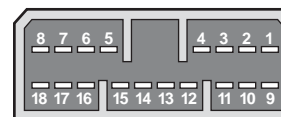

- | | |
|-------------------|------------------------------------|
| 1. Backup B (+) | 8. CAN Signal (-) |
| 2. Ground | 9. ACC B (+) |
| 3. N.C | 10. Illumination (+) |
| 4. N.C | 11. External Microphone (+) |
| 5. N.C | 12. External Microphone (-) |
| 6. N.C | 13. N.C |
| 7. CAN Signal (+) | 14. External Microphone Ground |
| | 15. Rear Right Channel Speaker (+) |
| | 16. Rear Right Channel Speaker (-) |
| | 17. Rear Left Channel Speaker (+) |
| | 18. Front Left Channel Speaker (-) |

Usage

Getting started

▶ Turning the unit on/off



- 1 Turn your car's ignition key to **ACC** or **IGN (ON)** position.
 - Displays the current time.

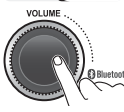

- 2 Press the **POWER** button to turn the power on.
 - If the source is ready, playback also starts.
 - **To turn on the power directly**
By connecting an USB into the USB port or pressing the **BAND, MODE** (while the USB is connected), you can also turn on the power and the unit then plays.

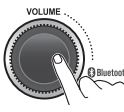

- 3 When power is on, press and hold the **POWER** button to turn power off.

▶ Adjusting volume directly



- 1 Turn the **VOLUME** dial to control volume.
 - Available volume range: 00 (mute) ~ 41.

▶ Muting the sound quickly

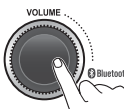

- 1 Press the **MUTE** button to turn mute on. "MUTE" will flash on the display and mute the sound.
Press the **MUTE** button again or turn **VOLUME** dial to restore sound.

▶ Setting the sound

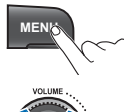

- 1 Press **MENU** button to enter the Settings menu mode.



- 2 Turn **VOLUME** dial to select the "SOUND" or "EQUALIZER" as below, then press this dial; **SOUND** ↔ **EQUALIZER** ↔ **BLUETOOTH** ↔ **DAB** ↔ **SYSTEM** ↔ **PREVIOUS** ↔ **SOUND** ...
 - **SOUND**: sets the sound mode
 - **EQUALIZER**: selects the equalizer style



- 3 Turn **VOLUME** dial to select the desired Sound setting mode, then press this dial.
 - **BASS**: sets the bass sound level. (-5 ~ +5)
 - **MIDDLE**: sets the middle sound level. (-5 ~ +5)
 - **TREBLE**: sets the treble sound level. (-5 ~ +5)
 - **BALANCE**: sets the sound balance between the right and left speakers. (LEFT 15 ~ RIGHT 15)
 - **FADER**: sets the sound fade between the front and rear speakers. (FRONT 15 ~ REAR 15)
 - **EQUALIZER**: selects the one of the 7 EQ styles (EQ OFF, POP, ROCK, COUNTRY, VOICE, JAZZ, CLASSIC).
 - **PREVIOUS**: Return to previous menu screen.



- 4 Turn **VOLUME** dial to adjust the value of the level, balance or style, then press this dial.

Getting started

▶ Setting the Bluetooth mode



- 1** During the Settings menu mode, turn **VOLUME** dial to select the "BLUETOOTH" as below, then press this dial;
SOUND ↔ EQUALIZER ↔ **BLUETOOTH** ↔ DAB ↔ SYSTEM ↔ PREVIOUS ↔ SOUND ...
- **Bluetooth**: sets the Bluetooth features



- 2** Turn **VOLUME** dial to select the desired Bluetooth setting mode, then press this dial.
- **PAIR**: register a Bluetooth device
 - **SELECT**: selects/connects a device from registered Bluetooth devices
 - **DELETE**: removes a device from registered Bluetooth device.
 - **MIC VOL**: adjusts the Bluetooth microphone volume.
 - **H/F VOL**: adjusts the Bluetooth handsfree volume.
 - **Phone Book**: download the phone book from connected device
 - **PREVIOUS**: returns to previous menu screen.



- 3** To change the connected Bluetooth device, turn the **VOLUME** dial to select the "SELECT", then press this dial.
Turn the **VOLUME** dial to select the desired device list, then press this dial.



To delete the Bluetooth device, turn the **VOLUME** dial to select the "DELETE", then press this dial.

Turn the **VOLUME** dial to select the desired device list, then press this dial.

- If the currently connected device is delete, this unit attempts to connect with the following priority Bluetooth device automatically.
- To reconnect the removed device, through the "Pairing/connecting your device" procedure can be used after the device registration.



To adjust the Bluetooth handsfree initial volume, turn the **VOLUME** dial to select the "H/F VOL", then press this dial.

Turn the **VOLUME** dial to set desired Bluetooth handsfree initial volume level, then press this dial.

- The default setting is 20, the volume range is 6 ~ 32.



To adjust the Bluetooth microphone initial volume, turn the **VOLUME** dial to select the "MIC VOL", then press this dial.

Turn the **VOLUME** dial to set desired Bluetooth microphone initial volume level, then press this dial.

- The default setting is 3, the volume range is 1 ~ 5.



To download the Phone book, turn the **VOLUME** dial to select the "Phone Book", then press this dial.

- The phone book can download up to 1,000 phone

Getting started

▶ Setting the DAB feature



- 1 During the Settings menu mode, turn the **VOLUME** dial to select the "DAB" as below, then press this dial;
SOUND ↔ EQUALIZER ↔ BLUETOOTH ↔ **DAB** ↔ SYSTEM ↔ PREVIOUS ↔ SOUND ...
 - **DAB**: sets the DAB features



- 2 Turn the **VOLUME** dial to select the "Service follow" or "Short label" as below, then press this dial;
Service follow ↔ Short label ↔ PREVIOUS ↔ Service follow ...
 - **Service follow**: activate (On) or deactivate (Off) the DAB Service follow feature.
 - **Short label**: activate (On) or deactivate (Off) the DAB Short label feature.



- 3 Turn **VOLUME** dial to activate (On) or deactivate (Off) the Service follow or Short label feature, then press this dial.
 - **Service follow On**: If the DAB's service is also provided by FM, it automatically switches to FM when the DAB service signal is weak.

▶ Setting the system functions



- 1 During the Settings menu mode, turn the **VOLUME** dial to select the "SYSTEM" as below, then press this dial;
SOUND ↔ EQUALIZER ↔ BLUETOOTH ↔ DAB ↔ **SYSTEM** ↔ PREVIOUS ↔ SOUND ...
 - **SYSTEM**: sets the system features



- 2 Turn the **VOLUME** dial to select the "BT ON/OFF", "SCROLL" or "LOUDNESS" or "BEEP" then press this dial;
BT ON/OFF ↔ AREA ↔ SCROLL ↔ LOUDNESS ↔ BEEP ↔ CLOCK ↔ SOFTWARE ↔ PREVIOUS ↔ BT ON/OFF ...
 - **BT (Bluetooth) ON/OFF**: activate (On) or deactivate (Off) the Bluetooth function.
 - **SCROLL (Scroll)**: activate (On) or deactivate (Off) the text scroll feature for LCS display screen.
 - **LOUD (Loudness)**: activate (On) or deactivate (Off) the loudness feature.
 - **BEEP (Beep)**: activate (On) or deactivate (Off) the beep sound feature.



- 3 Turn **VOLUME** dial to select ON or OFF, then press this dial.

Getting started

▶ Setting the region



- 1 During the System settings mode, turn the **VOLUME** dial to select the "AREA" as below, then press this dial;
BT ON/OFF ↔ **AREA** ↔ SCROLL ↔ LOUDNESS ↔ BEEP ↔ CLOCK ↔ SOFTWARE ↔ PREVIOUS ↔ BT ON/OFF ...

- **AREA**: sets the region for radio or DAB



- 2 Turn the **VOLUME** dial to select the desired area as below, then press this dial.

- **EUROPE**
FM: 87.5 ~ 108.0 MHz (50 kHz step)
AM: 522 ~ 1,629 kHz (9 kHz step)
- **AUSTRALIA** (option)
FM: 87.5 ~ 108.0 MHz (100 kHz step)
AM: 531 ~ 1,602 kHz (9 kHz step)
- **ASIA**
FM: 87.5 ~ 108.0 MHz (100 kHz step)
AM: 531 ~ 1,602 kHz (9 kHz step)
- **NORTH AMERICA** (option)
FM: 87.7 ~ 107.9 MHz (200 kHz step)
AM: 530 ~ 1,710 kHz (10 kHz step)
- **SOUTH AMERICA** (option)
FM: 87.5 ~ 108.0 MHz (100 kHz step)
AM: 530 ~ 1,710 kHz (10 kHz step)

Please wait for more 5 seconds with no operation, the unit will save and apply your's setting.

- If the region setting is not selected correctly to your country or region, the radio reception can not be received. Retry the setting the region of radio reception correctly.
- The region setting is required only for the first time.
- The region setting is return to the default setting when the power connector or battery is disconnected.

▶ Setting the system clock



- 1 During the System settings mode, turn the **VOLUME** dial to select the "CLOCK" as below, then press this dial;
BT ON/OFF ↔ AREA ↔ SCROLL ↔ LOUDNESS ↔ BEEP ↔ **CLOCK** ↔ SOFTWARE ↔ PREVIOUS ↔ BT ON/OFF ...

- **CLOCK**: Clock setting mode, the "24 HOUR" or "12 HOUR" will start to flash in the display.



- 2 Turn the **VOLUME** dial to select the desired clock display type, then press this dial.
 - The hour will start to flash in the display.



- 3 Turn the **VOLUME** dial to select the current hour, then press this dial.
 - The hour is set and the minutes start to flash.



- 4 Turn the **VOLUME** dial to select the current minute, then press this dial.
 - The setting is complete and clock starts.
 - This clock system can be happened the time difference about 2 ~ 3 minute at 1 month.

Getting started

▶ Checking/updating the system



- 1 During the System settings mode, turn the **VOLUME** dial to select the "SOFTWARE" as below, then press this dial;
BT ON/OFF ↔ AREA ↔ SCROLL ↔ LOUDNESS ↔ BEEP ↔ CLOCK ↔ **SOFTWARE** ↔ PREVIOUS ↔ BT ON/OFF ...
 - **SOFTWARE**: check/update the system software.



- 2 To check the system software, turn the **VOLUME** dial to select the "VERSION CHECK", then press this dial.
Turn the **VOLUME** dial to select the desired device list, then press this dial.



- To update the system software, turn the **VOLUME** dial to select the "UPDATE", then press this dial.
Download the latest system software to a USB device for update to this unit, then open the cover and plug the USB device to the USB port.

Caution

- Perform update with the start switch "ON" when the battery is sufficiently charged by driving the vehicle. When the battery is discharged while updating, the system may get damaged with the update stopped.

Radio

▶ Tuning in a radio station



- 1 Press the **BAND** button repeatedly to enter the radio band in order of FM1, FM2, FMA, AM1, AM2 or AMA.
 - You can select the FM1, FM2, AM1 or AM2 radio band.
 - While the Auto Store stations are stored, you can select the AMA or FMA band by additional.
 - The previously chosen broadcasting station will be received.



- 2 Turn the **▶▶ TUNE ◀◀** dial to select the station.
 - Briefly turn this dial, plays previous/next frequency.
 - Turn and hold this dial, automatically search for station with superior reception.
 - Press this dial, starting from the current station, stations with superior reception are scanned for 5 seconds and the previous station is restored.
 - During the seeking or scanning, if press or turn the dial left/right again, the selected station will begin playing.
 - During the FM reception, the Stereo [ST] indicator is on.

Radio

▶ Saving radio stations manually

- You can save up to 6 preset channels each for FM1, FM2, AM1 and AM2 band.
- If change the stations while driving, use preset button to prevent accidents.

 1 Press the **BAND** button repeatedly to select the band.

 2 After selecting the frequency, press and hold the **PRESET [1-6]** button.

- The frequency is saved to the selected preset button.
- A total of 24 frequencies with 6 preset frequencies each for FM1/FM2/AM1/AM2 modes can be saved.

▶ Saving radio stations automatically

- You can save up to 6 preset channels automatically each for FMA and AMA band.

 1 Press the **BAND** button repeatedly to select the band.

- The previously chosen broadcasting station will be received.

 2 Press and hold the **AST** button to automatically save receivable frequencies to Preset button.

- Up to 6 stations can be stored in each of the FMA and AMA band.

▶ Listening to a preset station

 1 Press the **BAND** button repeatedly to select the band.

- You can select the FM1, FM2, FMA, AM1, AM2 or AMA radio band.
- While the Auto Store stations are stored, you can select the FMA or AMA band by additional.
- The previously chosen broadcasting station will be received.

 2 Press the **PRESET [1-6]** button.

- From the 6 presets, select the frequency you want to listen to.

DAB (option for DAB service region)

▶ Listening to a DAB station

- 1 Press the **DAB** button to enter the DAB mode.
 - Received with the service name of the previously selected DAB broadcast displayed.
- 2 Press the **DAB** button to switch display information between the **Service name** and the **Ensemble name**.
- 3 Turn the **▶▶ TUNE ◀◀** dial to select the DAB station.
 - Briefly turn this dial, plays previous/next DAB Service station.
 - Turn and hold this dial, automatically search for DAB Ensemble station with superior reception.
 - During the searching, if press or turn the this dial again, the selected station will begin playing.
- 4 To store the DAB service or ensemble station to Preset buttons, press and hold the **PRESET [1]] ~ [6 D+]** button.
 - The station is saved to the selected preset button.
- 5 To listen to Preset station, press **PRESET [1]] ~ [6 D+]** button.
 - From the 6 presets, select the DAB station you want to listen to.

▶ Changing the DAB service

- 1 Press the **Q ENTER** button to show the DAB service list.
- 2 To change the DAB service, turn the **VOLUME** dial to select the desired Service name, then press this dial.

▶ Seeking the full Ensemble stations

- 1 Press and hold the **Q ENTER** button to automatically seek for the available Ensemble. Automatically searches for all available ensemble, then receives the first service.

USB player

▶ Handling precautions for USB device

- When using the external USB device, make sure to keep the device disconnected and connect only some time after turning on the vehicle ignition. The USB device may be damaged if the USB device already connected when the ignition is turned on. (USB device is not an electronic automotive component).
- Some USB devices may not operate properly because of compatibility issues. Check that the external device is supported by the device before starting use.
- The device will only recognize USB devices formatted in FAT 16/32. When formatting the external USB device, the device may not properly recognize a Byte/Sector selection other than 512 Bytes or 2,048 Bytes.
- Avoid the contact of bodily parts and foreign substances with the USB connector.
- Repeatedly connecting/disconnecting the USB in a short period of time may cause damage to the device.
- When disconnecting the USB, an abnormal sound may occur occasionally.
- Abruptly disconnecting the external USB device while the USB is operating may cause the device to be damaged or function abnormally. Make sure to disconnect the USB device only after the audio power is turned off or when the audio is operating in a different mode.
- The amount of time required to recognize the external USB device may differ depending on the type, size, or file formats stored on the USB. Such differences in the required time are not indications of malfunction. Please wait the period of time required to recognize the device.
- The device supports only USB devices used to play music files.
- This unit can recognize maximum 9,999 files and 256 folders into the USB device.

- Do not use the USB I/F to charge batteries or USB accessories which generate heat. Such acts may lead to deteriorated performance or damage to the device.
- The device may not recognize the USB device if separately purchased USB hubs and extension cables are being used.
- In the case of high capacity USB devices, there are instances where the logical drives are partitioned for user convenience. In this case, it will only be possible to play the USB music in the top level drive. When using partitioned drives, save the songs you wish to play on the device only in the top-level logical drive. In addition, certain USB devices are configured with a separate drive used to install application programs and it may not be possible to play songs from such drives for the reasons as described above.
- The device may not support normal operation when using formats such as HDD Type, CF, or SD Memory.
- The device will not support files locked by DRM (Digital Rights Management).
- Folder selection order/File playback order;

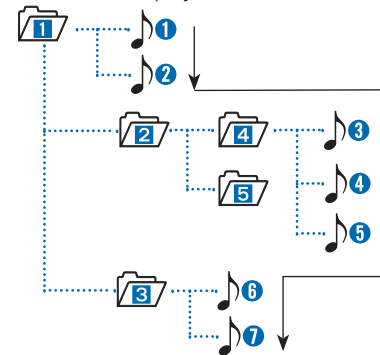

USB player

About MP3/WMA

- This unit can play MP3 (WMA) files with .mp3, .wma (lower case letters) or .MP3 and .WMA (capital letters) file name extensions.
- This unit can display ID3 Tag (Version 1.0, 1.1, 2.2, 2.3 or 2.4) information for MP3 files, such as the album name and the artist.
- This unit can display English or Korean characters.
- This unit can playback MP3/WMA files meeting the conditions below:
 - Bit rate: 8 kbps ~ 320 kbps / VBR for MP3
 - Sampling frequency:
 - 48 kHz, 44.1 kHz, 32 kHz (for MPEG-1 Layer 2/3)
 - 24 kHz, 22.05 kHz, 16 kHz (for MPEG-2 Layer 2/3)
 - 12 kHz, 11.025 kHz, 8 kHz (for MPEG-2.5 Layer 3)
 - MP3 (WMA) discs made in ISO-9660 level 1/2, Romeo, Joliet or Windows long file name system.
- The file/folder names that can be used per disc storage type are as follows, including the four-digit file name extensions (.mp3).
 - ISO 9660 Level 1: Maximum of 12 characters
 - ISO 9660 Level 2: Maximum of 31 characters
 - Romeo: Maximum of 128 characters (1 byte)
 - Joliet: Maximum of 64 characters (1 byte)
 - Windows long file name: Maximum of 28 characters (1 byte)
- This unit can playback files recorded in VBR (variable bit rate). Files recorded in VBR have a discrepancy in elapsed time display, and do not show the actual elapsed time. After performing the search function, this difference becomes noticeable.

Playing an USB device



- 1 Open the cover, plug the USB device to the USB port.
 - Once a USB is connected, USB will automatically start playing from the first file within the USB.
 - If a previously played USB is reconnected, then the file after the most recently played file is played.

- If a different USB is connected or the file information within the USB was changed, then the USB will start playing from the first song within the USB.



- 2 When an USB device to be played is already connected, press the **USB** button to play USB device.
 - The previously selected file is played.



- 3 While playing, press the **[1||]** button to pause the file.
 - Press the button again to play the current file.

Changing the song information



- 1 Press the **[4 INFO]** button repeatedly to display information about the file being played.
 - The information displayed includes the file name, playing time, ID3 Tag or folder name information saved with the song.
 - If there is no information on the playing file, then the unit will display "NO INFO".

USB player

▶ Controlling the playback



1 While playing, turn the **▶▶ TRACK ◀◀** dial left/right to moves to the previous or next track.

- Clockwise: move to the next file
Counter-clockwise: move to the previous file
- You can skip files within the same folder.



2 While the **▶▶ TRACK ◀◀** dial is being turned and held, the file will rewind or fast forward at high speed. Once released, the file will begin playing at normal speed.

- Clockwise: fast forward
Counter-clockwise: fast rewind
- The search function works but search speed is not constant.
- While fast forwarding or rewinding, you can only hear intermittent sounds.

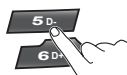

3 Press the **[5 D-]** or **[6 D+]** button to moves to the previous or next folder.

- **[5 D-]**: move to previous folder
[6 D+]: move to next folder
- While folder moving, the folder name will be displayed briefly.

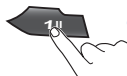

4 While playing, press the **[1 II]** button to pause the track.

- Press the button again to play the current track.

▶ Change the playback mode

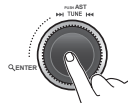

1 While playing, press the **ENTER** button to begin the Intro scan playback.

- When pressed shortly, scans the beginning parts of device files. (approx. 10 seconds per file)
- **INT** : Successively plays the intro of the file in the USB device.
- **INT** : Successively plays the intro of the file in the current folder.
- **Off** : Cancels intro playback.



2 Press the **[2 RPT]** button to select the Repeat playback mode.

- **REPEAT** : The current file plays repeatedly.
- **REPEAT** : The current folder plays repeatedly.
- **Off** : Cancels repeat playback.



3 Press the **[3 RDM]** button to select the Random playback mode.

- **RANDOM** : All files of current folder play in random order.
- **RANDOM** : All files of USB device play in random order.
- **Off** : Cancels random playback.

AUX player

▶ Listening to auxiliary audio equipment

- By connecting an optional portable audio device to the AUX input jack (stereo mini jack) on the unit and then simply selecting the source, you can listen on your car speakers.



1 Turn the **VOLUME** dial left to decrease the volume level.

- The AUX volume can also be controlled separately through the connected device.

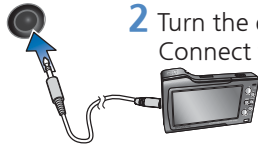

2 Turn the external audio equipment off. Connect the audio output of the external audio equipment to **AUX** input terminal on the the unit.

3 Turn the external audio equipment on. Start playback of the external audio equipment at a moderate volume.



4 Press the **MODE** button to select the AUX function.



5 Set your usual listening volume by turn the **VOLUME** dial left/right on the unit.

- Once the connector is disconnected, the previous mode will be restored.
- AUX mode can be used only when an external audio player has been connected.

▶ Handling precautions for AUX

- All external devices should be turned off before ignition is turned off and should not be reconnected until the vehicle has been turned on.
- If only cable connected to the AUX without an external device, the mode changed to AUX, but noise may occur. When an external device is not being used, remove the connector jack.
- When the external device power is connected to the power jack, playing the external device may output noise. In such cases, disconnect the power connection before use.

Bluetooth

▶ About Bluetooth wireless technology

- Bluetooth® Wireless Technology refers to a short-distance wireless networking technology which uses a 2.45GHz frequency to connect various devices within a certain distance.
- The Bluetooth function can be used only if a Bluetooth device has been connected. Pairing and connection of Bluetooth devices, refer to "Pairing/Connecting Your Bluetooth device."
- When your Bluetooth device is connected, "📶" is displayed on the display. If "📶" does not appear, because it does not have the Bluetooth connection status before using the connection.
- To be able to set up a Bluetooth pairing and connection to this unit, the Bluetooth function of your Bluetooth device must be activated. (Bluetooth function setting method may vary depending on the device, For further information, please consult the user guide of the Bluetooth device.)
- If the Bluetooth device is to be connected together with another Bluetooth device (MP3 player, mobile phone, digital camera, etc. via USB/AUX port), this unit may not operate properly.
- Some features may not be supported by some Bluetooth devices specification.
- Bluetooth functions can be operated to some unstable depending on the communication status.
- The hands-free call volume and quality may differ depending on the device.
- While driving, please refrain from Bluetooth-related menu operation for safety reasons.
- Up to 5 devices can be paired to this unit. Only one paired device can be connected to this unit at a time.

- The Bluetooth device is connected, you can not register other devices.
- Only supports Bluetooth hands-free and Bluetooth audio related functions.
- If your Bluetooth device is turned off abnormally connected, the Bluetooth connection, search for the Bluetooth device to connect to automatically. (Communication device powered off or out of range, Bluetooth communication error, etc.)
- If you do not want to turn off the automatic connection of Bluetooth devices, turn the Bluetooth function off.

▶ About Bluetooth music mode

- Bluetooth Audio mode can be used only if a Bluetooth Audio device has been connected.
- If the Bluetooth device is disconnected while Bluetooth music is active, then the music will also stop.
- During the track up/down from the Bluetooth music playback status, some device can be output pop noise and sound broken
- During a phone call from the Bluetooth music playback status, some phone can be output mixed with the phone sound.
- End the phone call and returning to a Bluetooth music mode, some mobile phones may not be played automatically.
- Bluetooth hands-free and Bluetooth music functions can not be used simultaneously. (While the Bluetooth music playback, if you enter the phone features, Bluetooth music playback will end).

Bluetooth

▶ Pairing/Connecting your device

- Firstly, set up the Bluetooth device to be connected from the Bluetooth settings menu to enable other devices to search for the Bluetooth device.



1 Press **MENU** button to enter the Menu settings mode.



2 Turn **VOLUME** dial to select the "BLUETOOTH" as below, then press this dial;
SOUND ↔ EQUALIZER ↔ **BLUETOOTH** ↔ DAB ↔ SYSTEM ↔ PREVIOUS ↔ SOUND ...
• BLUETOOTH: Bluetooth setting mode



3 Turn the **VOLUME** dial to select the "PAIR", then press this dial.
When you first register, appear the "BT Pairing" on the display window, then search the Bluetooth devices for connection.



4 Search and select device "Doosan" in the Bluetooth menu.
Confirm this on your device.
• The Bluetooth registration standby proceeds for 1 minute. If the registration is failed during 1 minute, restart over from the beginning.



5 After a while, the Bluetooth device is automatically registered.
When pairing is successful, the "Connected" and "Device name" will be displayed 3

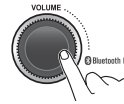

seconds.

- When your Bluetooth device is connected, "BT" appear on the display. If the Bluetooth device is disconnected, "BT" disappear.

6 Repeat items 1~ 4 to register to add another Bluetooth device.
• Up to 5 devices can be paired to this unit.
• The last device connected to this unit is set to automatically connect to the highest priority.

▶ Playing the Bluetooth music

To play Bluetooth music

- This function only operates with Bluetooth devices that support A2DP (Advanced Audio Distribution Profile) version 1.2 or above.
- Should be set to Stereo Headst in Bluetooth device type menu of your device.
- Do not connect the your mobile phone to a USB port. It can cause an error in the Bluetooth music play mode



1 Press the **MODE** button repeatedly to select the BT Audio mode. Appears "BT" on display window and start playback.
• If a Bluetooth device is not connected, you can not select.
• If music is not yet playing from your mobile device after switching to Bluetooth Music (streaming audio) mode or after pressing Play on the mobile device itself, try to start music playback by pressing the Play button again.

Bluetooth

- The output music playback from Bluetooth devices with this unit.
- There will be music playback automatically play upon entering since once played, it stops automatically when you exit from the music.
- You can also phone or Bluetooth device other than the home screen mode, Bluetooth music play mode when entering and exiting, the device does not play automatically.

▶ Controlling the playback



- 1 While playing, turn the **TRACK** dial to move to the previous or next track.
 - Clockwise: move to the next file
 - Counter-clockwise: move to the previous file
 - You can skip files within the same folder.
 - During Bluetooth music playback, do not operate the music changes too quickly. Allow enough time for the machine-to-machine communication.

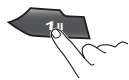

- 2 While playing, press the **[1 II]** button to pause the track with "PAUSE" indicator.
 - Press this button again to play the current track.



- 3 Press the **[4 INFO]** button to check the information of current connected device.
 - About the music files are not displayed.

▶ Answering a call

- When a call comes in, the audio source is muted, and display the call information with ring tone.
- If the phonebook is not downloaded, incoming phone numbers are not displayed.



- 1 To answer a call, press the **(Call)** button or to reject a call press the **(End)** button.
 - When a call comes in, the audio source is muted.
 - When a call is ended, this unit returns to the previous state media playback.

▶ Making a call by reentry



- 1 To make a call, press the **(Call)** button to display recent call number.
 - When a call mode is active, the audio source is muted.



- 2 Turn the **VOLUME** dial to select a recent call number, then press this dial to make a call.
 - The recent calls list displays up to 10.

Bluetooth

▶ During a call...

Usage



1 To adjust the a call volume, turn the **VOLUME** dial.

- The call volume works with Bluetooth devices, and operates separately from the volume of this unit.

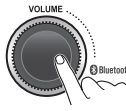

2 To deactivate the microphone, press the **MUTE** button.

- To reactivate the microphone, press **MUTE** button.



3 To switch from handsfree mode to the phone handset mode, press the **(Call)** button.

To returns the phone conversation to hands-free mode, press the **(Call)** button.

4 Call wating feature

When a new call comes in during a call, "Call in" and the incoming call information are displayed alternately.



To wait for the first call and connect the second call, press and hold the **(Call)** button.



To end the first call and connect the second call, press the **(Call)** button.



To keep the first call and decline the second, press and hold the **(End)** button.

5 To end a call, press the **(End)** button.

- End a call, then return to the playing state.

Troubleshooting

▶ Common

Symptoms	Possible causes	Possible remedies
• Sound is not generated.	• MUTE is set to ON.	• Set MUTE to OFF. (refer to 7 page)
• Noise	• There is an electromagnetic-wave generator such as a cellular phone near the unit or its electrical lines.	• Keep an electromagnetic-wave generator such as a cellular phone away from the unit and the wiring of the unit. In case the noise cannot be eliminated due to the wiring harness of the car, consult your dealer.
• No sound from speaker(s)	• Balance/fader setting is not appropriate.	• Readjust balance/fader. (refer to 7 page)

▶ Radio/DAB (option)

Symptoms	Possible causes	Possible remedies
• A radio broadcast cannot be received.	• The region of radio reception is not selected correctly.	• Retry the setting the region of radio reception correctly. (Refer to page 9)
• Poor reception or noise	• The auto antenna (aerial) will not go up.	• Check the connection of the power antenna (aerial) control lead.
• Seeking takes too long.	• The number of receivable stations is less than 6.	• Move to an area where receivable stations number is maximum, and try presetting.
• The number of auto preset stations is less than 6.	• The contact of the battery lead is poor, or the battery lead is not always powered.	• Make sure that the battery lead is connected securely, and preset stations again.
• Preset stations cannot be stored.	• Digital seeking may take some time.	• Change to auto seeking, and proceed with seeking again.

Troubleshooting

▶ USB

Symptoms	Possible causes	Possible remedies
• The USB does not work	• USB memory is damaged.	• Please use after formatting the USB into FAT 16/32 format.
	• USB memory has been contaminated.	• Remove any foreign substances on the contact surface of the USB memory and USB port.
	• A separately purchased USB HUB is being used.	• Directly connect the USB memory with the USB port.
	• A USB extension cable is being used.	• Directly connect the USB memory with the USB port.
	• A USB which is not a Metal Cover Type USB Memory is being used.	• Use a standard USB Memory.
	• A HDD type, CF, SD Memory is being used.	• Use a standard USB Memory.
	• There are no music files which can be played.	• Only MP3, WMA file formats are supported. Please use only the supported music file formats.

Specifications

▶ General section

Power supply	DC 24 V (Negative Ground)
Speaker	4 Ohm (4 Speaker)
Power	20 Watts X 4 CH = 80 Watts

▶ FM/AM Radio section

Frequency range	FM: 87.5 ~ 108.0 MHz, AM: 522 ~ 1,629 kHz (refer to 9 page "Setting the region")
Usable sensitivity	FM: 12 dBu, S/N: 30 dB AM: 33 dBu, S/N: 20 dB
S/N	FM: 50 dB / AM: 45 dB
Stereo separation	FM: 30 dB (1 KHz)

▶ USB section

Frequency range	20 Hz ~ 20 KHz
T.H.D	0.1 % (at 1 KHz)
Dynamic Range	85 dB (at 1 KHz)
S/N	50 dB (at 1 KHz)
Channel separation	40 dB (at 1 KHz)

▶ Bluetooth section

Version	2.0
Sensitivity	-60 dBm
Function/Profile	Supported Higher Bandwidth Audio, Advanced Audio Distribution Profile (Sound playback capabilities within Bluetooth-compatible devices), Hands-Free Profile

FCC Information to User

This equipment has been tested and found to comply with the limits for a Class B digital device, pursuant to Part 15 of the FCC Rules. These limits are designed to provide reasonable protection against harmful interference in a residential installation. This equipment generates, uses and can radiate radio frequency energy and, if not installed and used in accordance with the instructions, may cause harmful interference to radio communications. However, there is no guarantee that interference will not occur in a particular installation. If this equipment does cause harmful interference to radio or television reception, which can be determined by turning the equipment off and on, the user is encouraged to try to correct the interference by one of the following measures:

- Reorient or relocate the receiving antenna.
- Increase the separation between the equipment and receiver.
- Connect the equipment into an outlet on a circuit different from that to which the receiver is connected.
- Consult the dealer or an experienced radio/TV technician for help.

Caution

Modifications not expressly approved by the party responsible for compliance could void the user's authority to operate the equipment.

English:

This device complies with Industry Canada ' s license - exempt RSSs. Operation is subject to the following two conditions:

- (1) This device may not cause interference; and
- (2) This device must accept any interference, including interference that may cause undesired operation of the device.

French:

Le pr sent appareil est conforme aux CNR d'Industrie Canada applicables aux appareils radio exempts de licence. L'exploitation est autoris e aux deux conditions suivantes : (1) l'appareil ne doit pas produire de brouillage, et (2) l'utilisateur de l'appareil doit accepter tout brouillage radio lectrique subi, m me si le brouillage est susceptible d'en compromettre le fonctionnement.

FCC Compliance Information : This device complies with Part 15 of the FCC Rules. Operation is subject to the following two conditions: (1) This device may not cause harmful interference, and (2) this device must accept any interference received, including interference that may cause undesired operation

IMPORTANT NOTE:

FCC RF Radiation Exposure Statement:

This equipment complies with FCC RF radiation exposure limits set forth for an uncontrolled environment. This equipment should be installed and operated with a minimum distance of 20 centimeters between the radiator and your body. This transmitter must not be co-located or operating in conjunction with any other antenna or transmitter.

specification

Kind of product	Bluetooth Audio
Model Name	ARA-5090WF-E
Power supply	DC 24V
Frequency range	2 402 MHz ~ 2 480 MHz
Modulation technique	GFSK, Pi/4DQPSK, 8DPSK
Number of channels	79 ch
Operating conditions	- 20°C~ + 50°C
Antenna gain	0.5 dB i (Max.)
maximum power	-9.87 dBm

ARA-5090WF-E

