

TEST REPORT

ACCORDING TO: FCC 47CFR part 15 subpart C §15.247 (DTS) and subpart B,
RSS-247 Issue 2:2017, RSS-Gen Issue 5, ICES-003 Issue 7:2020

FOR:

Essence Smartcare Ltd.

Control Panel

Model: ES8502HC_B

FCC ID: 2ARFP-ES8502HC-B

IC: 24417-ES8502HCB

This report is in conformity with ISO/IEC 17025. The "A2LA Accredited" symbol endorsement applies only to the tests and calibrations that are listed in the scope of Hermon Laboratories accreditation. The test results relate only to the items tested.
This test report shall not be reproduced in any form except in full with the written approval of Hermon Laboratories Ltd.

Table of contents

1	Applicant information.....	3
2	Equipment under test attributes	3
3	Manufacturer information	3
4	Test details.....	3
5	Tests summary.....	4
6	EUT description.....	5
6.1	General information.....	5
6.2	Test configuration.....	5
6.3	Changes made in EUT	5
6.4	Transmitter characteristics	6
7	Transmitter tests according to 47CFR part 15 subpart C and RSS-247 requirements.....	7
7.1	Minimum 6 dB bandwidth	7
7.2	Peak output power	12
7.3	Field strength of spurious emissions	17
7.4	Band edge radiated emissions	42
7.5	Peak spectral power density	45
7.6	Conducted emissions	50
7.7	Antenna requirements.....	54
8	Emissions tests according to FCC 47CFR part 15 subpart B and ICES-003 requirements.....	55
8.1	Conducted emissions	55
8.2	Radiated emission measurements	59
9	APPENDIX A Test equipment and ancillaries used for tests.....	63
10	APPENDIX B Test equipment correction factors.....	64
11	APPENDIX C Measurement uncertainties	66
12	APPENDIX D Test laboratory description	67
13	APPENDIX E Specification references.....	67
14	APPENDIX F Abbreviations and acronyms.....	68

1 Applicant information

Client name: Essence Smartcare Ltd.
Address: 12 Abba Eban avenue, Ackerstein Tower Bldg. D, P.O.Box 2073, Herzliya 4612001, Israel
Telephone: +972 732 447 735
Fax: +972 9772 9962
E-mail: israelgo@essence-grp.com
Contact name: Mr. Israel Gottesman

2 Equipment under test attributes

Product name: Control Panel
Product type: Transceiver
Model(s): ES8502HC_B
Serial number: 001
Hardware version: 2.A
Software release: 8.1
Receipt date 29-Mar-22

3 Manufacturer information

Manufacturer name: Essence Smartcare Ltd.
Address: 12 Abba Eban avenue, Ackerstein Tower Bldg. D, P.O.Box 2073, Herzliya 4612001, Israel
Telephone: +972 732 447 735
Fax: +972 9772 9962
E-Mail: israelgo@essence-grp.com
Contact name: Mr. Israel Gottesman

4 Test details



Project ID: 47160
Location: Hermon Laboratories Ltd. P.O. Box 23, Binyamina 3055001, Israel
Test started: 29-Jun-22
Test completed: 21-Jul-22
Test specification(s): FCC 47CFR part 15 subpart C §15.247 (DTS) and subpart B, RSS-247 Issue 2:2017, RSS-Gen Issue 5, ICES-003 Issue 7:2020

5 Tests summary

Test	Status
Transmitter characteristics	
FCC section 15.247(a)2 / RSS-247 section 5.2(1), 6 dB bandwidth	Pass
FCC section 15.247(b)3/ RSS-247 section 5.4(4), Peak output power	Pass
FCC section 15.247(i) / RSS-102 section 2.5.2, RF exposure	Pass, the exhibit to the application of certification is provided
FCC section 15.247(d) / RSS-247 section 5.5, Radiated spurious emissions	Pass
FCC section 15.247(d)/ RSS-247 section 5.5, Emissions at band edges	Pass
FCC section 15.247(e) / RSS-247 section 5.2(2), Peak power density	Pass
FCC section 15.207(a) / RSS-Gen section 8.8, Conducted emission	Pass
FCC section 15.203 / RSS-Gen section 6.8 Antenna requirement	Pass
Unintentional emissions	
FCC section 15.107/ ICES-003, Section 6.1, Class B, Conducted emission	Pass
FCC section 15.109/ RSS-Gen section 7.1.2 /ICES-003, Section 6.2, Class B, Radiated emission	Pass

This Test Report supersedes the previously issued Test Report identified by Doc ID: ESSRAD_IC.47160_DSS and ESSRAD_FCC.47160_DSS_Rev1

Testing was completed against all relevant requirements of the test standard. The results obtained indicate that the product under test complies in full with the requirements tested.
The test results relate only to the items tested. Pass/ fail decision was based on nominal values.

	Name and Title	Date	Signature
Tested by:	Mrs. E. Pitt, test engineer, EMC & Radio	29-Jun-22 – 21-Jul-22	
Reviewed by:	Mrs. S. Peysahov Sheynin, test engineer, EMC & Radio	29-Dec-22	
Approved by:	Mr. M. Nikishin, group leader, EMC & Radio	29-Dec-22	

6 EUT description

Note: The following data in this clause is provided by the customer and represents his sole responsibility

6.1 General information

The EUT is an ES8502HC_B Control Panel, powered via external AC/DC adaptor, comprises two radio modules, operating simultaneously:

- 916.5MHz, FSK modulation
- TX/Rx 2.4GHz (BLE)

6.2 Test configuration

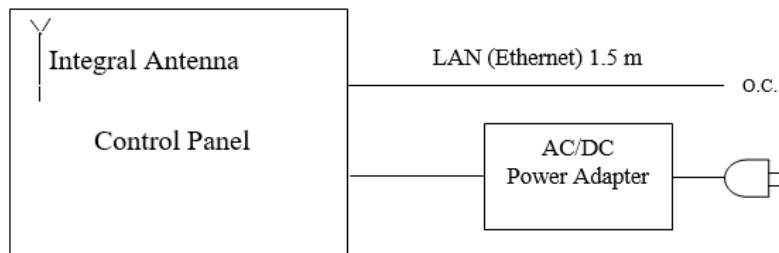

6.3 Changes made in EUT

No changes were implemented in the EUT during testing.



6.4 Transmitter characteristics

Type of equipment						
X	Stand-alone (Equipment with or without its own control provisions)					
	Combined equipment (Equipment where the radio part is fully integrated within another type of equipment)					
	Plug-in card (Equipment intended for a variety of host systems)					
Intended use			Condition of use			
	fixed	Always at a distance more than 2 m from all people				
X	mobile	Always at a distance more than 20 cm from all people				
	portable	May operate at a distance closer than 20 cm to human body				
Assigned frequency range		2400-2483.5 MHz				
Operating frequency range		2402 MHz, 2440 MHz, 2480 MHz				
Maximum rated output power		At transmitter 50 Ω RF output connector		NA		
		Peak output power		16.97 dBm		
Is transmitter output power variable?		X	No			
			Yes	continuous variable		
				stepped variable with stepsize		
				minimum RF power		
		maximum RF power				
Antenna connection						
	unique coupling	standard connector	X	integral	with temporary RF connector	
					without temporary RF connector	
Antenna/s technical characteristics						
Type	Manufacturer	Model number		Gain		
Printed	Essence Security	NA		3 dBi		
Data rate		2 Mbps				
Modulating test signal (baseband)		GFSK				
Transmitter power source						
	Battery	Nominal rated voltage	VDC	Battery type		
	DC	Nominal rated voltage	VDC			
X	AC mains	Nominal rated voltage	110 VAC	Frequency	60 Hz	



Test specification: FCC section 15.247(a)2, RSS-247 section 5.2(1), 6 dB bandwidth			
Test procedure: ANSI C63.10, section 7.8.7			
Test mode: Compliance		Verdict: PASS	
Date(s): 04-Jul-22			
Temperature: 24 °C	Relative Humidity: 63 %	Air Pressure: 1010 hPa	Power: 110 VAC, 60 Hz
Remarks:			

7 Transmitter tests according to 47CFR part 15 subpart C and RSS-247 requirements

7.1 Minimum 6 dB bandwidth

7.1.1 General

This test was performed to measure 6 dB bandwidth of the EUT carrier frequency. Specification test limits are given in Table 7.1.1 and Table 7.1.2

Table 7.1.1 The 20 dB bandwidth limits

Assigned frequency, MHz	Modulation envelope reference points*, dBc	Minimum bandwidth, kHz
902.0 – 928.0	6.0	500.0
2400.0 – 2483.5		
5725.0 – 5850.0		

* - Modulation envelope reference points provided in terms of attenuation below the peak of modulated carrier.

Table 7.1.2 The 99% bandwidth limits

Assigned frequency, MHz	Modulation envelope reference points	Limit, kHz
2400.0 – 2483.5	99%	NA

7.1.2 Test procedure

7.1.2.1 The EUT was set up as shown in Figure 7.1.1 energized and its proper operation was checked.

7.1.2.2 The EUT was set to transmit modulated carrier.

7.1.2.3 The transmitter minimum 6 dB bandwidth was measured with spectrum analyzer as frequency delta between reference points on modulation envelope and provided in Table 7.1.3 and associated plot.

Figure 7.1.1 The 6 dB bandwidth test setup





Test specification: FCC section 15.247(a)2, RSS-247 section 5.2(1), 6 dB bandwidth			
Test procedure: ANSI C63.10, section 7.8.7			
Test mode: Compliance		Verdict: PASS	
Date(s): 04-Jul-22			
Temperature: 24 °C	Relative Humidity: 63 %	Air Pressure: 1010 hPa	Power: 110 VAC, 60 Hz
Remarks:			

Table 7.1.3 The 6 dB bandwidth test results

ASSIGNED FREQUENCY BAND: 2400.0 – 2483.5 MHz
DETECTOR USED: Peak
SWEEP TIME: Auto
VIDEO BANDWIDTH: ≥ RBW
MODULATION ENVELOPE REFERENCE POINTS: 6 dBc, 99%
DATA RATE: LE_2M_prbs9

Carrier frequency, MHz	Type of modulation	Data rate, Mbps	6 dB bandwidth, kHz	Limit, kHz	Margin, kHz	Verdict
2402.0	GFSK	2.0	579.4	500.0	79.4	Pass
2440.0			707.3	500.0	207.3	Pass
2480.0			679.3	500.0	179.3	Pass

Carrier frequency, MHz	Type of modulation	Data rate, Mbps	99% BW, kHz	Limit, kHz	Margin, kHz	Verdict
2402.0	GFSK	2.0	2149.2	500.0	1649.2	Pass
2440.0			2292.1	500.0	1792.1	Pass
2480.0			2246.3	500.0	1746.3	Pass

Reference numbers of test equipment used

HL 3437	HL 4136	HL 5376	HL 5397	HL 5645				
---------	---------	---------	---------	---------	--	--	--	--

Full description is given in Appendix A.



HERMON LABORATORIES

Test specification: FCC section 15.247(a)2, RSS-247 section 5.2(1), 6 dB bandwidth			
Test procedure: ANSI C63.10, section 7.8.7			
Test mode: Compliance		Verdict: PASS	
Date(s): 04-Jul-22			
Temperature: 24 °C	Relative Humidity: 63 %	Air Pressure: 1010 hPa	Power: 110 VAC, 60 Hz
Remarks:			

Plot 7.1.1 The 6 dB and 99% bandwidth test result at low frequency at Data Rate = LE_2M_prbs9



16:28:02 27.12.2022



16:46:39 27.12.2022



HERMON LABORATORIES

Test specification: FCC section 15.247(a)2, RSS-247 section 5.2(1), 6 dB bandwidth			
Test procedure: ANSI C63.10, section 7.8.7			
Test mode: Compliance		Verdict: PASS	
Date(s): 04-Jul-22			
Temperature: 24 °C	Relative Humidity: 63 %	Air Pressure: 1010 hPa	Power: 110 VAC, 60 Hz
Remarks:			

Plot 7.1.2 The 6 dB and 99% bandwidth test result at mid frequency at Data Rate = LE_2M_prbs9



17:10:38 27.12.2022



17:16:05 27.12.2022



HERMON LABORATORIES

Test specification: FCC section 15.247(a)2, RSS-247 section 5.2(1), 6 dB bandwidth			
Test procedure: ANSI C63.10, section 7.8.7			
Test mode: Compliance		Verdict: PASS	
Date(s): 04-Jul-22			
Temperature: 24 °C	Relative Humidity: 63 %	Air Pressure: 1010 hPa	Power: 110 VAC, 60 Hz
Remarks:			

Plot 7.1.3 The 6 dB and 99% bandwidth test result at high frequency at Data Rate = LE_2M_prbs9

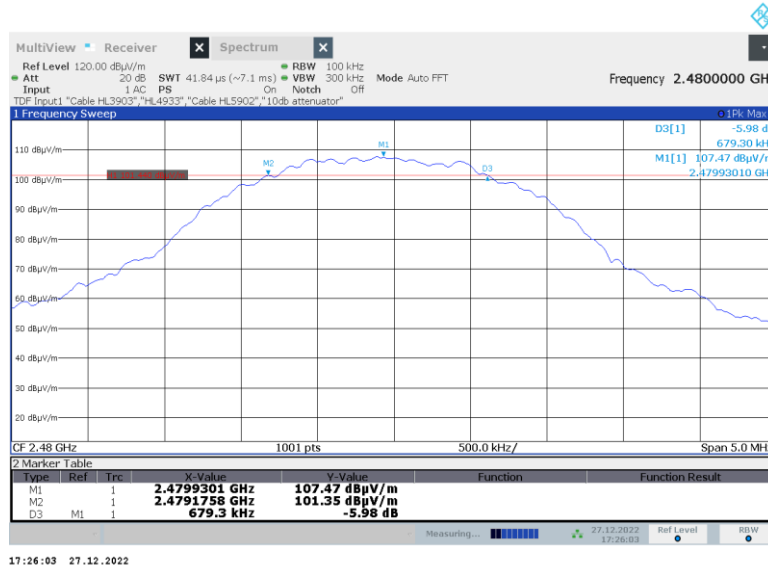

17:26:03 27.12.2022

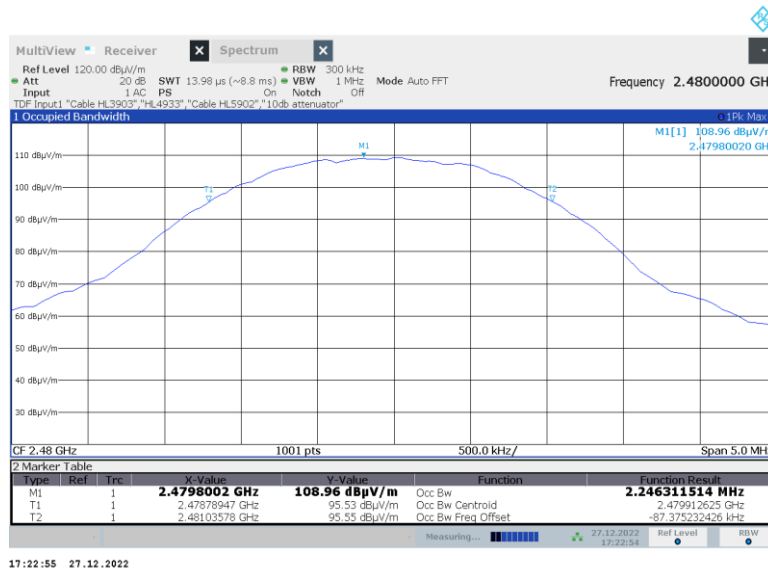

17:22:55 27.12.2022



Test specification: Section 15.247(b)3/ RSS-247 section 5.4(d), Peak output power			
Test procedure: ANSI C63.10 section 11.9.1.1			
Test mode: Compliance		Verdict: PASS	
Date(s): 08-Jul-22			
Temperature: 25 °C	Relative Humidity: 52 %	Air Pressure: 1012 hPa	Power: 110 VAC, 50 Hz
Remarks:			

7.2 Peak output power

7.2.1 General

This test was performed to measure the maximum peak output power radiated by transmitter. Specification test limits are given in Table 7.2.1.

Table 7.2.1 Peak output power limits

Assigned frequency range, MHz	Maximum antenna gain, dBi	Peak output power*		Equivalent field strength limit @ 3m, dB(μV/m)**
		W	dBm	
902.0 – 928.0	6.0	1.0	30.0	131.2
2400.0 – 2483.5				
5725.0 – 5850.0				

*- The limit is provided in terms of conducted RF power at the antenna connector. If transmitting antennas of directional gain greater than 6 dBi are used, the peak output power limit shall be reduced below the stated value as follows:

by 1 dB for every 3 dB that the directional gain of antenna exceeds 6 dBi for fixed point-to-point transmitters operate in 2400-2483.5 MHz band;
without any corresponding reduction for fixed point-to-point transmitters operate in 5725-5850 MHz band;
by the amount in dB that the directional gain of antenna exceeds 6 dBi for the rest of transmitters.

**- Equivalent field strength limit was calculated from the peak output power as follows: $E = \sqrt{(30 \times P \times G)} / r$, where P is peak output power in Watts, r is antenna to EUT distance in meters and G is transmitter antenna gain in dBi.

7.2.2 Test procedure

7.2.2.1 The EUT was set up as shown in Figure 7.2.1, energized and its proper operation was checked.

7.2.2.2 The EUT was adjusted to produce maximum available to end user RF output power.

7.2.2.3 The resolution bandwidth of spectrum analyzer was set wider than 6 dB bandwidth of the EUT and the field strength of the EUT carrier frequency was measured with antenna connected to spectrum analyzer/ EMI receiver. To find maximum radiation the turntable was rotated 360° and the measuring antenna height was swept in both vertical and horizontal polarizations.

7.2.2.4 The maximum field strength of the EUT carrier frequency was measured as provided in Table 7.2.2 and associated plots.

7.2.2.5 The maximum peak output power was calculated from the field strength of carrier as follows:

$$P = (E \times d)^2 / (30 \times G),$$

where P is the peak output power in W, E is the field strength in V/m, d is the test distance and G is the transmitter numeric antenna gain over an isotropic radiator.

The above equation was converted in logarithmic units for 3 m test distance:

$$\text{Peak output power in dBm} = \text{Field strength in dB}(\mu\text{V/m}) - \text{Transmitter antenna gain in dBi} - 95.2 \text{ dB}$$

7.2.2.6 The worst test results (the lowest margins) were recorded in Table 7.2.2.



Test specification: Section 15.247(b)3/ RSS-247 section 5.4(d), Peak output power			
Test procedure: ANSI C63.10 section 11.9.1.1			
Test mode: Compliance		Verdict: PASS	
Date(s): 08-Jul-22			
Temperature: 25 °C	Relative Humidity: 52 %	Air Pressure: 1012 hPa	Power: 110 VAC, 50 Hz
Remarks:			

Figure 7.2.1 Setup for carrier field strength measurements

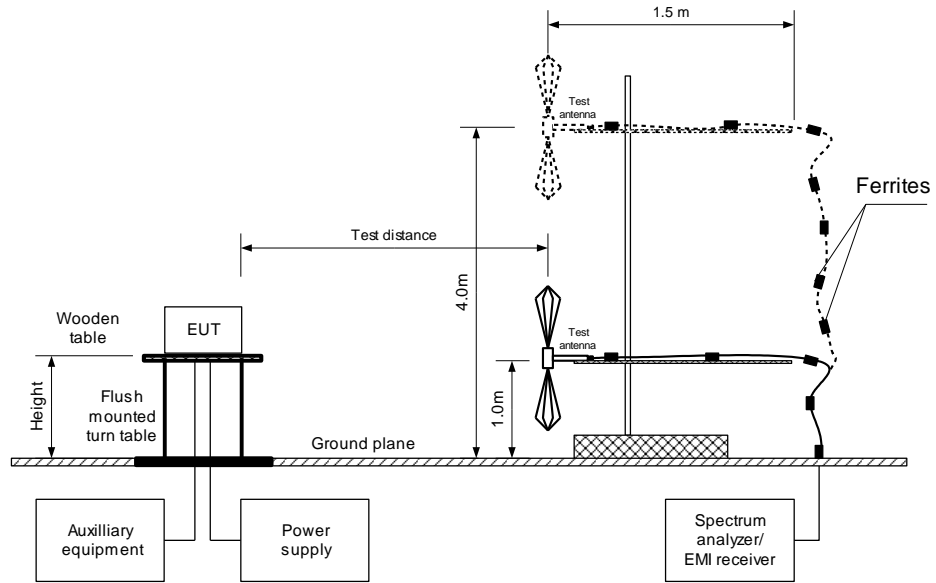



Test specification: Section 15.247(b)3/ RSS-247 section 5.4(d), Peak output power			
Test procedure: ANSI C63.10 section 11.9.1.1			
Test mode: Compliance		Verdict: PASS	
Date(s): 08-Jul-22			
Temperature: 25 °C	Relative Humidity: 52 %	Air Pressure: 1012 hPa	Power: 110 VAC, 50 Hz
Remarks:			

Table 7.2.2 Peak output power test results

ASSIGNED FREQUENCY: 2400-2483.5 MHz
TEST DISTANCE: 3 m
TEST SITE: Semi anechoic chamber
EUT HEIGHT: 1.5 m
DETECTOR USED: Peak
TEST ANTENNA TYPE: Double ridged guide (above 1000 MHz)
MODULATION: GFSK
DATA RATE: LE 2M Prob9
EUT 6 dB BANDWIDTH: 707.3 kHz
RESOLUTION BANDWIDTH: 3 MHz
VIDEO BANDWIDTH: 50 MHz
FREQUENCY HOPPING: Disabled
NUMBER OF FREQUENCY HOPPING CHANNELS: 40

Frequency, MHz	Field strength, dB(μV/m)	Antenna polarization	Antenna height, m	Azimuth, degrees*	EUT antenna gain, dBi	Peak output power, dBm**	Limit, dBm	Margin, dB***	Verdict
2402	109.69	Vertical	1.6	-20	3	11.00	30	-19.00	Pass
2440	114.62	Vertical	1.5	-16	3	16.39	30	-13.63	Pass
2480	115.22	Vertical	1.4	-9	3	16.97	30	-13.03	Pass

*- EUT front panel refer to 0 degrees position of turntable.

** - Peak output power was calculated from the field strength of carrier as follows: $P = (E \times d)^2 / (30 \times G)$,

where P is the peak output power in W, E is the field strength in V/m, d is the test distance in meters and G is the transmitter numeric antenna gain over an isotropic radiator. The above equation was converted in logarithmic units for 3 m test distance: *Peak output power in dBm = Field strength in dB(μV/m) - Transmitter antenna gain in dBi - 95.2 dB*

*** - Margin = Peak output power - specification limit.

Reference numbers of test equipment used

HL 3818	HL 3903	HL 5902	HL 4114				
---------	---------	---------	---------	--	--	--	--

Full description is given in Appendix A.



HERMON LABORATORIES

Test specification: Section 15.247(b)3/ RSS-247 section 5.4(d), Peak output power			
Test procedure: ANSI C63.10 section 11.9.1.1			
Test mode: Compliance		Verdict: PASS	
Date(s): 08-Jul-22			
Temperature: 25 °C	Relative Humidity: 52 %	Air Pressure: 1012 hPa	Power: 110 VAC, 50 Hz
Remarks:			

Plot 7.2.1 Field strength of carrier at low frequency (worst case antenna polarization)

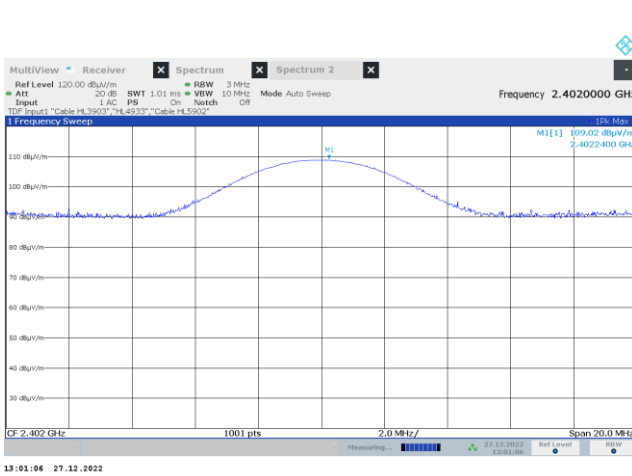

EUT Position – Horizontal

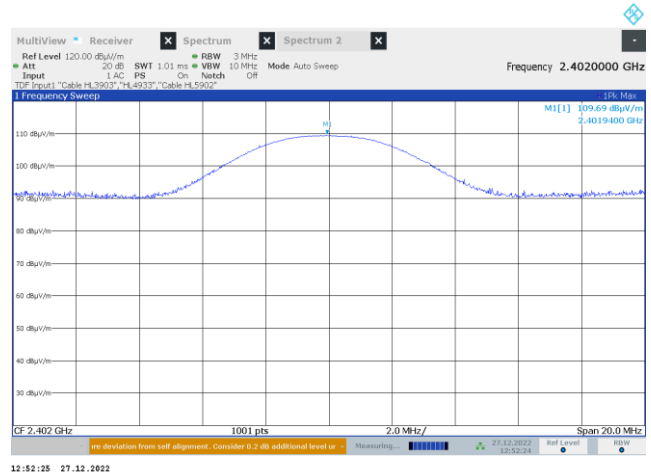

EUT Position - Vertical

Plot 7.2.2 Field strength of carrier at mid frequency (worst case antenna polarization)

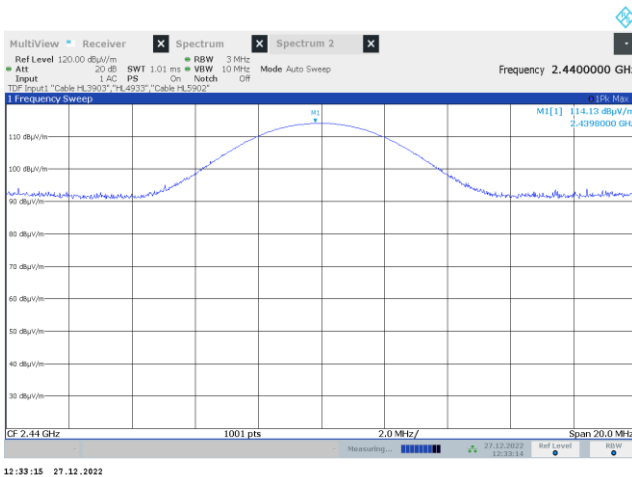

EUT Position – Horizontal

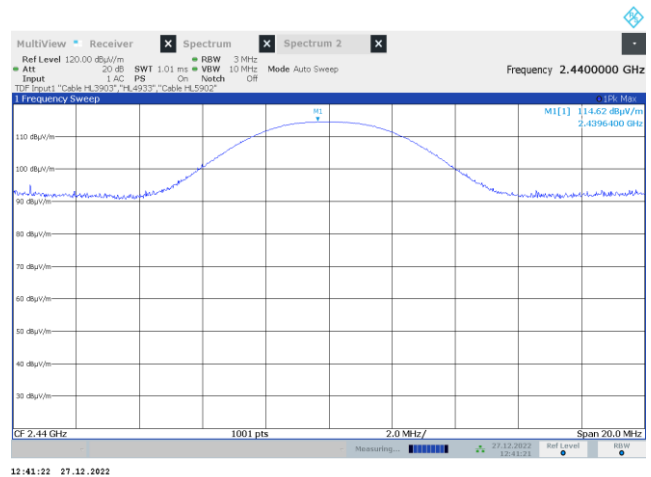

EUT Position - Vertical



HERMON LABORATORIES

Test specification: Section 15.247(b)3/ RSS-247 section 5.4(d), Peak output power			
Test procedure: ANSI C63.10 section 11.9.1.1			
Test mode: Compliance		Verdict: PASS	
Date(s): 08-Jul-22			
Temperature: 25 °C	Relative Humidity: 52 %	Air Pressure: 1012 hPa	Power: 110 VAC, 50 Hz
Remarks:			

Plot 7.2.3 Field strength of carrier at high frequency (worst case antenna polarization)

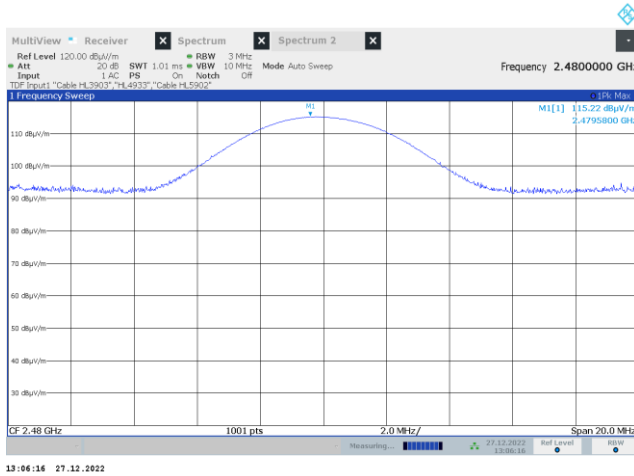

EUT Position – Horizontal

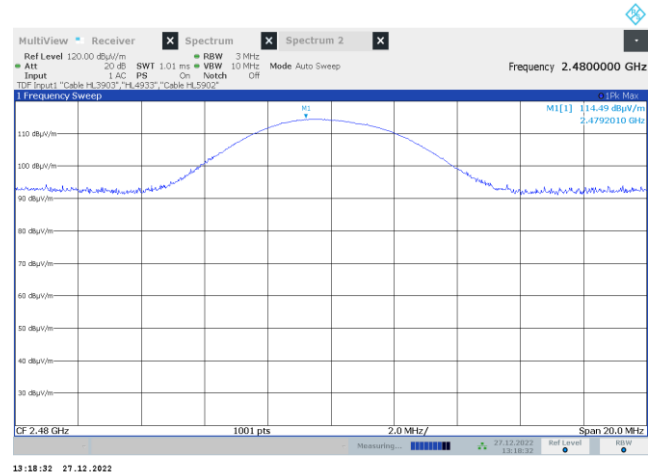

EUT Position - Vertical



Test specification: Section 15.247(d), RSS-247 section 5.5, Radiated spurious emissions			
Test procedure: ANSI C63.10, sections 6.5, 6.6			
Test mode: Compliance		Verdict: PASS	
Date(s): 01-Jul-22 - 08-Jul-22			
Temperature: 24 °C	Relative Humidity: 48 %	Air Pressure: 1012 hPa	Power: 110 VAC, 50 Hz
Remarks:			

7.3 Field strength of spurious emissions

7.3.1 General

This test was performed to measure field strength of spurious emissions from the EUT. Specification test limits are given in Table 7.3.1.

Table 7.3.1 Radiated spurious emissions limits

Frequency, MHz	Field strength at 3 m within restricted bands, dB(μV/m) ^{***}			Attenuation of field strength of spurious versus carrier outside restricted bands, dBc ^{***}
	Peak	Quasi Peak	Average	
0.009 – 0.090	148.5 – 128.5	NA	128.5 – 108.5 ^{**}	20.0
0.090 – 0.110	NA	108.5 – 106.8 ^{**}	NA	
0.110 – 0.490	126.8 – 113.8	NA	106.8 – 93.8 ^{**}	
0.490 – 1.705	NA	73.8 – 63.0 ^{**}	NA	
1.705 – 30.0*		69.5		
30 – 88		40.0		
88 – 216		43.5		
216 – 960		46.0		
960 - 1000		54.0		
1000 – 10 th harmonic	74.0	NA	54.0	

*- The limit for 3 m test distance was calculated using the inverse square distance extrapolation factor as follows:

$$\text{Lim}_{S_2} = \text{Lim}_{S_1} + 40 \log (S_1/S_2),$$
 where S₁ and S₂ – standard defined and test distance respectively in meters.

** - The limit decreases linearly with the logarithm of frequency.

*** - The field strength limits applied from the lowest radio frequency generated in the device, without going below 9 kHz up to the tenth harmonic of the highest fundamental frequency.

7.3.2 Test procedure for spurious emission field strength measurements in 9 kHz to 30 MHz band

7.3.2.1 The EUT was set up as shown in Figure 7.3.1, energized and the performance check was conducted.

7.3.2.2 The specified frequency range was investigated with antenna connected to spectrum analyzer/ EMI receiver. To find maximum radiation the turntable was rotated 360° and the measuring antenna was rotated around its vertical axis.

7.3.2.3 The worst test results (the lowest margins) were recorded and shown in the associated plots.

7.3.3 Test procedure for spurious emission field strength measurements above 30 MHz

7.3.3.1 The EUT was set up as shown in Figure 7.3.2, Figure 1.1.3, energized and the performance check was conducted.

7.3.3.2 The specified frequency range was investigated with antenna connected to spectrum analyzer/ EMI receiver. To find maximum radiation the turntable was rotated 360°, the measuring antenna height was changed from 1 to 4 m, its polarization was switched from vertical to horizontal.

7.3.3.3 The worst test results (the lowest margins) were recorded and shown in the associated plots.



Test specification: Section 15.247(d), RSS-247 section 5.5, Radiated spurious emissions			
Test procedure: ANSI C63.10, sections 6.5, 6.6			
Test mode: Compliance		Verdict: PASS	
Date(s): 01-Jul-22 - 08-Jul-22			
Temperature: 24 °C	Relative Humidity: 48 %	Air Pressure: 1012 hPa	Power: 110 VAC, 50 Hz
Remarks:			

Figure 7.3.1 Setup for spurious emission field strength measurements below 30 MHz

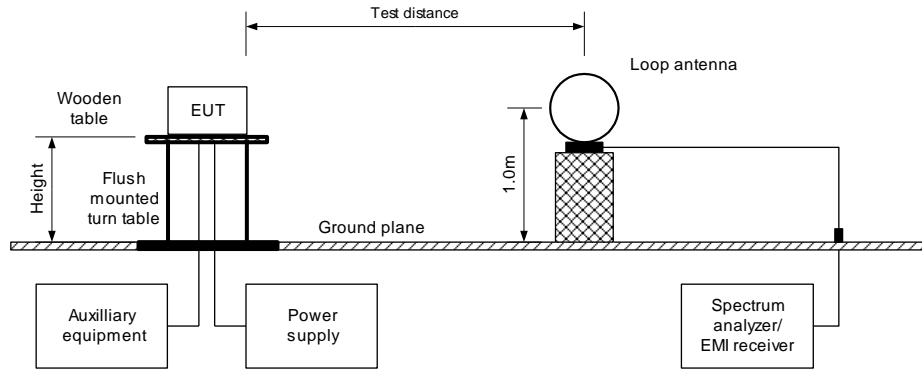
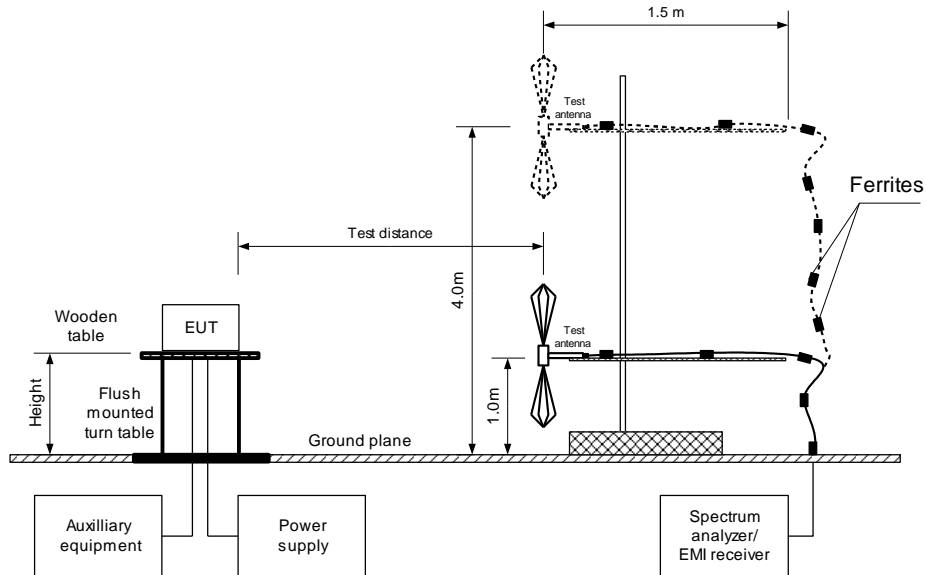

Figure 7.3.2 Setup for spurious emission field strength measurements from 30 to 1000 MHz





Test specification: Section 15.247(d), RSS-247 section 5.5, Radiated spurious emissions			
Test procedure: ANSI C63.10, sections 6.5, 6.6		Verdict: PASS	
Test mode: Compliance		Date(s): 01-Jul-22 - 08-Jul-22	
Temperature: 24 °C	Relative Humidity: 48 %	Air Pressure: 1012 hPa	Power: 110 VAC, 50 Hz
Remarks:			

Figure 7.3.3 Setup for spurious emission field strength measurements above 1000 MHz

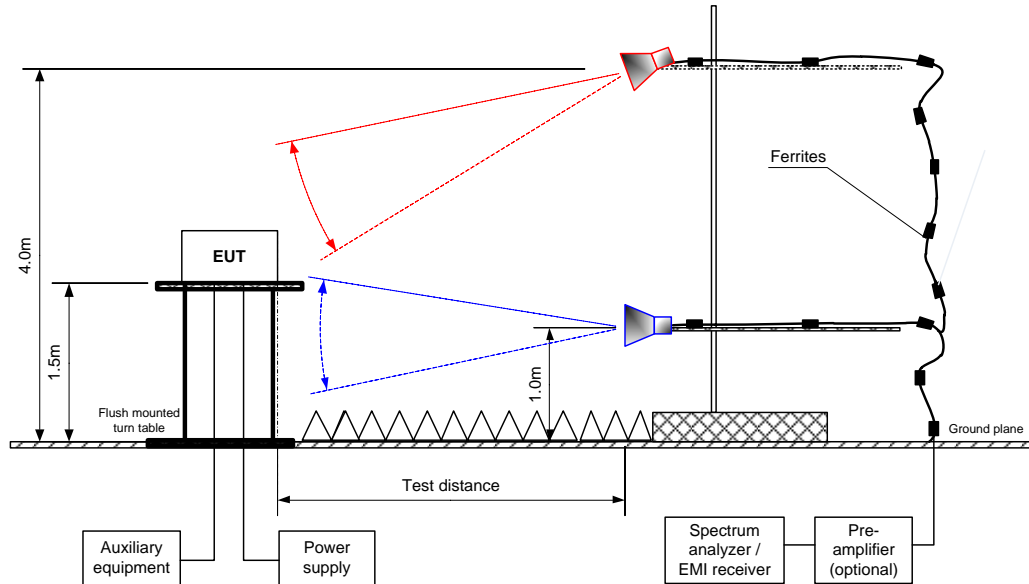



Test specification: Section 15.247(d), RSS-247 section 5.5, Radiated spurious emissions			
Test procedure: ANSI C63.10, sections 6.5, 6.6			
Test mode: Compliance		Verdict: PASS	
Date(s): 01-Jul-22 - 08-Jul-22			
Temperature: 24 °C	Relative Humidity: 48 %	Air Pressure: 1012 hPa	Power: 110 VAC, 50 Hz
Remarks:			

Table 7.3.2 Field strength of emissions outside restricted bands

ASSIGNED FREQUENCY: 2400-2483.5 MHz
 INVESTIGATED FREQUENCY RANGE: 0.009 -25000 MHz
 TEST DISTANCE: 3 m
 MODULATION: GFSK
 BIT RATE: 2 Mbps
 DETECTOR USED: Peak
 RESOLUTION BANDWIDTH: 100 kHz
 VIDEO BANDWIDTH: 300 kHz
 TEST ANTENNA TYPE: Active loop (9 kHz – 30 MHz)
 Biconilog (30 MHz – 1000 MHz)
 Double ridged guide (above 1000 MHz)
 FREQUENCY HOPPING: Disabled

Frequency, MHz	Field strength of spurious, dB(µV/m)	Antenna polarization	Antenna height, m	Azimuth, degrees*	Field strength of carrier, dB(µV/m)	Attenuation below carrier, dBc	Limit, dBc	Margin, dB**	Verdict
Low carrier frequency									
9608	51.63	Horizontal	1.5	34	114.07	62.44	20.0	42.44	Pass
Mid carrier frequency									
9760	58.08	Horizontal	1.5	-25	116.34	58.26	20.0	38.26	Pass
High carrier frequency									
9920	55.03	Horizontal	1.5	-18	115.70	60.67	20.0	40.67	Pass

*- EUT front panel refers to 0 degrees position of turntable.
 **- Margin = Attenuation below carrier – specification limit.

Table 7.3.3 Field strength of spurious emissions above 1 GHz within restricted bands

ASSIGNED FREQUENCY: 2400-2483.5 MHz
 INVESTIGATED FREQUENCY RANGE: 1000 -25000 MHz
 TEST DISTANCE: 3 m
 MODULATION: GFSK
 DETECTOR USED: Peak
 RESOLUTION BANDWIDTH: 1000 kHz
 TEST ANTENNA TYPE: Double ridged guide
 FREQUENCY HOPPING: Disabled

Frequency, MHz	Antenna			Peak field strength			Average field strength				Verdict
	Polarization	Height, m	Azimuth, degrees*	Measured, dB(µV/m)	Limit, dB(µV/m)	Margin, dB**	Measured Peak, dB(µV/m)	Calculated, dB(µV/m)	Limit, Avr, dB(µV/m)	Margin, dB***	
Low carrier frequency											
4804	Vertical	1.5	80	46.2	74	-27.80	46.20	NA	54	-7.80	Pass
Mid carrier frequency											
4880	Vertical	1.5	70	49.94	74	-24.06	49.94	NA	54	-4.06	Pass
7320	Vertical	1.5	55	49.92	74	-24.08	49.92	NA	54	-4.08	
High carrier frequency											
4960	Vertical	1.5	74	48.88	74	-25.12	48.88	NA	54	-5.12	Pass
7440	Vertical	1.5	-84	51.48	74	-22.52	51.48	NA	54	-2.52	

*- EUT front panel refers to 0 degrees position of turntable.
 **- Margin = Measured field strength - specification limit.
 ***- Margin = Calculated field strength - specification limit,
 where Calculated field strength = Measured field strength + average factor.



Test specification: Section 15.247(d), RSS-247 section 5.5, Radiated spurious emissions			
Test procedure: ANSI C63.10, sections 6.5, 6.6			
Test mode: Compliance		Verdict: PASS	
Date(s): 01-Jul-22 - 08-Jul-22			
Temperature: 24 °C	Relative Humidity: 48 %	Air Pressure: 1012 hPa	Power: 110 VAC, 50 Hz
Remarks:			

Table 7.3.4 Average factor calculation

Transmission pulse		Transmission burst		Transmission train duration, ms	Average factor, dB
Duration, ms	Period, ms	Duration, ms	Period, ms		
0.1	1600	NA	NA	NA	-60

Table 7.3.5 Field strength of spurious emissions below 1 GHz within restricted bands

ASSIGNED FREQUENCY: 2400-2483.5 MHz
 INVESTIGATED FREQUENCY RANGE: 0.009 – 1000 MHz
 TEST DISTANCE: 3 m
 MODULATION: GFSK
 BIT RATE: 2 Mbps
 RESOLUTION BANDWIDTH: 0.2 kHz (9 kHz – 150 kHz)
 9.0 kHz (150 kHz – 30 MHz)
 120 kHz (30 MHz – 1000 MHz)
 VIDEO BANDWIDTH: > Resolution bandwidth
 TEST ANTENNA TYPE: Active loop (9 kHz – 30 MHz)
 Log periodic (200 MHz – 1000 MHz)
 Biconilog (30 MHz – 1000 MHz)
 FREQUENCY HOPPING: Disabled

Frequency, MHz	Peak emission, dB(µV/m)	Quasi-peak			Antenna polarization	Antenna height, m	Turn-table position**, degrees	Verdict
		Measured emission, dB(µV/m)	Limit, dB(µV/m)	Margin, dB*				
Low carrier frequency								
125.3	31.8	26.8	43.5	-16.7	Vertical	1.0	116	Pass
Mid carrier frequency								
124.3	32.5	27.2	43.5	-24.3	Vertical	1.0	120	Pass
High carrier frequency								
124.0	32.7	27.1	43.5	-24.4	Vertical	1.0	129	Pass

*- Margin = Measured emission - specification limit.

** - EUT front panel refer to 0 degrees position of turntable.



Test specification: Section 15.247(d), RSS-247 section 5.5, Radiated spurious emissions			
Test procedure: ANSI C63.10, sections 6.5, 6.6			
Test mode: Compliance		Verdict: PASS	
Date(s): 01-Jul-22 - 08-Jul-22			
Temperature: 24 °C	Relative Humidity: 48 %	Air Pressure: 1012 hPa	Power: 110 VAC, 50 Hz
Remarks:			

Table 7.3.6 Restricted bands according to FCC section 15.205

MHz	MHz	MHz	MHz	MHz	GHz
0.09 - 0.11	8.37625 - 8.38675	73 - 74.6	399.9 - 410	2690 - 2900	10.6 - 12.7
0.495 - 0.505	8.41425 - 8.41475	74.8 - 75.2	608 - 614	3260 - 3267	13.25 - 13.4
2.1735 - 2.1905	12.29 - 12.293	108 - 121.94	960 - 1240	3332 - 3339	14.47 - 14.5
4.125 - 4.128	12.51975 - 12.52025	123 - 138	1300 - 1427	3345.8 - 3358	15.35 - 16.2
4.17725 - 4.17775	12.57675 - 12.57725	149.9 - 150.05	1435 - 1626.5	3600 - 4400	17.7 - 21.4
4.20725 - 4.20775	13.36 - 13.41	156.52475 - 156.52525	1645.5 - 1646.5	4500 - 5150	22.01 - 23.12
6.215 - 6.218	16.42 - 16.423	156.7 - 156.9	1660 - 1710	5350 - 5460	23.6 - 24
6.26775 - 6.26825	16.69475 - 16.69525	162.0125 - 167.17	1718.8 - 1722.2	7250 - 7750	31.2 - 31.8
6.31175 - 6.31225	16.80425 - 16.80475	167.72 - 173.2	2200 - 2300	8025 - 8500	36.43 - 36.5
8.291 - 8.294	25.5 - 25.67	240 - 285	2310 - 2390	9000 - 9200	Above 38.6
8.362 - 8.366	37.5 - 38.25	322 - 335.4	2483.5 - 2500	9300 - 9500	

Table 7.3.7 Restricted bands according to RSS-Gen

MHz	MHz	MHz	MHz	MHz	GHz
0.09 - 0.11	8.291 - 8.294	16.80425 - 16.80475	399.9 - 410	3260 - 3267	10.6 - 12.7
2.1735 - 2.1905	8.362 - 8.366	25.5 - 25.67	608 - 614	3332 - 3339	13.25 - 13.4
3.020 - 3.026	8.37625 - 8.38675	37.5 - 38.25	960 - 1427	3345.8 - 3358	14.47 - 14.5
4.125 - 4.128	8.41425 - 8.41475	73 - 74.6	1435 - 1626.5	3500 - 4400	15.35 - 16.2
4.17725 - 4.17775	12.29 - 12.293	74.8 - 75.2	1645.5 - 1646.5	4500 - 5150	17.7 - 21.4
4.20725 - 4.20775	12.51975 - 12.52025	108 - 138	1660 - 1710	5350 - 5460	22.01 - 23.12
5.677 - 5.683	12.57675 - 12.57725	156.52475 - 156.52525	1718.8 - 1722.2	7250 - 7750	23.6 - 24
6.215 - 6.218	13.36 - 13.41	156.7 - 156.9	2200 - 2300	8025 - 8500	31.2 - 31.8
6.26775 - 6.26825	16.42 - 16.423	240 - 285	2310 - 2390	9000 - 9200	36.43 - 36.5
6.31175 - 6.31225	16.69475 - 16.69525	322 - 335.4	2655 - 2900	9300 - 9500	Above 38.6

Reference numbers of test equipment used

HL 4933	HL 3818	HL 5288	HL 3903	HL 5902	HL 5112	HL 4529	HL 4372
HL 4360	HL446	HL4956					

Full description is given in Appendix A.



HERMON LABORATORIES

Test specification: Section 15.247(d), RSS-247 section 5.5, Radiated spurious emissions			
Test procedure: ANSI C63.10, sections 6.5, 6.6			
Test mode: Compliance		Verdict: PASS	
Date(s): 01-Jul-22 - 08-Jul-22			
Temperature: 24 °C	Relative Humidity: 48 %	Air Pressure: 1012 hPa	Power: 110 VAC, 50 Hz
Remarks:			

Plot 7.3.1 Radiated emission measurements at the low carrier frequency

TEST SITE: Semi anechoic chamber
TEST DISTANCE: 3 m
ANTENNA POLARIZATION: Vertical & Horizontal

Agilent 14:51:30 Jul 1, 2022

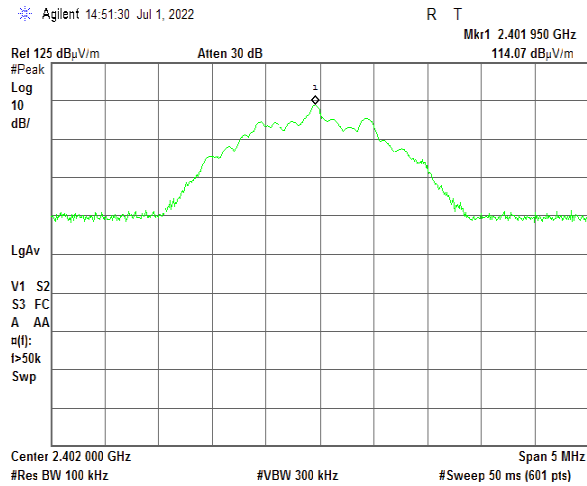

Plot 7.3.2 Radiated emission measurements at the mid carrier frequency

TEST SITE: Semi anechoic chamber
TEST DISTANCE: 3 m
ANTENNA POLARIZATION: Vertical & Horizontal

Agilent 15:00:29 Jul 1, 2022

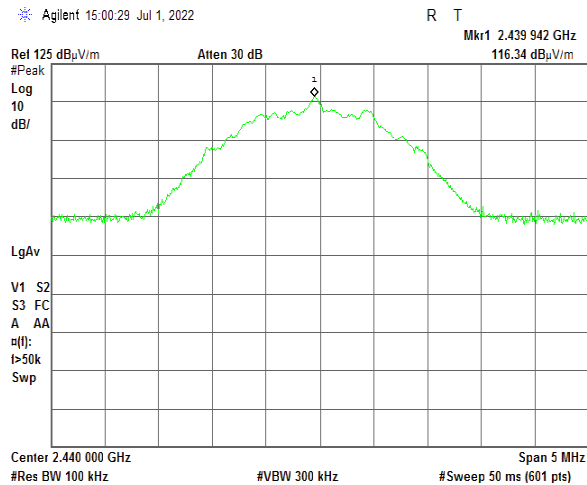



HERMON LABORATORIES

Test specification: Section 15.247(d), RSS-247 section 5.5, Radiated spurious emissions			
Test procedure: ANSI C63.10, sections 6.5, 6.6			
Test mode: Compliance		Verdict: PASS	
Date(s): 01-Jul-22 - 08-Jul-22			
Temperature: 24 °C	Relative Humidity: 48 %	Air Pressure: 1012 hPa	Power: 110 VAC, 50 Hz
Remarks:			

Plot 7.3.3 Radiated emission measurements at the high carrier frequency

TEST SITE: Semi anechoic chamber
TEST DISTANCE: 3 m
ANTENNA POLARIZATION: Vertical & Horizontal

Agilent 15:03:39 Jul 1, 2022

R T

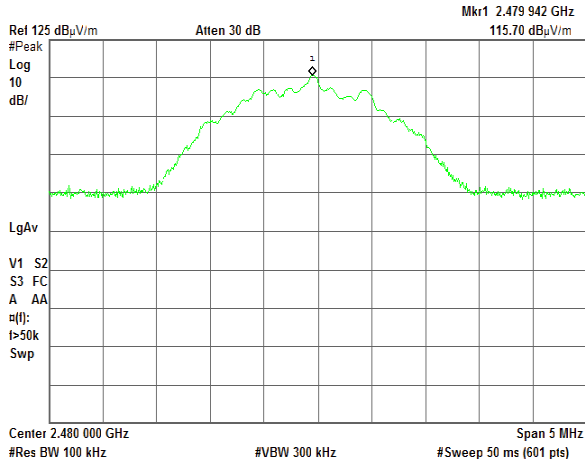



Test specification: Section 15.247(d), RSS-247 section 5.5, Radiated spurious emissions			
Test procedure: ANSI C63.10, sections 6.5, 6.6			
Test mode: Compliance		Verdict: PASS	
Date(s): 01-Jul-22 - 08-Jul-22			
Temperature: 24 °C	Relative Humidity: 48 %	Air Pressure: 1012 hPa	Power: 110 VAC, 50 Hz
Remarks:			

Plot 7.3.4 Radiated emission measurements from 9k to 30M Hz at the low carrier frequency

TEST SITE: Semi anechoic chamber
 TEST DISTANCE: 3 m
 ANTENNA POLARIZATION: Vertical

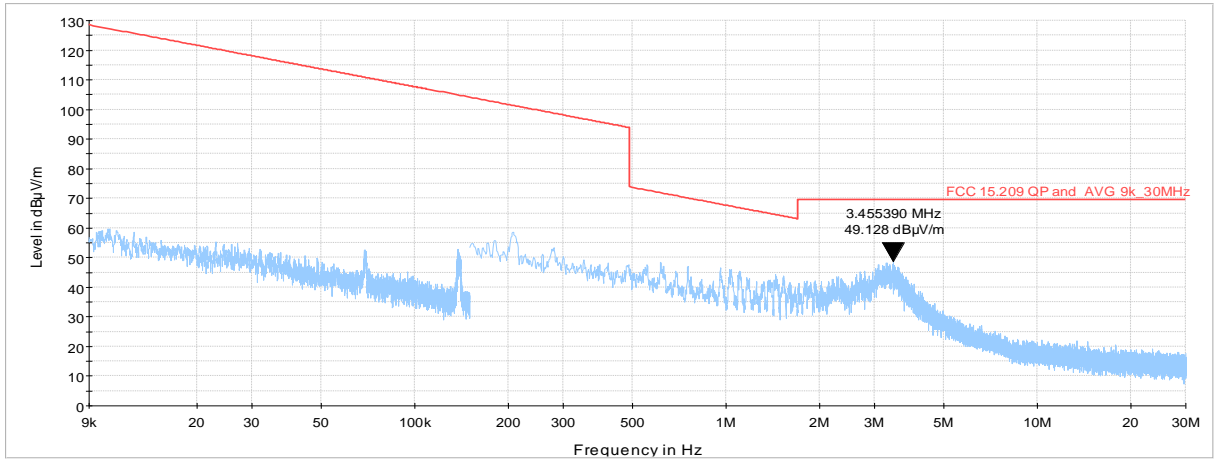

Plot 7.3.5 Radiated emission measurements from 9k to 30M Hz at the low carrier frequency

TEST SITE: Semi anechoic chamber
 TEST DISTANCE: 3 m
 ANTENNA POLARIZATION: Horizontal

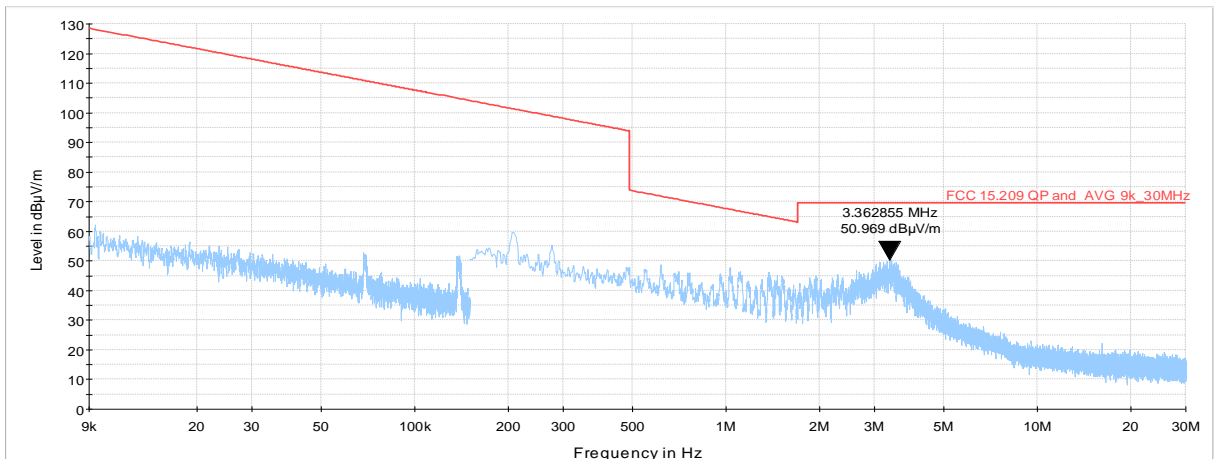



HERMON LABORATORIES

Test specification: Section 15.247(d), RSS-247 section 5.5, Radiated spurious emissions			
Test procedure: ANSI C63.10, sections 6.5, 6.6			
Test mode: Compliance		Verdict: PASS	
Date(s): 01-Jul-22 - 08-Jul-22			
Temperature: 24 °C	Relative Humidity: 48 %	Air Pressure: 1012 hPa	Power: 110 VAC, 50 Hz
Remarks:			

Plot 7.3.6 Radiated emission measurements from 9k to 30M at the mid carrier frequency

TEST SITE: Semi anechoic chamber
TEST DISTANCE: 3 m
ANTENNA POLARIZATION: Vertical

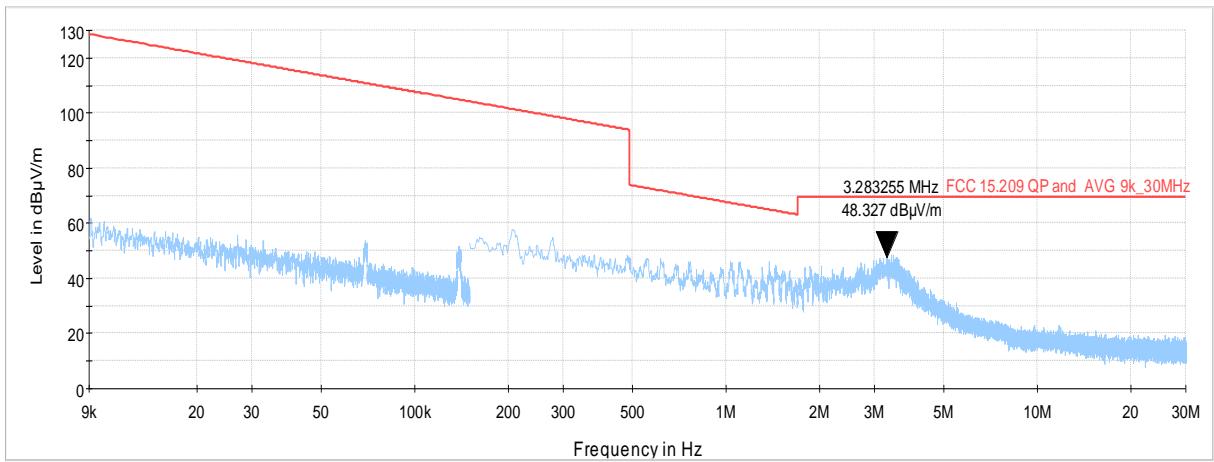

Plot 7.3.7 Radiated emission measurements from 9k to 30M at the mid carrier frequency

TEST SITE: Semi anechoic chamber
TEST DISTANCE: 3 m
ANTENNA POLARIZATION: Horizontal

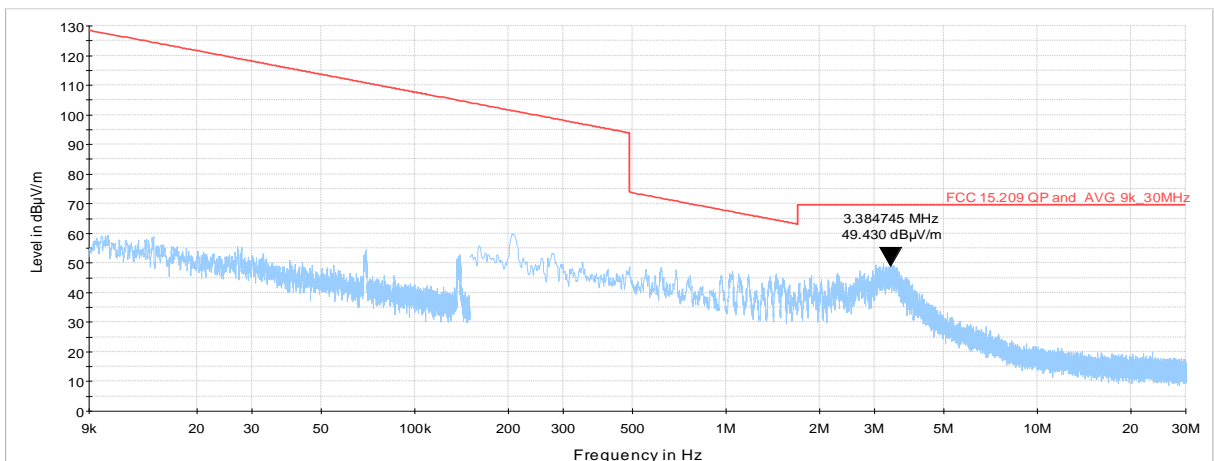



Test specification: Section 15.247(d), RSS-247 section 5.5, Radiated spurious emissions			
Test procedure: ANSI C63.10, sections 6.5, 6.6			
Test mode: Compliance		Verdict: PASS	
Date(s): 01-Jul-22 - 08-Jul-22			
Temperature: 24 °C	Relative Humidity: 48 %	Air Pressure: 1012 hPa	Power: 110 VAC, 50 Hz
Remarks:			

Plot 7.3.8 Radiated emission measurements from 9k to 30M at the high carrier frequency

TEST SITE: Semi anechoic chamber
 TEST DISTANCE: 3 m
 ANTENNA POLARIZATION: Vertical

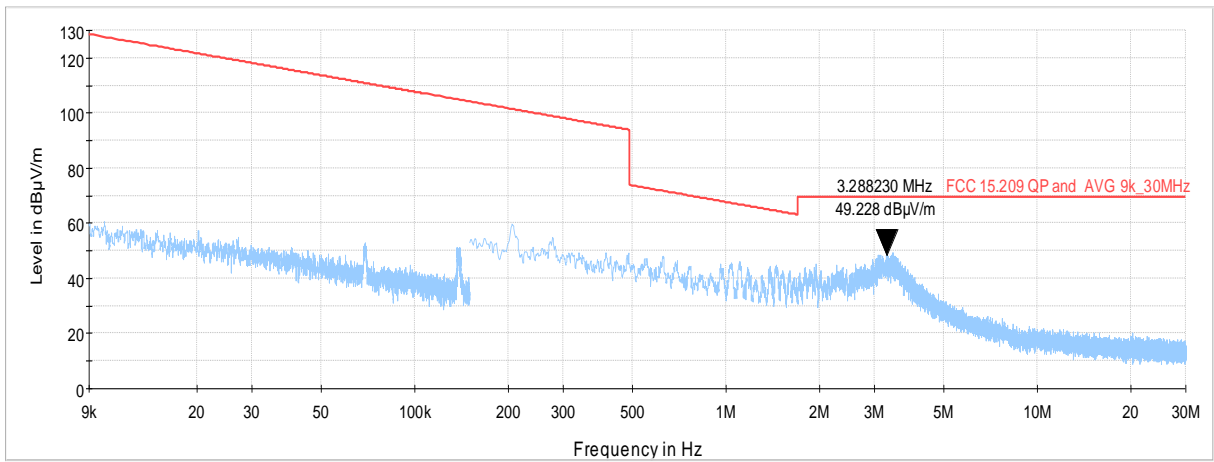

Plot 7.3.9 Radiated emission measurements from 9k to 30M at the high carrier frequency

TEST SITE: Semi anechoic chamber
 TEST DISTANCE: 3 m
 ANTENNA POLARIZATION: Horizontal

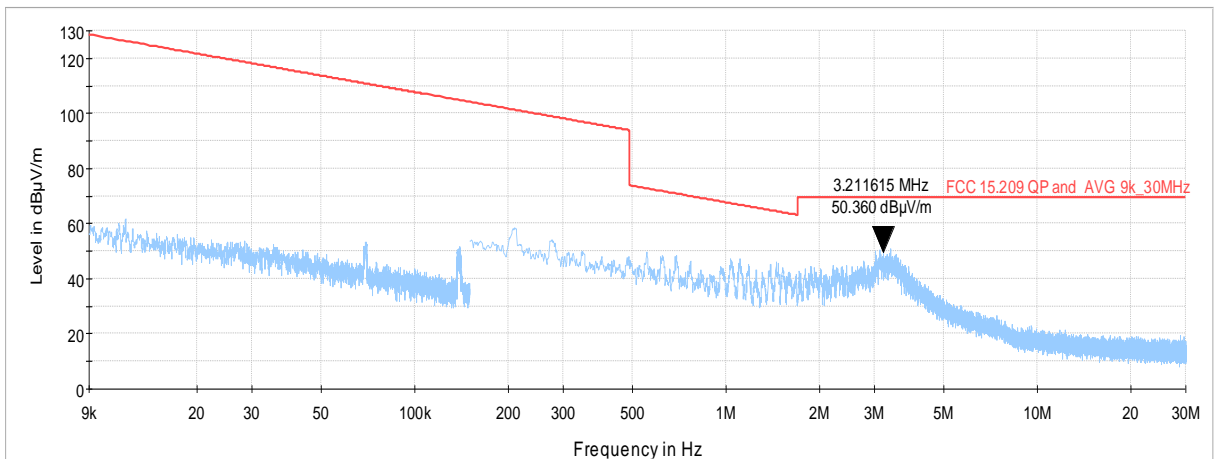



Test specification: Section 15.247(d), RSS-247 section 5.5, Radiated spurious emissions			
Test procedure: ANSI C63.10, sections 6.5, 6.6			
Test mode: Compliance		Verdict: PASS	
Date(s): 01-Jul-22 - 08-Jul-22			
Temperature: 24 °C	Relative Humidity: 48 %	Air Pressure: 1012 hPa	Power: 110 VAC, 50 Hz
Remarks:			

Plot 7.3.10 Radiated emission measurements from 30 to 1000 MHz at the low carrier frequency

TEST SITE: Semi anechoic chamber
 TEST DISTANCE: 3 m
 ANTENNA POLARIZATION: Vertical and Horizontal

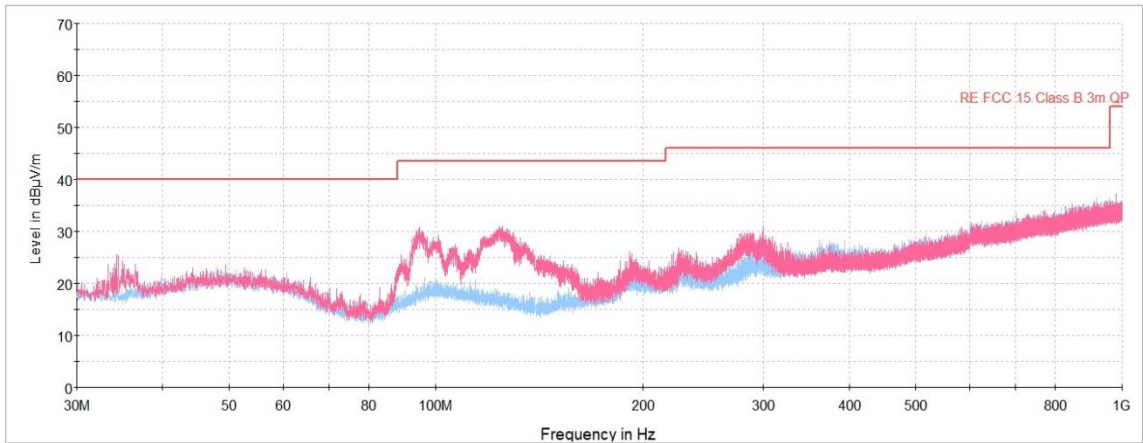

Plot 7.3.11 Radiated emission measurements from 30 to 1000 MHz at the mid carrier frequency

TEST SITE: Semi anechoic chamber
 TEST DISTANCE: 3 m
 ANTENNA POLARIZATION: Vertical and Horizontal

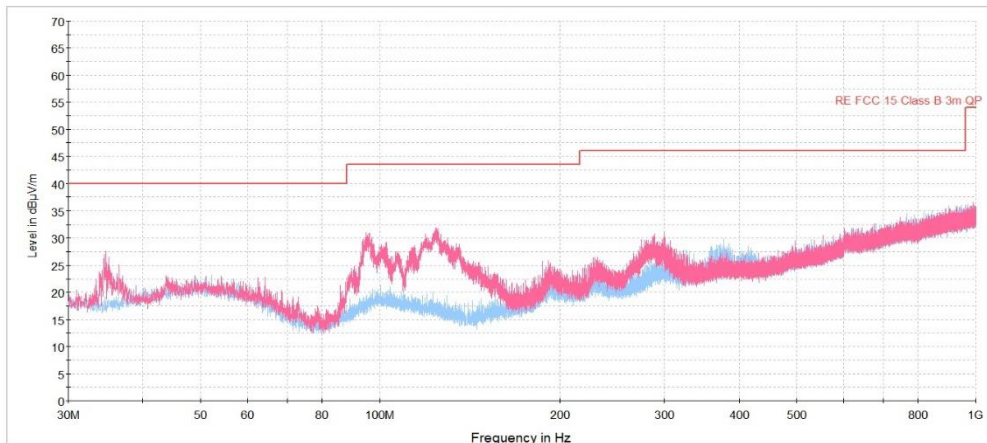



Test specification: Section 15.247(d), RSS-247 section 5.5, Radiated spurious emissions			
Test procedure: ANSI C63.10, sections 6.5, 6.6			
Test mode: Compliance		Verdict: PASS	
Date(s): 01-Jul-22 - 08-Jul-22			
Temperature: 24 °C	Relative Humidity: 48 %	Air Pressure: 1012 hPa	Power: 110 VAC, 50 Hz
Remarks:			

Plot 7.3.12 Radiated emission measurements from 30 to 1000 MHz at the high carrier frequency

TEST SITE: Semi anechoic chamber
 TEST DISTANCE: 3 m
 ANTENNA POLARIZATION: Vertical and Horizontal

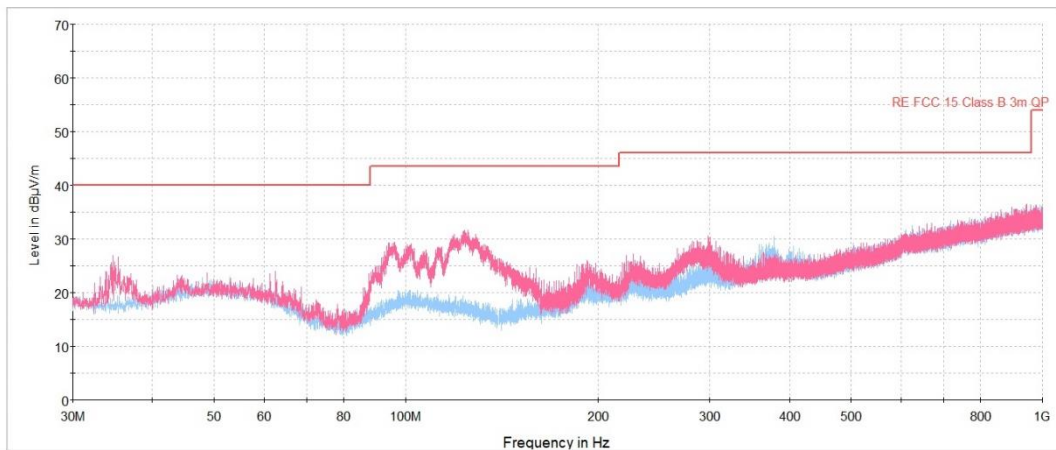

Plot 7.3.13 Radiated emission measurements from 1000 to 2390 MHz at the low carrier frequency

TEST SITE: Semi anechoic chamber
 TEST DISTANCE: 3 m
 ANTENNA POLARIZATION: Vertical and Horizontal

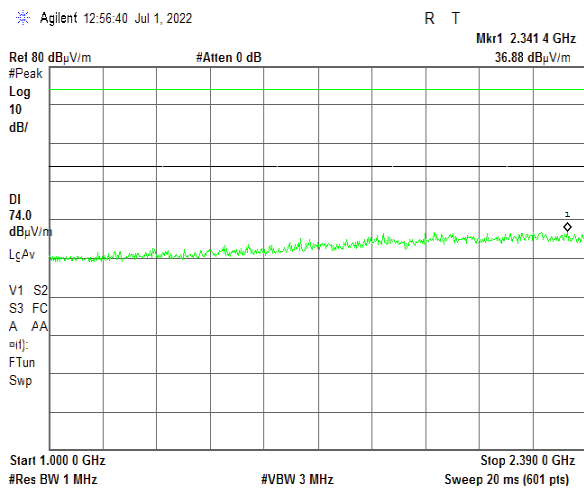



Test specification: Section 15.247(d), RSS-247 section 5.5, Radiated spurious emissions			
Test procedure: ANSI C63.10, sections 6.5, 6.6			
Test mode: Compliance		Verdict: PASS	
Date(s): 01-Jul-22 - 08-Jul-22			
Temperature: 24 °C	Relative Humidity: 48 %	Air Pressure: 1012 hPa	Power: 110 VAC, 50 Hz
Remarks:			

Plot 7.3.14 Radiated emission measurements from 1000 to 2390 MHz at the mid carrier frequency

TEST SITE: Semi anechoic chamber
TEST DISTANCE: 3 m
ANTENNA POLARIZATION: Vertical and Horizontal

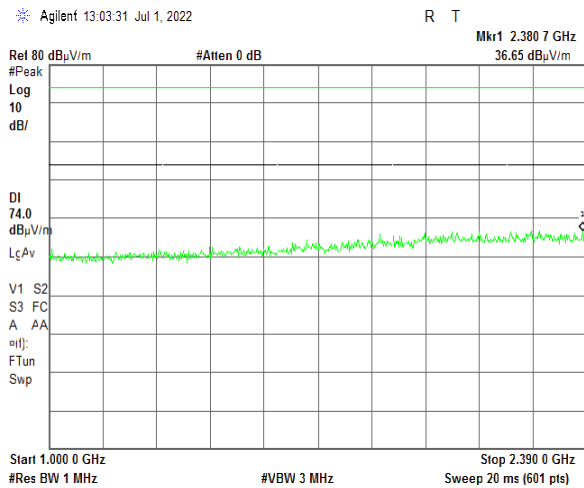

Plot 7.3.15 Radiated emission measurements from 1000 to 2390 MHz at the high carrier frequency

TEST SITE: Semi anechoic chamber
TEST DISTANCE: 3 m
ANTENNA POLARIZATION: Vertical and Horizontal

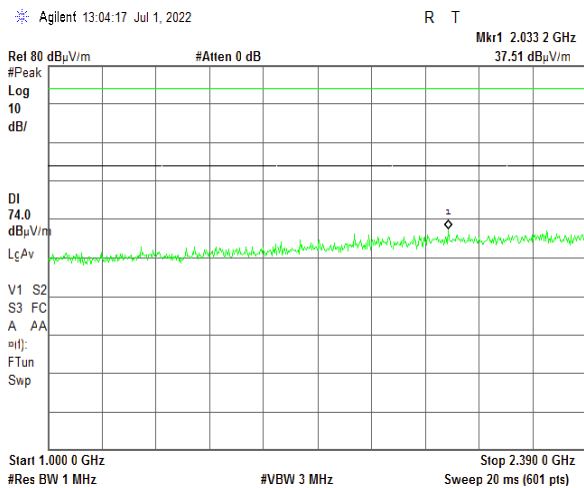



HERMON LABORATORIES

Test specification: Section 15.247(d), RSS-247 section 5.5, Radiated spurious emissions			
Test procedure: ANSI C63.10, sections 6.5, 6.6			
Test mode: Compliance		Verdict: PASS	
Date(s): 01-Jul-22 - 08-Jul-22			
Temperature: 24 °C	Relative Humidity: 48 %	Air Pressure: 1012 hPa	Power: 110 VAC, 50 Hz
Remarks:			

Plot 7.3.16 Radiated emission measurements from 2500 to 4250 MHz at the low carrier frequency

TEST SITE: Semi anechoic chamber
TEST DISTANCE: 3 m
ANTENNA POLARIZATION: Vertical and Horizontal

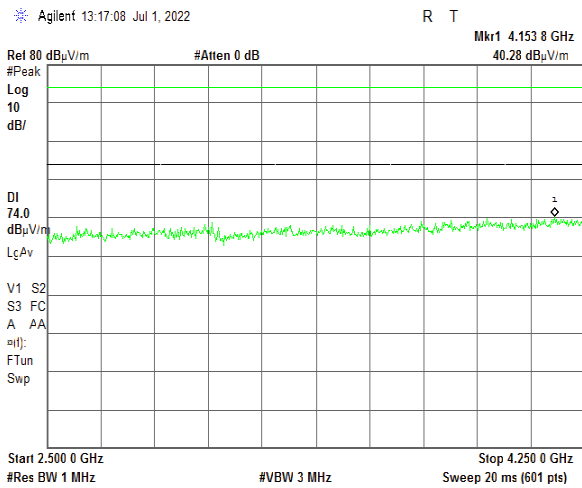

Plot 7.3.17 Radiated emission measurements from 2500 to 4250 MHz at the mid carrier frequency

TEST SITE: Semi anechoic chamber
TEST DISTANCE: 3 m
ANTENNA POLARIZATION: Vertical and Horizontal

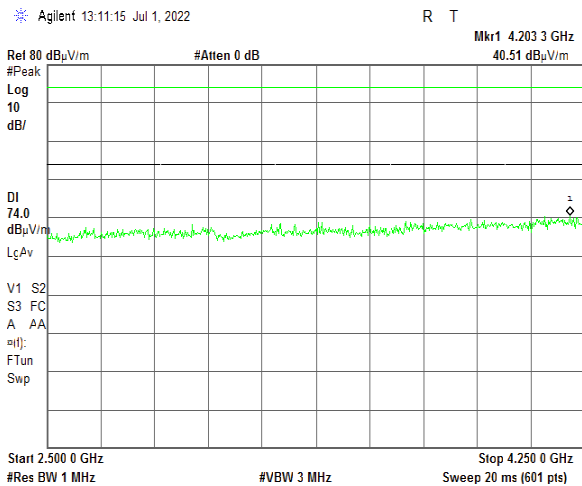



Test specification: Section 15.247(d), RSS-247 section 5.5, Radiated spurious emissions			
Test procedure: ANSI C63.10, sections 6.5, 6.6			
Test mode: Compliance		Verdict: PASS	
Date(s): 01-Jul-22 - 08-Jul-22			
Temperature: 24 °C	Relative Humidity: 48 %	Air Pressure: 1012 hPa	Power: 110 VAC, 50 Hz
Remarks:			

Plot 7.3.18 Radiated emission measurements from 2500 to 4250 MHz at the high carrier frequency

TEST SITE: Semi anechoic chamber
TEST DISTANCE: 3 m
ANTENNA POLARIZATION: Vertical and Horizontal

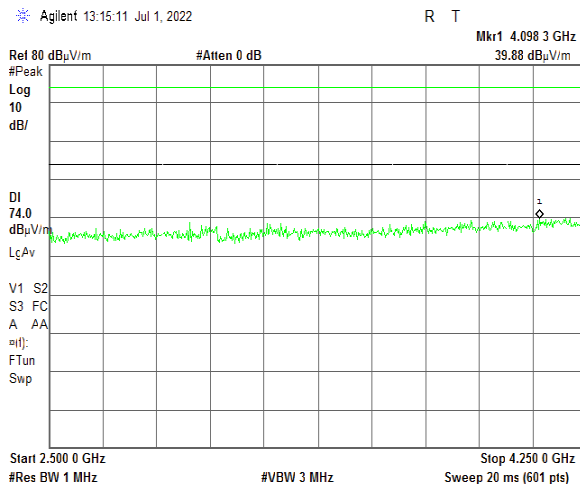

Plot 7.3.19 Radiated emission measurements from 4250 to 10000 MHz at the low carrier frequency

TEST SITE: Semi anechoic chamber
TEST DISTANCE: 3 m
ANTENNA POLARIZATION: Vertical and Horizontal

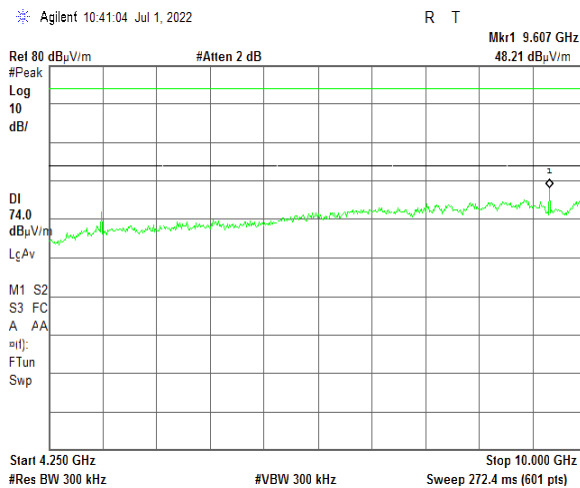



Test specification: Section 15.247(d), RSS-247 section 5.5, Radiated spurious emissions			
Test procedure: ANSI C63.10, sections 6.5, 6.6			
Test mode: Compliance		Verdict: PASS	
Date(s): 01-Jul-22 - 08-Jul-22			
Temperature: 24 °C	Relative Humidity: 48 %	Air Pressure: 1012 hPa	Power: 110 VAC, 50 Hz
Remarks:			

Plot 7.3.20 Radiated emission measurements from 4250 to 10000 MHz at the mid carrier frequency

TEST SITE: Semi anechoic chamber
 TEST DISTANCE: 3 m
 ANTENNA POLARIZATION: Vertical and Horizontal

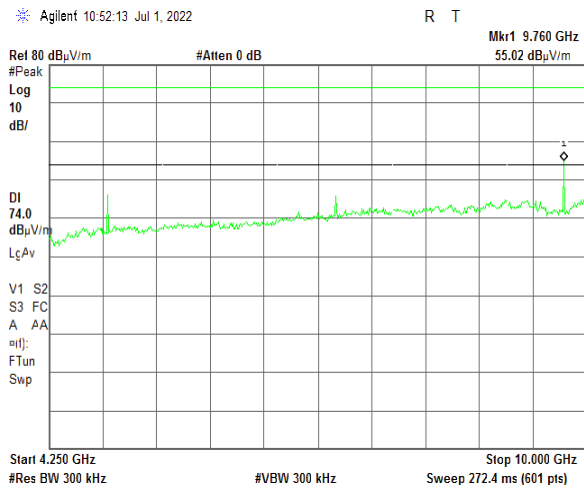

Plot 7.3.21 Radiated emission measurements from 4250 to 10000 MHz at the high carrier frequency

TEST SITE: Semi anechoic chamber
 TEST DISTANCE: 3 m
 ANTENNA POLARIZATION: Vertical and Horizontal

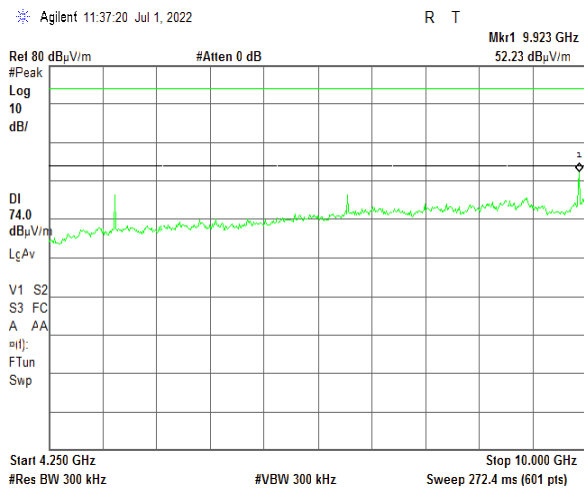



Test specification: Section 15.247(d), RSS-247 section 5.5, Radiated spurious emissions			
Test procedure: ANSI C63.10, sections 6.5, 6.6			
Test mode: Compliance		Verdict: PASS	
Date(s): 01-Jul-22 - 08-Jul-22			
Temperature: 24 °C	Relative Humidity: 48 %	Air Pressure: 1012 hPa	Power: 110 VAC, 50 Hz
Remarks:			

Plot 7.3.22 Radiated emission measurements from 10000 to 18000 MHz at the low carrier frequency

TEST SITE: Semi anechoic chamber
TEST DISTANCE: 3 m
ANTENNA POLARIZATION: Vertical and Horizontal

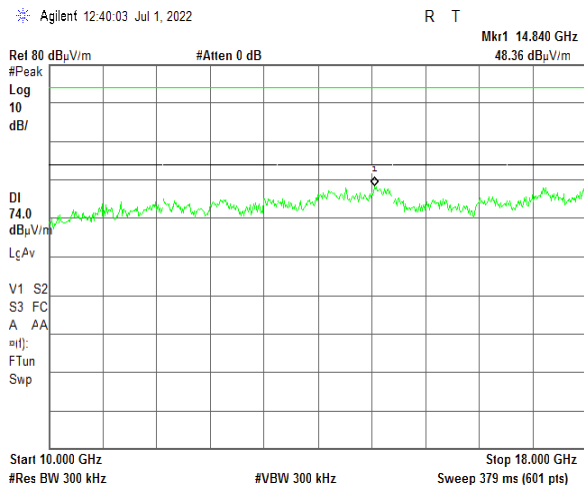

Plot 7.3.23 Radiated emission measurements from 10000 to 18000 MHz at the mid carrier frequency

TEST SITE: Semi anechoic chamber
TEST DISTANCE: 3 m
ANTENNA POLARIZATION: Vertical and Horizontal

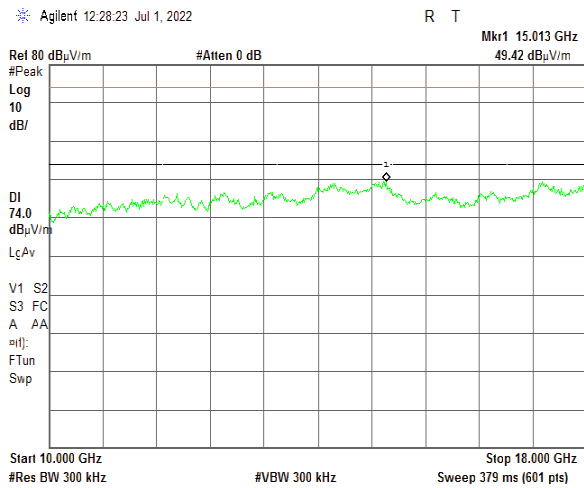



HERMON LABORATORIES

Test specification: Section 15.247(d), RSS-247 section 5.5, Radiated spurious emissions			
Test procedure: ANSI C63.10, sections 6.5, 6.6			
Test mode: Compliance		Verdict: PASS	
Date(s): 01-Jul-22 - 08-Jul-22			
Temperature: 24 °C	Relative Humidity: 48 %	Air Pressure: 1012 hPa	Power: 110 VAC, 50 Hz
Remarks:			

Plot 7.3.24 Radiated emission measurements from 10000 to 18000 MHz at the high carrier frequency

TEST SITE: Semi anechoic chamber
TEST DISTANCE: 3 m
ANTENNA POLARIZATION: Vertical and Horizontal

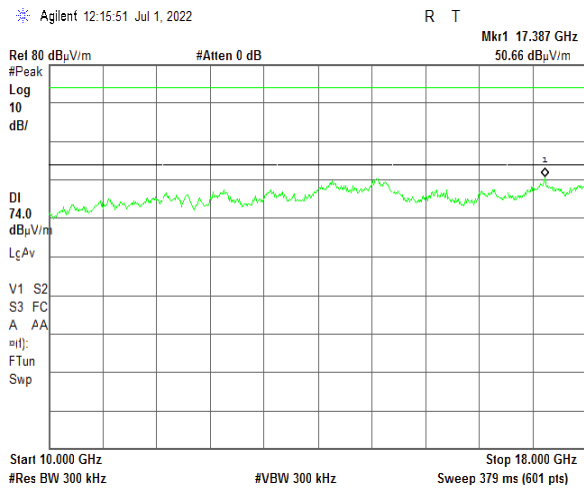

Plot 7.3.25 Radiated emission measurements from 18000 to 25000 MHz at the low carrier frequency

TEST SITE: Semi anechoic chamber
TEST DISTANCE: 3 m
ANTENNA POLARIZATION: Vertical and Horizontal

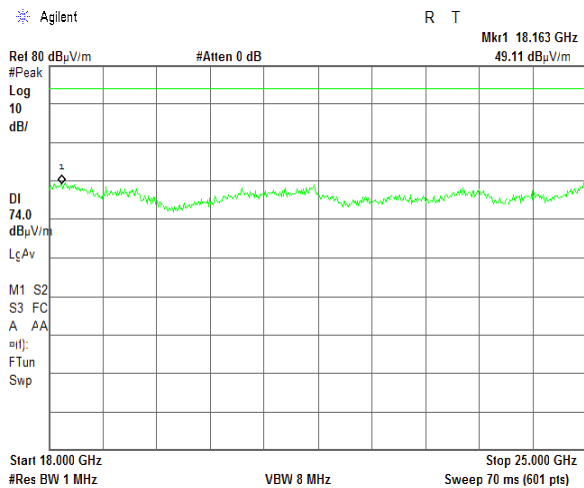



Test specification: Section 15.247(d), RSS-247 section 5.5, Radiated spurious emissions			
Test procedure: ANSI C63.10, sections 6.5, 6.6			
Test mode: Compliance		Verdict: PASS	
Date(s): 01-Jul-22 - 08-Jul-22			
Temperature: 24 °C	Relative Humidity: 48 %	Air Pressure: 1012 hPa	Power: 110 VAC, 50 Hz
Remarks:			

Plot 7.3.26 Radiated emission measurements from 18000 to 25000 MHz at the mid carrier frequency

TEST SITE: Semi anechoic chamber
TEST DISTANCE: 3 m
ANTENNA POLARIZATION: Vertical and Horizontal

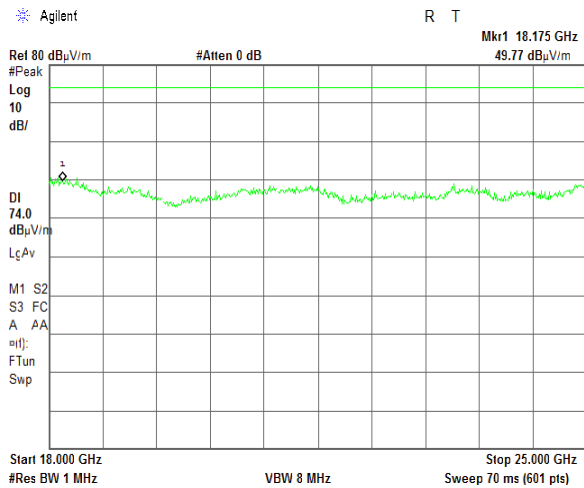

Plot 7.3.27 Radiated emission measurements from 18000 to 25000 MHz at the high carrier frequency

TEST SITE: Semi anechoic chamber
TEST DISTANCE: 3 m
ANTENNA POLARIZATION: Vertical and Horizontal

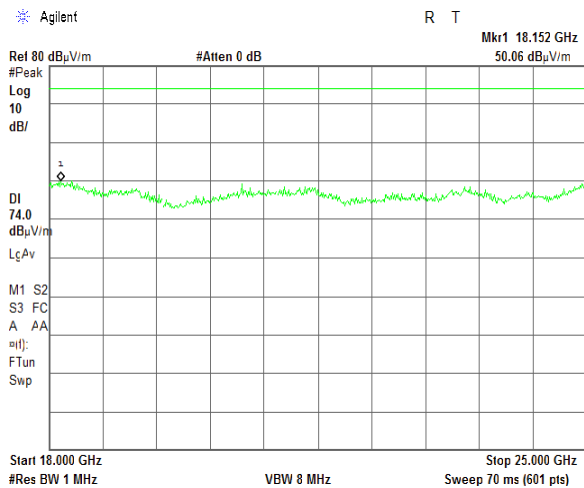



Test specification: Section 15.247(d), RSS-247 section 5.5, Radiated spurious emissions			
Test procedure: ANSI C63.10, sections 6.5, 6.6			
Test mode: Compliance		Verdict: PASS	
Date(s): 01-Jul-22 - 08-Jul-22			
Temperature: 24 °C	Relative Humidity: 48 %	Air Pressure: 1012 hPa	Power: 110 VAC, 50 Hz
Remarks:			

Plot 7.3.28 Radiated emission measurements at the second harmonic of low carrier frequency

TEST SITE: Semi anechoic chamber
TEST DISTANCE: 3 m

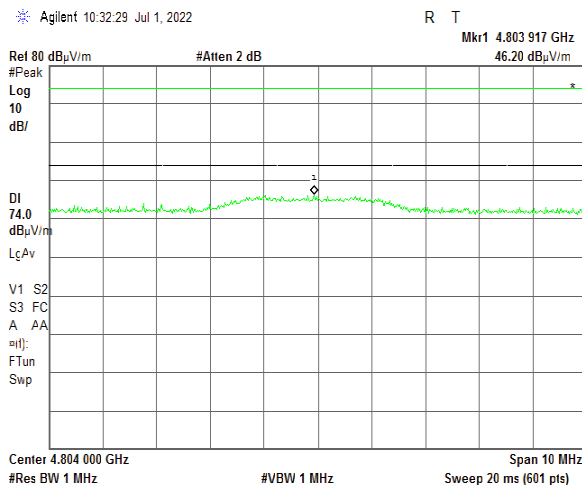

Plot 7.3.29 Radiated emission measurements at the second harmonic of mid carrier frequency

TEST SITE: Semi anechoic chamber
TEST DISTANCE: 3 m

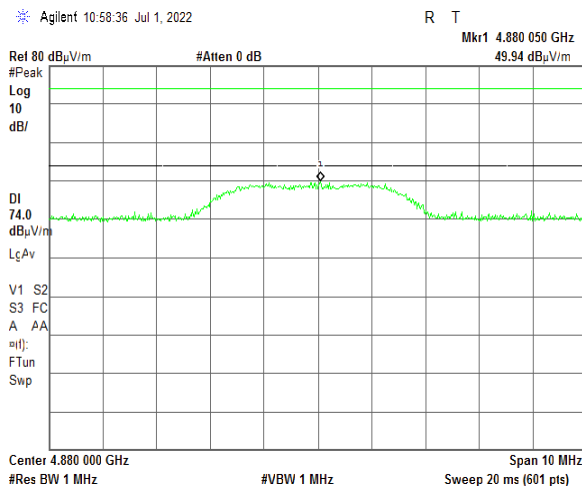



Test specification: Section 15.247(d), RSS-247 section 5.5, Radiated spurious emissions			
Test procedure: ANSI C63.10, sections 6.5, 6.6			
Test mode: Compliance		Verdict: PASS	
Date(s): 01-Jul-22 - 08-Jul-22			
Temperature: 24 °C	Relative Humidity: 48 %	Air Pressure: 1012 hPa	Power: 110 VAC, 50 Hz
Remarks:			

Plot 7.3.30 Radiated emission measurements at the second harmonic of high carrier frequency

TEST SITE: Semi anechoic chamber
TEST DISTANCE: 3 m

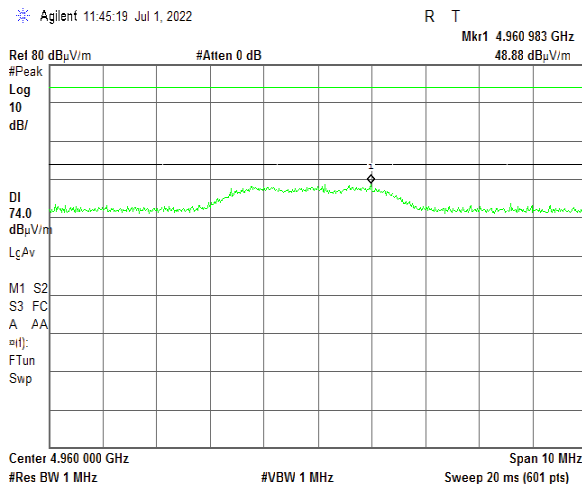

Plot 7.3.31 Radiated emission measurements at the third harmonic of mid carrier frequency

TEST SITE: Semi anechoic chamber
TEST DISTANCE: 3 m

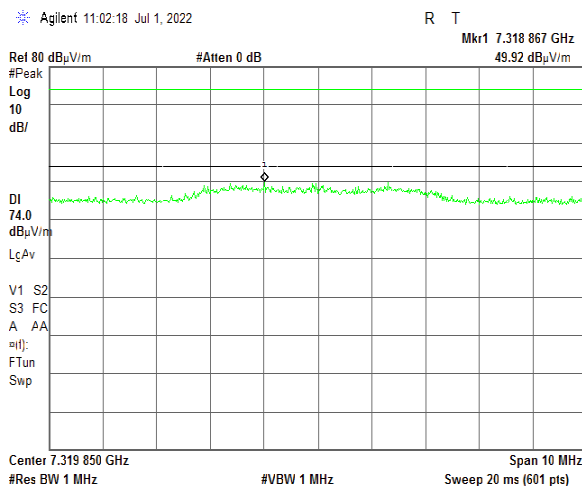



HERMON LABORATORIES

Test specification: Section 15.247(d), RSS-247 section 5.5, Radiated spurious emissions			
Test procedure: ANSI C63.10, sections 6.5, 6.6			
Test mode: Compliance		Verdict: PASS	
Date(s): 01-Jul-22 - 08-Jul-22			
Temperature: 24 °C	Relative Humidity: 48 %	Air Pressure: 1012 hPa	Power: 110 VAC, 50 Hz
Remarks:			

Plot 7.3.32 Radiated emission measurements at the third harmonic of high carrier frequency

TEST SITE: Semi anechoic chamber
TEST DISTANCE: 3 m

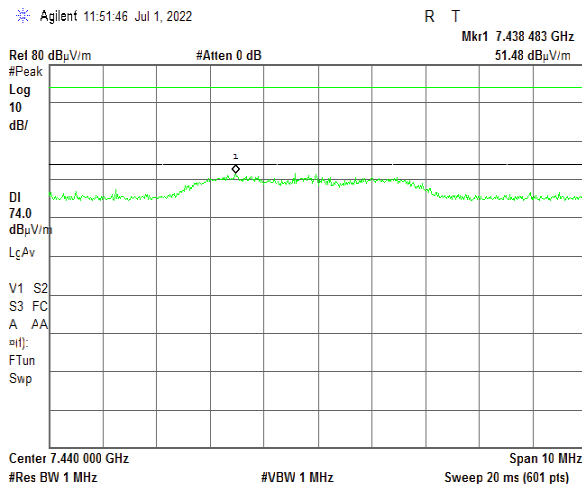

Plot 7.3.33 Radiated emission measurements at the fourth harmonic of low carrier frequency

TEST SITE: Semi anechoic chamber
TEST DISTANCE: 3 m

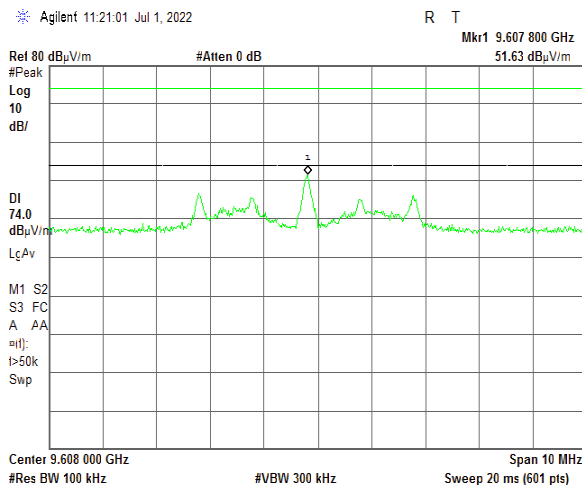



HERMON LABORATORIES

Test specification: Section 15.247(d), RSS-247 section 5.5, Radiated spurious emissions			
Test procedure: ANSI C63.10, sections 6.5, 6.6			
Test mode: Compliance		Verdict: PASS	
Date(s): 01-Jul-22 - 08-Jul-22			
Temperature: 24 °C	Relative Humidity: 48 %	Air Pressure: 1012 hPa	Power: 110 VAC, 50 Hz
Remarks:			

Plot 7.3.34 Radiated emission measurements at the fourth harmonic of mid carrier frequency

TEST SITE: Semi anechoic chamber
TEST DISTANCE: 3 m

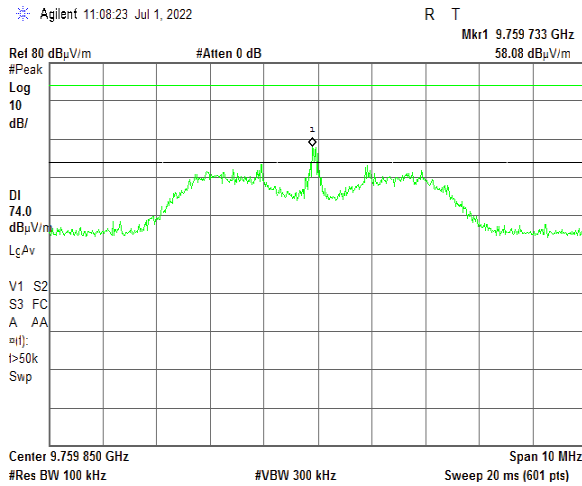

Plot 7.3.35 Radiated emission measurements at the fourth harmonic of high carrier frequency

TEST SITE: Semi anechoic chamber
TEST DISTANCE: 3 m

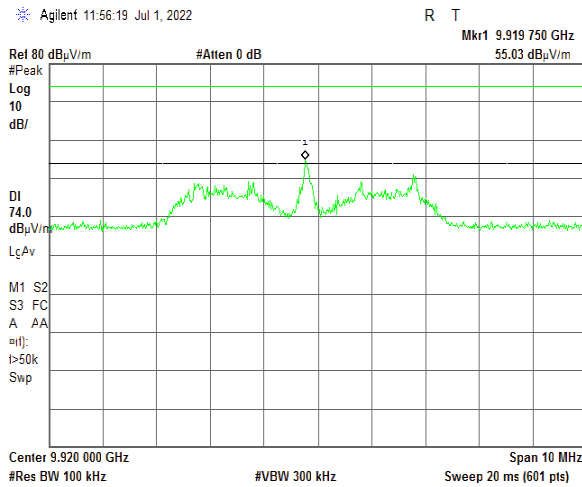



HERMON LABORATORIES

Test specification: Section 15.247(d), RSS-247 section 5.5, Radiated spurious emissions			
Test procedure: ANSI C63.10, sections 6.5, 6.6			
Test mode: Compliance		Verdict: PASS	
Date(s): 01-Jul-22 - 08-Jul-22			
Temperature: 24 °C	Relative Humidity: 48 %	Air Pressure: 1012 hPa	Power: 110 VAC, 50 Hz
Remarks:			

Plot 7.3.36 Single transmission duration

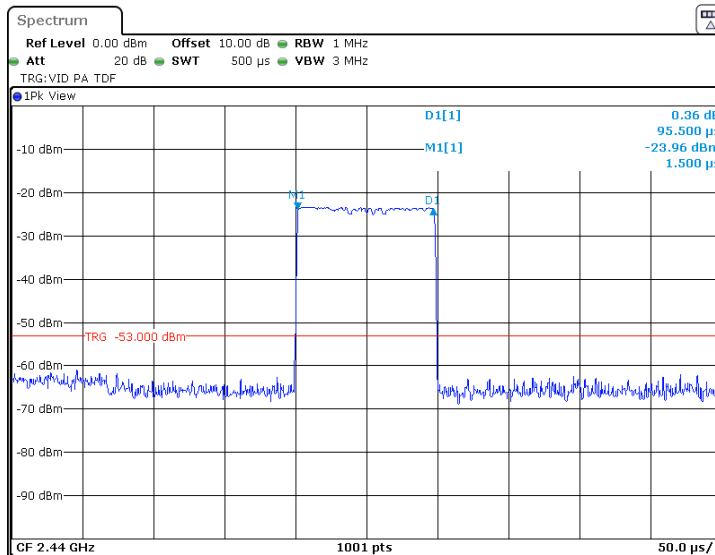

Plot 7.3.37 Single transmission period

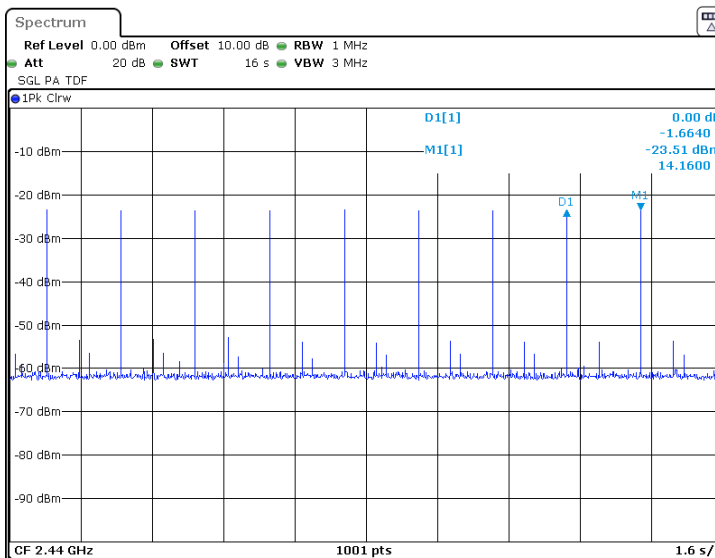



Test specification: Section 15.247(d) / RSS-247 section 5.5, Band edge emissions			
Test procedure: ANSI C63.10 section 11.12.1			
Test mode: Compliance		Verdict: PASS	
Date(s): 08-Jul-22			
Temperature: 25 °C	Relative Humidity: 58 %	Air Pressure: 1012 hPa	Power: 110 VAC, 50 Hz
Remarks:			

7.4 Band edge radiated emissions

7.4.1 General

This test was performed to measure emissions, radiated from the EUT at the assigned frequency band edges. Specification test limits are given in Table 7.4.1.

Table 7.4.1 Band edge emission limits

Assigned frequency, MHz	Attenuation below carrier*, dBc	Field strength at 3 m within restricted bands, dB(µV/m)	
		Peak	Average
902.0 – 928.0	20.0	74.0	54.0
2400.0 – 2483.5			
5725.0 – 5850.0			

* - Band edge emission limit is provided in terms of attenuation below the peak of modulated carrier measured with the same resolution bandwidth.

7.4.2 Test procedure

- 7.4.2.1 The EUT was set up as shown in Figure 7.9.1, energized normally modulated at the maximum data rate with its hopping function disabled and its proper operation was checked.
- 7.4.2.2 The EUT was adjusted to produce maximum available to end user RF output power at the lowest carrier frequency.
- 7.4.2.3 The spectrum analyzer span was set to capture the carrier frequency and associated modulation products. The resolution bandwidth was set wider than 1 % of the frequency span.
- 7.4.2.4 The spectrum analyzer was set in max hold mode and allowed trace to stabilize. The highest emission level within the authorized band was measured.
- 7.4.2.5 The maximum band edge emission and modulation product outside of the band were measured as provided in Table 7.4.2 and associated plots and referenced to the highest emission level measured within the authorized band.
- 7.4.2.6 The above procedure was repeated with the EUT adjusted to produce maximum RF output power at the highest carrier frequency.
- 7.4.2.7 The above procedure was repeated with the frequency hopping function enabled.

Figure 7.4.1 Band edge emission test setup





Test specification: Section 15.247(d) / RSS-247 section 5.5, Band edge emissions			
Test procedure: ANSI C63.10 section 11.12.1			
Test mode: Compliance		Verdict: PASS	
Date(s): 08-Jul-22			
Temperature: 25 °C	Relative Humidity: 58 %	Air Pressure: 1012 hPa	Power: 110 VAC, 50 Hz
Remarks:			

Table 7.4.2 Band edge emission outside restricted band test results

ASSIGNED FREQUENCY RANGE: 2400-2483.5 MHz
DETECTOR USED: Peak
MODULATION: GFSK
BIT RATE: 2 Mbps
RESOLUTION BANDWIDTH: ≥ 1% of the span
VIDEO BANDWIDTH: ≥ RBW

Frequency, MHz	Band edge emission, dBuV/m	Emission at carrier, dBuV/m	Attenuation below carrier, dBc	Limit, dBc	Margin, dB	Verdict
2402	52.78	109.51	56.73	20.0	36.73	Pass

Table 7.4.3 Band edge emission within restricted band test results

Frequency, MHz	Peak field strength			Average field strength			Verdict
	Measured, dB(μV/m)	Limit, dB(μV/m)	Margin, dB*	Calculated field strength dB(μV/m)	Limit, dB(μV/m)	Margin, dB**	
2483.5	43.52	74.0	-38.48	43.52	54.0	-10.48	Pass

*- Margin = Measured field strength - specification limit.

** - Margin = Calculated field strength - specification limit,

Where Calculated field strength = Measured field strength + average factor.

Reference numbers of test equipment used

HL 4355	HL 3903	HL 5902	HL 4933	HL 5622			
---------	---------	---------	---------	---------	--	--	--

Full description is given in Appendix A.



HERMON LABORATORIES

Test specification: Section 15.247(d) / RSS-247 section 5.5, Band edge emissions			
Test procedure: ANSI C63.10 section 11.12.1			
Test mode: Compliance		Verdict: PASS	
Date(s): 08-Jul-22			
Temperature: 25 °C	Relative Humidity: 58 %	Air Pressure: 1012 hPa	Power: 110 VAC, 50 Hz
Remarks:			

Plot 7.4.1 The highest band edge emission at low carrier frequency

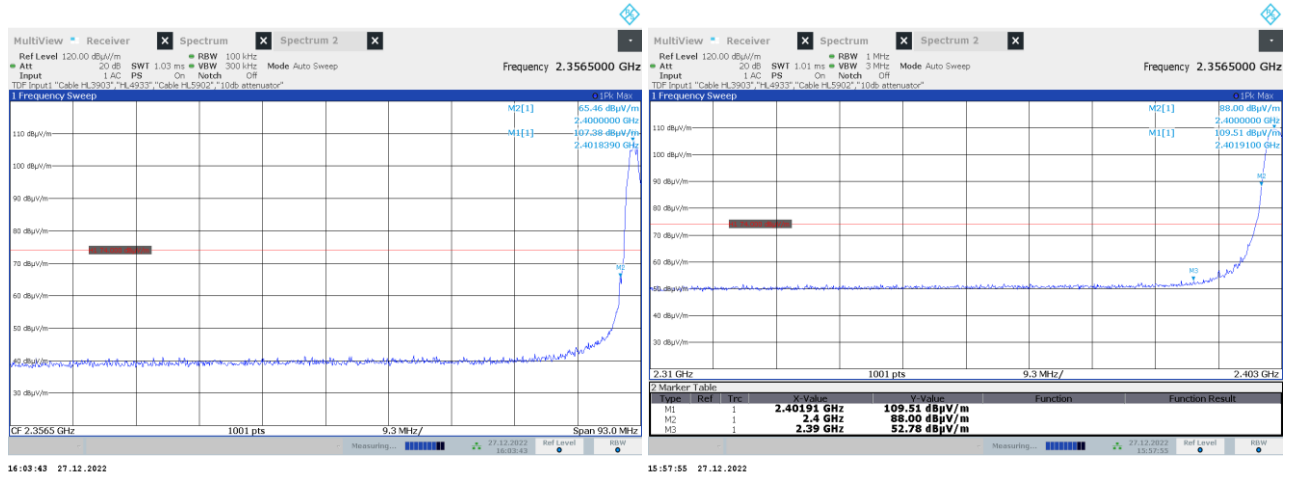

Plot 7.4.2 The highest band edge emission at high carrier frequency

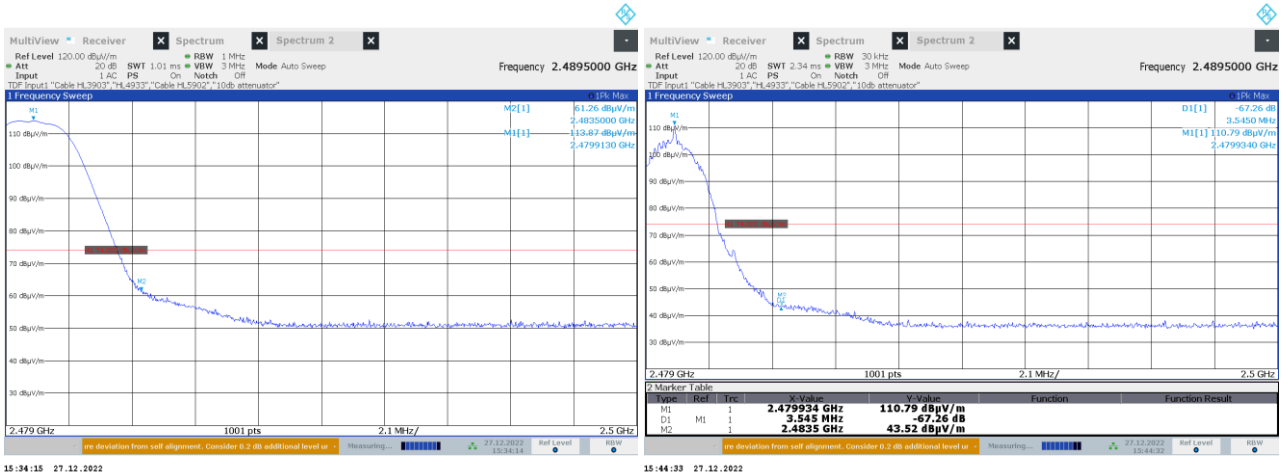



Test specification: Section 15.247(e) / RSS-247 section 5.2(2), Maximum power spectral density			
Test procedure: ANSI C63.10 section 11.10.2			
Test mode: Compliance		Verdict: PASS	
Date(s): 08-Jul-22			
Temperature: 25 °C	Relative Humidity: 58 %	Air Pressure: 1012 hPa	Power: 110 VAC, 50 Hz
Remarks:			

7.5 Peak spectral power density

7.5.1 General

This test was performed to measure the peak spectral power density radiated by the transmitter RF antenna. Specification test limits are given in Table 7.5.1.

Table 7.5.1 Peak spectral power density limits

Assigned frequency range, MHz	Measurement bandwidth, kHz	Peak spectral power density, dBm	Equivalent field strength limit @ 3m, dB(µV/m)*
902.0 – 928.0	3.0	8.0	103.2
2400.0 – 2483.5			
5725.0 – 5850.0			

* - Equivalent field strength limit was calculated from the peak spectral power density as follows: $E = \sqrt{30 \times P} / r$, where P is peak spectral power density and r is antenna to EUT distance in meters.

7.5.2 Test procedure for field strength measurements

7.5.2.1 The EUT was set up as shown in Figure 7.5.1, energized and its proper operation was checked.

7.5.2.2 The EUT was adjusted to produce maximum available to end user RF output power.

7.5.2.3 The field strength of the EUT carrier frequency was measured with antenna connected to spectrum analyzer/ EMI receiver. To find maximum radiation the turntable was rotated 360° and the measuring antenna height was swept in both vertical and horizontal polarizations.

7.5.2.4 The frequency span of spectrum analyzer was set to capture the entire 6 dB band of the transmitter, in peak hold mode with resolution bandwidth set to 3.0 kHz, video bandwidth wider than resolution bandwidth, auto sweep time and sufficient number of sweeps was allowed for trace stabilization. The spectrum lines spacing was verified to be wider than 3 kHz. Otherwise the resolution bandwidth was reduced until individual spectrum lines were resolved and the power of individual spectrum lines was integrated over 3 kHz band.

7.5.2.5 The peak of emission was zoomed with span set just wide enough to capture the emission peak area and sweep time was set equal to span width divided by resolution bandwidth. Spectrum analyzer was set in peak hold mode, sufficient number of sweeps was allowed for trace stabilization and peak spectral power density was measured as provided in Table 7.5.2 and associated plots.



Test specification: Section 15.247(e) / RSS-247 section 5.2(2), Maximum power spectral density			
Test procedure: ANSI C63.10 section 11.10.2			
Test mode: Compliance		Verdict: PASS	
Date(s): 08-Jul-22			
Temperature: 25 °C	Relative Humidity: 58 %	Air Pressure: 1012 hPa	Power: 110 VAC, 50 Hz
Remarks:			

Figure 7.5.1 Setup for carrier field strength measurements

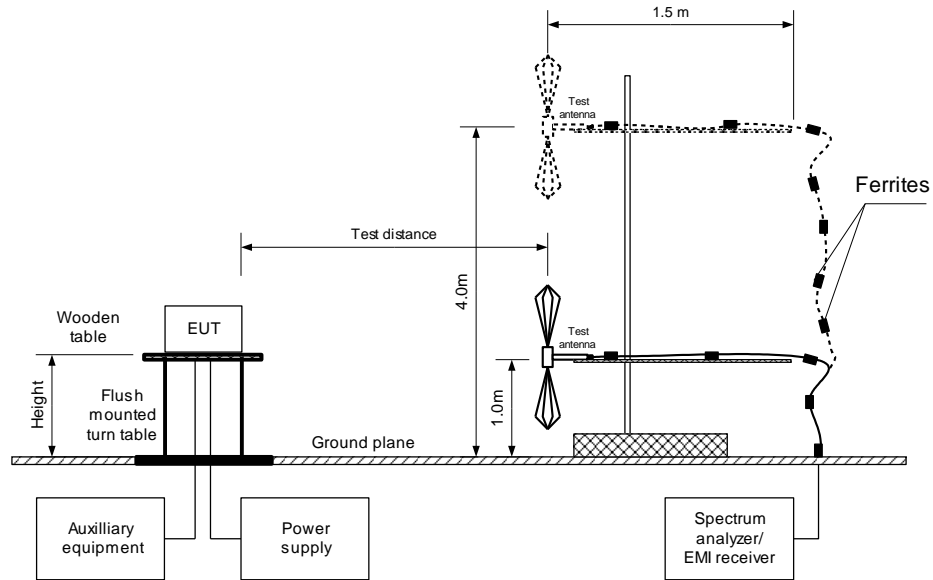



Test specification: Section 15.247(e) / RSS-247 section 5.2(2), Maximum power spectral density			
Test procedure: ANSI C63.10 section 11.10.2			
Test mode: Compliance		Verdict: PASS	
Date(s): 08-Jul-22			
Temperature: 25 °C	Relative Humidity: 58 %	Air Pressure: 1012 hPa	Power: 110 VAC, 50 Hz
Remarks:			

Table 7.5.2 Field strength measurement of peak spectral power density

ASSIGNED FREQUENCY: 2400-2483.5 MHz
TEST DISTANCE: 3 m
TEST SITE: Semi anechoic chamber
EUT HEIGHT: 0.8 m
DETECTOR USED: Peak
RESOLUTION BANDWIDTH: 3 kHz
VIDEO BANDWIDTH: 10 kHz
TEST ANTENNA TYPE: Double ridged guide (above 1000 MHz)
MODULATION: GFSK
TRANSMITTER OUTPUT POWER SETTINGS: Maximum

Frequency, MHz	Field strength, dB(μV/m)	EUT antenna gain, dBi	Limit, dB(μV/m)	Margin, dB*	Antenna polarization	Antenna height, m	Turn-table position**, degrees
2402	97.0	3	103	-6.0	Vertical	1.5	-18
2440	100.3	3	103	-2.7	Horizontal	1.5	25
2480	99.7	3	103	-3.3	Horizontal	1.5	35

*- Margin = Field strength - EUT antenna gain - calculated field strength limit.

** - EUT front panel refer to 0 degrees position of turntable.

Reference numbers of test equipment used

HL 3442	HL 3903	HL 5902	HL 4933				
---------	---------	---------	---------	--	--	--	--

Full description is given in Appendix A.



HERMON LABORATORIES

Test specification: Section 15.247(e) / RSS-247 section 5.2(2), Maximum power spectral density			
Test procedure: ANSI C63.10 section 11.10.2			
Test mode: Compliance		Verdict: PASS	
Date(s): 08-Jul-22			
Temperature: 25 °C	Relative Humidity: 58 %	Air Pressure: 1012 hPa	Power: 110 VAC, 50 Hz
Remarks:			

Plot 7.5.1 Peak spectral power density at low frequency

ANTENNA POLARIZATION: Worst case

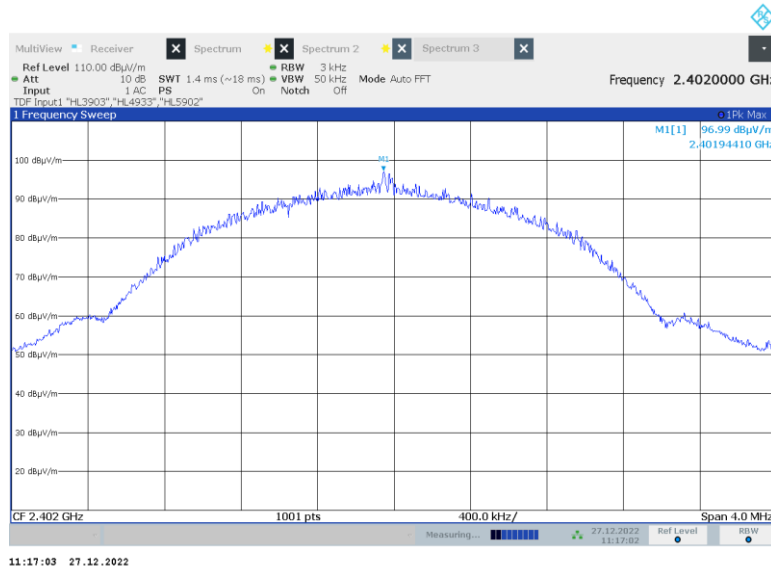

Plot 7.5.2 Peak spectral power density at mid frequency

ANTENNA POLARIZATION: Worst case

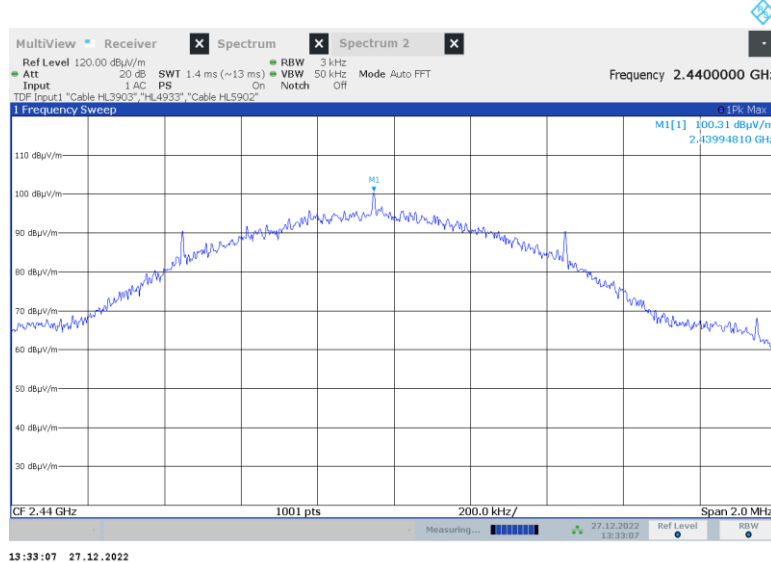



HERMON LABORATORIES

Test specification: Section 15.247(e) / RSS-247 section 5.2(2), Maximum power spectral density			
Test procedure: ANSI C63.10 section 11.10.2			
Test mode: Compliance		Verdict: PASS	
Date(s): 08-Jul-22			
Temperature: 25 °C	Relative Humidity: 58 %	Air Pressure: 1012 hPa	Power: 110 VAC, 50 Hz
Remarks:			

Plot 7.5.3 Peak spectral power density at high frequency

ANTENNA POLARIZATION: Worst case



13:26:49 27.12.2022



Test specification: FCC 47 CFR, Section 15.207 / RSS-Gen sec.8.8, Conducted emissions			
Test procedure: ANSI C63.4, Section 7.3			
Test mode: Compliance		Verdict: PASS	
Date(s): 08-Jul-22			
Temperature: 25 °C	Relative Humidity: 58 %	Air Pressure: 1012 hPa	Power: 110 VAC, 50 Hz
Remarks:			

7.6 Conducted emissions

7.6.1 General

This test was performed to measure the common mode conducted emissions at the EUT power port. The specification test limits are given in Table 7.6.1.

Table 7.6.1 Limits for conducted emissions

Frequency, MHz	Class B limit, dB(μV)		Class A limit, dB(μV)	
	QP	AVRG	QP	AVRG
0.15 - 0.5	66 - 56*	56 - 46*	79	66
0.5 - 5.0	56	46	73	60
5.0 - 30	60	50	73	60

* - The limit decreases linearly with the logarithm of frequency.

7.6.2 Test procedure

- 7.6.2.1 The EUT was set up as shown in Figure 7.6.1 and the associated photographs, energized and the EUT performance was checked.
- 7.6.2.2 The measurements were performed at the EUT power terminals with the LISN connected to the EMI receiver in the frequency range referred to in Table 7.6.2. The unused coaxial connector of the LISN was terminated with 50 Ohm.
- 7.6.2.3 The position of the EUT cables was varied to find the highest emission.
- 7.6.2.4 The worst test results with respect to the limits were recorded in Table 7.6.2 and shown in the associated plots.

Figure 7.6.1 Setup for conducted emission measurements, table-top EUT

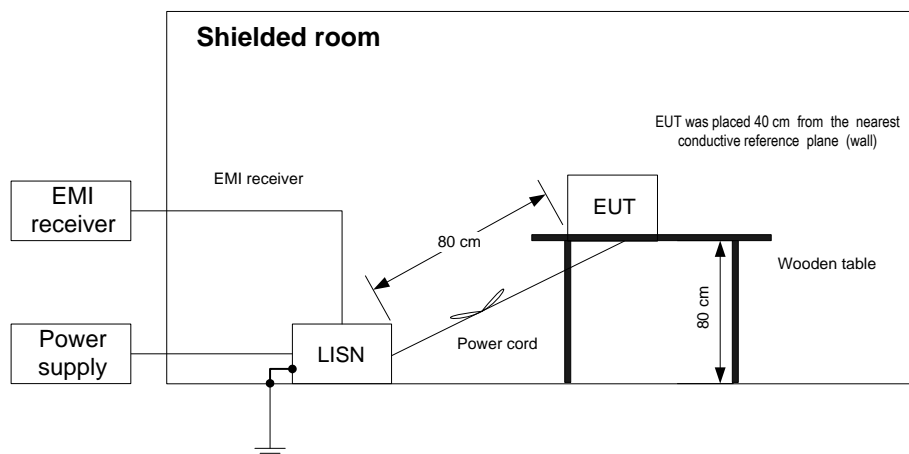



Test specification: FCC 47 CFR, Section 15.207 / RSS-Gen sec.8.8, Conducted emissions			
Test procedure: ANSI C63.4, Section 7.3			
Test mode: Compliance		Verdict: PASS	
Date(s): 08-Jul-22			
Temperature: 25 °C	Relative Humidity: 58 %	Air Pressure: 1012 hPa	Power: 110 VAC, 50 Hz
Remarks:			

Table 7.6.2 Conducted emission test results

LINE: AC mains
EUT SET UP: TABLE-TOP
TEST SITE: SHIELDED ROOM
DETECTORS USED: PEAK / QUASI-PEAK / AVERAGE
FREQUENCY RANGE: 150 kHz - 30 MHz
RESOLUTION BANDWIDTH: 9 kHz

Frequency, MHz	Peak emission, dB(μV)	Quasi-peak			Average			Line ID	Verdict
		Measured emission, dB(μV)	Limit, dB(μV)	Margin, dB*	Measured emission, dB(μV)	Limit, dB(μV)	Margin, dB*		
All emissions are more than 20 dB below the limit								L1	Pass
All emissions are more than 20 dB below the limit								L2	Pass

*- Margin = Measured emission - specification limit.

Reference numbers of test equipment used

HL 0787	HL 1501	HL 3016	HL 5476	HL 5707			
---------	---------	---------	---------	---------	--	--	--

Full description is given in Appendix A.



HERMON LABORATORIES

Test specification: FCC 47 CFR, Section 15.207 / RSS-Gen sec.8.8, Conducted emissions			
Test procedure: ANSI C63.4, Section 7.3			
Test mode: Compliance		Verdict: PASS	
Date(s): 08-Jul-22			
Temperature: 25 °C	Relative Humidity: 58 %	Air Pressure: 1012 hPa	Power: 110 VAC, 50 Hz
Remarks:			

Plot 7.6.1 Conducted emission measurements

LINE: L1
LIMIT: QUASI-PEAK, AVERAGE
DETECTOR: PEAK

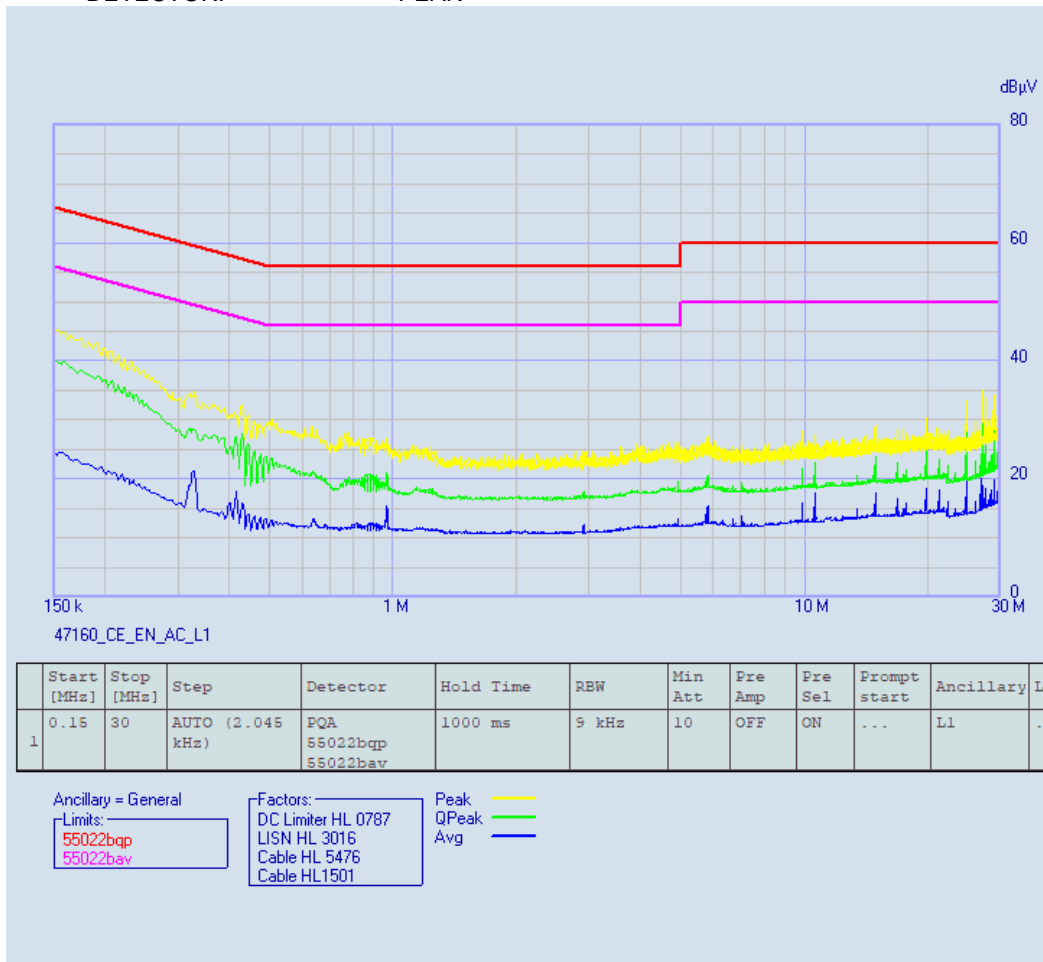



HERMON LABORATORIES

Test specification: FCC 47 CFR, Section 15.207 / RSS-Gen sec.8.8, Conducted emissions			
Test procedure: ANSI C63.4, Section 7.3			
Test mode: Compliance		Verdict: PASS	
Date(s): 08-Jul-22			
Temperature: 25 °C	Relative Humidity: 58 %	Air Pressure: 1012 hPa	Power: 110 VAC, 50 Hz
Remarks:			

Plot 7.6.2 Conducted emission measurements

LINE: L2
LIMIT: QUASI-PEAK, AVERAGE
DETECTOR: PEAK

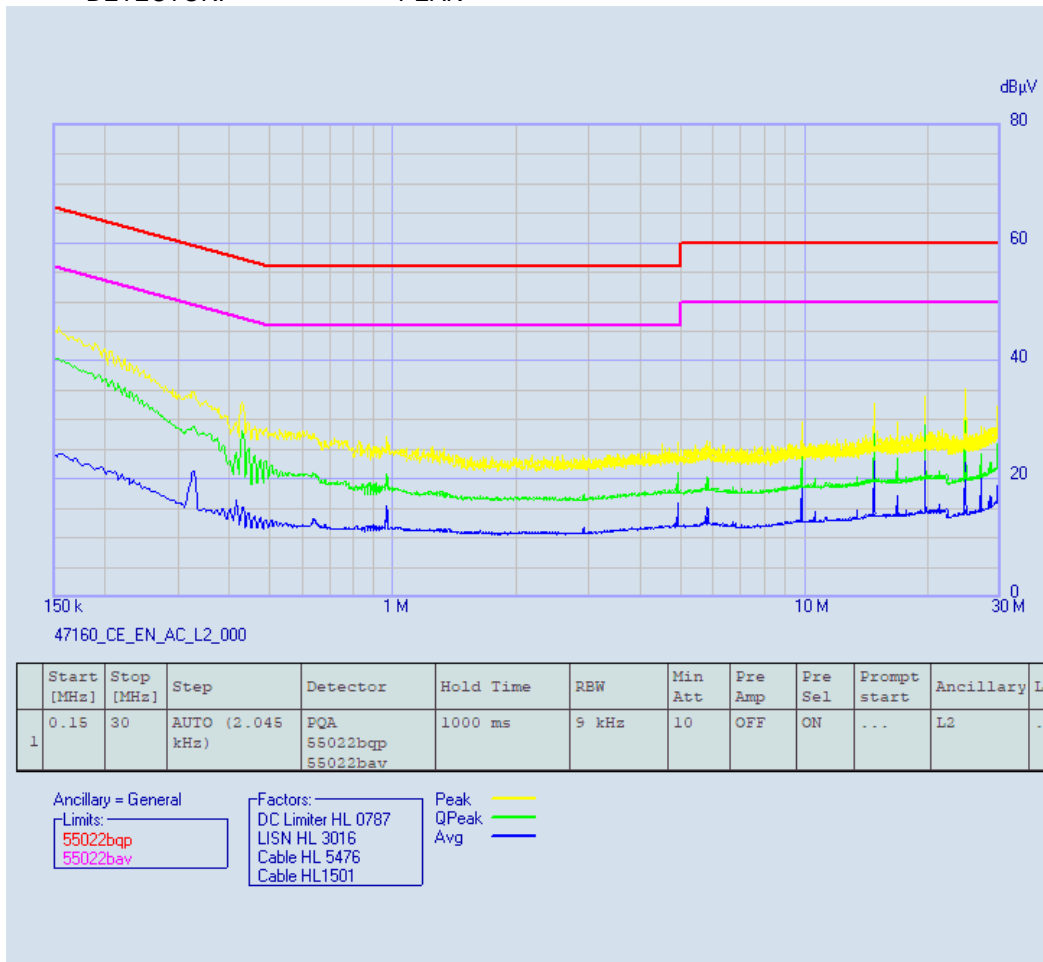



Test specification: Section 15.203, RSS-Gen section 6.8, Antenna requirements			
Test procedure: Visual inspection			
Test mode: Compliance		Verdict: PASS	
Date(s): 21-Jul-22			
Temperature: 25 °C	Relative Humidity: 55 %	Air Pressure: 1012 hPa	Power: 120 VAC, 60 Hz
Remarks:			

7.7 Antenna requirements

The EUT was verified for compliance with antenna requirements. A transmitter shall be designed to ensure that no antenna other than that furnished by the responsible party will be used with the device. It may be either permanently attached or employs a unique antenna connector for every antenna proposed for use with the EUT. This requirement does not apply to professionally installed transmitters. The rationale for compliance with the above requirements was either visual inspection results or supplier declaration. The summary of results is provided in Table 7.7.1.

Table 7.7.1 Antenna requirements

Requirement	Rationale	Verdict
The transmitter antenna is permanently attached	Visual inspection	Comply
The transmitter employs a unique antenna connector	NA	
The transmitter requires professional installation	NA	



Test specification: Section 15.107, ICES-003, Conducted emission at AC power port			
Test procedure: ANSI C63.4, Sections 7.3, 12.2.4			
Test mode: Compliance		Verdict: PASS	
Date(s): 21-Jul-22			
Temperature: 25 °C	Relative Humidity: 55 %	Air Pressure: 1012 hPa	Power: 120 VAC, 60 Hz
Remarks:			

8 Emissions tests according to FCC 47CFR part 15 subpart B and ICES-003 requirements

8.1 Conducted emissions

8.1.1 General

This test was performed to measure the common mode conducted emissions at the EUT power port. The specification test limits are given in Table 8.1.1.

Table 8.1.1 Limits for conducted emissions

Frequency, MHz	Class B limit, dB(μV)		Class A limit, dB(μV)	
	QP	AVRG	QP	AVRG
0.15 - 0.5	66 - 56*	56 - 46*	79	66
0.5 - 5.0	56	46	73	60
5.0 - 30	60	50	73	60

* - The limit decreases linearly with the logarithm of frequency.

8.1.2 Test procedure

- 8.1.2.1 The EUT was set up as shown in Figure 8.1.1 and the associated photographs, energized and the EUT performance was checked.
- 8.1.2.2 The measurements were performed at the EUT power terminals with the LISN connected to the EMI receiver in the frequency range referred to in Table 8.2.1. The unused coaxial connector of the LISN was terminated with 50 Ohm.
- 8.1.2.3 The position of the EUT cables was varied to find the highest emission.
- 8.1.2.4 The worst test results with respect to the limits were recorded in Table 8.2.1 and shown in the associated plots.

Figure 8.1.1 Setup for conducted emission measurements, table-top EUT

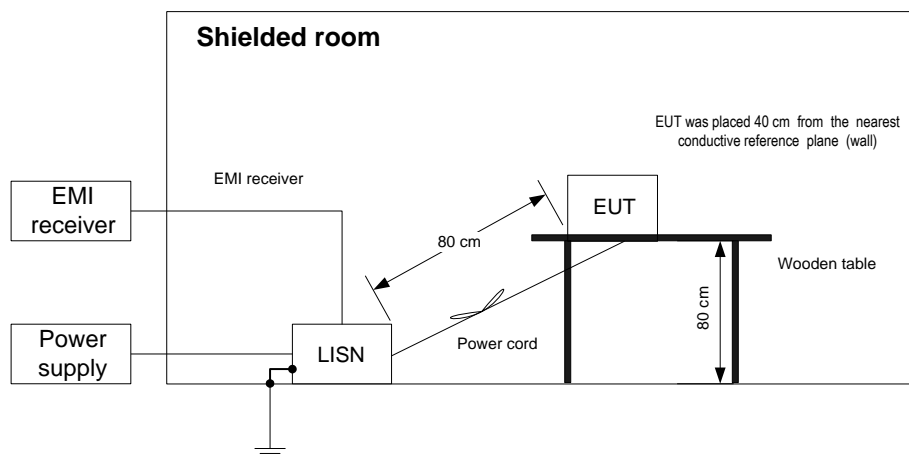



Test specification: Section 15.107, ICES-003, Conducted emission at AC power port			
Test procedure: ANSI C63.4, Sections 7.3, 12.2.4			
Test mode: Compliance		Verdict: PASS	
Date(s): 21-Jul-22			
Temperature: 25 °C	Relative Humidity: 55 %	Air Pressure: 1012 hPa	Power: 120 VAC, 60 Hz
Remarks:			

Table 8.1.2 Conducted emission test results

LINE: AC mains
 EUT SET UP: TABLE-TOP
 TEST SITE: SHIELDED ROOM
 DETECTORS USED: PEAK / QUASI-PEAK / AVERAGE
 FREQUENCY RANGE: 150 kHz - 30 MHz
 RESOLUTION BANDWIDTH: 9 kHz

Frequency, MHz	Peak emission, dB(µV)	Quasi-peak			Average			Line ID	Verdict
		Measured emission, dB(µV)	Limit, dB(µV)	Margin, dB*	Measured emission, dB(µV)	Limit, dB(µV)	Margin, dB*		
All emissions are more than 20 dB below the limit								L1	Pass
All emissions are more than 20 dB below the limit								L2	Pass

*- Margin = Measured emission - specification limit.

Reference numbers of test equipment used

HL 0787	HL 1501	HL 3016	HL 5476	HL 5707			
---------	---------	---------	---------	---------	--	--	--

Full description is given in Appendix A.



HERMON LABORATORIES

Test specification: Section 15.107, ICES-003, Conducted emission at AC power port			
Test procedure: ANSI C63.4, Sections 7.3, 12.2.4			
Test mode: Compliance		Verdict: PASS	
Date(s): 21-Jul-22			
Temperature: 25 °C	Relative Humidity: 55 %	Air Pressure: 1012 hPa	Power: 120 VAC, 60 Hz
Remarks:			

Plot 8.1.1 Conducted emission measurements

LINE: L1
LIMIT: QUASI-PEAK, AVERAGE
DETECTOR: PEAK

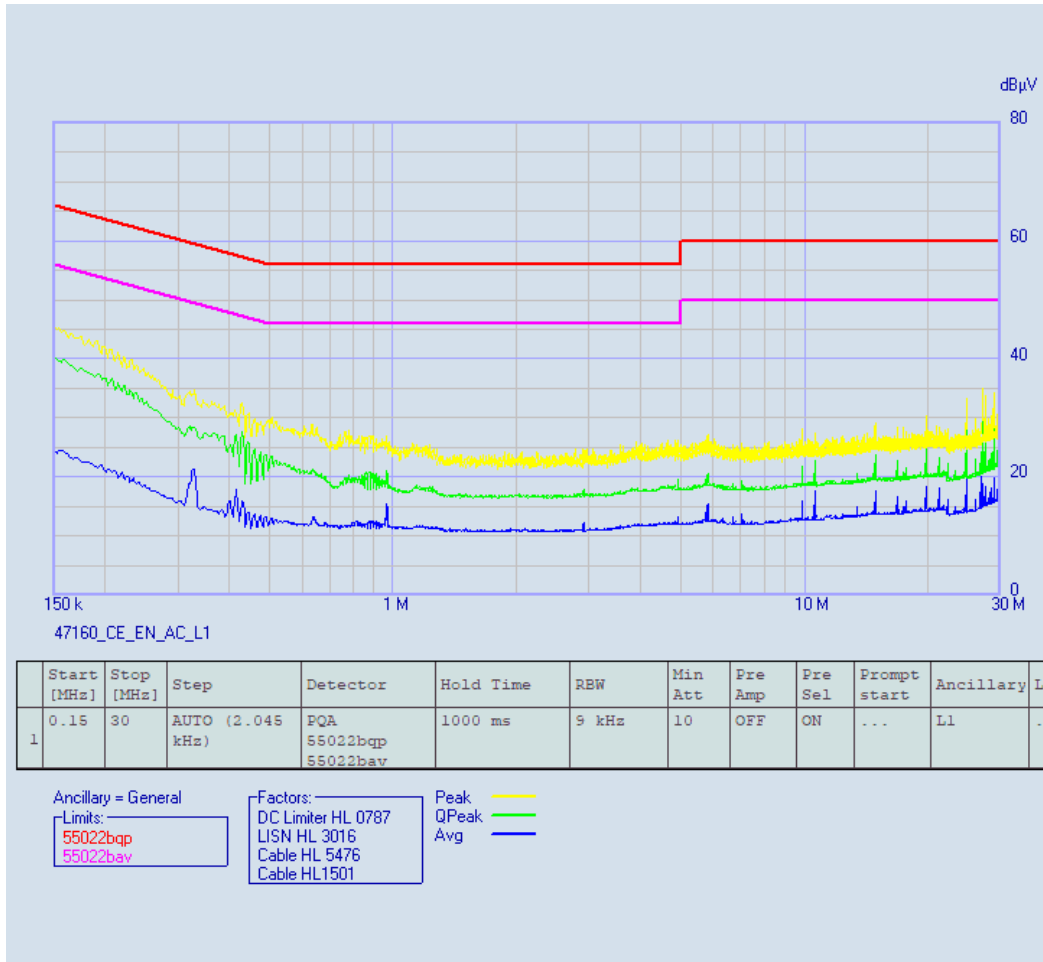



HERMON LABORATORIES

Test specification: Section 15.107, ICES-003, Conducted emission at AC power port			
Test procedure: ANSI C63.4, Sections 7.3, 12.2.4			
Test mode: Compliance		Verdict: PASS	
Date(s): 21-Jul-22			
Temperature: 25 °C	Relative Humidity: 55 %	Air Pressure: 1012 hPa	Power: 120 VAC, 60 Hz
Remarks:			

Plot 8.1.2 Conducted emission measurements

LINE: L2
LIMIT: QUASI-PEAK, AVERAGE
DETECTOR: PEAK

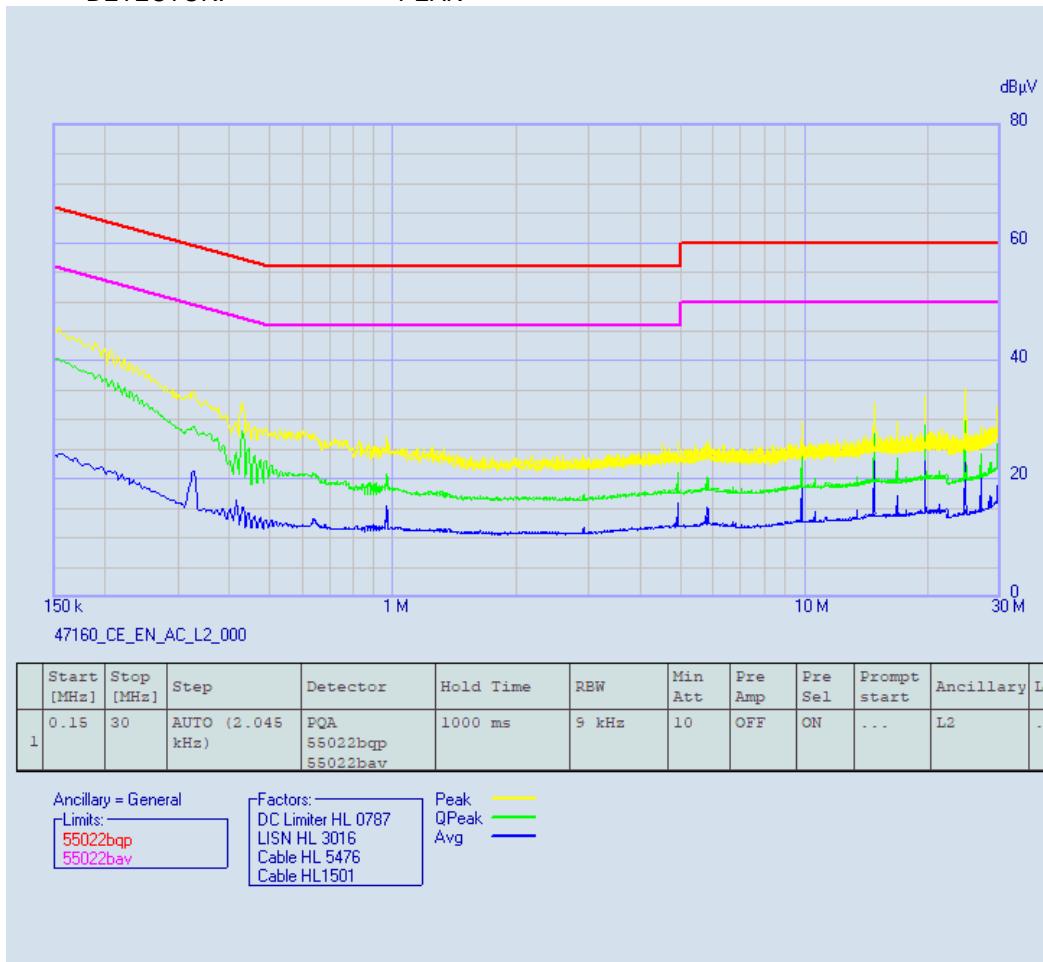



Test specification: Section 15.109 / ICES-003, Radiated emission			
Test procedure: ANSI C63.4, Sections 8.3, 12.2.5			
Test mode: Compliance		Verdict: PASS	
Date(s): 21-Jul-22			
Temperature: 25 °C	Relative Humidity: 55 %	Air Pressure: 1012 hPa	Power: 120 VAC, 60 Hz
Remarks:			

8.2 Radiated emission measurements

8.2.1 General

This test was performed to measure radiated emissions from the EUT enclosure. The specification test limits are given in Table 8.2.1.

Table 8.2.1 Radiated emission test limits

Frequency, MHz	Class B limit, dB(μ V/m)		Class A limit, dB(μ V/m)	
	10 m distance	3 m distance	10 m distance	3 m distance
30 - 88	29.5*	40.0	39.0	49.5*
88 - 216	33.0*	43.5	43.5	54.0*
216 - 960	35.5*	46.0	46.4	56.9*
Above 960	43.5*	54.0	49.5	60.0*

* - The limit for a test distance other than specified was calculated using the inverse linear distance extrapolation factor as follows: $Lims_2 = Lims_1 + 20 \log(S_1/S_2)$, where S_1 and S_2 – the standard defined and the test distance respectively in meters.

8.2.2 Test procedure for measurements in semi-anechoic chamber

8.2.2.1 The EUT was set up as shown in Figure 8.2.1 and the associated photographs, energized and the EUT performance was checked.

8.2.2.2 The measurements were performed in the anechoic chamber at 3 m test distance. The specified frequency range was investigated with the antenna connected to the EMI receiver. To find the highest emission the turntable was rotated 360° and the measuring antenna height was swept from 1 to 4 m in both, vertical and horizontal polarizations. The EUT cables position was varied to maximize emission.

8.2.2.3 The worst test results with respect to the limits were recorded in Table 8.2.2 and shown in the associated plots.



Test specification: Section 15.109 / ICES-003, Radiated emission			
Test procedure: ANSI C63.4, Sections 8.3, 12.2.5			
Test mode: Compliance		Verdict: PASS	
Date(s): 21-Jul-22			
Temperature: 25 °C	Relative Humidity: 55 %	Air Pressure: 1012 hPa	Power: 120 VAC, 60 Hz
Remarks:			

8.2.2.4 Figure 8.2.1 Setup for radiated emission measurements in anechoic chamber, table-top EUT

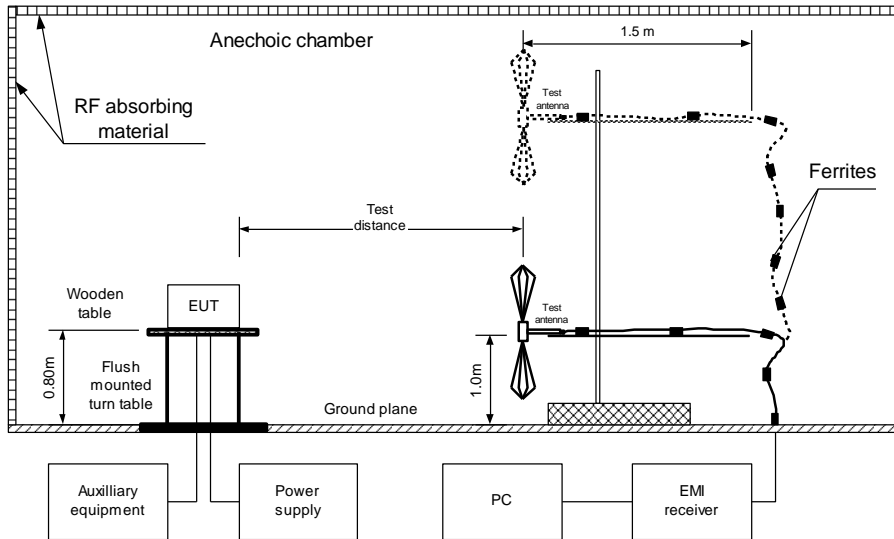
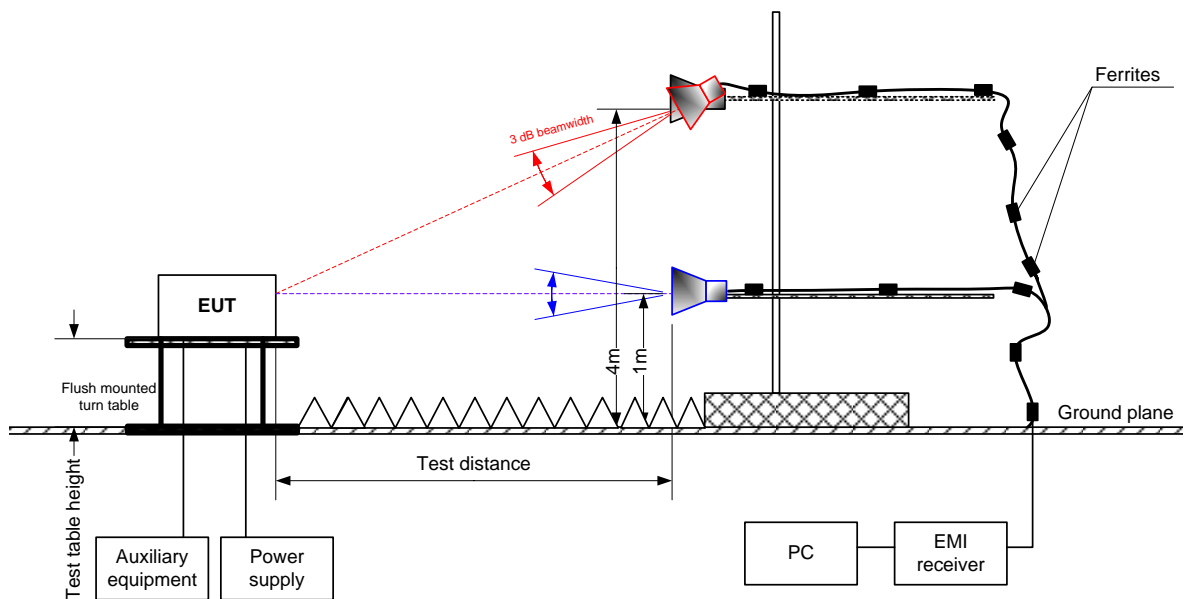

Figure 8.2.2 Setup for radiated emission measurements in 1000 – 40000 MHz range, table-top EUT





Test specification: Section 15.109 / ICES-003, Radiated emission			
Test procedure: ANSI C63.4, Sections 8.3, 12.2.5			
Test mode: Compliance		Verdict: PASS	
Date(s): 21-Jul-22			
Temperature: 25 °C	Relative Humidity: 55 %	Air Pressure: 1012 hPa	Power: 120 VAC, 60 Hz
Remarks:			

Table 8.2.2 Radiated emission test results

EUT SET UP: TABLE-TOP
 TEST SITE: OATS / SEMI ANECHOIC CHAMBER
 TEST DISTANCE: 10 m
 DETECTORS USED: PEAK / QUASI-PEAK
 FREQUENCY RANGE: 30 MHz – 1000 MHz
 RESOLUTION BANDWIDTH: 120 kHz

Frequency, MHz	Peak emission, dB(µV/m)	Quasi-peak			Antenna polarization	Antenna height, m	Turn-table position**, degrees	Verdict
		Measured emission, dB(µV/m)	Limit, dB(µV/m)	Margin, dB*				
43.287	31.19	27.24	40.0	-12.76	Vertical	1.02	129	Pass
197.664	41.39	36.49	43.5	-7.01	Vertical	1.02	42	
200.369	42.84	37.68	43.5	-5.82	Vertical	1.02	-56	
200.441	41.83	37.01	43.5	-6.49	Vertical	1.02	42	
200.495	43.07	37.90	43.5	-5.60	Vertical	1.00	-56	
388.087	39.44	32.28	46.0	-13.72	Horizontal	1.00	166	

TEST SITE: SEMI ANECHOIC CHAMBER
 TEST DISTANCE: 3 m
 DETECTORS USED: PEAK / AVERAGE
 FREQUENCY RANGE: 1000 MHz – 13000 MHz
 RESOLUTION BANDWIDTH: 1000 kHz

Frequency, MHz	Peak			Average			Antenna polarization	Antenna tilt, degrees	Antenna height, m	Turn-table position**, degrees	Verdict
	Measured emission, dB(µV/m)	Limit, dB(µV/m)	Margin, dB*	Measured emission, dB(µV/m)	Limit, dB(µV/m)	Margin, dB*					
All emissions are more than 20 dB below the limit											Pass

*- Margin = Measured emission - specification limit.
 **- EUT front panel refers to 0 degrees position of turntable.

Reference numbers of test equipment used

HL 3903	HL 4360	HL 4933	HL 5288			
---------	---------	---------	---------	--	--	--

Full description is given in Appendix A.



Test specification: Section 15.109 / ICES-003, Radiated emission			
Test procedure: ANSI C63.4, Sections 8.3, 12.2.5			
Test mode: Compliance		Verdict: PASS	
Date(s): 21-Jul-22			
Temperature: 25 °C	Relative Humidity: 55 %	Air Pressure: 1012 hPa	Power: 120 VAC, 60 Hz
Remarks:			

Plot 8.2.1 Radiated emission measurements in 30 - 1000 MHz range

TEST SITE: Semi Anechoic chamber
 TEST DISTANCE: 3 m
 ANTENNA POLARIZATION: Vertical & Horizontal

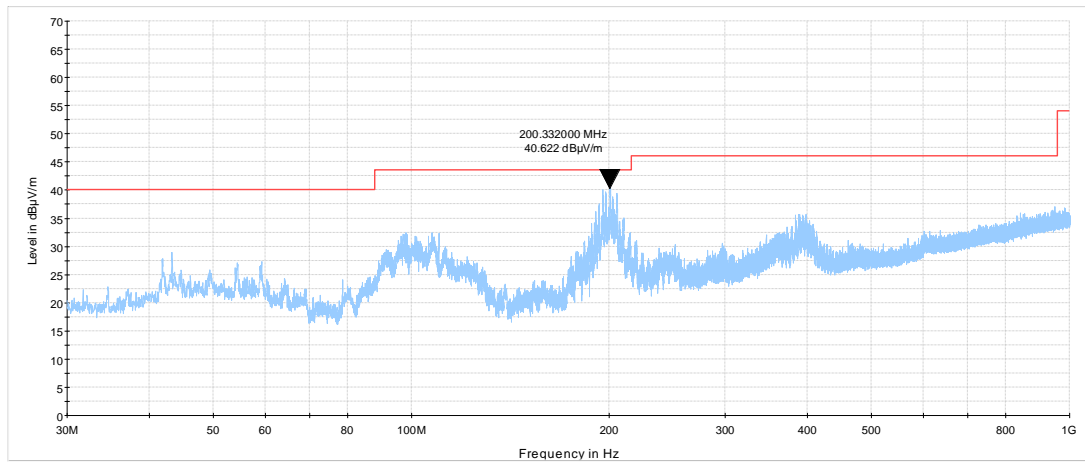

Plot 8.2.2 Radiated emission measurements above 1000 MHz

TEST SITE: Semi Anechoic chamber
 TEST DISTANCE: 3 m
 ANTENNA POLARIZATION: Vertical & Horizontal

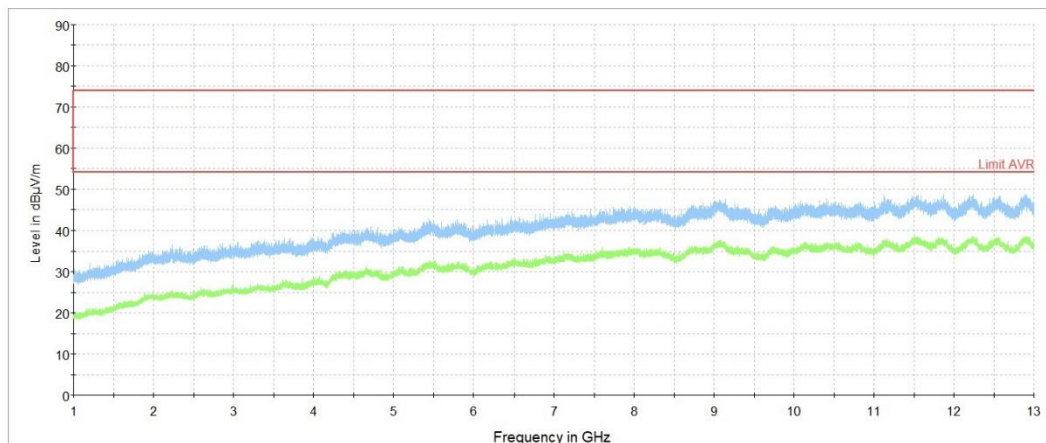

**9 APPENDIX A Test equipment and ancillaries used for tests**

HL No	Description	Manufacturer	Model	Ser. No.	Last Cal./ Check	Due Cal./ Check
0337	Probe Set, Hand held, 5 probes	Electro-Metrics	EHFP-30	238	30-May-22	30-May-23
0787	Transient Limiter 9 kHz-200 MHz	Hewlett Packard	11947A	3107A01877	04-Oct-21	04-Oct-22
1501	Cable RF, 6 m, BNC/BNC	Belden	M17/167 MIL-C-17	1501	11-Oct-21	11-Oct-22
3016	LISN, Two-line V-network, 9 kHz to 30 MHz, (50 uH+5 Ohm), CISPR16-1, MIL-461E	Rohde & Schwarz	ESH 3-Z5	892239/002	08-Feb-22	08-Feb-23
3437	Precision Fixed Attenuator, 50 Ohm, 5 W, 10 dB, DC to 18 GHz	Mini-Circuits	BW-S10W5+	NA	13-Sep-21	13-Sep-22
3818	PSA Series Spectrum Analyzer, 3 Hz- 44 GHz	Agilent Technologies	E4446A	MY48250288	02-Aug-21	02-Aug-22
3903	Microwave Cable Assembly, 40.0 GHz, 1.5 m, SMA/SMA	Huber-Suhner	SUCOFLEX 102A	1226/2A	07-Apr-22	07-Apr-23
4114	Antenna, Double-Ridged Waveguide Horn, 1 to 18 GHz	ETS Lindgren	3117	00123515	08-Jun-22	08-Jun-23
4136	Shield Box	TESCOM CO., LTD	TC-5916A	5916A000137	28-Apr-22	28-Apr-23
4355	Signal and Spectrum Analyzer, 9 kHz to 7 GHz	Rohde & Schwarz	FSV 7	101630	20-Sep-21	20-Sep-22
4360	EMI Test Receiver, 20 Hz to 40 GHz.	Rohde & Schwarz	ESU40	100322	13-Jan-22	13-Jan-23
4372	High Pass Filter, 50 Ohm, 8.0 to 18.0 GHz,SMA-FM / SMA-FM	Tiger Micro-Electronics Institute	TGF-A2118-001	r-JSFG308-001	15-Jun-21	15-Jun-23
4529	High Pass Filter, 50 Ohm, 4250 to 10000 MHz., SMA-FM / SMA-M	Mini-Circuits	VHF-3800+	NA	15-Jun-21	15-Jun-23
4933	Active Horn Antenna, 1 GHz to 18 GHz	COM-POWER CORPORATION	AHA-118	701046	13-Jan-22	13-Jan-23
5112	RF cable, 40 GHz, 5.5 m, K-type	Huber-Suhner	SF102EA/11 SK/11SK/55 00MM	502494/2EA	25-Apr-22	25-Apr-23
5288	Trilog Antenna, 25 MHz - 8 GHz, 100W	Frankonia	ALX-8000E	00809	24-Mar-22	24-Apr-25
5376	EXA Signal Analyzer, 10 Hz - 32 GHz	Keysight Technologies	N9010B	MY57470404	01-Nov-21	01-Nov-22
5397	H-field near field probe, 3 cm	ETS Lindgren	7405-902	NA	16-Aug-20	16-Aug-22
5476	Cable, BNC/BNC, 10.5 m	Western wire	MIL-C-17G	NA	22-May-22	22-May-23
5608	Precision Fixed Attenuator, 50 Ohm, 5 W, 10 dB, DC to 18 GHz	Mini Circuits	BW-S10W5+	NA	13-Sep-21	13-Sep-22
5622	Precision Fixed Attenuator, 50 Ohm, 5 W, 20 dB, DC to 18 GHz	Mini Circuits	BW-N20W5+	NA	06-Oct-19	06-Oct-20
5645	Cable, 50 Ohm, DC to 18 GHz, 1.8 m, SMA/SMA	Mini Circuits	CBL-6FT-SMSM+	NA	01-Nov-21	01-Nov-22
5707	EMI receiver	PMM / Narda	PMM 9010F	060WW91101	02-Feb-22	02-Feb-23
5902	RF cable, 18 GHz, 6.0m, N-type	Huber-Suhner	SF126EA/11 N/11N/6000	NA	16-Jan-22	16-Jan-23



10 APPENDIX B Test equipment correction factors

HL 5288: Trilog Antenna
Frankonia, model: ALX-8000E, s/n: 00809
30-1000 MHz

Frequency, MHz	Antenna factor, dB/m
30	14.96
35	15.33
40	16.37
45	17.56
50	17.95
60	16.87
70	13.22
80	10.56
90	13.61
100	15.46
120	14.03
140	12.23

Frequency, MHz	Antenna factor, dB/m
160	12.67
180	13.34
200	15.40
250	16.42
300	17.28
400	19.98
500	21.11
600	22.90
700	24.13
800	25.25
900	26.35
1000	27.18

The antenna factor shall be added to receiver reading in dB μ V to obtain field strength in dB μ V/m.
above 1000 MHz

Frequency, MHz	Antenna factor, dB/m
1000	26.9
1100	28.1
1200	28.4
1300	29.6
1400	29.1
1500	30.4
1600	30.7
1700	31.5
1800	32.3
1900	32.6
2000	32.5
2100	32.9
2200	33.5
2300	33.2
2400	33.7
2500	34.6
2600	34.7
2700	34.6
2800	35.0
2900	35.5
3000	36.2
3100	36.8
3200	36.8
3300	37.0
3400	37.5
3500	38.2

Frequency, MHz	Antenna factor, dB/m
3600	38.9
3700	39.4
3800	39.4
3900	39.6
4000	39.7
4100	39.8
4200	40.5
4300	40.9
4400	41.1
4500	41.4
4600	41.3
4700	41.6
4800	41.9
4900	42.3
5000	42.7
5100	43.0
5200	42.9
5300	43.5
5400	43.6
5500	44.3
5600	44.7
5700	45.0
5800	45.0
5900	45.3
6000	45.9

The antenna factor shall be added to receiver reading in dB μ V to obtain field strength in dB μ V/m.



HL 4933: Active Horn Antenna
COM-POWER CORPORATION, model: AHA-118, s/n 701046

Frequency, MHz	Measured antenna factor (with preamplifier), dB/m
1000	-16.1
1500	-15.1
2000	-10.9
2500	-11.9
3000	-11.1
3500	-10.6
4000	-8.6
4500	-8.3
5000	-5.9
5500	-5.7
6000	-3.3
6500	-4.0
7000	-2.2
7500	-1.7
8000	1.1
8500	-0.8
9000	-1.5
9500	-0.2

Frequency, MHz	Measured antenna factor (with preamplifier), dB/m
10000	1.8
10500	1.0
11000	0.3
11500	-0.5
12000	3.1
12500	1.4
13000	-0.3
13500	-0.4
14000	2.5
14500	2.2
15000	1.9
15500	0.5
16000	2.1
16500	1.2
17000	0.6
17500	3.1
18000	4.2

The antenna factor shall be added to receiver reading in dB μ V to obtain field strength in dB μ V/m.



11 APPENDIX C Measurement uncertainties

Expanded uncertainty at 95% confidence in Hermon Labs EMC measurements

Test description	Expanded uncertainty
Conducted carrier power at RF antenna connector	Below 12.4 GHz: ± 1.7 dB 12.4 GHz to 40 GHz: ± 2.3 dB
Conducted emissions at RF antenna connector	9 kHz to 2.9 GHz: ± 2.6 dB 2.9 GHz to 6.46 GHz: ± 3.5 dB 6.46 GHz to 13.2 GHz: ± 4.3 dB 13.2 GHz to 22.0 GHz: ± 5.0 dB 22.0 GHz to 26.8 GHz: ± 5.5 dB 26.8 GHz to 40.0 GHz: ± 4.8 dB
Occupied bandwidth	± 8.0 %
Duty cycle, timing (Tx ON / OFF) and average factor measurements	± 1.0 %
Conducted emissions with LISN	9 kHz to 150 kHz: ± 3.9 dB 150 kHz to 30 MHz: ± 3.8 dB
Radiated emissions at 3 m measuring distance Horizontal polarization Vertical polarization	Biconilog antenna: ± 5.3 dB Biconical antenna: ± 5.0 dB Log periodic antenna: ± 5.3 dB Double ridged horn antenna: ± 5.3 dB Biconilog antenna: ± 6.0 dB Biconical antenna: ± 5.7 dB Log periodic antenna: ± 6.0 dB Double ridged horn antenna: ± 6.0 dB

Hermon Laboratories is accredited by A2LA for calibration according to present requirements of ISO/IEC 17025 and NCSL Z540-1. The accreditation is granted to perform calibration of parameters that are listed in the Scope of Hermon Laboratories Accreditation.

Hermon Laboratories calibrates its reference and transfer standards by calibration laboratories accredited to ISO/IEC 17025 by a mutually recognized Accreditation Body or by a recognized national metrology institute. All reference and transfer standards used in the calibration system are traceable to national or international standards.

In-house calibration of all test and measurement equipment is performed on a regular basis according to Hermon Laboratories calibration procedures, manufacturer calibration/verification procedures or procedures defined in the relevant standards. The Hermon Laboratories test and measurement equipment is calibrated within the tolerances specified by the manufacturers and/or by the relevant standards.



12 APPENDIX D Test laboratory description

Tests were performed at Hermon Laboratories Ltd., which is a fully independent, private, EMC, Radio, Safety, Environmental and Telecommunication testing facility.

Hermon Laboratories is recognized and accredited by the Federal Communications Commission (USA) for relevant parts of Code of Federal Regulations 47 (CFR 47), Test Firm Registration Number is 927748, Designation Number is IL1001; Recognized by Innovation, Science and Economic Development Canada for wireless and terminal testing (ISED), ISED #2186A, CAB identifier is IL1001; Certified by VCCI, Japan (the registration numbers are R-10808 for OATS, R-1082 for anechoic chamber, G-10869 for RE measurements above 1 GHz, C-10845 for conducted emissions site and T-11606 for conducted emissions at telecommunication ports).

The laboratory is accredited by American Association for Laboratory Accreditation (USA) according to ISO/IEC 17025 for electromagnetic compatibility, product safety, telecommunications testing, environmental simulation and calibration (for exact scope please refer to Certificate No. 839.01, 839.03 and 839.04).

Address: P.O. Box 23, Binyamina 3055001, Israel.
Telephone: +972 4628 8001
Fax: +972 4628 8277
e-mail: mail@hermonlabs.com
website: www.hermonlabs.com

Person for contact: Mr. Michael Nikishin, EMC&Radio group manager

13 APPENDIX E Specification references

FCC 47CFR part 15: 2020	Radio Frequency Devices
ANSI C63.10: 2013	American National Standard of Procedures for Compliance Testing of Unlicensed Wireless Devices
ANSI C63.4: 2014	American National Standard for Methods of Measurement of Radio-Noise Emissions from Low-Voltage Electrical and Electronic Equipment in the Range of 9 kHz to 40 GHz.
RSS-247 Issue 2: 2017	Digital Transmission Systems (DTSs), Frequency Hopping Systems (FHSs) and Licence- Exempt Local Area Network (LE-LAN) Devices
RSS-Gen Issue 5 with_amendment_1_2: 2021	General Requirements and Information for the Certification of Radiocommunication Equipment
ICES-003: 2020, Issue 7	Information Technology Equipment (Including Digital Apparatus) – Limits and methods of measurement



14 APPENDIX F Abbreviations and acronyms

A	ampere
AC	alternating current
A/m	ampere per meter
AM	amplitude modulation
AVRG	average (detector)
cm	centimeter
dB	decibel
dBm	decibel referred to one milliwatt
dB(μ V)	decibel referred to one microvolt
dB(μ V/m)	decibel referred to one microvolt per meter
dB(μ A)	decibel referred to one microampere
DC	direct current
EIRP	equivalent isotropically radiated power
ERP	effective radiated power
EUT	equipment under test
F	frequency
GHz	gigahertz
GND	ground
H	height
HL	Hermon laboratories
Hz	hertz
k	kilo
kHz	kilohertz
LO	local oscillator
m	meter
MHz	megahertz
min	minute
mm	millimeter
ms	millisecond
μ s	microsecond
NA	not applicable
NB	narrow band
OATS	open area test site
Ω	Ohm
PM	pulse modulation
PS	power supply
ppm	part per million (10^{-6})
QP	quasi-peak
RE	radiated emission
RF	radio frequency
rms	root mean square
Rx	receive
s	second
T	temperature
Tx	transmit
V	volt
WB	wideband

END OF DOCUMENT