

TEST REPORT

ACCORDING TO: FCC CFR 47 Part 15 subpart C, section 15.231 and subpart B,
RSS-210 issue 10 Annex A, ICES-003 Issue 6:2017

FOR:

Essence Smartcare Ltd.

Multi-Dimensional Sense

Model: ES700MDS

FCC ID: 2ARFP-ES700MDS

IC: 24417-ES700MDS

This report is in conformity with ISO/IEC 17025. The "A2LA Accredited" symbol endorsement applies only to the tests and calibrations that are listed in the scope of Hermon Laboratories accreditation. The test results relate only to the items tested. This test report shall not be reproduced in any form except in full with the written approval of Hermon Laboratories Ltd.

Table of contents

1	Applicant information	3
2	Equipment under test attributes	3
3	Manufacturer information	3
4	Test details	3
5	Tests summary	4
6	EUT description	5
6.1	General information	5
6.2	Test configuration	5
6.3	Changes made in EUT	5
6.4	Transmitter characteristics	6
7	Transmitter tests according to 47CFR part 15 subpart C and RSS-210 requirements	7
7.1	Periodic operation requirements	7
7.2	Field strength of emissions	10
7.3	Occupied bandwidth test	21
7.4	Conducted emissions	23
7.5	Antenna requirements	26
8	Emissions tests according to FCC 47CFR part 15 subpart B and ICES-003 requirements	27
8.1	Conducted emissions	27
8.2	Radiated emission measurements	30
9	APPENDIX A Test equipment and ancillaries used for tests	34
10	APPENDIX B Test equipment correction factors	35
11	APPENDIX C Measurement uncertainties	38
12	APPENDIX D Test laboratory description	39
13	APPENDIX E Specification references	40
14	APPENDIX F Abbreviations and acronyms	41

1 Applicant information

Client name: Essence Smartcare Ltd.
Address: 12 Abba Eban avenue, Ackerstein Tower Bldg. D, P.O.Box 2073, Herzliya 4612001, Israel
Telephone: +972 732 447 735
Fax: +972 9772 9962
E-mail: israelgo@essence-grp.com
Contact name: Mr. Israel Gottesman

2 Equipment under test attributes

Product name: Multi-Dimensional Sense
Product type: Transceiver
Model: ES700MDS
Serial number: 001
Hardware version: 1.0
Software release: 2.01
Receipt date 06-Jul-20

3 Manufacturer information

Manufacturer name: Essence Smartcare Ltd.
Address: 12 Abba Eban avenue, Ackerstein Tower Bldg. D, P.O.Box 2073, Herzliya 4612001, Israel
Telephone: +972 732 447 735
Fax: +972 9772 9962
E-Mail: israelgo@essence-grp.com
Contact name: Mr. Israel Gottesman

4 Test details



Project ID: 37527
Location: Primary: Hermon Laboratories Ltd. P.O. Box 23, Binyamina 3055001, Israel
Satellite: Hermon Laboratories Ltd. Hefetz-Haim 10, Tel Aviv 6744124, Israel
Test started: 07-Jul-20
Test completed: 23-Jul-20
Test specification: FCC 47CFR part 15, subpart C, §15.231 and subpart B;
RSS-210 issue 10 Annex 1, RSS-Gen issue 5, ICES-003 issue 6:2017

5 Tests summary

Test	Status
Transmitter characteristics	
FCC Part 15, Section 231(a) / RSS-210, Section A1.1, Periodic operation requirements	Pass
FCC Part 15, Section 231(a) / RSS-210, Section A1.2, Field strength of emissions	Pass
FCC Part 15, Section 231(c) / RSS-210, Section A1.3, Occupied bandwidth	Pass
FCC Part 15, Section 207 / RSS-Gen, Section 8.8, Conducted emission	Pass
FCC Part 15, Section 203 / RSS-Gen, Section 6.8, Antenna requirements	Pass
Unintentional emissions	
FCC Part 15, Section 107 / ICES-003, Section 6.1 class B, Conducted emission at AC power port	Pass
FCC Part 15, Section 109 / RSS-Gen, Section 7.3 / ICES-003, Section 6.2 class B, Radiated emission	Pass

Testing was completed against all relevant requirements of the test standard. The results obtained indicate that the product under test complies in full with the requirements tested.

The test results relate only to the items tested. Pass/fail decision was based on nominal values.

	Name and Title	Date	Signature
Tested by:	Mr. I. Zilberstein, test engineer, EMC & Radio	07-Jul-20 – 23-Jul-20	
Reviewed by:	Mrs. S. Peysahov Sheynin, test engineer, EMC & Radio	03-Aug-20	
Approved by:	Mr. S. Samokha, technical manager, EMC & Radio	06-Sep-20	

6 EUT description

Note: The following data in this clause is provided by the customer and represents his sole responsibility

6.1 General information

The EUT, ES700MDS is a wireless fall detection device, comprises RF module operating at 916.5MHz and has two Configurations: with non-charging batteries, or with power supply.

6.2 Test configuration

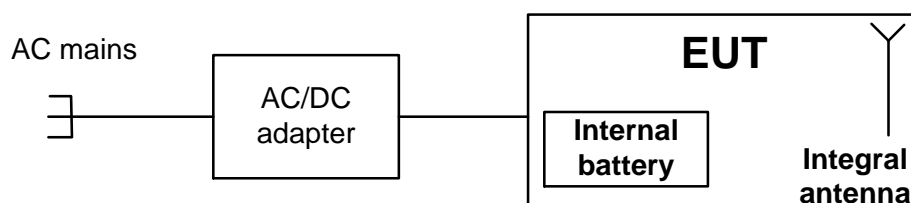

6.3 Changes made in EUT

No changes were implemented in the EUT during testing.

6.4 Transmitter characteristics

Type of equipment						
X	Stand-alone (Equipment with or without its own control provisions)					
	Combined equipment (Equipment where the radio part is fully integrated within another type of equipment)					
	Plug-in card (Equipment intended for a variety of host systems)					
Operating frequency		916.5 MHz				
Maximum rated output power		At transmitter 50 Ω RF output connector				
		Field strength at 3 m distance			101.34 dB(μ V/m) – peak 78.58 dB(μ V/m) -average	
Is transmitter output power variable?		X	No			
			Yes	continuous variable		
				stepped variable with stepsize		dB
				minimum RF power		dBm
		maximum RF power		dBm		
Antenna connection						
unique coupling	standard connector	X	integral	with temporary RF connector		
				X without temporary RF connector		
Antenna/s technical characteristics						
Type	Manufacturer	Model number		Gain		
Integral	Essence Security	printed		0 dBi		
Transmitter aggregate data rate/s		2FSK				
Type of modulation		38.4 kbps				
Transmitter power source						
X	Battery	Nominal rated voltage	6 VDC	Battery type	Alkaline	
	DC	Nominal rated voltage	VDC			
X	AC mains	Nominal rated voltage	120 VAC	Frequency	50 Hz	
Common power source for transmitter and receiver				X	yes	no



Test specification:	FCC Part 15, Section 231(a) / RSS-210, Section A1.1, Periodic operation requirements		
Test procedure:	Supplier declaration		
Test mode:	Compliance	Verdict: PASS	
Date(s):	07-Jul-20 - 23-Jul-20		
Temperature: 25.1 °C	Relative Humidity: 49 %	Air Pressure: 1005 hPa	Power: 120 VAC, 50 Hz
Remarks:			

7 Transmitter tests according to 47CFR part 15 subpart C and RSS-210 requirements

7.1 Periodic operation requirements

7.1.1 General

The EUT was verified for compliance with periodic operation requirements listed below:

- Continuous transmissions such as voice, video and the radio control of toys are not permitted;
- A manually operated transmitter shall employ switch that will automatically deactivate the transmitter within not more than 5 seconds of being released;
- A transmitter activated automatically shall cease transmission within 5 seconds after activation;
- Periodic transmissions, excluding polling or supervision transmissions, at regular predetermined intervals are not permitted;
- Total duration of polling or supervision transmissions, including data, to determine system integrity in security or safety applications shall not exceed 2 seconds per hour;
- Transmission of set-up information for security systems may exceed the transmission duration limits of 5 seconds, provided such transmissions are under the control of a professional installer and do not exceed ten seconds after a manually operated switch is released or a transmitter is activated automatically. Such set-up information may include data.

The rationale for compliance with the above requirements was either test results or supplier declaration. The summary of results is provided in Table 7.1.1.

7.1.2 Test procedure for transmitter shut down test

7.1.2.1 The EUT was set up as shown in Figure 7.1.1 and associated photograph.

7.1.2.2 The spectrum analyzer center frequency was adjusted to the EUT carrier, span set to zero and video triggered for transmission.

7.1.2.3 The transmitter was activated either manually or automatically. Once manually operated transmitter was activated, the switch was immediately released.

7.1.2.4 The transmission time was captured and shown in Plot 7.1.1.

7.1.2.5 Upon this the test was completed.

7.1.3 Test procedure for measurements of polling / supervision transmission duration

7.1.3.1 The EUT was set up as shown in Figure 7.1.1 and associated photograph.

7.1.3.2 The spectrum analyzer center frequency was adjusted to the EUT carrier, span set to zero and video triggered for transmission.

7.1.3.3 The transmission time was captured and shown in Plot 7.1.2.

7.1.3.4 Upon this the test was completed.

Figure 7.1.1 Setup for transmitter shut down test





Test specification:	FCC Part 15, Section 231(a) / RSS-210, Section A1.1, Periodic operation requirements		
Test procedure:	Supplier declaration		
Test mode:	Compliance	Verdict: PASS	
Date(s):	07-Jul-20 - 23-Jul-20		
Temperature: 25.1 °C	Relative Humidity: 49 %	Air Pressure: 1005 hPa	Power: 120 VAC, 50 Hz
Remarks:			

Table 7.1.1 Periodic operation requirements

Requirement	Rationale	Verdict
Continuous transmissions are not permitted	Supplier declaration	Comply
A manually operated transmitter shall be deactivated within not more than 5 seconds of switch being released	Plot 7.1.1	Comply
Transmitter activated automatically shall cease transmission within 5 seconds	Plot 7.1.1	Comply
Periodic transmissions at regular predetermined intervals are not permitted	Supplier declaration	Comply
Total duration of polling or supervision transmissions shall not exceed 2 seconds per hour	Plot 7.1.2	Comply
Transmission of set-up information for security systems may exceed the transmission duration limits of 5 seconds, provided such transmissions are under the control of a professional installer and do not exceed ten seconds after a manually operated switch is released or a transmitter is activated automatically. Such set-up information may include data.	Supplier declaration	Comply

Table 7.1.2 Total duration of polling / supervision transmissions

Duration, ms	Repetition period, ms	Maximum number of transmissions within 1 hour	Total duration within 1 hour, ms
7.25	NA	3	21.75



Test specification:	FCC Part 15, Section 231(a) / RSS-210, Section A1.1, Periodic operation requirements		
Test procedure:	Supplier declaration		
Test mode:	Compliance	Verdict: PASS	
Date(s):	07-Jul-20 - 23-Jul-20		
Temperature: 25.1 °C	Relative Humidity: 49 %	Air Pressure: 1005 hPa	Power: 120 VAC, 50 Hz
Remarks:			

Plot 7.1.1 Transmitter shut down test result

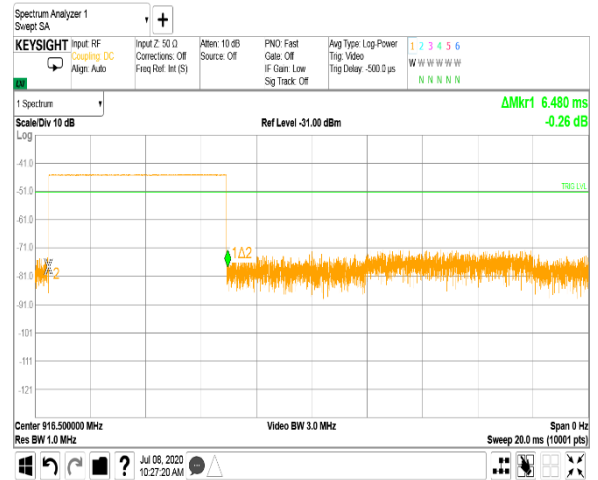
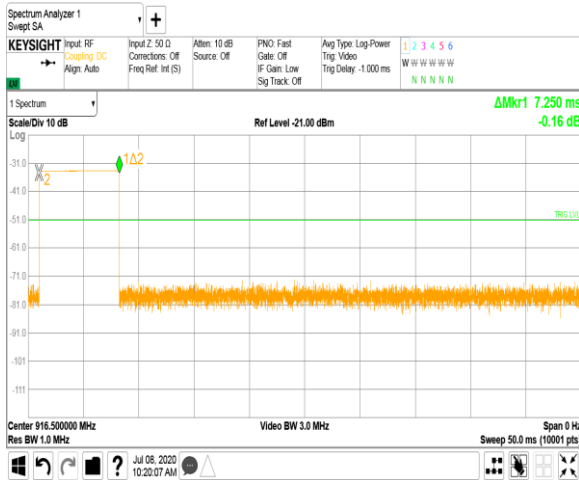

Plot 7.1.2 Polling / supervision transmission duration

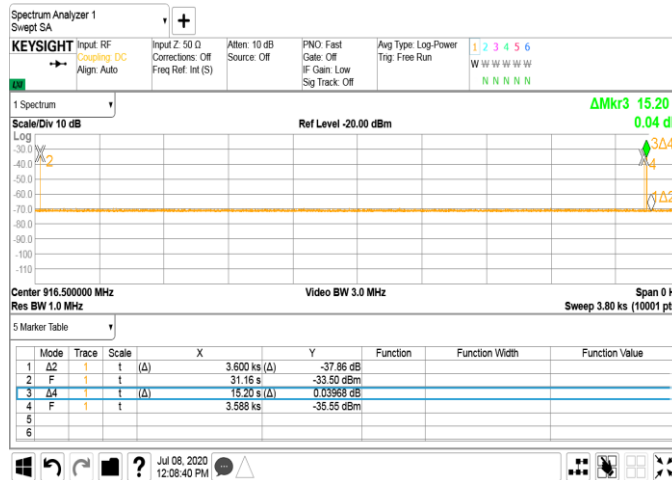

Reference numbers of test equipment used

HL 3901	HL 5376	HL 1809	HL 5397			
---------	---------	---------	---------	--	--	--

Full description is given in Appendix A.



Test specification:	FCC Part 15, Section 231(b) / RSS-210, Section A1.2, Field strength of emissions		
Test procedure:	ANSI C63.10 sections 6.5, 6.6		
Test mode:	Compliance	Verdict:	PASS
Date(s):	07-Jul-20 - 23-Jul-20		
Temperature: 28 °C	Relative Humidity: 51 %	Air Pressure: 1012 hPa	Power: 120 VAC, 50 Hz
Remarks:			

7.2 Field strength of emissions

7.2.1 General

This test was performed to measure field strength of fundamental and spurious emissions from the EUT. Specification test limits are given in Table 7.2.1 and Table 7.2.2.

Table 7.2.1 Radiated fundamental emission limits

Fundamental frequency, MHz	Field strength at 3 m, dB(μV/m)	
	Peak	Average
916.5	102.0	82.0

Table 7.2.2 Radiated spurious emissions limits

Frequency, MHz	Field strength at 3 m, dB(μV/m)				
	Within restricted bands			Outside restricted bands	
	Peak	Quasi Peak	Average	Peak	Average
0.009 – 0.090	148.5 – 128.5	NA	128.5 – 108.5**	82.0	62.0
0.090 – 0.110	NA	108.5 – 106.8**	NA		
0.110 – 0.490	126.8 – 113.8	NA	106.8 – 93.8**		
0.490 – 1.705	NA	73.8 – 63.0**	NA		
1.705 – 30.0*		69.5			
30 – 88		40.0			
88 – 216		43.5			
216 – 960		46.0			
960 - 1000		54.0			
Above 1000	74.0	NA	54.0		

*- The limit for 3 m test distance was calculated using the inverse square distance extrapolation factor as follows:

$$Lim_{S2} = Lim_{S1} + 40 \log (S_1/S_2),$$
 where S₁ and S₂ – standard defined and test distance respectively in meters.

** - The limit decreases linearly with the logarithm of frequency.

Note 1: The fundamental emission limit in dB(μV/m) was calculated as follows:

$$Lim_{AVR} = 20 \times \log(56.81818 \times F - 6136.3636) - \text{within } 130 - 174 \text{ MHz band;}$$

$$Lim_{AVR} = 20 \times \log(41.6667 \times F - 7083.3333) - \text{within } 260 - 470 \text{ MHz band,}$$

where F is the carrier frequency in MHz.

The limit for spurious emissions was 20 dB lower than fundamental emission limit.

The above limits provided in terms of average values, peak limit was 20 dB above the average limit.

Note 2: The above field strength limits applied from the lowest radio frequency generated in the device, without going below 9 kHz up to the tenth harmonic of the highest fundamental frequency.



Test specification:	FCC Part 15, Section 231(b) / RSS-210, Section A1.2, Field strength of emissions		
Test procedure:	ANSI C63.10 sections 6.5, 6.6		
Test mode:	Compliance	Verdict: PASS	
Date(s):	07-Jul-20 - 23-Jul-20		
Temperature: 28 °C	Relative Humidity: 51 %	Air Pressure: 1012 hPa	Power: 120 VAC, 50 Hz
Remarks:			

7.2.2 Test procedure for spurious emission field strength measurements in 9 kHz to 30 MHz band

7.2.2.1 The EUT was set up as shown in Figure 7.2.1, energized and the performance check was conducted.

7.2.2.2 The measurements were performed in two EUT orthogonal positions.

7.2.2.3 The specified frequency range was investigated with antenna connected to spectrum analyzer/EMI receiver. To find maximum radiation the turntable was rotated 360° and the measuring antenna was rotated around its vertical axis.

7.2.2.4 The worst test results (the lowest margins) found in the EUT vertical (X, Y, Z-axis) position were recorded in Table 7.2.3, Table 7.2.5 and shown in the associated plots.

7.2.3 Test procedure for spurious emission field strength measurements above 30 MHz

7.2.3.1 The EUT was set up as shown in Figure 7.2.2 / Figure 7.2.3, energized and the performance check was conducted.

7.2.3.2 The measurements were performed in two EUT orthogonal positions.

7.2.3.3 The specified frequency range was investigated with antenna connected to spectrum analyzer/EMI receiver. To find maximum radiation the turntable was rotated 360°, the measuring antenna height was changed from 1 to 4 m, its polarization was switched from vertical to horizontal.

7.2.3.4 The worst test results (the lowest margins) found in the EUT vertical (X, Y, Z-axis) position were recorded in Table 7.2.3, Table 7.2.5 and shown in the associated plots.

7.2.3.5 Upon this the test was completed.

Figure 7.2.1 Setup for spurious emission field strength measurements below 30 MHz

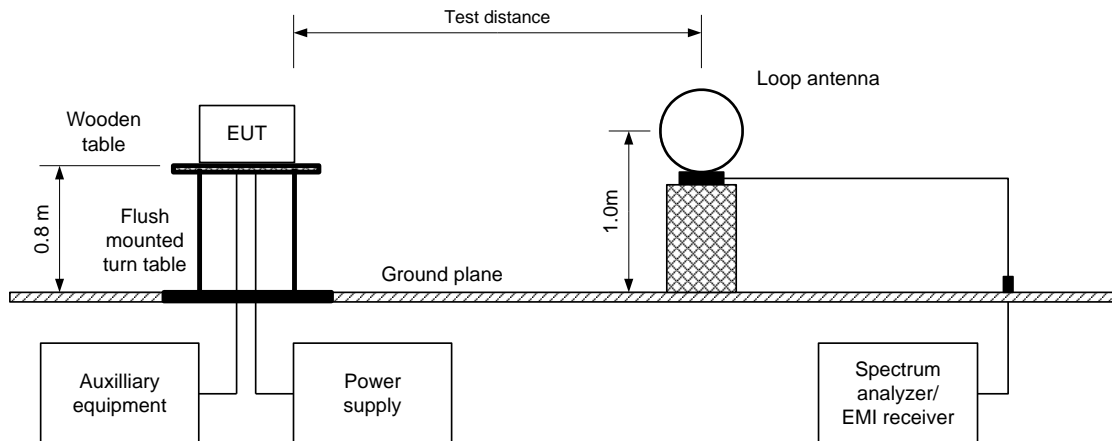



Test specification:	FCC Part 15, Section 231(b) / RSS-210, Section A1.2, Field strength of emissions		
Test procedure:	ANSI C63.10 sections 6.5, 6.6		
Test mode:	Compliance	Verdict: PASS	
Date(s):	07-Jul-20 - 23-Jul-20		
Temperature: 28 °C	Relative Humidity: 51 %	Air Pressure: 1012 hPa	Power: 120 VAC, 50 Hz
Remarks:			

Figure 7.2.2 Setup for spurious emission field strength measurements in 30 -1000 MHz

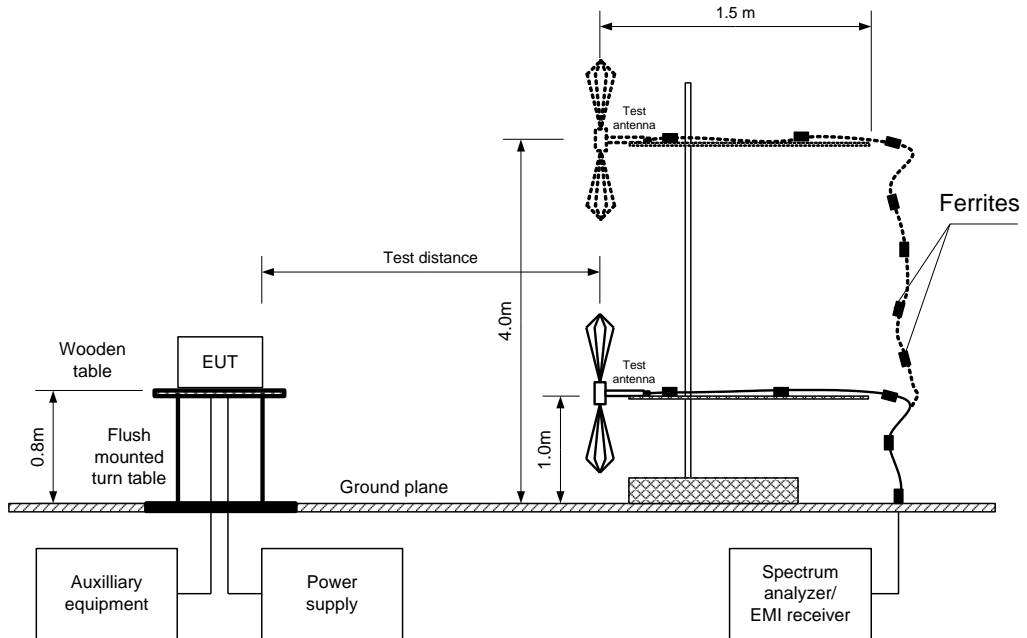
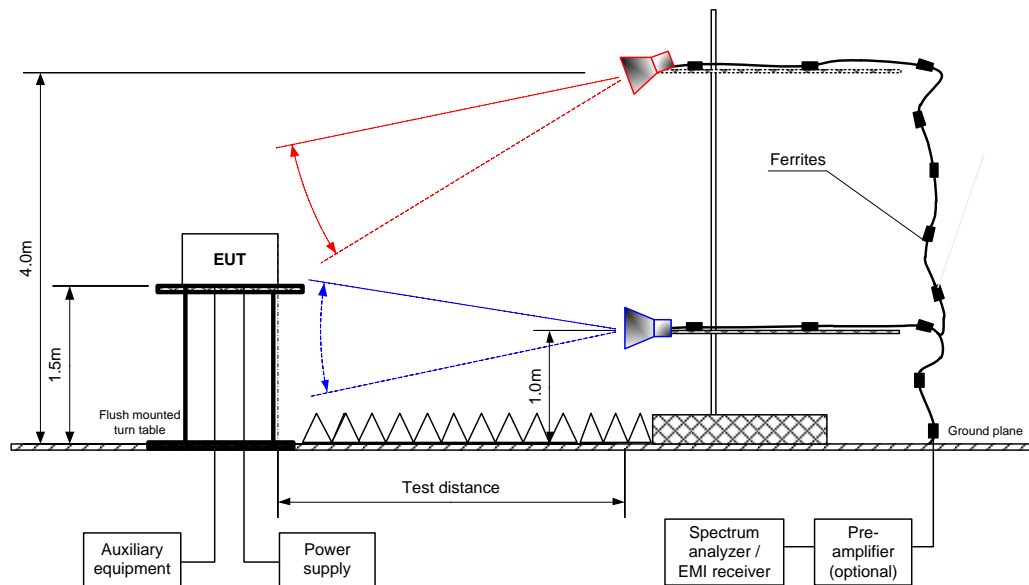

Figure 7.2.3 Setup for spurious emission field strength measurements above 1000 MHz





Test specification:	FCC Part 15, Section 231(b) / RSS-210, Section A1.2, Field strength of emissions		
Test procedure:	ANSI C63.10 sections 6.5, 6.6		
Test mode:	Compliance	Verdict:	PASS
Date(s):	07-Jul-20 - 23-Jul-20		
Temperature: 28 °C	Relative Humidity: 51 %	Air Pressure: 1012 hPa	Power: 120 VAC, 50 Hz
Remarks:			

Table 7.2.3 Field strength of fundamental emission, spurious emissions outside restricted bands and within restricted bands at frequencies above 1 GHz

TEST DISTANCE: 3 m
 EUT POSITION: Typical (Vertical)
 MODULATION: 2FSK
 MODULATING SIGNAL: PRBS
 BIT RATE: 38.4 kbps
 TRANSMITTER OUTPUT POWER SETTINGS: Maximum
 INVESTIGATED FREQUENCY RANGE: 0.009 -10000MHz
 DETECTOR USED: Peak
 RESOLUTION BANDWIDTH: 0.2 kHz (9 kHz – 150 kHz)
 9.0 kHz (150 kHz – 30 MHz)
 120 kHz (30 MHz – 1000 MHz)
 1.0 MHz (above 1000 MHz)
 VIDEO BANDWIDTH: ≥ Resolution bandwidth
 TEST ANTENNA TYPE: Active loop (9 kHz – 30 MHz)
 Biconilog (30 MHz – 1000 MHz)
 Double ridged guide (above 1000 MHz)

F, MHz	Antenna		Azimuth, degrees*	Peak field strength			Average field strength				Verdict
	Pol.	Height, m		Measured, dB(μV/m)	Limit, dB(μV/m)	Margin, dB**	Measured, dB(μV/m)	Calculated, dB(μV/m)	Limit, dB(μV/m)	Margin, dB**	
Fundamental emission***											
916.5	V	1.32	-180.0	101.34	102.0	-0.66	101.34	78.588	82.0	-3.412	Pass
Spurious emissions											Pass
No emissions were found											

*- EUT front panel refers to 0 degrees position of turntable.

**- Margin, dB =Measured (calculated) value, dB(μV/m)-Limit, dB(μV/m)

*** Max value was obtained in X (Y, Z)-axis orthogonal position and at Unom (115%Unom, 85%Unom) input power voltage.

Table 7.2.4 Average factor calculation

Transmission pulse		Transmission burst		Transmission train duration, ms	Average factor, dB
Duration, ms	Number pulse during 100 msec	Duration, ms	Period, ms		
7.28443	100	NA	NA	NA	-22.752

Average factor for pulse train shorter than 100 ms was calculated as follows:

$$Average\ factor = 20 \times \log_{10} \left(\frac{Pulse\ duration}{Pulse\ period} \times \frac{Burst\ duration}{Train\ duration} \times Number\ of\ bursts\ within\ pulse\ train \right)$$

Average factor for pulse train longer than 100 ms was calculated as follows:

$$Average\ factor = 20 \times \log_{10} \left(\frac{Pulse\ duration}{Pulse\ period} \times \frac{Burst\ duration}{100ms} \times Number\ of\ bursts\ within\ 100ms \right)$$

Reference numbers of test equipment used

HL 5665	HL 446	HL 3903	HL 4360	HL 4933	HL 5085	HL 5288	HL 4339
HL 4011							

Full description is given in Appendix A.



Test specification:	FCC Part 15, Section 231(b) / RSS-210, Section A1.2, Field strength of emissions		
Test procedure:	ANSI C63.10 sections 6.5, 6.6		
Test mode:	Compliance	Verdict: PASS	
Date(s):	07-Jul-20 - 23-Jul-20		
Temperature: 28 °C	Relative Humidity: 51 %	Air Pressure: 1012 hPa	Power: 120 VAC, 50 Hz
Remarks:			

Table 7.2.5 Field strength of emissions below 1 GHz within restricted bands

TEST DISTANCE:	3 m
EUT POSITION:	Typical (Vertical)
MODULATION:	2FSK
MODULATING SIGNAL:	PRBS
BIT RATE:	38.4 kbps
TRANSMITTER OUTPUT POWER SETTINGS:	Maximum
INVESTIGATED FREQUENCY RANGE:	0.009 – 1000 MHz
DETECTOR USED:	Peak
RESOLUTION BANDWIDTH:	0.2 kHz (9 kHz – 150 kHz) 9.0 kHz (150 kHz – 30 MHz) 120 kHz (30 MHz – 1000 MHz)
VIDEO BANDWIDTH:	≥ Resolution bandwidth
TEST ANTENNA TYPE:	Active loop (9 kHz – 30 MHz) Biconilog (30 MHz – 1000 MHz)
CASE SELECTION:	Worst case measurements

Frequency, MHz	Peak emission, dB(μV/m)	Quasi-peak			Antenna polarization	Antenna height, m	Turn-table position**, degrees	Verdict
		Measured emission, dB(μV/m)	Limit, dB(μV/m)	Margin, dB*				
71.827	28.57	21.95	40.0	-18.05	Vertical	1.04	56.0	Pass
118.952	31.77	24.53	43.5	-18.97	Vertical	1.02	-59.0	
120.206	25.09	16.63	43.5	-26.87	Vertical	1.02	-55.0	
964.488	42.90	40.38	54.0	-13.62	Vertical	1.75	45.0	
964.514	41.23	38.07	54.0	-15.93	Horizontal	1.02	180.0	

*- Margin = Measured emission - specification limit.

**- EUT front panel refer to 0 degrees position of turntable.



Test specification:	FCC Part 15, Section 231(b) / RSS-210, Section A1.2, Field strength of emissions			
Test procedure:	ANSI C63.10 sections 6.5, 6.6			
Test mode:	Compliance	Verdict:		PASS
Date(s):	07-Jul-20 - 23-Jul-20			
Temperature: 28 °C	Relative Humidity: 51 %	Air Pressure: 1012 hPa	Power: 120 VAC, 50 Hz	
Remarks:				

Table 7.2.6 Restricted bands

MHz	MHz	MHz	MHz	MHz	GHz
0.09 - 0.11	8.37625 - 8.38675	73 - 74.6	399.9 - 410	2690 - 2900	10.6 - 12.7
0.495 - 0.505	8.41425 - 8.41475	74.8 - 75.2	608 - 614	3260 - 3267	13.25 - 13.4
2.1735 - 2.1905	12.29 - 12.293	108 - 121.94	960 - 1240	3332 - 3339	14.47 - 14.5
4.125 - 4.128	12.51975 - 12.52025	123 - 138	1300 - 1427	3345.8 - 3358	15.35 - 16.2
4.17725 - 4.17775	12.57675 - 12.57725	149.9 - 150.05	1435 - 1626.5	3600 - 4400	17.7 - 21.4
4.20725 - 4.20775	13.36 - 13.41	156.52475 - 156.52525	1645.5 - 1646.5	4500 - 5150	22.01 - 23.12
6.215 - 6.218	16.42 - 16.423	156.7 - 156.9	1660 - 1710	5350 - 5460	23.6 - 24
6.26775 - 6.26825	16.69475 - 16.69525	162.0125 - 167.17	1718.8 - 1722.2	7250 - 7750	31.2 - 31.8
6.31175 - 6.31225	16.80425 - 16.80475	167.72 - 173.2	2200 - 2300	8025 - 8500	36.43 - 36.5
8.291 - 8.294	25.5 - 25.67	240 - 285	2310 - 2390	9000 - 9200	Above 38.6
8.362 - 8.366	37.5 - 38.25	322 - 335.4	2483.5 - 2500	9300 - 9500	

Table 7.2.7 Restricted bands according to RSS-Gen, Table 3

MHz	MHz	MHz	MHz	MHz	GHz
0.09 - 0.11	8.291 - 8.294	16.80425 - 16.80475	399.9 - 410	3260 - 3267	10.6 - 12.7
2.1735 - 2.190	8.362 - 8.366	25.5 - 25.67	608 - 614	3332 - 3339	13.25 - 13.4
3.020 - 3.026	8.37625 - 8.38675	37.5 - 38.25	960 - 1427	3345.8 - 3358	14.47 - 14.5
4.125 - 4.128	8.41425 - 8.41475	73 - 74.6	1435 - 1626.5	3500 - 4400	15.35 - 16.2
4.17725 - 4.17775	12.290 - 12.293	74.8 - 75.2	1645.5 - 1646.5	4500 - 5150	17.7 - 21.4
4.20725 - 4.20775	12.51975 - 12.52025	108 - 138	1660 - 1710	5350 - 5460	22.01 - 23.12
5.677 - 5.683	12.57675 - 12.57725	156.52475 - 156.52525	1718.8 - 1722.2	7250 - 7750	23.6 - 24.0
6.215 - 6.218	13.36 - 13.41	156.7 - 156.9	2200 - 2300	8025 - 8500	31.2 - 31.8
6.26775 - 6.26825	16.42 - 16.423	240 - 285	2310 - 2390	9000 - 9200	36.43 - 36.5
6.31175 - 6.31225	16.69475 - 16.69525	322 - 335.4	2655 - 2900	9300 - 9500	Above 38.6



Test specification:	FCC Part 15, Section 231(b) / RSS-210, Section A1.2, Field strength of emissions		
Test procedure:	ANSI C63.10 sections 6.5, 6.6		
Test mode:	Compliance	Verdict: PASS	
Date(s):	07-Jul-20 - 23-Jul-20		
Temperature: 28 °C	Relative Humidity: 51 %	Air Pressure: 1012 hPa	Power: 120 VAC, 50 Hz
Remarks:			

Plot 7.2.1 Radiated emission measurements at the fundamental frequency

TEST SITE: Semi anechoic chamber
 TEST DISTANCE: 3 m
 ANTENNA POLARIZATION: Vertical and Horizontal
 EUT POSITION: Typical
 INPUT VOLTAGE: Unom 120VAC AC adaptor ac to dc 9VDC PSU

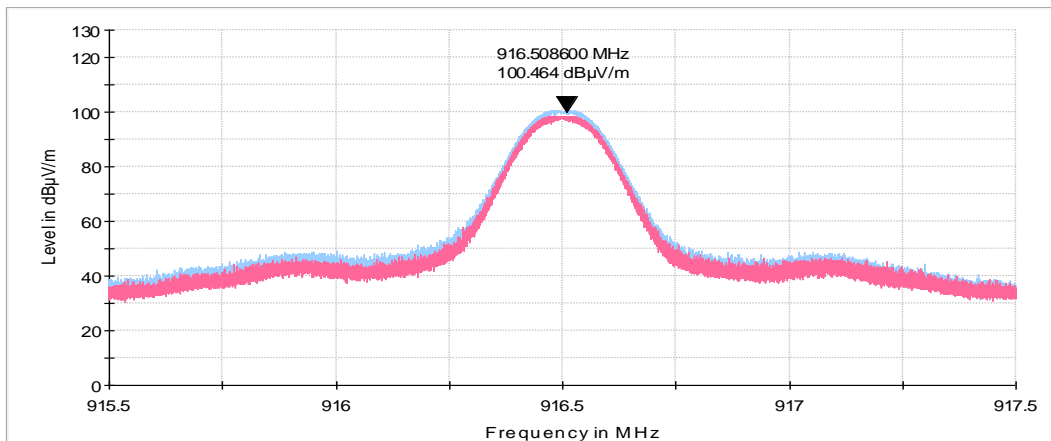

Plot 7.2.2 Radiated emission measurements at the fundamental frequency

TEST SITE: Semi anechoic chamber
 TEST DISTANCE: 3 m
 ANTENNA POLARIZATION: Vertical
 EUT POSITION: Typical
 INPUT VOLTAGE: 115%Unom 138VAC AC adaptor ac to dc 9VDC PSU

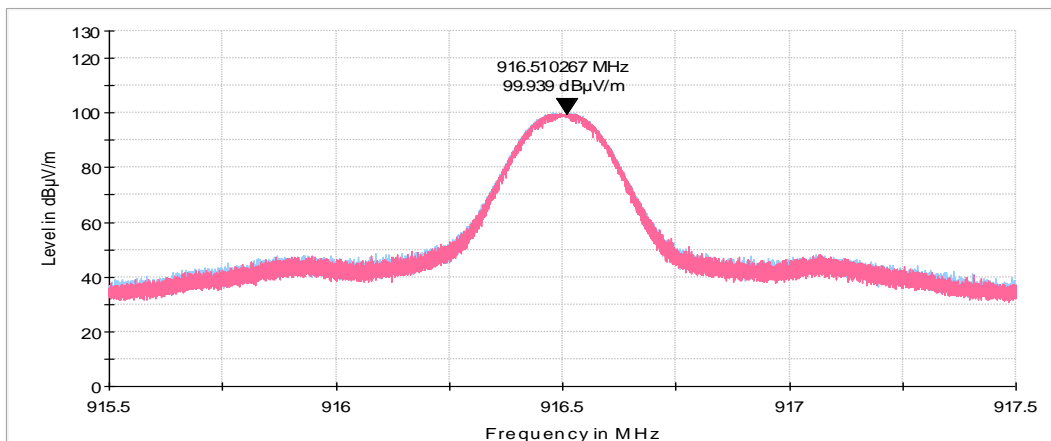



Test specification:	FCC Part 15, Section 231(b) / RSS-210, Section A1.2, Field strength of emissions		
Test procedure:	ANSI C63.10 sections 6.5, 6.6		
Test mode:	Compliance	Verdict:	PASS
Date(s):	07-Jul-20 - 23-Jul-20		
Temperature: 28 °C	Relative Humidity: 51 %	Air Pressure: 1012 hPa	Power: 120 VAC, 50 Hz
Remarks:			

Plot 7.2.3 Radiated emission measurements at the fundamental frequency

TEST SITE: Semi anechoic chamber
TEST DISTANCE: 3 m
ANTENNA POLARIZATION: Vertical and Horizontal
EUT POSITION: Typical
INPUT VOLTAGE: 85%Unom 102VAC AC adaptor ac to dc 9VDC PSU

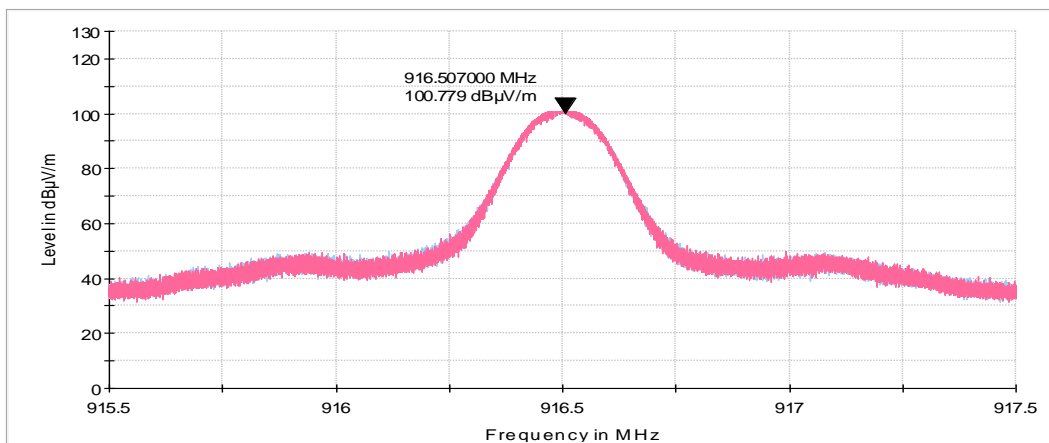



Test specification:	FCC Part 15, Section 231(b) / RSS-210, Section A1.2, Field strength of emissions		
Test procedure:	ANSI C63.10 sections 6.5, 6.6		
Test mode:	Compliance	Verdict: PASS	
Date(s):	07-Jul-20 - 23-Jul-20		
Temperature: 28 °C	Relative Humidity: 51 %	Air Pressure: 1012 hPa	Power: 120 VAC, 50 Hz
Remarks:			

Plot 7.2.4 Radiated emission measurements from 9 kHz to 30 MHz

TEST SITE: Semi anechoic chamber
 TEST DISTANCE: 3 m
 ANTENNA POLARIZATION: Vertical and Horizontal
 EUT POSITION: Typical
 INPUT VOLTAGE: Unom 120VAC AC adaptor ac to dc 9VDC PSU

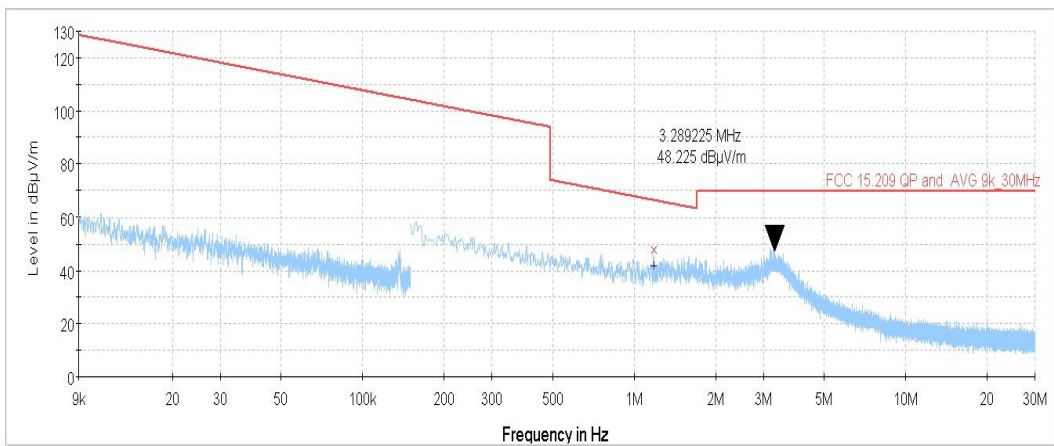

Plot 7.2.5 Radiated emission measurements from 30 to 1000 MHz

TEST SITE: Semi anechoic chamber
 TEST DISTANCE: 3 m
 ANTENNA POLARIZATION: Vertical and Horizontal
 EUT POSITION: Typical
 INPUT VOLTAGE: Unom 120VAC AC adaptor ac to dc 9VDC PSU

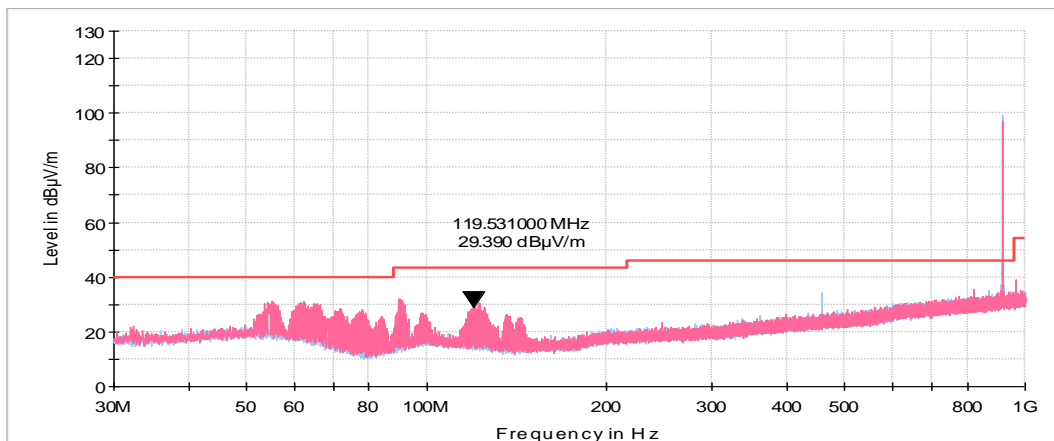



Test specification:	FCC Part 15, Section 231(b) / RSS-210, Section A1.2, Field strength of emissions		
Test procedure:	ANSI C63.10 sections 6.5, 6.6		
Test mode:	Compliance	Verdict: PASS	
Date(s):	07-Jul-20 - 23-Jul-20		
Temperature: 28 °C	Relative Humidity: 51 %	Air Pressure: 1012 hPa	Power: 120 VAC, 50 Hz
Remarks:			

Plot 7.2.6 Radiated emission measurements from 1000 to 10000 MHz

TEST SITE: Semi anechoic chamber
 TEST DISTANCE: 3 m
 ANTENNA POLARIZATION: Vertical and Horizontal
 EUT POSITION: Typical
 INPUT VOLTAGE: Unom 120VAC AC adaptor ac to dc 9VDC PSU

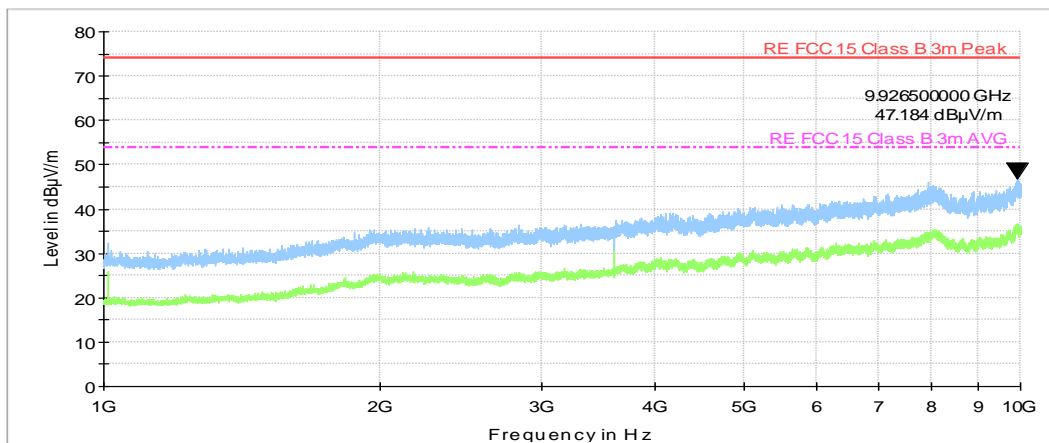



Test specification:	FCC Part 15, Section 231(b) / RSS-210, Section A1.2, Field strength of emissions		
Test procedure:	ANSI C63.10 sections 6.5, 6.6		
Test mode:	Compliance	Verdict: PASS	
Date(s):	07-Jul-20 - 23-Jul-20		
Temperature: 28 °C	Relative Humidity: 51 %	Air Pressure: 1012 hPa	Power: 120 VAC, 50 Hz
Remarks:			

Plot 7.2.7 Transmission pulse duration

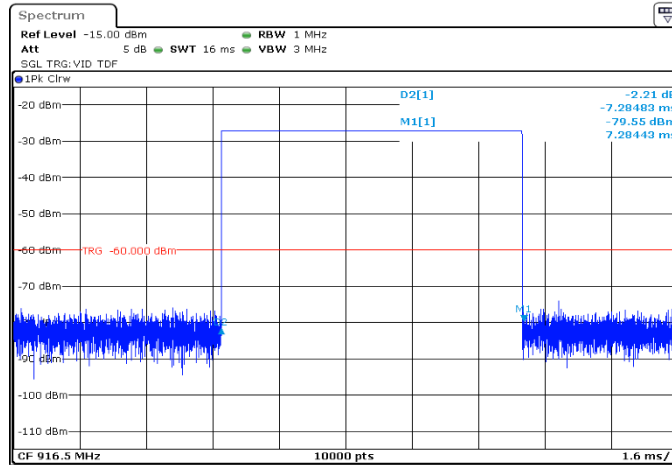

Plot 7.2.8 Transmission pulse period

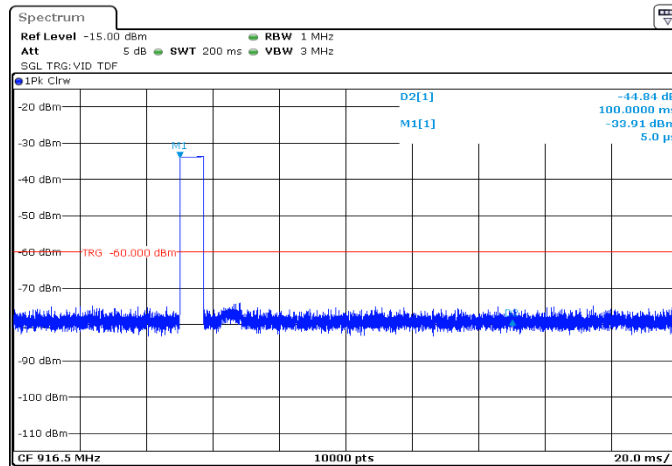



Test specification:	FCC Part 15, Section 231(c) / RSS-210, Section A1.3, Occupied bandwidth		
Test procedure:	ANSI C63.10 section 6.9.2		
Test mode:	Compliance	Verdict: PASS	
Date(s):	08-Jul-20		
Temperature: 25.2 °C	Relative Humidity: 46 %	Air Pressure: 1024 hPa	Power: 120 VAC, 50 Hz
Remarks:			

7.3 Occupied bandwidth test

7.3.1 General

This test was performed to measure transmitter occupied bandwidth. Specification test limits are given in Table 7.3.1. The test results are provided in Table 7.3.2 and associated plots.

Table 7.3.1 Occupied bandwidth limits

Assigned frequency, MHz	Modulation envelope reference points*, dBc	Maximum allowed bandwidth, % of the carrier frequency
70 - 900	20.0	0.25
Above 900		0.50

*- Modulation envelope reference points provided in terms of attenuation below modulated carrier.

7.3.2 Test procedure

7.3.2.1 The EUT was set up as shown in Figure 7.3.1, energized and its proper operation was checked.

7.3.2.2 The EUT was set to transmit modulated carrier.

7.3.2.3 The transmitter occupied bandwidth was measured with spectrum analyzer as frequency delta between reference points on modulation envelope and provided in Table 7.3.2 and associated plot.

Figure 7.3.1 Occupied bandwidth test setup





Test specification:	FCC Part 15, Section 231(c) / RSS-210, Section A1.3, Occupied bandwidth		
Test procedure:	ANSI C63.10 section 6.9.2		
Test mode:	Compliance	Verdict: PASS	
Date(s):	08-Jul-20		
Temperature: 25.2 °C	Relative Humidity: 46 %	Air Pressure: 1024 hPa	Power: 120 VAC, 50 Hz
Remarks:			

Table 7.3.2 Occupied bandwidth test results

DETECTOR USED: Peak hold
 RESOLUTION BANDWIDTH: 2kHz
 VIDEO BANDWIDTH: 6kHz
 MODULATION ENVELOPE REFERENCE POINTS: 20 dBc
 MODULATION: 2FSK
 BIT RATE: 38.4kbps

Carrier frequency, MHz	Occupied bandwidth, kHz	Limit		Margin, kHz	Verdict
		% of the carrier frequency	kHz		
916.5	74.43	0.5	4582.5	-4507.57	Pass

Table 7.3.3 Occupied bandwidth test results

DETECTOR USED: Peak hold
 RESOLUTION BANDWIDTH: 2kHz
 VIDEO BANDWIDTH: 6kHz
 MODULATION ENVELOPE REFERENCE POINTS: 99 %
 MODULATION: 2FSK
 BIT RATE: 38.4kbps

Carrier frequency, MHz	Occupied bandwidth, kHz	Limit		Margin, kHz	Verdict
		% of the carrier frequency	kHz		
916.5	78.76	0.5	4582.5	-4503.74	Pass

Reference numbers of test equipment used

HL 3901	HL 4136	HL 5397						
---------	---------	---------	--	--	--	--	--	--

Full description is given in Appendix A.

Plot 7.3.1 Occupied bandwidth test results

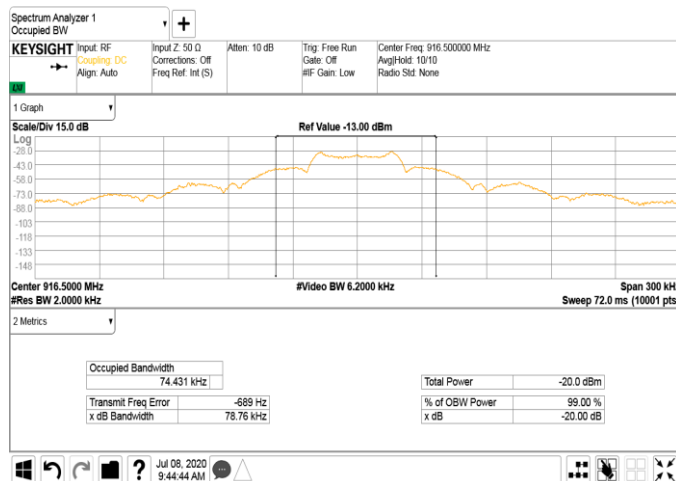

Test specification:	FCC Part 15, Section 207 / RSS-Gen, Section 8.8, Conducted emission		
Test procedure:	ANSI C63.10 section 6.2		
Test mode:	Compliance	Verdict: PASS	
Date(s):	08-Jul-20		
Temperature: 24 °C	Relative Humidity: 50 %	Air Pressure: 1024 hPa	Power: 120 VAC, 50 Hz
Remarks:			

7.4 Conducted emissions

7.4.1 General

This test was performed to measure common mode conducted emissions at the mains power port. Specification test limits are given in Table 7.4.1. The worst test results (the lowest margins) were recorded in Table 7.4.2 and shown in the associated plots.

Table 7.4.1 Limits for conducted emissions according to FCC Part 15, Section 207 / RSS-Gen, Section 7.2.2

Frequency, MHz	Class B limit, dB(μV)		Class A limit, dB(μV)	
	QP	AVRG	QP	AVRG
0.15 - 0.5	66 - 56*	56 - 46*	79	66
0.5 - 5.0	56	46	73	60
5.0 - 30	60	50	73	60

* The limit decreases linearly with the logarithm of frequency.

7.4.2 Test procedure

7.4.2.1 The EUT was set up as shown in Figure 7.4.1 and associated photographs, energized and the performance check was conducted.

7.4.2.2 The measurements were performed at power terminals with the LISN, connected to a spectrum analyzer in the frequency range referred to in Table 7.4.2. Unused coaxial connector of the LISN was terminated with 50 Ohm. Quasi-peak and Average detectors were used for the testing.

7.4.2.3 The position of the device cables was varied to determine maximum emission level.

Figure 7.4.1 Setup for conducted emission measurements

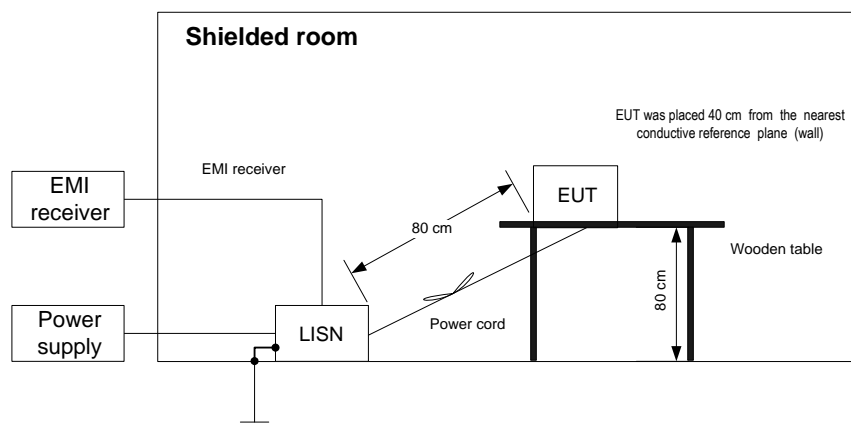



Test specification:	FCC Part 15, Section 207 / RSS-Gen, Section 8.8, Conducted emission		
Test procedure:	ANSI C63.10 section 6.2		
Test mode:	Compliance	Verdict: PASS	
Date(s):	08-Jul-20		
Temperature: 24 °C	Relative Humidity: 50 %	Air Pressure: 1024 hPa	Power: 120 VAC, 50 Hz
Remarks:			

Table 7.4.2 Conducted emission test results

LINE: AC mains
EUT OPERATING MODE: Transmit
EUT SET UP: TABLE-TOP
TEST SITE: SHIELDED ROOM
DETECTORS USED: PEAK / QUASI-PEAK / AVERAGE
FREQUENCY RANGE: 150 kHz - 30 MHz
RESOLUTION BANDWIDTH: 9 kHz

Frequency, MHz	Peak emission, dB(µV)	Quasi-peak			Average			Line ID	Verdict
		Measured emission, dB(µV)	Limit, dB(µV)	Margin, dB*	Measured emission, dB(µV)	Limit, dB(µV)	Margin, dB*		
All emission were found 20dB below the limit								L1	Pass
All emission were found 20dB below the limit								L2	Pass

*- Margin = Measured emission - specification limit.

Reference numbers of test equipment used

HL 3016	HL 5700	HL 5601	HL 4528	HL 5476	HL 2382		
---------	---------	---------	---------	---------	---------	--	--

Full description is given in Appendix A.



HERMON LABORATORIES

Test specification:	FCC Part 15, Section 207 / RSS-Gen, Section 8.8, Conducted emission		
Test procedure:	ANSI C63.10 section 6.2		
Test mode:	Compliance	Verdict: PASS	
Date(s):	08-Jul-20		
Temperature: 24 °C	Relative Humidity: 50 %	Air Pressure: 1024 hPa	Power: 120 VAC, 50 Hz
Remarks:			

Plot 7.4.1 Conducted emission measurements

LINE: L1
LIMIT: Class B
EUT OPERATING MODE: Transmit
LIMIT: QUASI-PEAK, AVERAGE
DETECTOR: PEAK

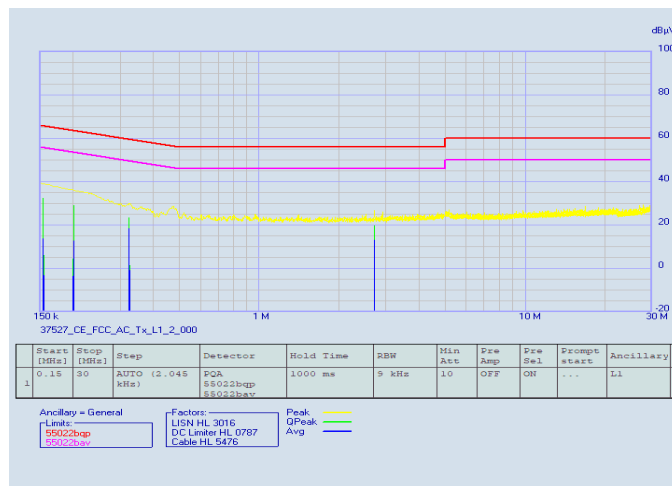

Plot 7.4.2 Conducted emission measurements

LINE: L2
LIMIT: Class B
EUT OPERATING MODE: Transmit
LIMIT: QUASI-PEAK, AVERAGE
DETECTOR: PEAK

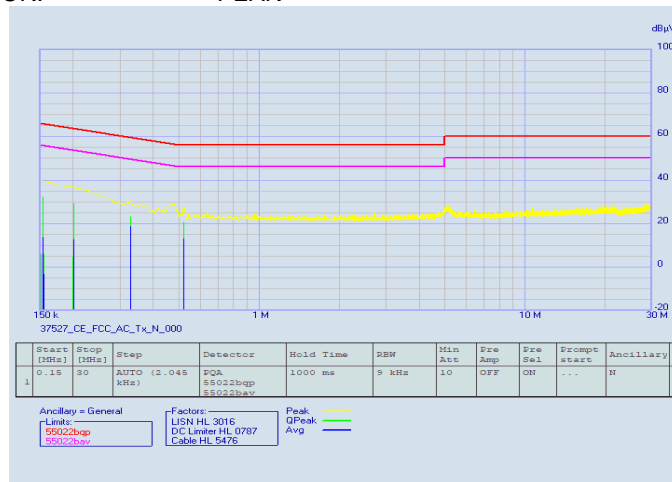



Test specification:	FCC Part 15, Section 203 / RSS-Gen, Section 6.8, Antenna requirements		
Test procedure:	Visual inspection / supplier declaration		
Test mode:	Compliance	Verdict:	PASS
Date(s):	08-Jul-20		
Temperature: 23 °C	Relative Humidity: 55 %	Air Pressure: 1009 hPa	Power: NA
Remarks:			

7.5 Antenna requirements

The EUT was verified for compliance with antenna requirements. A transmitter shall be designed to ensure that no antenna other than that furnished by the responsible party will be used with the device. It may be either permanently attached or employs a unique antenna connector for every antenna proposed for use with the EUT. This requirement does not apply to professionally installed transmitters.

The rationale for compliance with the above requirements was either visual inspection results or supplier declaration. The summary of results is provided in Table 7.4.1.

Table 7.4.1 Antenna requirements

Requirement	Rationale	Verdict
The transmitter antenna is permanently attached	Visual inspection	Comply
The transmitter employs a unique antenna connector	NA	
The transmitter requires professional installation	NA	

Photograph 7.5.1 Antenna assembly

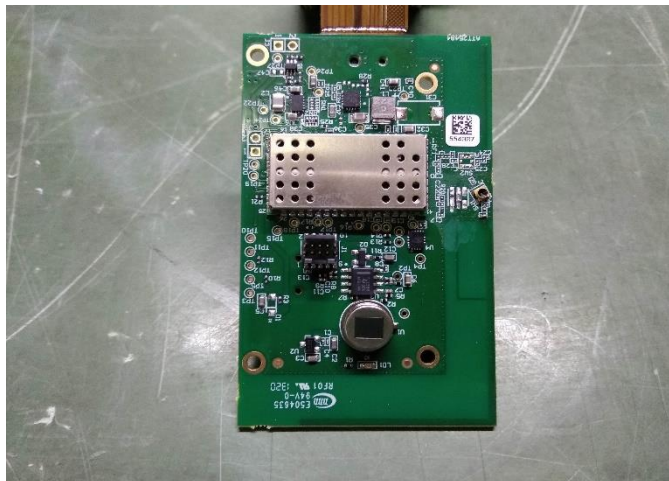

Test specification:	FCC Part 15, Section 107 / ICES-003, Section 6.1, Class B, Conducted emission at AC power port		
Test procedure:	ANSI C63.4, Section 7.3 and 12.2.4		
Test mode:	Compliance	Verdict: PASS	
Date(s):	08-Jul-20		
Temperature: 24 °C	Relative Humidity: 50 %	Air Pressure: 1015 hPa	Power: 120 VAC, 50 Hz
Remarks:			

8 Emissions tests according to FCC 47CFR part 15 subpart B and ICES-003 requirements

8.1 Conducted emissions

8.1.1 General

This test was performed to measure common mode conducted emissions at the mains power port. Specification test limits are given in Table 8.1.1. The worst test results (the lowest margins) were recorded in Table 8.1.2 and shown in the associated plots.

Table 8.1.1 Limits for conducted emissions

Frequency, MHz	Class B limit, dB(μ V)		Class A limit, dB(μ V)	
	QP	AVRG	QP	AVRG
0.15 - 0.5	66 - 56*	56 - 46*	79	66
0.5 - 5.0	56	46	73	60
5.0 - 30	60	50	73	60

* The limit decreases linearly with the logarithm of frequency.

8.1.2 Test procedure

8.1.2.1 The EUT was set up as shown in Figure 8.1.1 and associated photographs, energized and the performance check was conducted.

8.1.2.2 The measurements were performed at power terminals with the LISN, connected to a spectrum analyzer in the frequency range referred to in Table 8.1.2. Unused coaxial connector of the LISN was terminated with 50 Ohm. Quasi-peak and Average detectors were used for the testing.

8.1.2.3 The position of the device cables was varied to determine maximum emission level.

8.1.2.4 The worst test results (the lowest margins) were recorded in Table 8.1.2 and shown in the associated plots.

Figure 8.1.1 Setup for conducted emission measurements

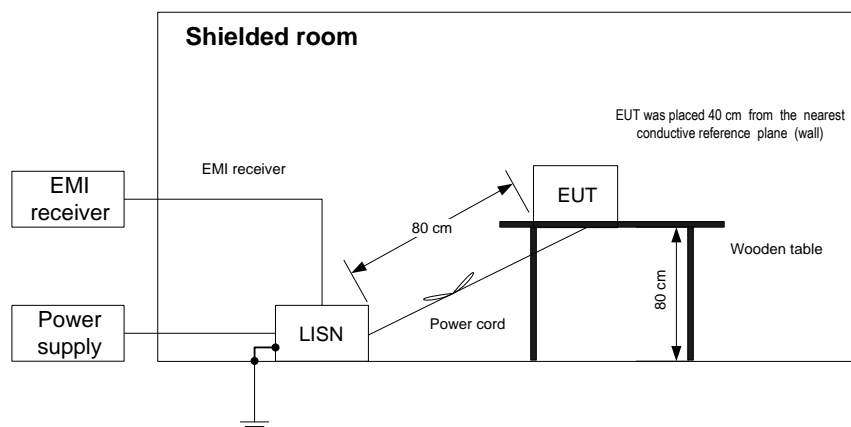



Test specification:	FCC Part 15, Section 107 / ICES-003, Section 6.1, Class B, Conducted emission at AC power port		
Test procedure:	ANSI C63.4, Section 7.3 and 12.2.4		
Test mode:	Compliance	Verdict: PASS	
Date(s):	08-Jul-20		
Temperature: 24 °C	Relative Humidity: 50 %	Air Pressure: 1015 hPa	Power: 120 VAC, 50 Hz
Remarks:			

Table 8.1.2 Conducted emission test results

LINE: AC mains
 EUT OPERATING MODE: Stand-by and receive
 EUT SET UP: TABLE-TOP
 TEST SITE: SHIELDED ROOM
 DETECTORS USED: PEAK / QUASI-PEAK / AVERAGE
 FREQUENCY RANGE: 150 kHz - 30 MHz
 RESOLUTION BANDWIDTH: 9 kHz

Frequency, MHz	Peak emission, dB(µV)	Quasi-peak			Average			Line ID	Verdict
		Measured emission, dB(µV)	Limit, dB(µV)	Margin, dB*	Measured emission, dB(µV)	Limit, dB(µV)	Margin, dB*		
All emission were found 20dB below the limit								L1	Pass
All emission were found 20dB below the limit								L2	Pass

*- Margin = Measured emission - specification limit.

Reference numbers of test equipment used

HL 3016	HL 5700	HL 5601	HL 4528	HL 5476	HL 2382		
---------	---------	---------	---------	---------	---------	--	--

Full description is given in Appendix A.



Test specification:	FCC Part 15, Section 107 / ICES-003, Section 6.1, Class B, Conducted emission at AC power port		
Test procedure:	ANSI C63.4, Section 7.3 and 12.2.4		
Test mode:	Compliance	Verdict: PASS	
Date(s):	08-Jul-20		
Temperature: 24 °C	Relative Humidity: 50 %	Air Pressure: 1015 hPa	Power: 120 VAC, 50 Hz
Remarks:			

Plot 8.1.1 Conducted emission measurements

LINE: L1
 LIMIT: Class B
 EUT OPERATING MODE: Stand-by and receive
 LIMIT: QUASI-PEAK, AVERAGE
 DETECTOR: PEAK

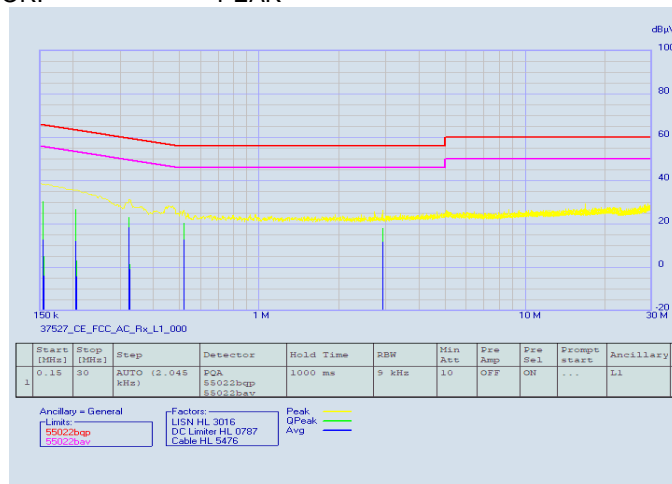

Plot 8.1.2 Conducted emission measurements

LINE: L2
 LIMIT: Class B
 EUT OPERATING MODE: Stand-by and receive
 LIMIT: QUASI-PEAK, AVERAGE
 DETECTOR: PEAK

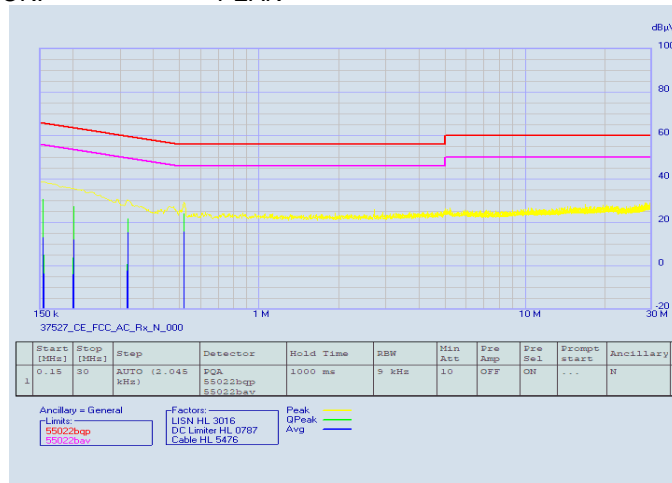



Test specification:	FCC Part 15, Section 109 / RSS-Gen, Section 7.3 / ICES-003, Radiated emission		
Test procedure:	ANSI C63.4, Sections 8.3 and 12.2.5		
Test mode:	Compliance	Verdict:	PASS
Date(s):	07-Jul-20		
Temperature: 23 °C	Relative Humidity: 55 %	Air Pressure: 1012 hPa	Power: 120 VAC, 50 Hz
Remarks:			

8.2 Radiated emission measurements

8.2.1 General

This test was performed to measure radiated emissions from the EUT enclosure. Specification test limits are given in Table 8.2.1.

Table 8.2.1 Radiated emission test limits

Frequency, MHz	Class B limit, dB(μV/m)		Class A limit, dB(μV/m)	
	10 m distance	3 m distance	10 m distance	3 m distance
30 - 88	29.5*	40.0	39.0	49.5*
88 - 216	33.0*	43.5	43.5	54.0*
216 - 960	35.5*	46.0	46.4	56.9*
Above 960	43.5*	54.0	49.5	60.0*

* The limit for test distance other than specified was calculated using the inverse linear distance extrapolation factor as follows: $Lims_2 = Lims_1 + 20 \log(S_1/S_2)$, where S_1 and S_2 – standard defined and test distance respectively in meters.

Table 8.2.2 Radiated emission limits according to RSS-Gen, Section 7.1.2

Frequency, MHz	Field strength limit at 3 m test distance, dB(μV/m)
30 - 88	40.0
88 - 216	43.5
216 - 960	46.0
960 - 5 th harmonic**	54.0

** - harmonic of the highest frequency the EUT generates, uses, operates or tunes to.

8.2.2 Test procedure

8.2.2.1 The EUT was set up as shown in Figure 8.2.1 and associated photograph, energized and the performance check was conducted.

8.2.2.2 The specified frequency range was investigated with biconilog antenna connected to EMI receiver. To find maximum radiation the turntable was rotated 360°, the measuring antenna height was changed from 1 to 4 m, its polarization was switched from vertical to horizontal and the EUT cables position was varied.

8.2.2.3 The worst test results (the lowest margins) were recorded in Table 8.2.3, and shown in the associated plots.



Test specification:	FCC Part 15, Section 109 / RSS-Gen, Section 7.3 / ICES-003, Radiated emission		
Test procedure:	ANSI C63.4, Sections 8.3 and 12.2.5		
Test mode:	Compliance	Verdict:	PASS
Date(s):	07-Jul-20		
Temperature: 23 °C	Relative Humidity: 55 %	Air Pressure: 1012 hPa	Power: 120 VAC, 50 Hz
Remarks:			

Figure 8.2.1 Setup for radiated emission measurements

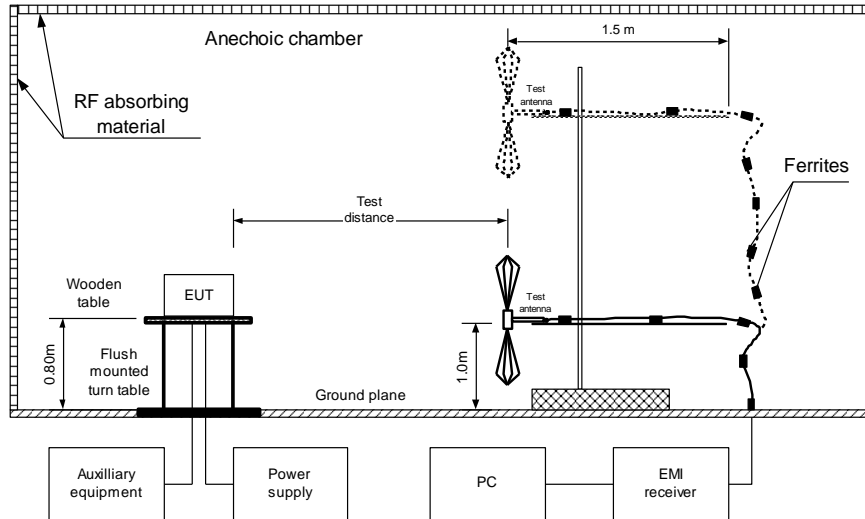



Test specification:	FCC Part 15, Section 109 / RSS-Gen, Section 7.3 / ICES-003, Radiated emission		
Test procedure:	ANSI C63.4, Sections 8.3 and 12.2.5		
Test mode:	Compliance	Verdict: PASS	
Date(s):	07-Jul-20		
Temperature: 23 °C	Relative Humidity: 55 %	Air Pressure: 1012 hPa	Power: 120 VAC, 50 Hz
Remarks:			

Table 8.2.3 Radiated emission test results

EUT SET UP: TABLE-TOP
 LIMIT: Class B
 EUT OPERATING MODE: Receive
 TEST SITE: SEMI ANECHOIC CHAMBER
 TEST DISTANCE: 3 m
 DETECTORS USED: PEAK / QUASI-PEAK
 FREQUENCY RANGE: 30 MHz – 1000 MHz
 RESOLUTION BANDWIDTH: 120 kHz

Frequency, MHz	Peak emission, dB(µV/m)	Quasi-peak			Antenna polarization	Antenna height, m	Turn-table position**, degrees	Verdict
		Measured emission, dB(µV/m)	Limit, dB(µV/m)	Margin, dB*				
55.667	31.51	25.22	40.0	-14.78	Vertical	1.04	-166	Pass
62.340	31.14	24.02	40.0	-15.98	Vertical	1.02	180	
65.771	31.64	24.58	40.0	-15.42	Vertical	1.02	44	
78.206	29.49	22.11	40.0	-17.89	Vertical	1.32	95	
91.271	34.07	27.98	43.5	-15.52	Vertical	1.02	56	
99.373	29.57	22.95	43.5	-20.55	Vertical	1.04	95	

TEST SITE: SEMI ANECHOIC CHAMBER
 TEST DISTANCE: 3 m
 DETECTORS USED: PEAK / AVERAGE
 FREQUENCY RANGE: 1000 MHz – 5000 MHz
 RESOLUTION BANDWIDTH: 1000 kHz

Frequency, MHz	Peak			Average			Antenna polarization	Antenna height, m	Turn-table position**, degrees	Verdict
	Measured emission, dB(µV/m)	Limit, dB(µV/m)	Margin, dB*	Measured emission, dB(µV/m)	Limit, dB(µV/m)	Margin, dB*				
No emissions were found										Pass

*- Margin = Measured emission - specification limit.
 **- EUT front panel refer to 0 degrees position of turntable.

Reference numbers of test equipment used

HL 3903	HL 4360	HL 4933	HL 5085	HL 5288	HL 5665	HL 4011	HL 4339
---------	---------	---------	---------	---------	---------	---------	---------

Full description is given in Appendix A.



Test specification:	FCC Part 15, Section 109 / RSS-Gen, Section 7.3 / ICES-003, Radiated emission		
Test procedure:	ANSI C63.4, Sections 8.3 and 12.2.5		
Test mode:	Compliance	Verdict: PASS	
Date(s):	07-Jul-20		
Temperature: 23 °C	Relative Humidity: 55 %	Air Pressure: 1012 hPa	Power: 120 VAC, 50 Hz
Remarks:			

Plot 8.2.1 Radiated emission measurements in 30 - 1000 MHz range, vertical and horizontal antenna polarization

TEST SITE: Semi anechoic chamber
LIMIT: Class B
TEST DISTANCE: 3 m
EUT OPERATING MODE: Receive

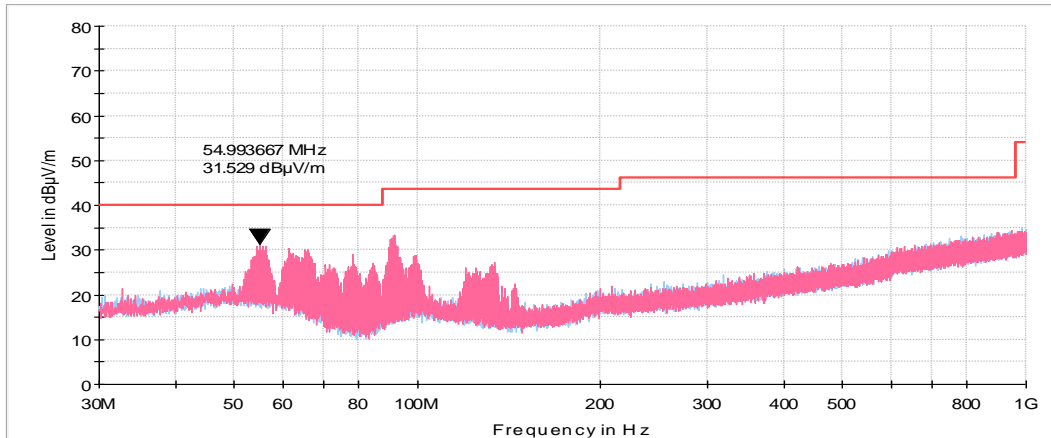

Plot 8.2.2 Radiated emission measurements above 1000 MHz, vertical and horizontal antenna polarization

TEST SITE: Semi anechoic chamber
LIMIT: Class B
TEST DISTANCE: 3 m
EUT OPERATING MODE: Receive

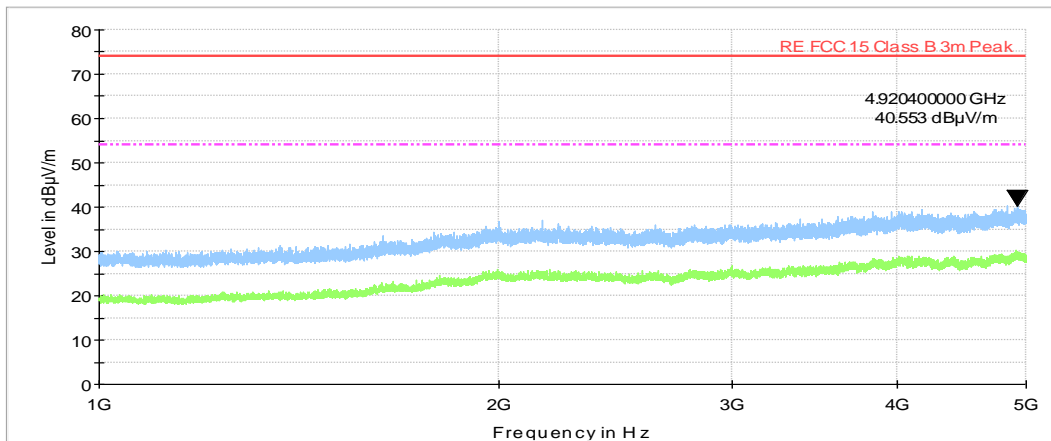

**9 APPENDIX A Test equipment and ancillaries used for tests**

HL No	Description	Manufacturer	Model	Ser. No.	Last Cal./ Check	Due Cal./ Check
0446	Antenna, Loop, Active, 10 (9) kHz - 30 MHz	EMCO	6502	2857	24-Feb-20	24-Feb-21
1809	HygroThermometer, Min/Max Memory	Delta TRAK	13301	NA	11-Aug-19	11-Aug-20
2382	Transformer, Isolation, 230/230, 1.8 kVA	Taiyo Yuden, Inc.	LGY1.8-21	FJ0411	03-Feb-20	03-Feb-21
3016	LISN, Two-line V-network, 9 kHz to 30 MHz, (50 uH+5 Ohm), CISPR16-1, MIL-461E	Rohde & Schwarz	ESH 3-Z5	892239/002	09-Feb-20	09-Feb-21
3901	Microwave Cable Assembly, 40.0 GHz, 3.5 m, SMA/SMA	Huber-Suhner	SUCOFL EX 102A	1225/2A	06-Apr-20	06-Apr-21
3903	Microwave Cable Assembly, 40.0 GHz, 1.5 m, SMA/SMA	Huber-Suhner	SUCOFL EX 102A	1226/2A	06-Apr-20	06-Apr-21
4011	Temp. & Humidity Meter, (-50 - +70) deg, (20 - 99)% RH	Mad Electronics	HTC-1	NA	12-Aug-20	12-Aug-21
4136	Shield Box	TESCOM CO., LTD	TC-5916A	5916A000137	23-Apr-20	23-Apr-21
4339	High pass Filter, 50 Ohm, 1000 to 18000 MHz, SMA-FM / SMA-M	Micro-Tronics	HPM5011 5-02	001	05-Jun-19	05-Jun-21
4360	EMI Test Receiver, 20 Hz to 40 GHz.	Rohde & Schwarz	ESU40	100322	20-Jan-20	20-Jan-21
4528	DC block , 50 Ohm, 10 MHz to 6 GHz	Mini-Circuits	*****	NA	06-Feb-20	06-Feb-21
4933	Active Horn Antenna, 1 GHz to 18 GHz	COM-POWER CORPORATION	AHA-118	701046	06-Jan-20	06-Jan-21
5085	Attenuator, 4 dB, DC - 6 GHz, 1 W	Mini-Circuits	UNAT-4+	NA	22-May-20	22-May-21
5288	Trilog Antenna, 25 MHz - 8 GHz, 100W	Frankonia	ALX-8000E	00809	08-Feb-19	08-Feb-22
5376	EXA Signal Analyzer, 10 Hz - 32 GHz	Keysight Technologies	N9010B	MY57470404	18-Mar-20	18-Mar-21
5397	H-field near field probe, 3 cm	ETS Lindgren	7405-902	NA	16-Aug-20	16-Aug-22
5476	Cable, BNC/BNC, 10.5 m	Western wire	MIL-C-17G	NA	14-May-20	14-May-21
5601	Precision Fixed Attenuator, 50 Ohm, 5 W, 10 dB, DC to 18000 MHz	Mini Circuits	BW-N10W5+	NA	24-Sep-19	24-Sep-20
5665	Cable SF118/11N(x2)/6M, 18 GHz, 11N/11N	Huber-Suhner	SF118	501644/118	19-Apr-20	19-Apr-21
5700	Temp. & Humidity Meter, (-10 - +50) deg, (10 - 99)% RH	Mad Electronics	HTC-1	NA	02-Dec-19	02-Dec-20



10 APPENDIX B Test equipment correction factors

HL 0446: Active Loop Antenna
EMCO, model: 6502, s/n 2857

Frequency,	Measured antenna factor, dBS/m	Measurement uncertainty, dB
10	-33.4	±1.0
20	-37.8	±1.0
50	-40.5	±1.0
75	-41.0	±1.0
100	-41.2	±1.0
150	-41.2	±1.0
250	-41.1	±1.0
500	-41.2	±1.0
750	-41.3	±1.0
1000	-41.3	±1.0

Frequency,	Measured antenna factor, dBS/m	Measurement uncertainty, dB
2000	-41.4	±1.0
3000	-41.4	±1.0
4000	-41.5	±1.0
5000	-41.5	±1.0
10000	-41.7	±1.0
15000	-42.1	±1.0
20000	-42.7	±1.0
25000	-44.2	±1.0
30000	-45.8	±1.0

The antenna factor shall be added to receiver reading in dB μ V to obtain field strength in dB μ A/m.

HL 5288: Trilog Antenna
Frankonia, model: ALX-8000E, s/n: 00809

Frequency, MHz	Antenna factor, dB/m
1000	26.9
1100	28.1
1200	28.4
1300	29.6
1400	29.1
1500	30.4
1600	30.7
1700	31.5
1800	32.3
1900	32.6
2000	32.5
2100	32.9
2200	33.5
2300	33.2
2400	33.7
2500	34.6
2600	34.7
2700	34.6
2800	35.0
2900	35.5
3000	36.2
3100	36.8
3200	36.8
3300	37.0
3400	37.5
3500	38.2

Frequency, MHz	Antenna factor, dB/m
3600	38.9
3700	39.4
3800	39.4
3900	39.6
4000	39.7
4100	39.8
4200	40.5
4300	40.9
4400	41.1
4500	41.4
4600	41.3
4700	41.6
4800	41.9
4900	42.3
5000	42.7
5100	43.0
5200	42.9
5300	43.5
5400	43.6
5500	44.3
5600	44.7
5700	45.0
5800	45.0
5900	45.3
6000	45.9

The antenna factor shall be added to receiver reading in dB μ V to obtain field strength in dB μ V/m.



HL 3016: LISN /50 uH + 5 Ohm
Rohde & Schwarz, model: ESH 3-Z5, s/n: 892239/002

Frequency,	L1, dB	L2, dB	Uncertainty, dB
10	0.68	0.70	±0.12
15	0.41	0.42	±0.12
20	0.29	0.28	±0.12
25	0.22	0.21	±0.12
30	0.18	0.17	±0.08
40	0.13	0.13	±0.08
50	0.11	0.11	±0.08
60	0.10	0.10	±0.09
70	0.09	0.09	±0.09
80	0.09	0.09	±0.09
90	0.09	0.09	±0.09
100	0.09	0.08	±0.09
150	0.08	0.08	±0.09
170	0.08	0.08	±0.09
200	0.08	0.08	±0.09
250	0.09	0.08	±0.09
300	0.09	0.08	±0.09
350	0.09	0.09	±0.09
400	0.09	0.09	±0.09

Frequency,	L1, dB	L2, dB	Uncertainty, dB
500	0.09	0.09	±0.09
600	0.10	0.09	±0.09
700	0.10	0.10	±0.09
800	0.10	0.10	±0.09
900	0.10	0.11	±0.09
1000	0.11	0.11	±0.09
1200	0.11	0.11	±0.16
1500	0.12	0.12	±0.16
2000	0.14	0.14	±0.16
2500	0.15	0.14	±0.16
3000	0.17	0.16	±0.16
4000	0.20	0.20	±0.16
5000	0.23	0.23	±0.16
7000	0.35	0.35	±0.16
10000	0.45	0.44	±0.16
15000	0.75	0.09	±0.16
20000	0.91	0.09	±0.16
30000	1.15	0.10	±0.32

HL 4933 Active Horn Antenna, 1 GHz to 18 GHz
COM-POWER CORPORATION AHA-118 , s/n 701046

Frequency, MHz	Measured antenna factor, dB/m
1000	-16.1
1050	-16.0
1100	-15.1
1150	-16.4
1200	-16.0
1250	-15.6
1300	-15.1
1350	-14.8
1400	-15.1
1450	-15.1
1500	-15.5
1550	-15.2
1600	-14.7
1650	-14.4
1700	-14.4
1750	-14.0
1800	-13.6
1850	-12.7
1900	-11.9
1950	-11.9
2000	-11.8
2050	-11.3
2100	-11.3
2150	-11.7
2200	-12.3
2250	-12.3
2300	-12.4
2350	-12.2
2400	-11.7
2450	-11.5
2500	-11.5
2550	-11.5
2600	-11.5
2650	-11.3
2700	-11.3
2750	-11.1
2800	-11.1
2850	-11.3
2900	-11.1
2950	-11.0
3000	-11.1
3050	-10.9
3100	-10.7
3150	-10.6

Frequency, MHz	Measured antenna factor, dB/m
3200	-11.2
3250	-10.8
3300	-10.8
3350	-10.7
3400	-10.3
3450	-10.2
3500	-10.1
3550	-10.4
3600	-10.5
3650	-10.4
3700	-10.4
3750	-10.3
3800	-10.1
3850	-10.0
3900	-9.9
3950	-9.8
4000	-9.7
4050	-9.3
4100	-8.6
4150	-8.2
4200	-8.3
4250	-8.5
4300	-8.5
4350	-8.3
4400	-8.0
4450	-7.7
4500	-7.6
4550	-7.4
4600	-7.5
4650	-7.8
4700	-7.6
4750	-6.8
4800	-6.1
4850	-5.7
4900	-5.8
4950	-5.8
5000	-6.0
5050	-5.7
5100	-5.4
5150	-5.1
5200	-4.6
5250	-4.6
5300	-4.8
5350	-5.1

11 APPENDIX C Measurement uncertainties

Expanded uncertainty at 95% confidence in Hermon Labs EMC measurements

Test description	Expanded uncertainty
Conducted emissions with LISN	9 kHz to 150 kHz: ± 3.9 dB 150 kHz to 30 MHz: ± 3.8 dB
Radiated emissions at 10 m measuring distance Horizontal polarization Vertical polarization	Biconilog antenna: ± 5.0 dB Biconical antenna: ± 5.0 dB Log periodic antenna: ± 5.1 dB Double ridged horn antenna: ± 5.3 dB Biconilog antenna: ± 5.5 dB Biconical antenna: ± 5.5 dB Log periodic antenna: ± 5.6 dB Double ridged horn antenna: ± 5.8 dB
Radiated emissions at 3 m measuring distance Horizontal polarization Vertical polarization	Biconilog antenna: ± 5.3 dB Biconical antenna: ± 5.0 dB Log periodic antenna: ± 5.3 dB Double ridged horn antenna: ± 5.3 dB Biconilog antenna: ± 6.0 dB Biconical antenna: ± 5.7 dB Log periodic antenna: ± 6.0 dB Double ridged horn antenna: ± 6.0 dB
Conducted emissions at RF antenna connector	9 kHz to 2.9 GHz: ± 2.6 dB 2.9 GHz to 6.46 GHz: ± 3.5 dB 6.46 GHz to 13.2 GHz: ± 4.3 dB 13.2 GHz to 22.0 GHz: ± 5.0 dB 22.0 GHz to 26.8 GHz: ± 5.5 dB 26.8 GHz to 40.0 GHz: ± 4.8 dB
Duty cycle, timing (Tx ON / OFF) and average factor measurements	± 1.0 %
Occupied bandwidth	± 8.0 %

Hermon Laboratories is accredited by A2LA for calibration according to present requirements of ISO/IEC 17025 and NCSL Z540-1. The accreditation is granted to perform calibration of parameters that are listed in the Scope of Hermon Laboratories Accreditation.

Hermon Laboratories calibrates its reference and transfer standards by calibration laboratories accredited to ISO/IEC 17025 by a mutually recognized Accreditation Body or by a recognized national metrology institute. All reference and transfer standards used in the calibration system are traceable to national or international standards.

In-house calibration of all test and measurement equipment is performed on a regular basis according to Hermon Laboratories calibration procedures, manufacturer calibration/verification procedures or procedures defined in the relevant standards. The Hermon Laboratories test and measurement equipment is calibrated within the tolerances specified by the manufacturers and/or by the relevant standards.

12 APPENDIX D Test laboratory description

Tests were performed at Hermon Laboratories Ltd., which is a fully independent, private, EMC, Radio, Safety, Environmental and Telecommunication testing facility.

Hermon Laboratories is recognized and accredited by the Federal Communications Commission (USA) for 1, 2, 15, 18 parts of Code of Federal Regulations 47 (CFR 47), Test Firm Registration Number is 927748, Designation Number is IL1001; registered by Industry Canada for electromagnetic emissions, file number IC 2186A-1 for OATS, certified by VCCI, Japan (the registration numbers are R-10808 for OATS, R-1082 for anechoic chamber, G-10869 for RE measurements above 1 GHz, C-10845 for conducted emissions site and T-11606 for conducted emissions at telecommunication ports).

The laboratory is accredited by American Association for Laboratory Accreditation (USA) according to ISO/IEC 17025 for electromagnetic compatibility, product safety, telecommunications testing, environmental simulation and calibration (for exact scope please refer to Certificate No. 839.01, 839.03 and 839.04).

Address: P.O. Box 23, Binyamina 3055001, Israel
Telephone: +972 4628 8001
Fax: +972 4628 8277
e-mail: mail@hermonlabs.com
website: www.hermonlabs.com

Person for contact: Mr. Michael Nikishin, EMC and radio group manager

13 APPENDIX E Specification references

FCC 47CFR part 15: 2019	Radio Frequency Devices.
ANSI C63.4: 2014	American National Standard for Methods of Measurement of Radio-Noise Emissions from Low-Voltage Electrical and Electronic Equipment in the Range of 9 kHz to 40 GHz.
ANSI C63.10: 2013	American National Standard of Procedures for Compliance Testing of Unlicensed Wireless Devices
RSS-210 Issue 10: 2019	Licence-Exempt Radio Apparatus: Category I Equipment
RSS-Gen Issue 5: 2019	General Requirements for Compliance of Radio Apparatus
ICES-003: 2017, Issue 6	Information Technology Equipment (Including Digital Apparatus) – Limits and methods of measurement



14 APPENDIX F Abbreviations and acronyms

A	ampere	m	meter
AC	alternating current	MHz	megahertz
A/m	ampere per meter	min	minute
AM	amplitude modulation	mm	millimeter
AVRG	average (detector)	ms	millisecond
cm	centimeter	μ s	microsecond
dB	decibel	NA	not applicable
dBm	decibel referred to one milliwatt	NB	narrow band
dB(μ V)	decibel referred to one microvolt	OATS	open area test site
dB(μ V/m)	decibel referred to one microvolt per meter	Ω	Ohm
dB(μ A)	decibel referred to one microampere	PM	pulse modulation
DC	direct current	PS	power supply
EIRP	equivalent isotropically radiated power	ppm	part per million (10^{-6})
ERP	effective radiated power	QP	quasi-peak
EUT	equipment under test	RE	radiated emission
F	frequency	RF	radio frequency
GHz	gigahertz	rms	root mean square
GND	ground	Rx	receive
HL	Hermon laboratories	s	second
Hz	hertz	T	temperature
k	kilo	Tx	transmit
kHz	kilohertz	V	volt
LO	local oscillator	WB	wideband

END OF DOCUMENT