

CSG300s Label Instruction

Revision	Description	Date
A	Initial release	Feb. 10, 2020

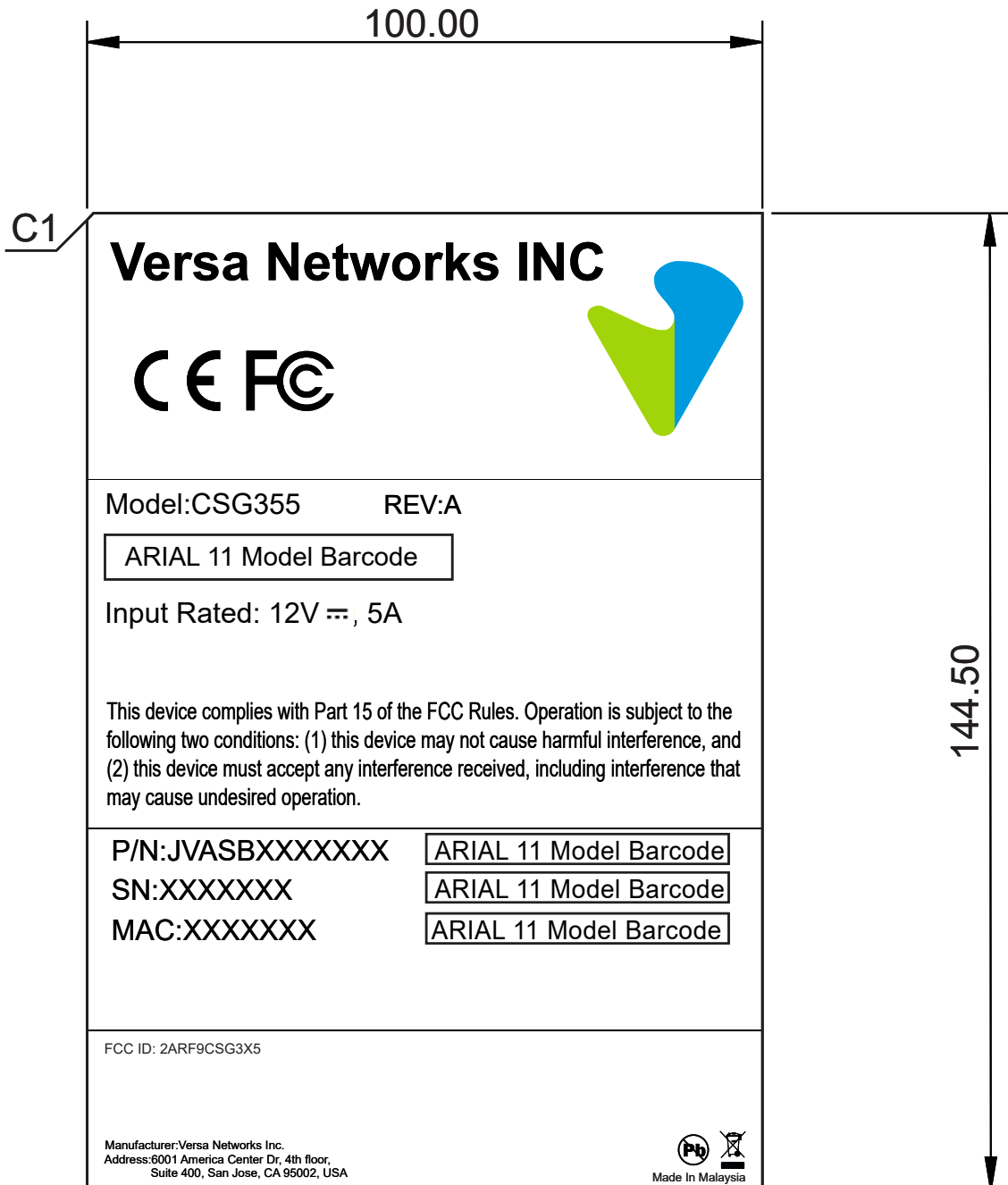

Notes:

The version is only for reference. Please follow the latest version on Windchill.

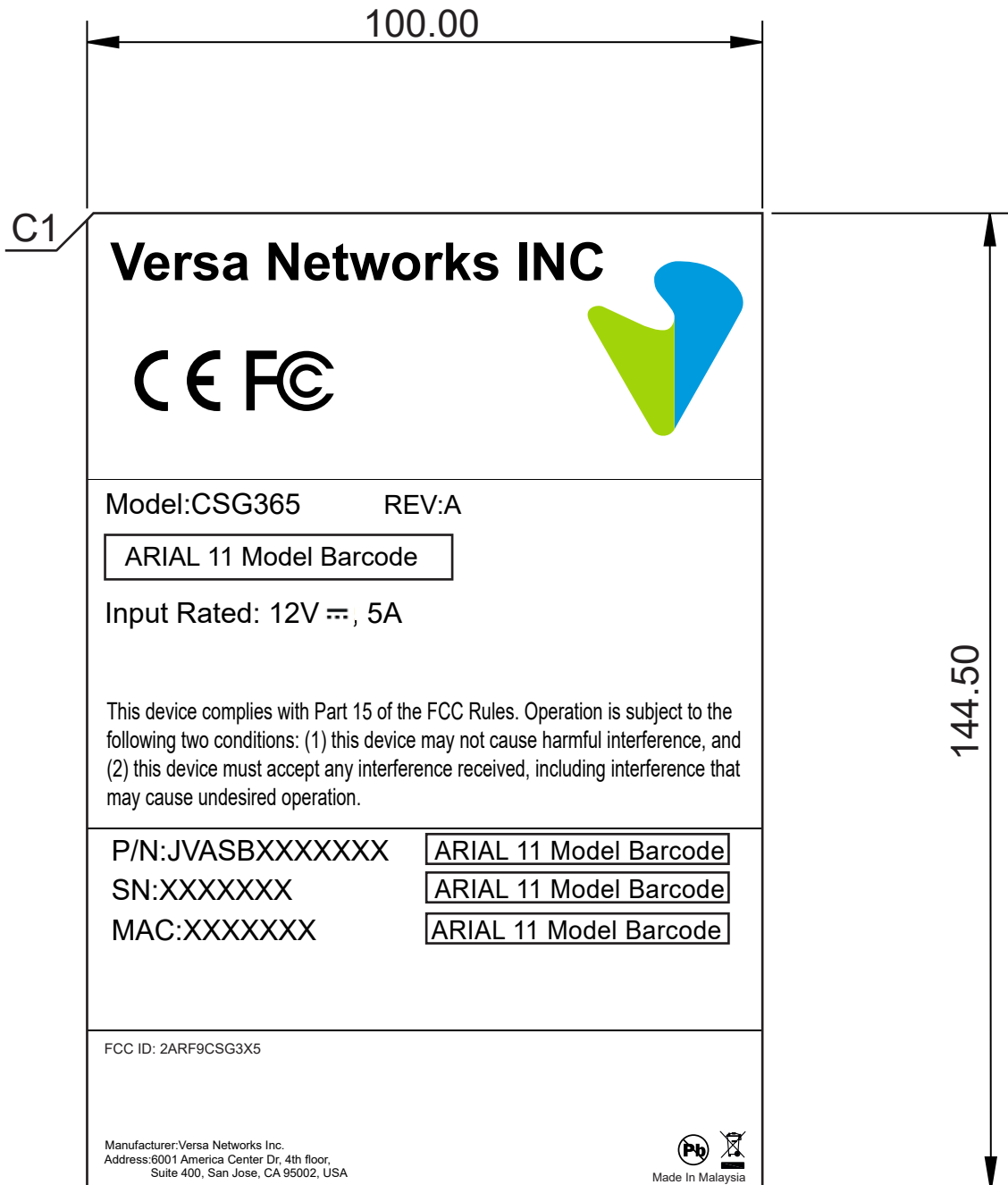

Notes:

The version is only for reference. Please follow the latest version on Windchill.

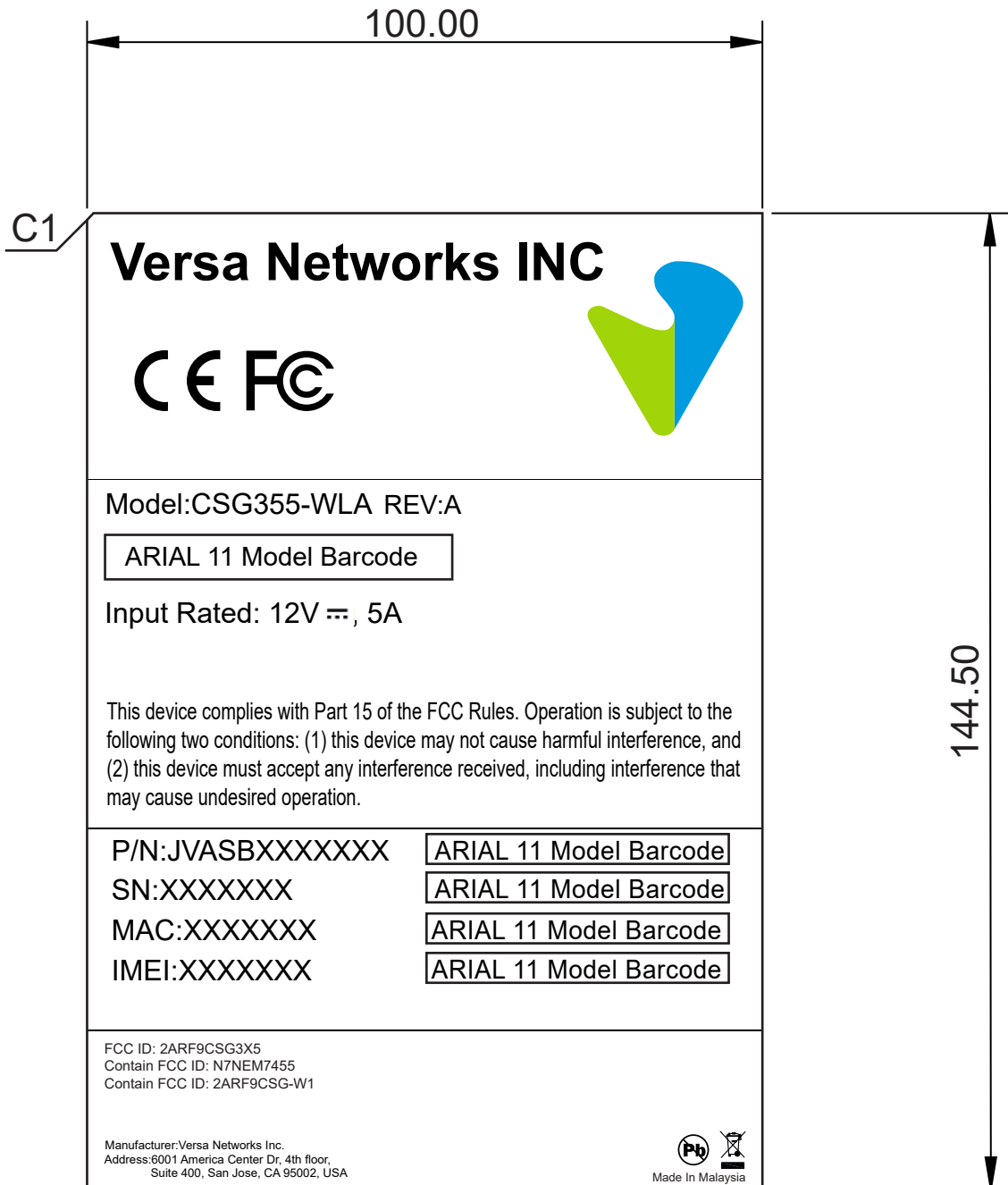

Notes:

The version is only for reference. Please follow the latest version on Windchill.

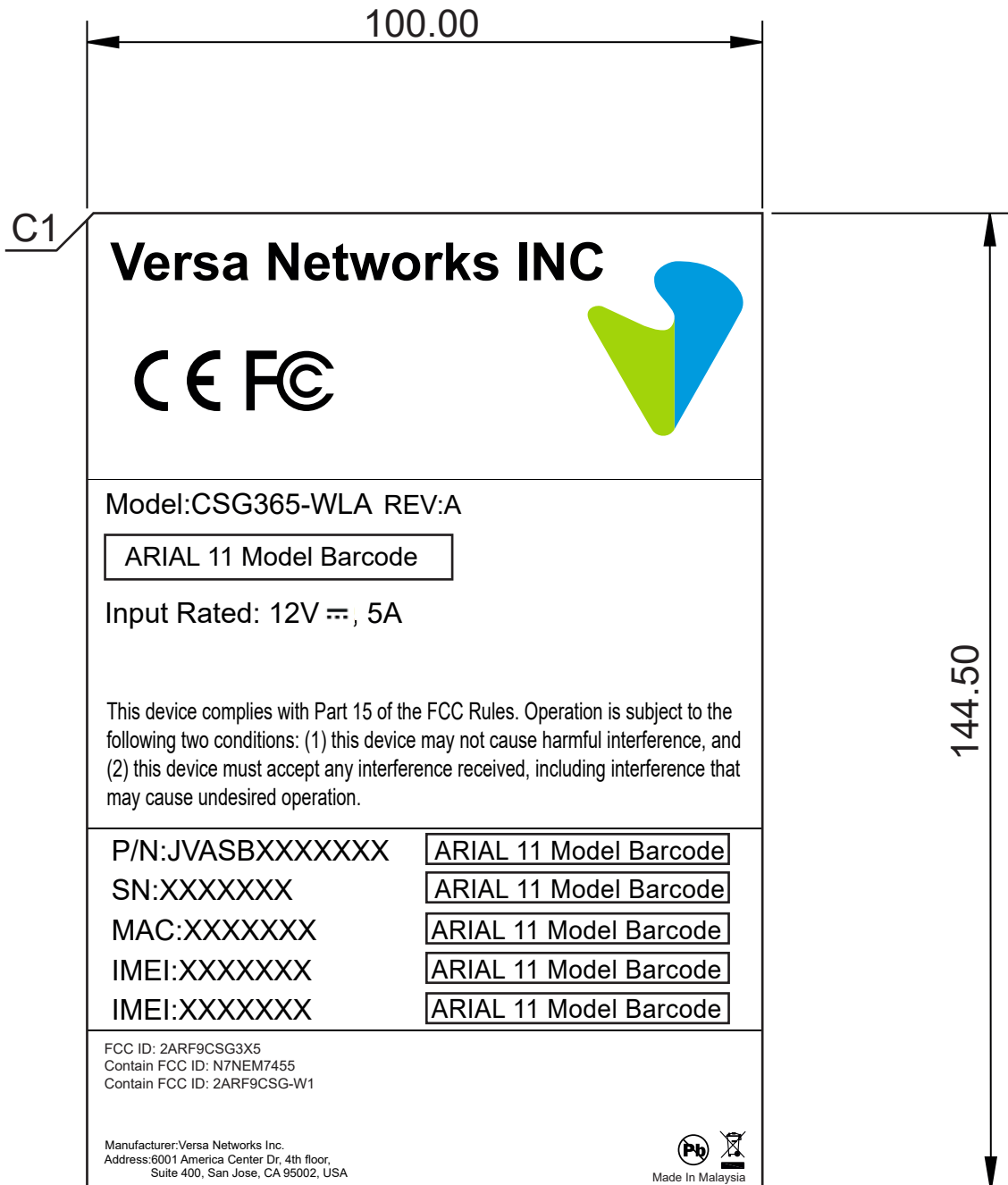

Notes:

The version is only for reference. Please follow the latest version on Windchill.

Front : ARIAL BLACK
Size: 20

Front : ARIAL
Size: 12

Front : ARIAL
Size: 12



Front : ARIAL
Size: 10

Front : ARIAL
Size: 12

Front : ARIAL
Size: 6

Front : ARIAL
Size: 5

Front : ARIAL
Size: 5

Versa Networks INC	
	
Model:CSG355 REV:A	
ARIAL 11 Model Barcode	
Input Rated: 12V $\overline{\text{---}}$, 5A	
This device complies with Part 15 of the FCC Rules. Operation is subject to the following two conditions: (1) this device may not cause harmful interference, and (2) this device must accept any interference received, including interference that may cause undesired operation.	
P/N:JVASBXXXXXXXX	ARIAL 11 Model Barcode
SN:XXXXXXXX	ARIAL 11 Model Barcode
MAC:XXXXXXXX	ARIAL 11 Model Barcode
IMEI:XXXXXXXX	ARIAL 11 Model Barcode
IMEI:XXXXXXXX	ARIAL 11 Model Barcode
FCC ID: 2ARF9CSG3X5	
Manufacturer:Versa Networks Inc. Address:6001 America Center Dr, 4th floor, Suite 400, San Jose, CA 95002, USA	
 Made In Malaysia	

NOTE:

Barcodes: Code 39 or 128, Grade C or better

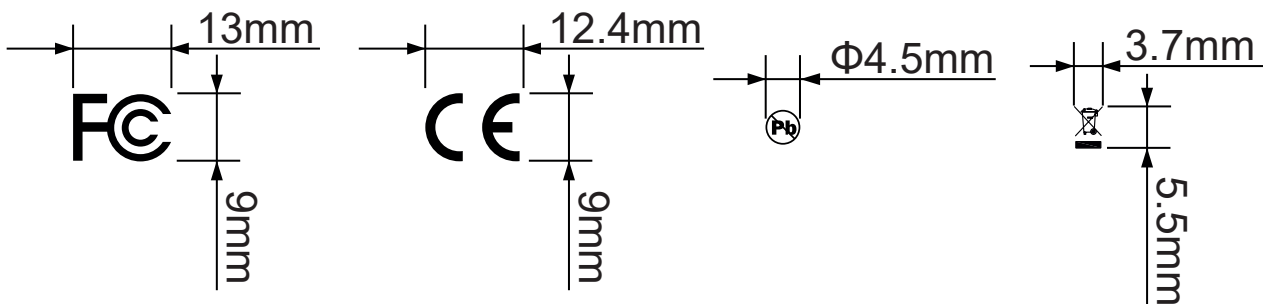

Model	FCC ID Label
CSG355	FCC ID: 2ARF9CSG3X5
CSG355-W	FCC ID: 2ARF9CSG3X5 Contain FCC ID: 2ARF9CSG-W1
CSG355-LA	FCC ID: 2ARF9CSG3X5 Contain FCC ID: N7NEM7455
CSG355-2LA	FCC ID: 2ARF9CSG3X5 Contain FCC ID: N7NEM7455
CSG355-WLA	FCC ID: 2ARF9CSG3X5 Contain FCC ID: N7NEM7455 Contain FCC ID: 2ARF9CSG-W1
CSG365	FCC ID: 2ARF9CSG3X5
CSG355-W	FCC ID: 2ARF9CSG3X5 Contain FCC ID: 2ARF9CSG-W1
CSG365-LA	FCC ID: 2ARF9CSG3X5 Contain FCC ID: N7NEM7455
CSG365-2LA	FCC ID: 2ARF9CSG3X5 Contain FCC ID: N7NEM7455
CSG365-WLA	FCC ID: 2ARF9CSG3X5 Contain FCC ID: N7NEM7455 Contain FCC ID: 2ARF9CSG-W1

Label Location

