

# CSG300s Label Instruction

Revision	Description	Date
A	Initial release	Feb. 10, 2020

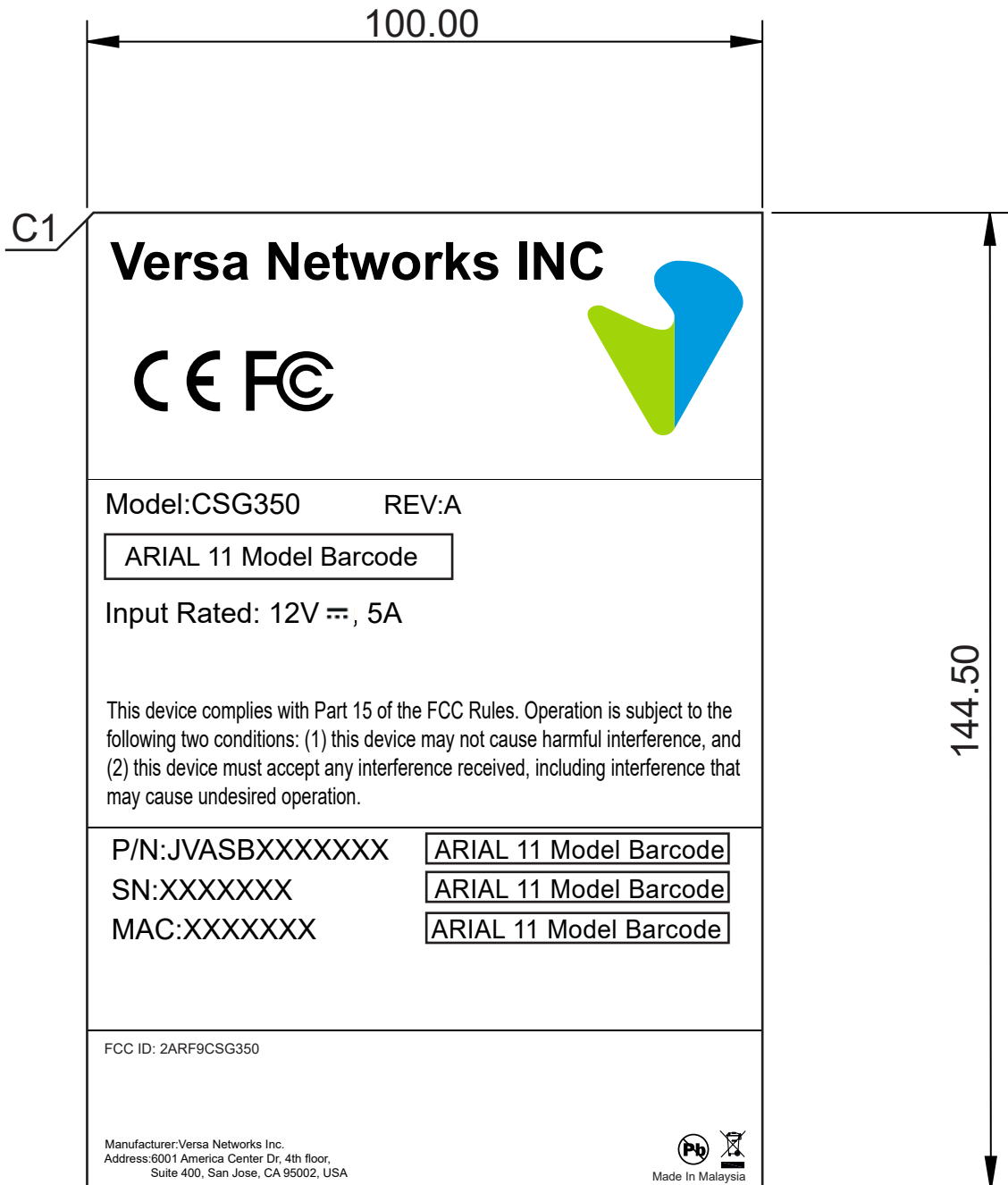

**Notes:**

The version is only for reference. Please follow the latest version on Windchill.

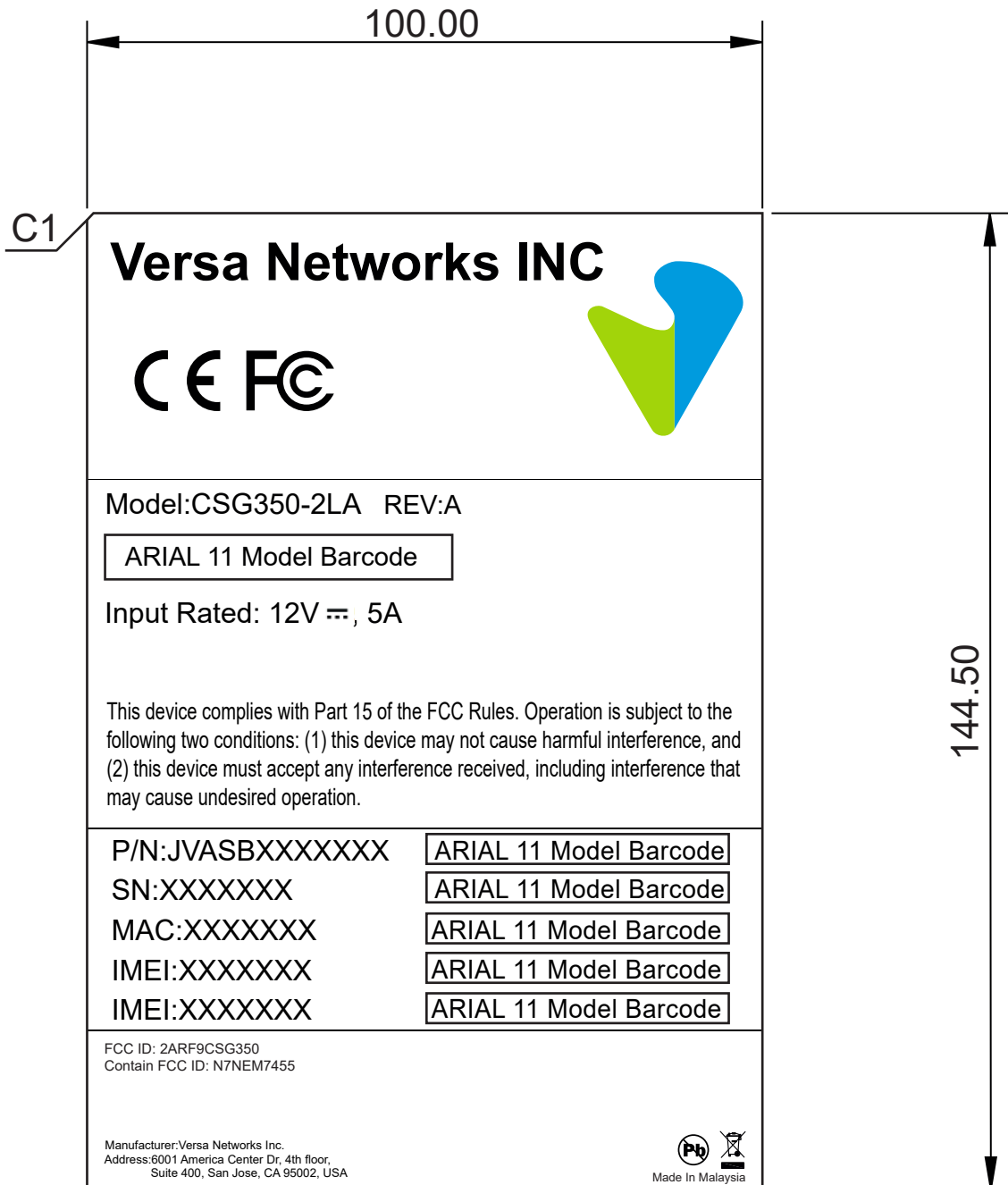

**Notes:**

The version is only for reference. Please follow the latest version on Windchill.

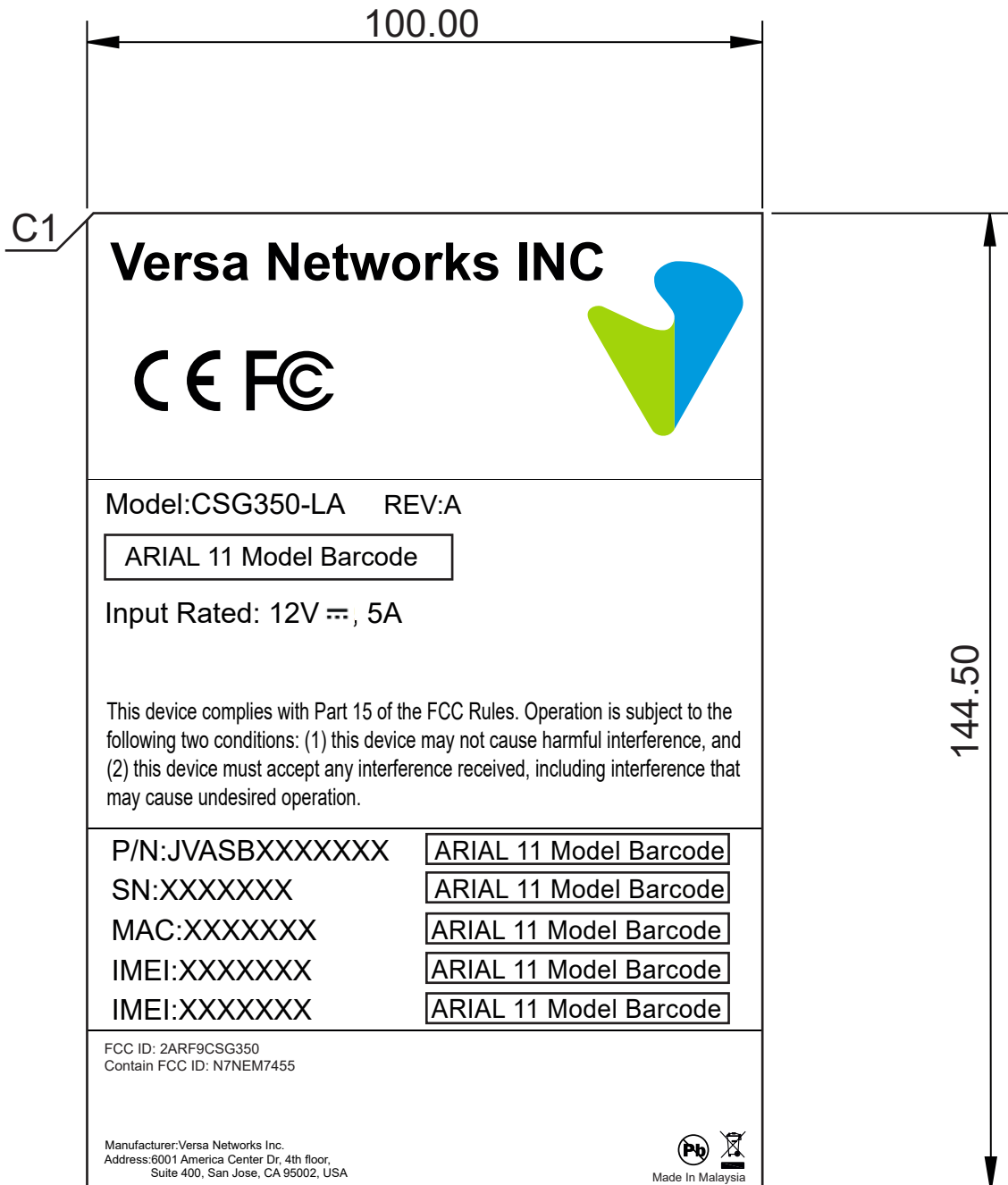

**Notes:**

The version is only for reference. Please follow the latest version on Windchill.

Front : ARIAL BLACK  
Size: 20

Front : ARIAL  
Size: 12

Front : ARIAL  
Size: 12



Front : ARIAL  
Size: 10

Front : ARIAL  
Size: 12

Front : ARIAL  
Size: 6

Front : ARIAL  
Size: 5

Front : ARIAL  
Size: 5

<b>Versa Networks INC</b>	
	
Model:CSG350      REV:A	
[ ARIAL 11 Model Barcode ]	
Input Rated: 12V $\overline{\text{---}}$ 5A	
This device complies with Part 15 of the FCC Rules. Operation is subject to the following two conditions: (1) this device may not cause harmful interference, and (2) this device must accept any interference received, including interference that may cause undesired operation.	
P/N:JVASBXXXXXXXX	[ ARIAL 11 Model Barcode ]
SN:XXXXXXXX	[ ARIAL 11 Model Barcode ]
MAC:XXXXXXXX	[ ARIAL 11 Model Barcode ]
IMEI:XXXXXXXX	[ ARIAL 11 Model Barcode ]
IMEI:XXXXXXXX	[ ARIAL 11 Model Barcode ]
FCC ID: 2ARF9CSG350	
Manufacturer:Versa Networks Inc. Address:6001 America Center Dr, 4th floor, Suite 400, San Jose, CA 95002, USA	
 Made In Malaysia	

NOTE:

Barcodes: Code 39 or 128, Grade C or better

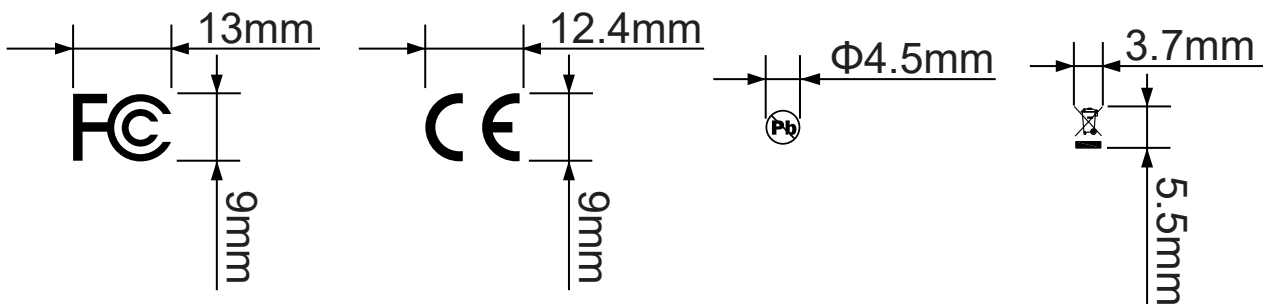

# Label Location

