CSG700 Series Hardware Guide

At a Glance

The Versa Cloud Services Gateway (CSG) 700 series appliances deliver highly secure site-to-site data connectivity to small- and medium-sized businesses and to home offices.

These appliances provide the following features:

- Unified board design that supports different CPUs and memory sizes
- Up to 10 Ethernet ports including:
 - Four built-in 1 Gigabit per second (GB) Ethernet over copper (EoC) ports
 - Two 1-GB EoC or SFP ports, available through separate interfaces
 - Four 1-GB EoC with Power over Ethernet (PoE) ports, available if a Network Interface Card (NIC) module is installed
- MDI and MDIX autoswitchable EoC ports
- Two USB ports for plugging in external LTE or WiFi modems
- PoE source support on four Ethernet ports
- Two built-in wireless slots
- GPS connector for geographical location
- External AC power supply
- Kensington security lock to physically lock down the appliance
- Fanless design
- Fixed chassis with no field-replaceable parts
- Desktop mount or rack-mountable in a 19" rack

CSG700 Appliance Models

The CSG700 appliances are available in the following models:

- CSG730
- CSG750
- CSG770

The CSG 700 appliance models differ only in CPU, memory, and storage size. See Table 1.

Table 1: CSG700 Appliance Models

CSG Appliance Model	CPU	Memory	Storage
CSG730	Intel Denverton with 2 cores	4 GB DRAM	32 GB
CSG750	Intel Denverton with 4 cores	8 GB DRAM	64 GB
CSG770	Intel Denverton with 8 cores	16 GB DRAM	128 GB

Chassis Views

Figure 1 and Figure 2 show the front and rear panels of the CSG730 appliance. The panels for the CSG750 and CSG770 appliances are identical to the CSG730 appliance.

Note: The front panel is the side of the appliance with the SIM slots and two LEDs, for status and power. This is the side that is visible when you install the appliance in an office environment. The rear panel has the power and reset buttons and various connectors and ports. This is the side that is visible when you mount the appliance in a 19-inch rack.

Figure 1: Front Panel of the CSG730 Appliance

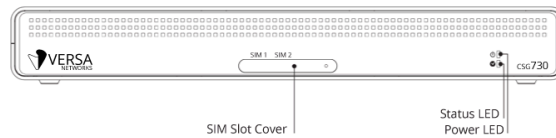
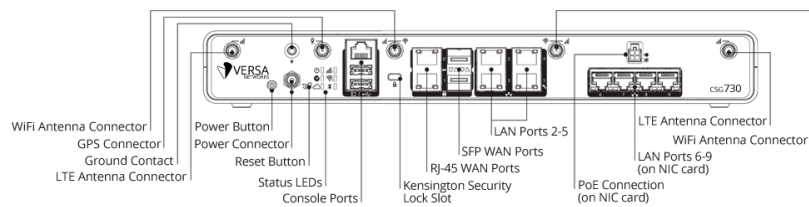

Figure 2: Rear Panel of the CSG730 Appliance



CSG700 Series Appliance Specifications

A CSG700 series appliance chassis is made of aluminum for optimal heat dissipation. This article lists the chassis and

https://docs.versa-networks.com/Hardware/Cloud_Services_Gateway_700_Series/Complete_CSG700_Series_Hardware_Gui...

Updated: Tue, 18 Oct 2022 06:10:27 GMT

Copyright © 2021, Versa Networks, Inc.

regulatory compliance specifications for a CSG700 series appliance. It also lists certifications and export control classification numbers (ECCNs) for the appliance.

Chassis Specifications

Table 1 lists the chassis specifications for a CSG700 series chassis.

Table 1: CSG700 Series Chassis Specifications

Item	Specification
Services and Slot Density	
RJ-45 ports 10/100/1000 Mbps	4 + 2
SFP Ethernet ports	2
External USB ports (USB 2.0)	2
RJ-45 serial console port	1
Memory DDR4 ECC DRAM	CSG730: 4 GB CSG750: 8 GB CSG770: 16 GB
Disk 1 SSD, M.2 SATA-based	1
Disk 1 SSD default size	CSG730: 32 GB CSG750: 64 GB CSG770: 128 GB
Disk 2 and Disk 3, USB-based	Flexible
Power supply	AC input
Power Specifications	
AC input voltage	100–240 Volts
AC input line frequency	50–60 Hz
Typical power consumption with PoE disabled	35 Watts
Typical power consumption with PoE enabled	60 Watts
Chassis Physical Specifications	
Chassis height	1.73" (4.4 cm)

Item	Specification
Chassis width	8.75" (22 cm)
Chassis depth	13.25" (33.6 cm)
Rack height	1 RU
Chassis weight	5.84 lb (2.65 kg)
Package Specifications	
Package height	7" (17.78 cm)
Package width	16.7" (42.4 cm)
Package depth	12" (30.48 cm)
Package weight	15.4 lb (7 kg)
Operating Conditions	
Temperature	<ul style="list-style-type: none"> • -25 to 60°C (-13 to 140°F), for CSG730 appliances, which are temperature-hardened • 0 to 40°C (32 to 104°F), for CSG750 and CSG770 appliances
Humidity	10 to 85% relative humidity
Altitude	Maximum 3000 m (10000 ft)
Noise level	0 dBm
Storage Conditions	
Temperature	-20 to 70°C (-4 to 158°F) at sea level
Humidity	10 to 85% relative humidity

CSG700 Series Appliance SKUs

CSG700 series SKUs have the following format:

model – xxx – yyy

model indicates the CSG700 appliance model number. It can be one of the following:

- CSG730

https://docs.versa-networks.com/Hardware/Cloud_Services_Gateway_700_Series/Complete_CSG700_Series_Hardware_Gui...

Updated: Tue, 18 Oct 2022 06:10:27 GMT

Copyright © 2021, Versa Networks, Inc.

- CSG750
- CSG770

xxx indicates the number and type of wireless modules. It can be one of the following:

- WLA—1 WiFi module and 1 LTE module (North America)
- WLB—1 WiFi module and 1 LTE module (APAC)
- 2LA—2 LTE modules (North America)
- 2LB—2 LTE modules (APAC)
- LA—1 LTE module (North America)
- LB—1 LTE module (APAC)
- W—1 WiFi Module
- Blank—No LTE or WiFi Module

yyy indicates part of model name, It can be one of the following:

- 4GP-120W
- 4DS
- 4GF
- 8GE
- 1VA

Regulatory Compliance

Table 2 lists the regulatory compliance specifications for a CSG700 series chassis.

Table 2: CSG700 Series Regulatory Compliance Specifications

Item	Specification
Safety	CB (IEC/EN60950-1 and IEC/EN 62368-1) UL (CSA 22.2 No 62368-1 and UL62368-1)
Security	TPM 2.0 Designed to be FIPS 140-2 Level 2 compliant
EMC	CE, FCC Part 15, Class A
Environmental	RoHS

Certifications

A CSG700 series appliance complies with the product safety and regulatory compliance listed in Table 3. For the latest list of certifications and regulatory compliance for various regions, contact Versa Networks customer support.

Table 3: CSG700 Series Certifications

Region	Certifications
European Union	<p>Safety:</p> <ul style="list-style-type: none">• EN 60950-1:2005• EN 62368-1:2014 <p>EMC and Radio Frequency (Bluetooth, GPS, and MPE (SAR Evaluation)):</p> <ul style="list-style-type: none">• EN 301 489-1 V2.2.3 (2019-11) Class A• EN 301 489-17 V3.1.1 (2017-02)• Draft EN 301 489-52 V1.1.0 (2016-11)• EN 301 893 V2.1.1 (2017-05)• EN 301 893-19 V2.1.1 (2019-04)• EN 300 328 V2.1.1 (2016-11)• EN 301 908-1 V11.1.1 (2016-07)• EN 55032:2015/AC:2016 Class A• EN 55024:2010/A1:2015• EN 55035: 2017• EN 50385:2017
America	<p>Safety:</p> <ul style="list-style-type: none">• UL 62368-1, Second Edition. <p>EMI and Wireless:</p> <ul style="list-style-type: none">• FCC 47 CFR Part 15, Subpart B, Class A• FCC 47 CFR Part 15C, Subpart C (Section 15.247)
Japan	<p>Telecom, Radio, EMI:</p> <ul style="list-style-type: none">• JATE - Article 9 and34

Region	Certifications
	<ul style="list-style-type: none"> • MIC - ARIB STD-T66 (V3.7) • VCCI - CISPR 32:2016 Class A

Export Control Information

Table 4 lists the ECCN, HTS, and CCATS numbers.

Table 4: ECCN, HTS, and CCATS Numbers

Item	ECCN Number	HTS Number	CCATS Number	Versa Use of Item
MatrixSSL software module	5E002	8542310000	G161333	SSL VPN Proxy
QuickSec IPsec toolkit used by Versa Analytics, Versa Director and Versa Operating System™ (VOS™) device	5D002	8542310000	G161333	IPsec crypto module
Hardware-based encryption and decryption	5A002U	8542310001	G156910L1	CSG700 series appliance

Front and Rear Panel Components

This article describes the front and rear panel components of a CSG700 series appliance. For the exact location of these components on the appliance, see [At a Glance](#).

Front Panel

The front panel of a CSG700 series appliance has two status LEDs and two SIM card slots.

LEDs

Table 1 lists the LEDs, their colors and states, and the status they indicate.

Table 1: Front Panel LEDs in a CSG700 Series Appliance

LED	Color	Status
Power	Green	<ul style="list-style-type: none"> • Off—Appliance is not powered on. • Green—Appliance is powered on.
Status	Green, Red	<ul style="list-style-type: none"> • Off—Appliance hardware is up, but there is a problem with the configuration or software. • Solid green—Controller connection is up and running, and probes and control plane packets are being transmitted. • Blinking green—A Controller connection is in the process of being established. • Solid red—Controller or CA has rejected this appliance, there is a certificate mismatch, or the appliance is unreachable. • Blinking red—Controller is unreachable or unresponsive.

SIM Card Slots

The front panel of a CSG700 series appliance has two nano-SIM card slots. If you subscribe to a single wireless service, use the SIM 1 slot to install the LTE device. If you are subscribing to dual wireless service, use both the SIM 1 and SIM 2 slots to activate the LTE devices.

Note: It is strongly recommended that you use only preactivated SIMs in the SIM card slots.

Rear Panel

The rear panel of a CSG700 series appliance has six status LEDs, power and reset buttons, a Kensington security lock slot, and an input for a GPS antenna.

LEDs

The rear panel of a CSG700 series appliance has six LEDs located in two rows.

Table 2 lists the LEDs, their color and states, and the status they indicate.

Table 2: Rear Panel LEDs in a CSG700 Series Appliance

LED	Color	Status
Power	Green	<ul style="list-style-type: none"> • Off—Appliance is not powered on. • Green—Appliance is powered on.
Status	Green, Red	<ul style="list-style-type: none"> • Off—Appliance hardware is up, but there is a problem with the configuration or software. • Solid green—Controller connection is up and running, and probes and control plane packets are being transmitted. • Blinking green—A Controller connection is in the process of being established. • Solid red—Controller or CA has rejected this appliance, there is a certificate mismatch, or the appliance is unreachable. • Blinking red—Controller is unreachable or unresponsive.
Cloud	Green, Red	Currently not supported.
Wireless	White	<ul style="list-style-type: none"> • Off—Wireless module is not installed. • Solid white—Wireless module is up and running. • Blinking white—Wireless module is booting.
LTE	White	<ul style="list-style-type: none"> • Off—LTE module not installed or not connected. • Solid white—LTE module is up and running. • Blinking white—LTE module is connecting.
Bluetooth	Blue	<ul style="list-style-type: none"> • Off—Bluetooth module is not installed or services are not running. • Solid blue—Bluetooth service is started and advertised.

Power Button

The Power button on the rear panel of a CSG700 series appliance turns the power on and off.

To turn the power on, press and immediately release the Power button when the appliance is off.

To turn the power off, press the Power button when the appliance is on, as follows:

- If you press and immediately release the button, the appliance does a graceful software shutdown that is equivalent to issuing the **shutdown now** command from the operating system shell.

https://docs.versa-networks.com/Hardware/Cloud_Services_Gateway_700_Series/Complete_CSG700_Series_Hardware_Gui...

Updated: Tue, 18 Oct 2022 06:10:27 GMT

Copyright © 2021, Versa Networks, Inc.

- If you press and hold the button for 10 seconds or more, the power for the appliance turns off and the appliance shuts down.

Reset Button

The Reset button on the rear panel of a CSG700 series appliance resets the appliance. The reset functionality depends on the number of times you press the button within a span of 30 seconds, as described in Table 3. In between each press on the reset button, you must pause for a second to register the key presses.

The Reset button is recessed so that it is not accidentally pressed while the appliance is operational.

To press the Reset button, use a sharp narrow tool. Each time you press the Reset button, you hear a buzzer sound.

Table 3: Reset Button Press Behavior

Number of Presses	Behavior
2	Reset the appliance to the factory-default snapshot.
4	Reset the appliance to the branch prestaging configuration.
6	Reset the appliance to the branch staging configuration.
8	Reset the appliance to branch post-staging configuration.

You can reset the appliance to the factory-default configuration by issuing the **request system reset** CLI command.

Reset the Appliance to the Factory-Default Configuration from the CLI

You can reset the appliance to the factory-default configuration from the CLI. You can connect to the appliance through the serial console port or by using SSH.

The factory default reset procedure may take up to 20 minutes to complete. Do not power off the appliance during this time.

To reset an appliance to the factory default configuration:

1. To connect to the appliance through the serial console port, see [Configure a Management Console to Connect to a CSG700 Series Appliance](#).
2. Log in to the appliance CLI using the username "admin" and the password "versa123".

Note: To connect to the appliance using SSH, connect your PC to the management port of the appliance. For the port mapping on the CSG700 series appliance, see [Interface Numbering](#). The management port has the default static IP address 10.10.10.10/24. Configure the PC IP address to any IP from this segment, for example, 10.10.10.1/24. Open an SSH session to the appliance using its IP address, 10.10.10.10.

- Issue the following commands to reset the configuration to factory default. If the current software version on the appliance is the same as that of the factory reset snapshot, the procedure takes about 10 minutes to complete. If the software versions are different, the procedure takes about 20 minutes to complete. Do not power off the appliance during the process.

```
% cli
% request system reset
```

- Verify that all Versa services are running by issuing the **vsh status** command from the Linux bash CLI. The following is a sample output of this command. If all the services are shown as stopped, issue the **vsh start** command from the Linux bash CLI to start them manually.

```
# vsh status
versa-service is Running, [*] process 6784
versa-infmgr is Running, [-] process 5623
versa-rfd is Running, [-] process 5838
versa-vmod is Running, [-] process 5839
versa-ip2user is Running, [-] process 5844
versa-imgr is Running, [-] process 5848
versa-acctmgrd is Running, [-] process 5845
versa-fltrmgr is Running, [-] process 5648
versa-vstated is Running, [-] process 5625
versa-addrmgrd is Running, [-] process 5857
versa-rt-cli-xfm is Running, [-] process 5798
versa-rt is Running, [-] process 5827
versa-dhcpd is Running, [-] process 5620
versa-eventd is Running, [-] process 5843
versa-rrpd is Running, [-] process 5643
versa-dnsd is Running, [-] process 5646
versa-ppmd is Running, [-] process 5793
versa-snmp-xform is Running, [-] process 5800
versa-certd is Running, [-] process 5849
versa-ntpd is Running, [*] process 5612
versa-dhclient6 is Running, [-] process 5807
versa-redis is Running,[-] process 6927
versa-av-redis is Running, [-] process 5003
versa-spackmgr is Running, [-] process 5832
versa-monit is Running, [*] process 6078
versa-confd is Running, [*] process 4798
versa-fail2ban is Running, [*] process 6093
versa-auditd is Running, [*] process 6116
versa-nodejs is Running, [-] process 5775
```

- Power off the appliance.

Kensington Security Lock

The Kensington security lock on the rear panel of a CSG700 series appliance is a small metal-enforced hole for attaching a Kensington lock to secure the appliance.

GPS Input

The GPS antenna input on the rear panel of a CSG700 series appliance allows you to connect an external GPS antenna. When you connect a GPS antenna to the appliance, it automatically identifies the geographical location of the unit, allowing you to detect any theft or movement of the appliance. Knowing the precise location of the unit also enables Versa Director to provision devices when the serial number is not mandated for the zero-touch provisioning (ZTP) process.

Additional Information

[Factory Default Settings for Branch Devices](#)

Network Interface Cards

The Cloud Services Gateway (CSG) 700 series appliances offer field configurability using the network interface card (NIC) slot.

NIC Types

Table1 describe the NIC types and models.

Table 1: CSG750 and CSG770 NIC Support

NIC Type and Model	NIC Options	Description
Gigabit Ethernet		
• NIC-4GP	4-port copper Gigabit Ethernet PoE/PoE+ NIC, 60 W	<ul style="list-style-type: none"> Support IEEE 802.3af Type 1 PoE and IEEE 802.3at Type 2 PoE+ devices. Each port can supply up to 30 W of power, with a maximum of 60 W for the module.
• NIC-4GP-120 W	4-port copper Gigabit Ethernet PoE/PoE+NIC, 120 W	<ul style="list-style-type: none"> Support IEEE 802.3af Type 1 PoE and IEEE 802.3at Type 2 PoE+ devices 802.3at-2009 Type 2 (PoE+) Class 4 Each port can supply up to 30 W of power, with a maximum of 120 W for the module.
• NIC-8GE	8-port copper Gigabit Ethernet copper	<ul style="list-style-type: none"> Supports 10/100/1000BASE-T
ADSL+/VDSL		
• NIC-1VA	1 RJ45 port ADSL+/VDSL, Annex A	<ul style="list-style-type: none"> Single-port ADSL+/VDSL module that supports Annex A (POTS)
• NIC-1VB	1 RJ45 port ADSL+/VDSL, Annex B	<ul style="list-style-type: none"> Single-port ADSL+/VDSL module that supports Annex B (ISDN)
T1/E1		
• NIC-4DS	4-port T1/E1	<ul style="list-style-type: none"> Supports T1/E1 framing Supports all common formats Supports PPP, HDLC, and Frame Relay encapsulations.
• NIC-4GF	4-port Gigabit Ethernet SFP	Supports fiber Gigabit Ethernet for 1000BASE-SX and 1000BASE-LX.

The four Ethernet ports on the NIC are labeled Port 6 through Port 9.

https://docs.versa-networks.com/Hardware/Cloud_Services_Gateway_700_Series/Complete_CSG700_Series_Hardware_Gui...

Updated: Tue, 18 Oct 2022 06:10:27 GMT

Copyright © 2021, Versa Networks, Inc.

The CSG700 series appliance NICs are not field installable.

Figure 1 shows the four RJ-45 connectors for the four Ethernet ports. (1 GbE port and for the 1 GbE with PoE port.)

Figure 1: RJ-45 Connectors for 1 GbE Port with or without PoE Port

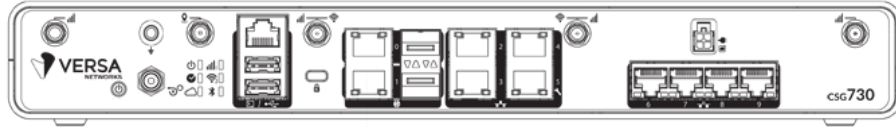
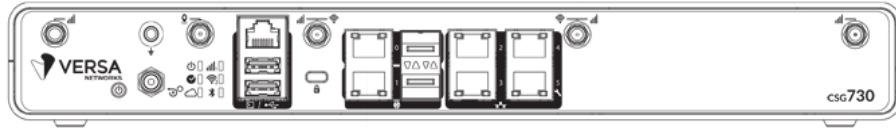

Figure 2 shows the four RJ-45 connectors/SFP slots for the 1 GbE /SFP combination port.

Figure 2: RJ-45 Connectors or SFP Slots for 1 GbE /SFP Combination Port



NIC Specifications

Table 3 lists the NIC specifications for a CSG700 series chassis.

Table 3: CSG700 Series NIC Specifications

Item	Specification
Item Specification	
Typical power consumption	10 Watts
System power input	3.3 VDC @ 3A
PoE power adapter input	54 VDC @ 2.78 A, 100-240 VAC @ 2A, 50-60 Hz
Physical Specifications	
Height	1.54" (39 mm)
Width	3.25" (82.5 mm)
Depth	5.52" (140 mm)

Item	Specification
Weight	
• NIC-8GE	0.33 lb (150 gm)
• NIC-4GP-120 W	0.44 lb (200 gm)
• NIC-1VA/1VB	0.33 lb (150 gm)
• NIC-4DS	0.44 lb (200 gm)
• NIC-4GF	0.33 lb (150 gm)
Package Specifications	
Package height	3.25" (82.55 mm)
Package width	6" (152.4 mm)
Package depth	9" (228.6 mm)
Package weight	0.77 lb (350 gm)
Operating Conditions	
Temperature	0 to 40°C (32 to 104°F)
Humidity	10 to 85% relative humidity
Altitude	Maximum 3000 m (10000 ft)
Noise level	0 dBm
Storage Conditions	
Temperature	-20 to 70°C (-4 to 158°F) at sea level

Item	Specification
Humidity	10 to 85% relative humidity

LTE Modem Module

The CSG700 series LTE modem module is a high-performance Cat-6 LTE Advanced modem that provides up to 300 Mbps download speeds and 50 Mbps upload speeds. The LTE modem supports multiple carriers, and it has been certified by major global carriers. The modem has a single SIM card that is externally accessible.

The LTE firmware-driven modem module provides the following capabilities:

- Externally accessible SIM card that supports dual-LTE modems.
- Connects to most global carrier's network based on the SIM card inserted.
- Global navigation satellite system (GNSS) receiver enables tracking and location-based services.
- Stores up to three firmware versions, thereby allowing the modem to switch to other networks.
- Firmware can be upgraded over the air
- Secure boot provides secure connectivity by preventing unauthorized code on target devices.

The LTE modem connections are metered connections, and the Versa software implementation ensures that the LTE service is charged only when needed. Policies and scenarios that determine the use of LTE interfaces are set by network operators and implemented using Versa Operating System™ (VOS™) software.

Table 1 lists the supported LTE specifications.

Table 1: LTE Specifications

Specification	APAC Modem	Americas and EMEA Modem
Peak download/ upload rate	300/50 Mbps	300/50 Mbps
Frequency bands 4GLTE	1, 3, 5, 7, 8, 18, 19, 21, 28, 38, 39, 40, and 41	1 through 5, 7, 8, 12, 13, 20, 25, 26, 29, 30, and 41
Frequency bands 3G WCDMA	1, 5, 6, 8, 9, and 19	1, 2, 3, 4, 5, 8
Supported carrier aggregation	1 + (8, 18, 19, 21), 3 + (5, 7, 19, 28), 7 + (5, 7, 28), 19 + 21, 38 + 38, 39 + 39, 40 + 40, and 41 + 41	1 + 8, 2 + (2, 5, 12, 13, 29), 3 + (7, 20), 4 + (4, 5, 12, 13, 29), 7 + (7, 20), 12 + 30, 5 + 30, and 41+41

Specification	APAC Modem	Americas and EMEA Modem
Location Solution	Standalone, Xtra, SUPL 1.0 & 2.0, GLONASS, Galileo, BeiDou	Standalone, Xtra, SUPL 1.0 & 2.0, GLONASS, Galileo, BeiDou
Approvals	CE, GCF, JRF/JPA, KC, NCC	CE, FCC, GCF, IC, NCC, PTCRB
Certified Carriers	NTT Docomo, Telstra, KDDI, Softbank	AT&T, Bell, Rogers, Sprint, Telus, Verizon, Vodafone, US Cellular, Anatel

You can order CSG 700 series appliances with an optional LTE modem module. The LTE modem modules have either one SIM slot or two SIM slots. For modules with one SIM slot, you insert the SIM card into the SIM1 slot, which is on the front of the appliance. For modules with two SIM slots, you insert a SIM card into each of the two SIM slots, which are labeled SIM1 and SIM2.

Note: If the appliance has two SIM card slots, use SIM slot 1 and vni-0/100 port for bootstrapping when you upgrade the software to a later version.

If the appliance is off when you insert the SIM card or cards, the LTE functionality is activated when you boot the appliance. If you insert the SIM card or cards into the LTE modem module when the appliance is on and operational, you must reboot the appliance to restart the LTE modem and LTE functionality. To do this, you must power off the appliance, unplug the power cable, plug the power cable back in, and press the power button. Simply powering the appliance on and off does not restart the LTE modem. Also, pressing the reset button on the appliance or rebooting the appliance from Versa Director does not restart the LTE modem.

WiFi Access Point Module

You can order the CSG700 series appliance with the WiFi access point (AP) module. If you do so, the WiFi AP module comes preinstalled in the SIM 2 slot on the front of the appliance.

The WiFi AP module is a dual-band module that simultaneously supports 2.4 GHz, for longer distances, and 5 GHz, for faster throughput. It provides the following WiFi capabilities:

- WiFi radios preconfigured for 2.4-GHz or 5.0-GHz operation
- Supports DFS frequency bands, enabled by default, thereby providing more frequency bands for 5-GHz radio
- Supports 802.11ac Wave 2 standard and 2x2:2 Multi User Multiple Input Multiple Output (MU-MIMO) for more efficient transmission to multiple clients
- Built-in support for WiFi mesh capabilities
- Supports IEEE 802.11a, 802.11b, 802.11g, 802.11n, and 802.11ac protocols
- Supports channel bandwidth of 20 MHz, 40 MHz, and 80 MHz
- Supports channel bonding with channel bandwidths of 5 MHz, 10 MHz, 20 MHz, and 40 MHz

https://docs.versa-networks.com/Hardware/Cloud_Services_Gateway_700_Series/Complete_CSG700_Series_Hardware_Gui...

Updated: Tue, 18 Oct 2022 06:10:27 GMT

Copyright © 2021, Versa Networks, Inc.

- Background scanning automatically selects the best and cleanest channel
- Supports up to 512 concurrent clients across both frequencies, while each radio supports up to 256 clients
- Supports up to 16 SSIDs simultaneously
- Supports client steering capabilities across respective frequency bands based on load and number of clients in each frequency thereby allowing end devices to have optimum experience
- Certified for FCC and CE

The WiFi AP module has a hardware-based cryptographic engine that includes secure boot. WiFi security is provided by 802.11i, AES-CCMP, AES-GCMP, PRNG, TKIP, WAPI, WEP, WPA, WPA2, and WPS based encryption methods.

You can seamlessly integrate the WiFi AP module with Versa Operating System™ (VOS™) features, including over-the-air traffic analysis and other analytics. The VOS software provides queuing mechanisms, including weighted round-robin (WRR). In addition, the WiFi AP module has a built-in QoS feature that prioritizes and manages over-the-air traffic. It also has built-in spectrum analyzer capabilities to detect rogue frequencies in an environment, if desired.

Interface Numbering

Figure 1 shows the mapping of the Ethernet ports to Virtual Network Interface (VNI) numbering for the CSG700 series appliances.

Figure 3: Port-to-VNI Mapping

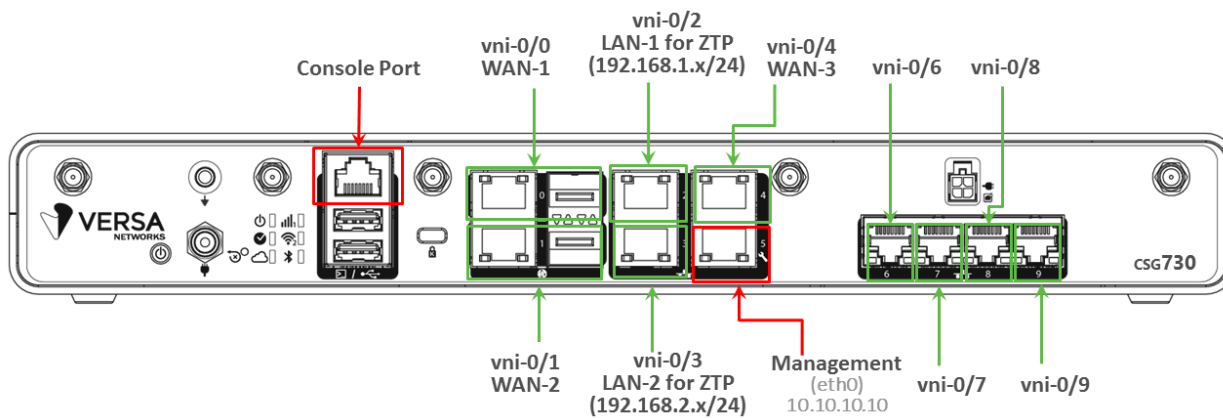

Power Supply and Airflow

This article describes the AC power supply and airflow requirements for CSG700 appliances.

AC Power Supply

By default, CSG700 series appliances ship with one AC power supply unit.

If you order the CSG700 series appliance with the power over Ethernet (PoE) NIC module, an additional power supply unit ships with the appliance.

Table 1 describes the AC power supply specifications for each power supply unit.

Table 1: CSG700 AC Power Supply Specifications

Item	Specification
AC input voltage	100–240 Volts
AC input line frequency	50–60 Hz
Typical power consumption with PoE disabled	35 Watts
Typical power consumption with PoE enabled	60 Watts

Airflow Requirements

The CSG700 series appliance is made of aluminum for optimal heat dissipation.

The appliance has no fans, to minimize noise and to maximize the life of the appliance. Cooling occurs by natural airflow through the vents on the top of the appliance.

When planning your site for installing a CSG700 series appliance in a 19-inch rack, allow a minimum of 0.5 RU space above the appliance to allow hot air to flow out of the appliance. However, it is recommended that you allow 1 RU space above the appliance for cooling.

When placing a CSG700 series appliance on a desk, ensure that the vents on the top of the unit are never blocked, to allow hot air to flow out of the appliance. Covering the vents prevents heat from dissipating out of the appliance, which will cause the chassis to overheat and then shut down.

This article lists the small form-factor pluggable (SFP/SFP+) optics supported on the CSG700 series appliance fiber interfaces, and it describes the remote switches that have been tested with the SFPs.

Supported 1-Gigabit Ethernet SFP Transceivers

The following table describes the 1-Gigabit Ethernet SFP transceiver modules supported on the CSG700 series appliances.

Type	Manufacturer	Part Number	Transceiver Description
Short reach (SR)	Finisar	FTLF8519P3BNL	1000BASE-SX Ethernet SFP optical transceiver, 500-m extended temperature
Long	Finisar	FTLF1318P3BTL	1000BASE-LX Ethernet Gen 3 SFP optical transceiver, 10-km

https://docs.versa-networks.com/Hardware/Cloud_Services_Gateway_700_Series/Complete_CSG700_Series_Hardware_Gui...

Updated: Tue, 18 Oct 2022 06:10:27 GMT

Copyright © 2021, Versa Networks, Inc.

Type	Manufacturer	Part Number	Transceiver Description
reach (LR)			industrial operating temperature

Compatible Remote Switches

The following switches have been tested with a 1-Gigabit Ethernet link connection to CSG700 series appliances:

- Cisco Nexus 3048T
- Dell S3048 and S4128F
- Juniper EX2200

Connection Recommendations

The following are recommendations for connecting at 1-Gigabit Ethernet speeds:

- After you dynamically insert an SFP or change the SFP speed, you must disable and then reenable the VNI interface on the CSG700 appliance.
- If the configuration on the remote device changes, you must disable and then re-enable the VNI interface on the CSG700 appliance.
- Ensure that you have enabled the 1-Gigabit Ethernet interface in the Versa Operating System™ (VOS™) software.
- For 1-Gigabit Ethernet SFPs, you must turn off autonegotiation on the remote device, and you must set the connection speed 1-GE. For example, for Cisco switches, in the interface configuration, configure the speed to 1000:

```
interface Ethernet 1/25
speed 1000
```

For Juniper switches, configure no-auto-negotiation on the interface:

```
enable;
ether-options {
  no-auto-negotiation;
  link-mode full-duplex;
  speed {
    1g;
  }
}
```

Note: Before you order units in bulk, validate connections with the target remote device in a lab or testing environment to ensure that there are no compatibility or link issues.

Compatibility Issues

- Link flap issues may occur if the remote device is an older Cisco Nexus 3064 switch (2012).
- After you reboot CSG700 appliances, the link error "DCX-NO Ack in 100 PDUs" may occur on Cisco Nexus switches. As a workaround, issue the **shutdown** command followed by a **no shutdown** on the Cisco switch interface that is used for link detection.
- BASE-T SFP modules for Denver-based boards are not supported.

Installation Guidelines

This article provides general safety standards and warnings relating to installing or connecting a CSG700 series appliance.

General Safety Guidelines

Caution: Before installing or removing a CSG700 series appliance, ensure that the appliance chassis is electrically connected to ground. When you are installing or removing an appliance, ensure that you wear an ESD grounding wrist strap. To put the ESD grounding strap on properly, attach it to an ESD point and then place the other end of the strap around your bare wrist, making good skin contact. Failure to use an ESD grounding strap could damage the appliance.

- Install the CSG700 series appliance in compliance with the following local, national, and international electrical codes:
 - United States—National Fire Protection Association (NFPA 70), United States National Electrical Code.
 - Other countries—International Electromechanical Commission (IEC) 60364, Part 1 through Part 7.
 - Evaluated to the TN power system.
 - Canada—Canadian Electrical Code, Part 1, CSA C22.1.
- Locate the emergency power-off switch in the installation area. In case of an electrical accident, turn off the power quickly.
- Disconnect power to the appliance before installing or removing it.
- Disconnect power from the circuit that is being used for the appliance.
- If hazardous conditions exist, do not work alone.
- If you are working under conditions that might be hazardous to the eyes, wear safety glasses or goggles.

Federal Communication Commission Interference Statement

This device complies with Part 15 of the FCC Rules. Operation is subject to the following two conditions: (1) This device may not cause harmful interference, and (2) this device must accept any interference received, including interference that may cause undesired operation.

This equipment has been tested and found to comply with the limits for a Class A digital device, pursuant to part 15 of the FCC Rules. These limits are designed to provide reasonable protection against harmful interference when the equipment is operated in a commercial environment. This equipment generates, uses, and can radiate radio frequency energy and, if not installed and used in accordance with the instruction manual, may cause harmful interference to radio communications. Operation of this equipment in a residential area is likely to cause harmful interference in which case the user will be required to correct the interference at his own expense.

FCC Caution: Any changes or modifications not expressly approved by the party responsible for compliance could void the user's authority to operate this equipment.

This transmitter must not be collocated or operating in conjunction with any other antenna or transmitter.

Radiation Exposure Statement

This equipment complies with FCC radiation exposure limits set forth for an uncontrolled environment. This equipment should be installed and operated with minimum distance 20 cm between the radiator and your body.

ANATEL Interference Statement for Brazil

The following ANATEL interference information applies to Brazil only:

Este equipamento não tem direito à proteção contra interferência prejudicial e não pode causar interferência em sistemas devidamente autorizados. Para maiores informações, consulte o site da ANATEL, www.anatel.gov.br.

IC Wireless Interference Statement for Canada

The following IC wireless interference information applies to Canada only:

This series appliance contains licence-exempt transmitters or receivers that comply with Innovation, Science, and Economic Development Canada's licence-exempt RSSs. Operation is subject to the following conditions:

1. This device may not cause interference.
2. This device must accept any interference, including interference that may cause undesired operation of the device.

L'émetteur/récepteur exempt de licence contenu dans le présent appareil est conforme aux CNR d'Innovation, Sciences et Développement économique Canada applicables aux appareils radio exempts de licence. L'exploitation est autorisée aux deux conditions suivantes:

1. L'appareil ne doit pas produire de brouillage.
2. L'appareil doit accepter tout brouillage radioélectrique subi, même si le brouillage est susceptible d'en

https://docs.versa-networks.com/Hardware/Cloud_Services_Gateway_700_Series/Complete_CSG700_Series_Hardware_Gui...

Updated: Tue, 18 Oct 2022 06:10:27 GMT

Copyright © 2021, Versa Networks, Inc.

compromettre le fonctionnement.

To satisfy RF exposure requirements, a separation distance of 20 cm or more must be maintained between the antenna of CSG700 series device and persons during device operation. To ensure compliance, operations at closer than this distance is not recommended.

Les antennes installées doivent être situées de façon à ce que la population ne puisse y être exposée à une distance de moins de 20 cm. Installer les antennes de façon à ce que le personnel ne puisse approcher à 20 cm ou moins de la position centrale de l'antenne.

These radio transmitters IC:2417C-MC7455 and 26338-CSGW1 have been approved by Innovation, Science, and Economic Development Canada to operate with the antenna types listed below with the maximum permissible gain indicated. Antenna types not included in this list that have a gain greater than the maximum gain indicated for any type listed are strictly prohibited for use with this device.

- LTE MC7455 modules—Radio transmitter IC: 2417C-MC7455
 - Gain of antenna: 4.16 dBi maximum
 - Type of antenna: 50 ohm, dipole
- WiFi CSG-W1 modules—Radio transmitter IC: 26338-CSGW1
 - Gain of antenna: 4.55 dBi maximum
 - Type of antenna: 50 ohm, dipole

Le présent émetteur radio IC:2417C-MC7455 and 26338-CSGW1 a été approuvé par Innovation, Sciences et Développement économique Canada pour fonctionner avec les types d'antenne énumérés ci-dessous et ayant un gain admissible maximal. Les types d'antenne non inclus dans cette liste, et dont le gain est supérieur au gain maximal indiqué pour tout type figurant sur la liste, sont strictement interdits pour l'exploitation de l'émetteur.

- LTE MC7455 modules—Radio émetteur IC:2417C-MC7455
 - Gain d'antenne: 4.16 dBi maximal
 - Type d'antenne: 50 ohm, dipole
- WiFi CSG-W1 modules—Radio émetteur IC:26338-CSGW1
 - Gain d'antenne: 4.55 dBi maximal
 - Type d'antenne: 50 ohm, dipole
- The device for operation in the band 5150–5250 MHz is only for indoor use to reduce the potential for harmful interference to co-channel mobile satellite systems.
Les dispositifs fonctionnant dans la bande de 5 150 à 5 250 MHz sont réservés uniquement pour une utilisation à l'intérieur afin de réduire les risques de brouillage préjudiciable aux systèmes de satellites mobiles utilisant les mêmes canaux.
- For devices with detachable antennas, the maximum antenna gain permitted for devices in the bands 5250–5350 MHz and 5470–5725 MHz must be such that the equipment still complies with the EIRP limit.
Pour les dispositifs munis d'antennes amovibles, le gain maximal d'antenne permis pour les dispositifs utilisant les bandes de 5 250 à 5 350 MHz et de 5 470 à 5 725 MHz doit être conforme à la limite de la p.i.r.e.
- For devices with detachable antennas, the maximum antenna gain permitted for devices in the band 5725–5850 MHz must be such that the equipment still complies with the EIRP limits as appropriate.
Pour les dispositifs munis d'antennes amovibles, le gain maximal d'antenne permis (pour les dispositifs utilisant la

bande de 5 725 à 5 850 MHz) doit être conforme à la limite de la p.i.r.e. spécifiée pour l'exploitation point à point et l'exploitation non point à point, selon le cas.

- Where applicable, antenna types, antenna models) and worst case tilt angles necessary to remain compliant with the EIRP elevation mask requirement set forth in section 6.2.2.3 must be clearly indicated.
Lorsqu'il y a lieu, les types d'antennes (s'il y en a plusieurs), les numéros de modèle de l'antenne et les pires angles d'inclinaison nécessaires pour rester conforme à l'exigence de la p.i.r.e. applicable au masque d'élévation, énoncée à la section 6.2.2.3, doivent être clairement indiqués.

NBTC Thailand (SDoC) Statement

This telecommunication equipment conforms to the standard or technical requirements of NBTC.

เครื่องโทรคมนาคมและอุปกรณ์นี้ มีความสอดคล้อง ตามมาตรฐานหรือข้อกำหนดทางเทคนิคของ กสทช.

QR Code



Prepare the Site for Installation

To prepare your site for installing a CSG700 series appliance, follow the guidelines and requirements listed in this article.

Site Preparation Guidelines

- Install the appliance in an enclosed and secure environment, and allow only authorized personnel to access the device.
- Keep the area around the appliance free from dust and conductive material.
- Follow ESD prevention procedures to avoid any damage to the appliance.

Environmental Requirements

- Ensure that the area in which you operate the appliance has adequate air circulation so that the cooling system functions normally. Ambient air temperature may not be sufficient to cool the chassis to acceptable operating temperatures without adequate circulation.
- Avoid temperature extremes.
- High humidity conditions can cause moisture to penetrate into the chassis. The appliance can operate in relative humidity of 10% to 85%, non-condensing.

Rack Requirements

You can mount a CSG700 series appliance in a 19-inch four-post rack using slide rails. Table 1 lists the rack requirements.

Table 1: Rack Requirements for a CSG700 Series Appliance

Requirement	Guidelines
Rack type	Use a 19-inch four-post rack that has bracket holes spaced at 1 U (1.75 in. or 4.45 cm) increments, and that has panels strong enough to support the weight of the appliance.
Rack size	Comply with the size and strength standards of a 19-inch rack. Ensure that the rack rails are spaced wide enough to accommodate the external dimensions of the appliance chassis. Ensure that the spacing of rails and the adjacent racks allows for proper clearance around the appliance and the rack.
Rack firmly secured to building structure	Secure the rack to floor brackets and to ceiling brackets to ensure maximum stability.

Airflow Requirements

A CSG700 series appliance has a fanless design and cools by airflow through the vents on the top of the appliance.

When planning your site for installing a CSG700 series appliance in a 19-inch rack, allow a minimum of 0.5 RU space above the appliance to allow hot air to flow out of the appliance. However, it is recommended that you allow 1 RU space above the appliance for cooling.

When placing a CSG700 series appliance on a desk, ensure that the vents on the top of the unit are never blocked, to allow hot air to flow out of the appliance. Covering the vents prevents heat from dissipating out of the appliance, which will cause the chassis to overheat and then shut down.

Install a CSG700 Series Appliance

This article provides instructions about how to unpack a CSG700 series appliance and mount it in a 19-inch rack.

Unpack a CSG700 Series Appliance

The CSG700 series appliance is packed in a plastic box, and it is shipped in a cardboard carton, secured with foam packing material. The carton also contains an accessory box. It is recommended that you unpack the appliance only when you are ready to install it.

To unpack a CSG700 series appliance:

1. Open the top flaps of the cardboard carton.
2. Remove from the box the foam packing material holding the appliance and the accessories in place. See Figure 1.
3. Remove the accessory box and the appliance from the foam packing material.
4. Remove the accessories from the accessories box.
5. Verify the components against the packing list that is included in the box.

Figure 1: Unpack a CSG700 Series Appliance

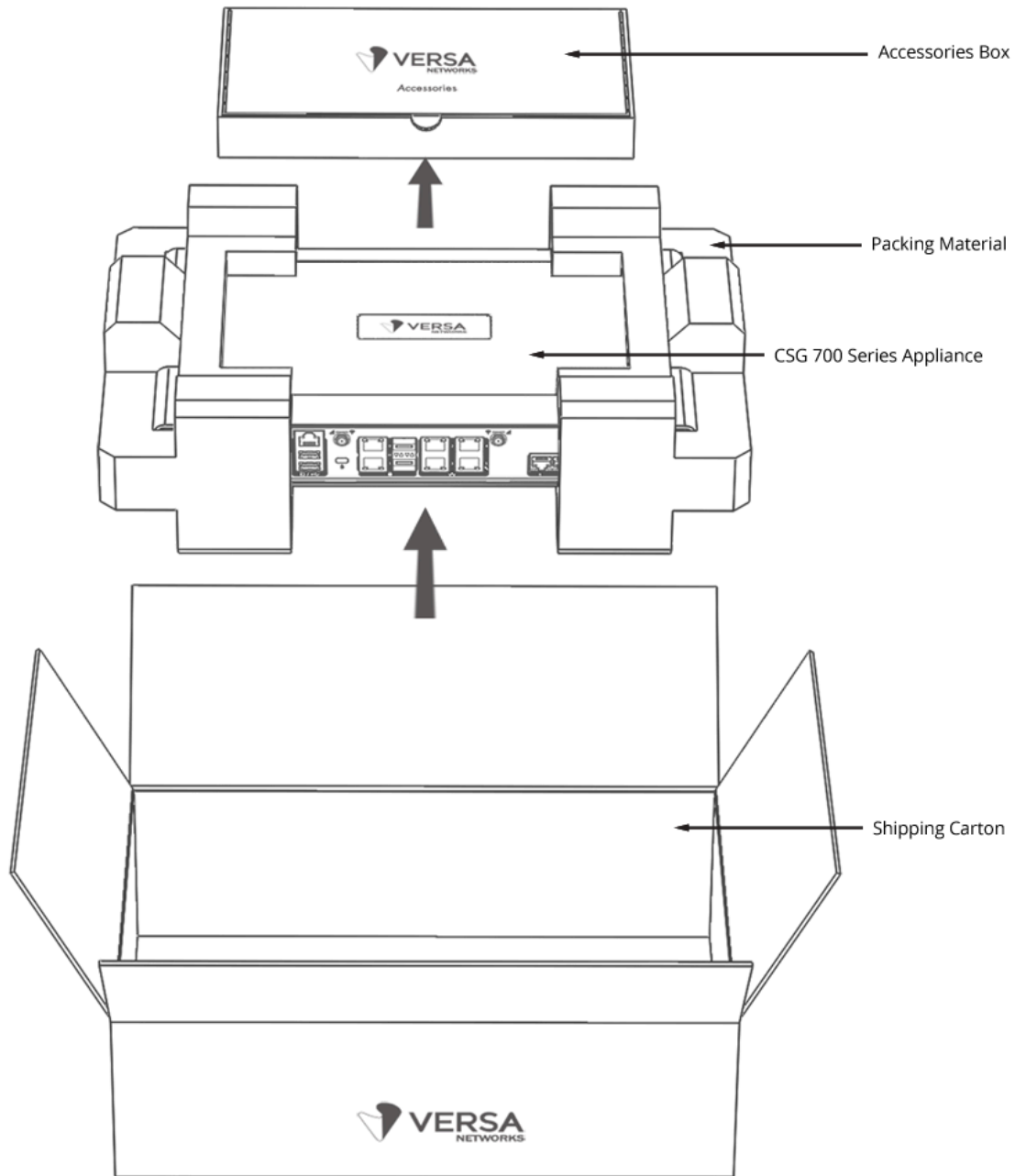

Note: It is recommended that you save the shipping carton and packing material when unpacking the appliance, in case you need to later move the appliance or return it. See [How To Return Hardware](#).

Packing List for a CSG700 Series Appliance

The cardboard carton in which a CSG700 series appliance is shipped contains a packing list. Check the packing list against the parts that you receive in the shipping carton.

https://docs.versa-networks.com/Hardware/Cloud_Services_Gateway_700_Series/Complete_CSG700_Series_Hardware_Gui...

Updated: Tue, 18 Oct 2022 06:10:27 GMT

Copyright © 2021, Versa Networks, Inc.

Packing List for the CSG700 Appliance

Table 1 lists the parts shipped with a CSG700 appliance.

Table 1: Parts Shipped with a CSG700 Series Appliance

Components	Quantity
CSG700 series appliance chassis	1
AC power adapter	1
Standard 3-prong C13 power cable, minimum 2 Amps (US only)	1
65 Watt PoE power adapter (included with PoE NIC module only)	1
Cat 6 cable	1
Cat 5e cable	1
LTE antenna (included with LTE module only)	2 for single LTE module 4 for dual LTE module
WiFi antenna (included with WiFi module only)	2
GPS antenna	1
Rack-mounting ears	2
Screws for rack-mounting ears	6 (size M4)
Screws for rack mounting	4 (size M6)

Mount a CSG700 Series Appliance in a Rack

You can mount a CSG700 series appliance in a 19-inch rack.

To mount the appliance, ensure that you have the following tools:

- Number 2 Phillips (+) screwdriver
- Tape measure

To mount a CSG700 series appliance in a 19-inch rack:

1. Place the appliance chassis on a flat, stable surface.
2. Check the internal dimensions of the rack with a tape measure. The appliance is 22 cm wide (about 8.6 inches wide) and must fit within the mounting posts.

3. Allow a minimum of 0.5 RU space above the appliance for airflow, to allow hot air to flow out. However, it is recommended that you allow 1 RU space above the appliance.

Figure 2: Space a CSG700 Series Appliance when Rack Mounting

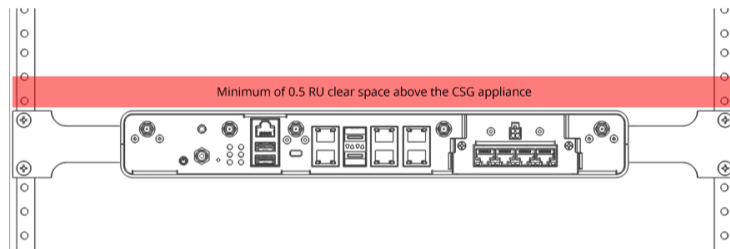

4. Attach the two mounting ears to each side of the appliance chassis using a minimum of six M4 screws that are shipped with the appliance. Do not overtighten the screws.

Figure 3: Attach the Mounting Ears to a CSG700 Series Appliance

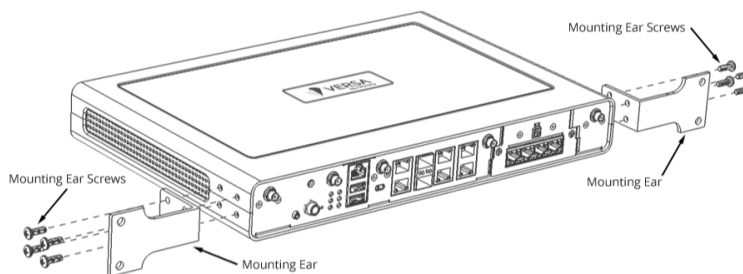

5. Grasp both sides of the appliance chassis, making sure that the front of the chassis is facing you.
6. Stand in front of the rack and lift the chassis. Then, gently insert the chassis into the rack and slide it as far back as possible.

Figure 4: Insert a CSG700 Series Appliance into the Rack

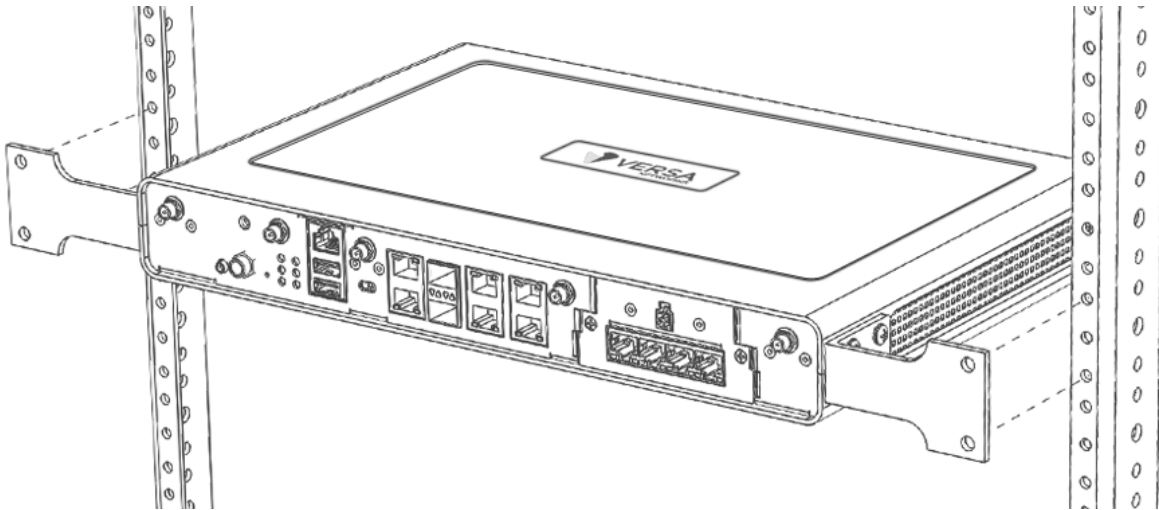

7. Have a second person secure the mounting ears to the front of the rack using the four M6 screws that shipped with the appliance. Insert and then tighten the screws. Do not overtighten the screws.

Figure 5: Secure the Mounting Ears to the Rack

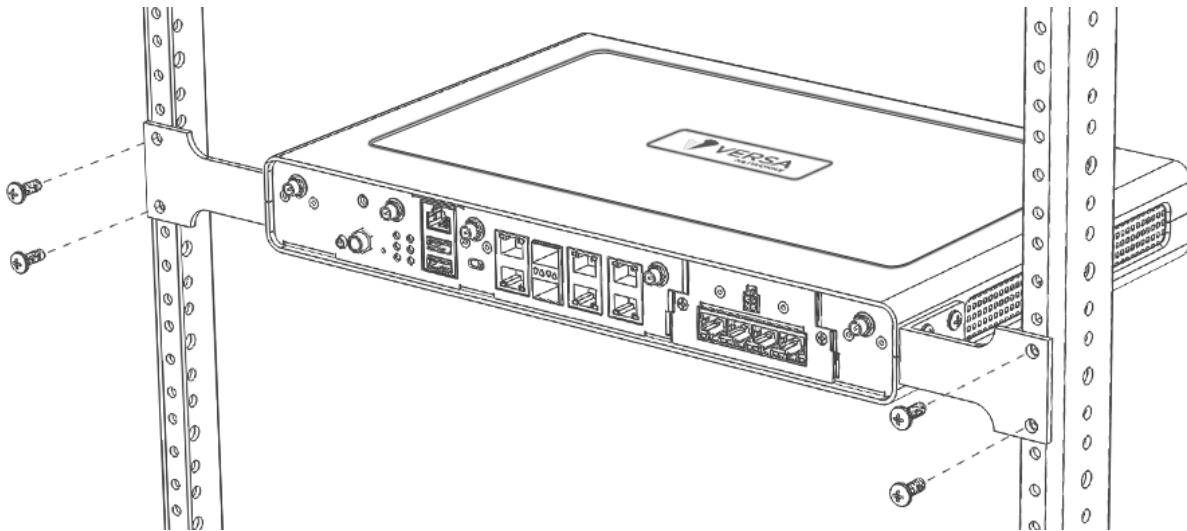

Connect a CSG700 Series Appliance

This article describes how to connect a CSG700 series appliance to an AC power source and to a management console.

Versa recommends an uninterruptible power strategy that prevents power interruptions. A UPS can isolate unpredictable power outages or blackouts, brownouts, lightning, power surges, or spikes.

Step 1: Connect AC Power to a CSG700 Series Appliance

Before you begin connecting AC power to a CSG700 series appliance, ensure that you have:

- Electrostatic discharge (ESD) wrist strap.
- An AC power cord is shipped with the appliances only for U.S. customers. Each power supply has a C13 plug that allows you to plug in standard power cords with C14 termination. The other end of the cord must have appropriate local plug.

To connect a CSG700 series appliance to an AC power source:

1. Attach one end of the ESD grounding strap to your bare wrist, and connect the other end to the ESD point on the rack.
2. Plug one end of the AC power cord into the AC power adapter.



3. Plug the other end of the AC power cord into an AC power source outlet.



4. Plug the DC end of the power supply unit into the back of the CSG700 series appliance.

Step 2: Configure a Management Console to Connect to a CSG700 Series Appliance

CSG700 series appliances are equipped with an RJ45 serial console port and an RJ45 console cable that you use to connect the console port. To communicate with the appliance, you must have a terminal emulation program, such as PuTTY, running on your system.

When you set up the connection, use the following default console port settings:

- Speed (baud): 115200
- Data bits: 8
- Stop bits: 1
- Parity: None
- Flow control: None

To connect a management console to a CSG700 series appliance:

1. Open the PuTTY application. The PuTTY configuration window displays.

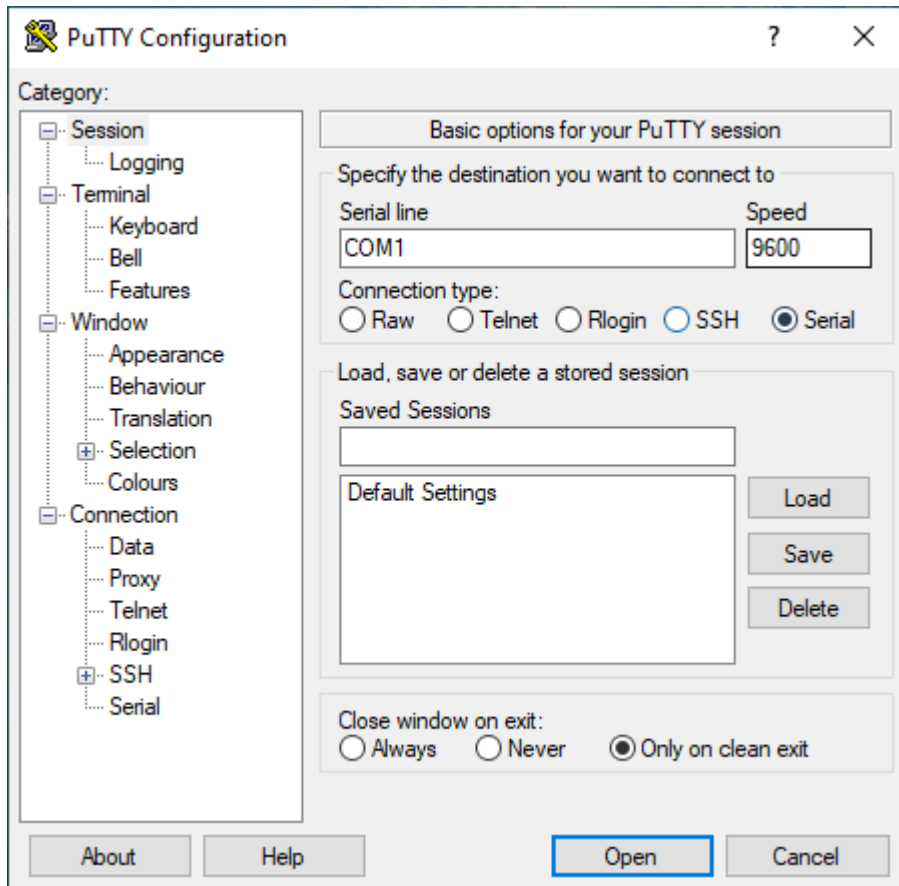

2. In the Category navigation pane, click Session, and then in the Connection Type menu, click Serial.

https://docs.versa-networks.com/Hardware/Cloud_Services_Gateway_700_Series/Complete_CSG700_Series_Hardware_Gui...

Updated: Tue, 18 Oct 2022 06:10:27 GMT

Copyright © 2021, Versa Networks, Inc.

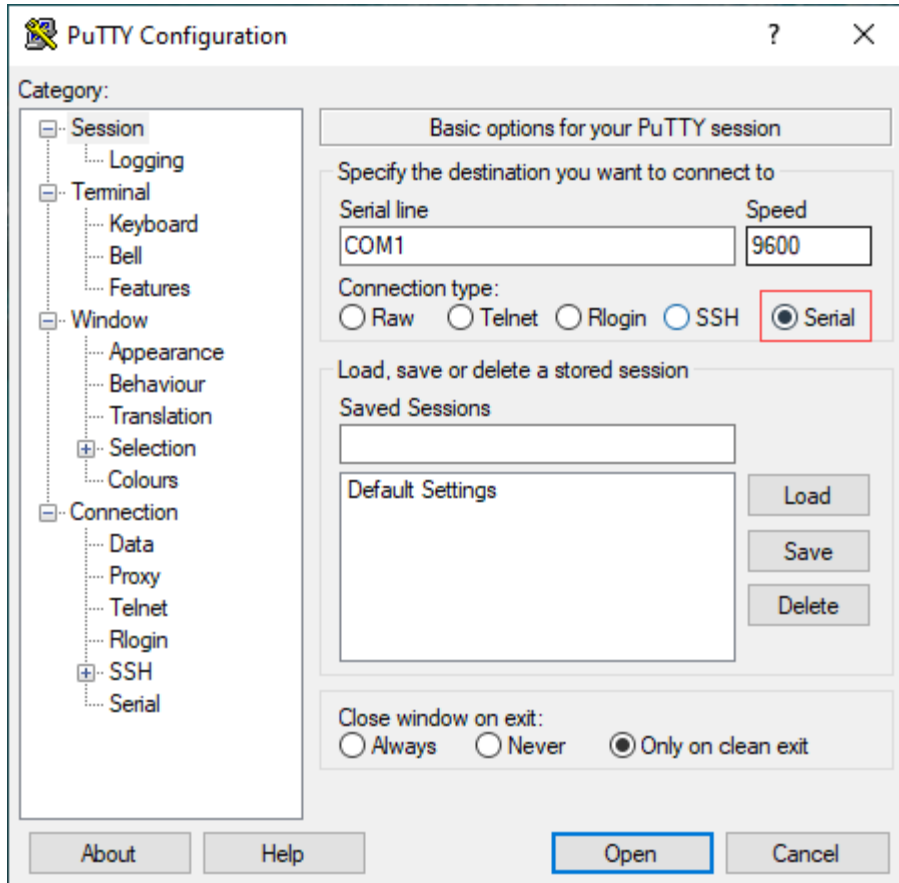

3. In the Category navigation pane, click Connection > Serial. The Options Controlling Local Serial Lines page displays.

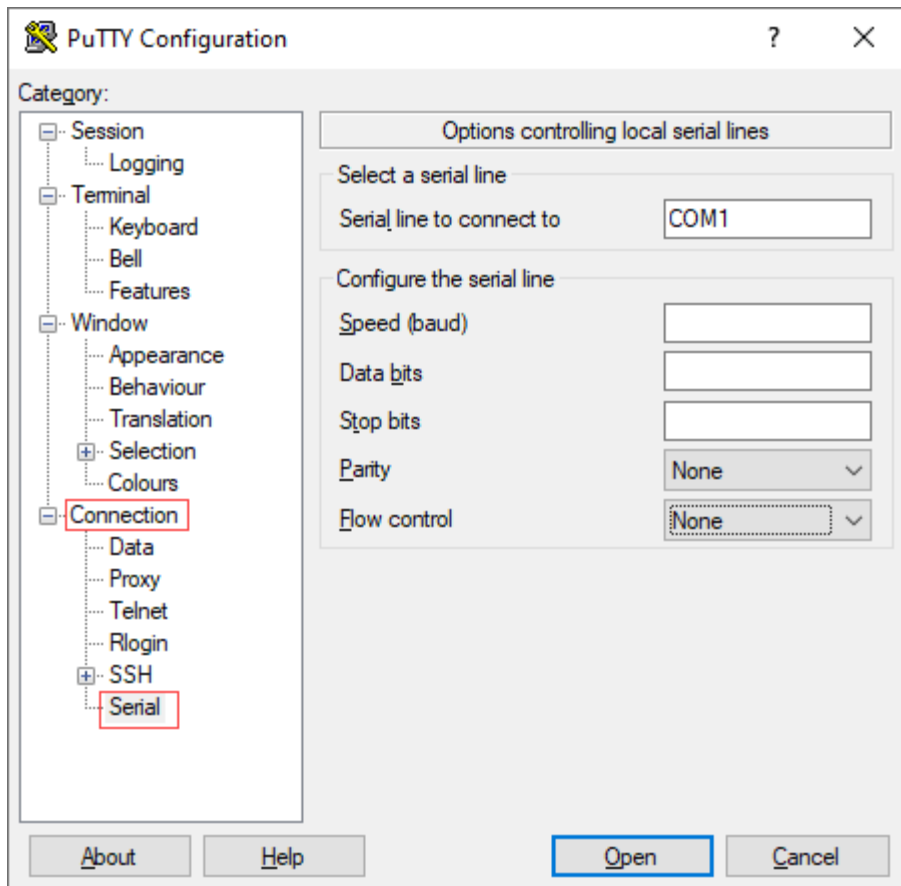

4. In the Serial Line To Connect To field, enter the COM port that your device is connected to. The default COM port is COM1.

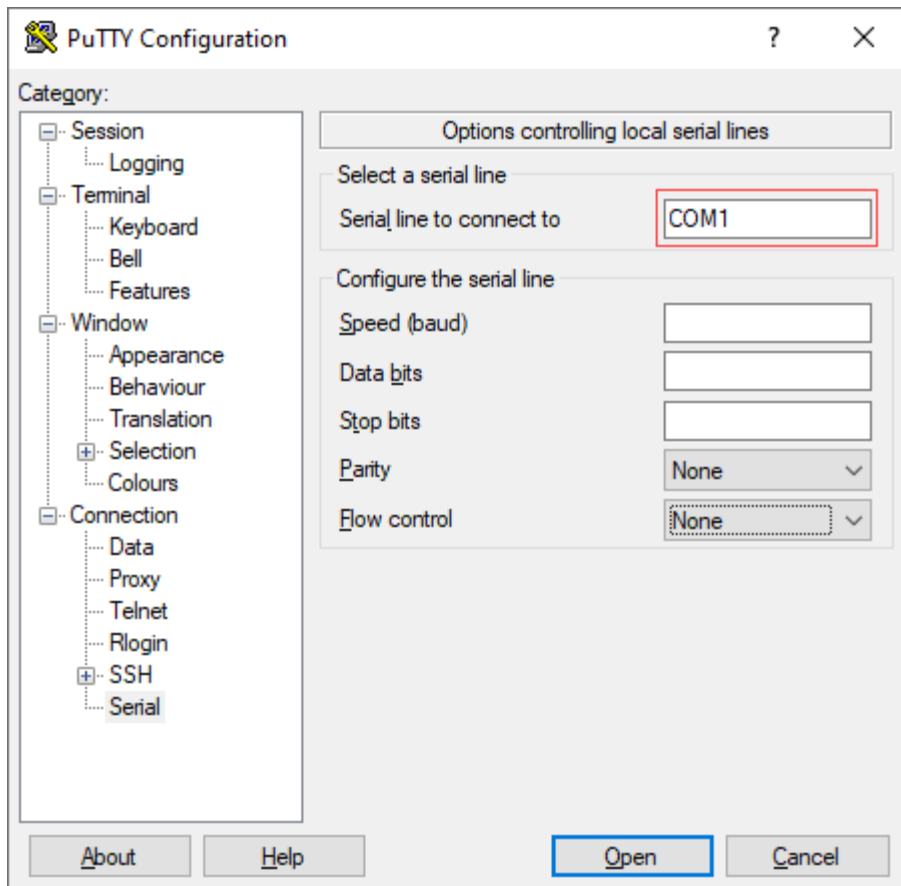

5. In the Configure the Serial Line section, enter the following information.

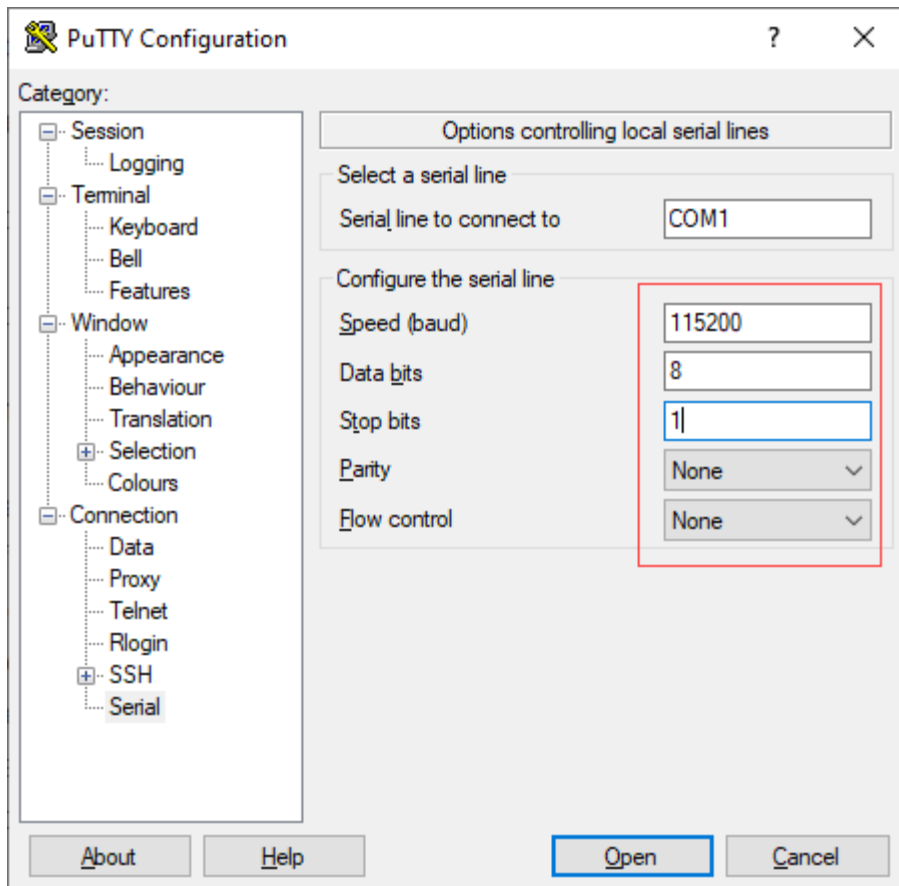

- a. In the Speed (Baud) field, enter the digital transmission speed. For CSG700 series appliances, the speed must be 115200.
 - b. In the Data bits field, enter the number of data bits used for each character. The recommended value is 8.
 - c. In the Stop bits field, enter the number of bits to be sent at the end of every character. The recommended value is 1.
 - d. In the Parity field, select None. This is the method of detecting errors in transmission.
 - e. In the Flow Control field, select None. This is the method of preventing data overflow.
6. Optionally, in the Category navigation pane, click Session, and then in the Saved Sessions field, enter a name to save the session settings.

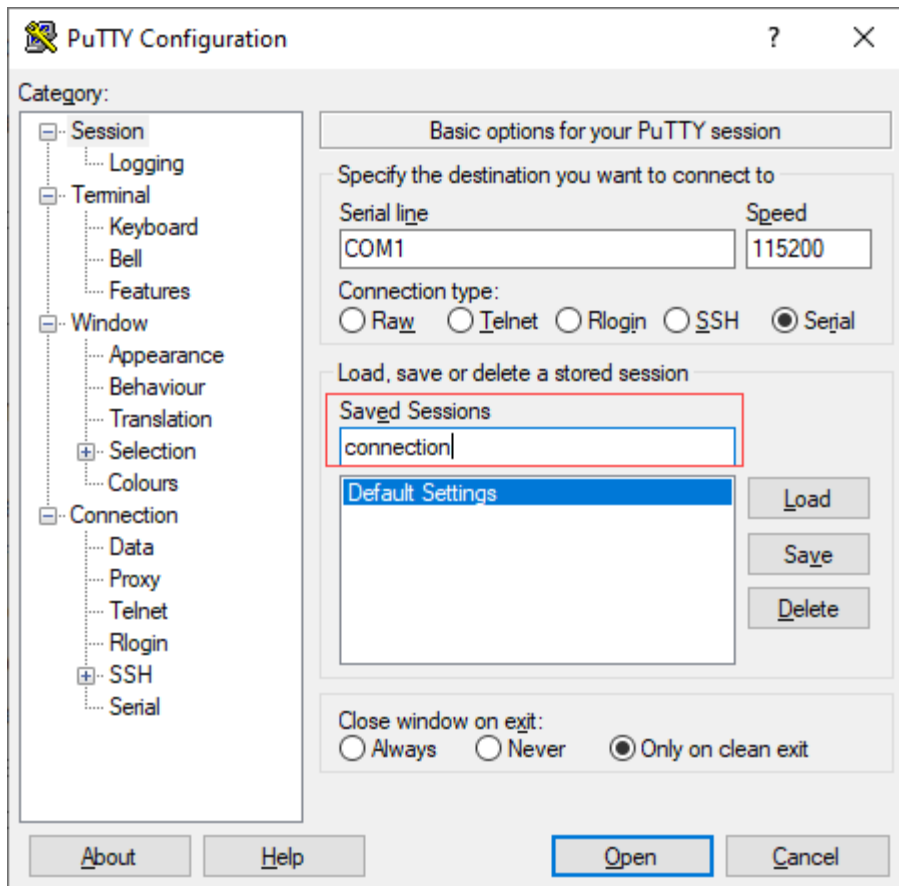

7. Click Save.
8. To open the session, click Open.

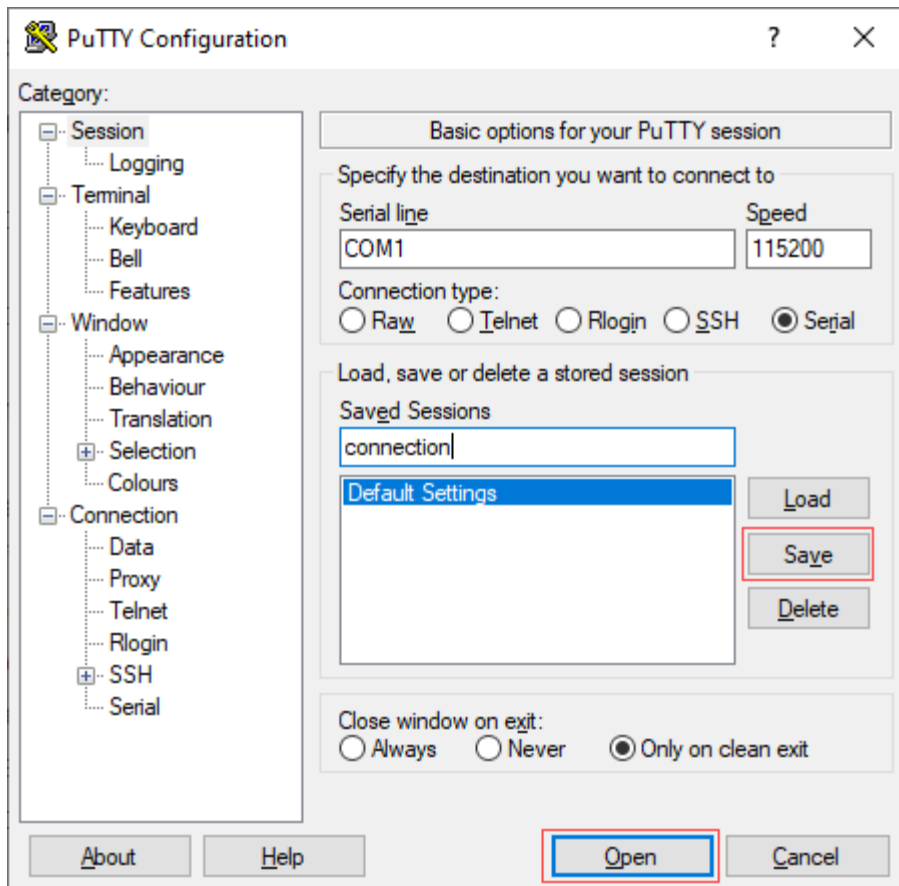

9. Log in to the appliance CLI with the username "admin" and the password "versa123".

