

Natural Gas Detector ML-310CE

User's Manual

This gas detector detects methane gas.

When gas is detected, an alarm (flashing of red LED, sounding of warning alarm) will be activated.

This device is also equipped with an Itron Network Solutions (INS) communication module that can send information over the network regarding gas alarms, gas detector trouble, low battery, and end of service life.

Read, understand and retain this manual for future reference.

Safety Precautions

Read these precautions before using the product and be sure to follow these precautions in order to prevent hazardous situations and property damage.

Precautions are classified with the following symbols according to the severity of the hazards and damage that may arise due to incorrect handling of this product.



This indicates details for which incorrect handling of the product is expected to lead to situations having an imminent chance of hazards leading to death or serious injury.



This indicates details for which incorrect handling of the product is expected to lead to situations having a chance of hazards leading to death or serious injury.



This indicates details for which incorrect handling of the product is expected to lead to situations having a chance of injury or property damage.



Make sure that the following are observed when a gas alarm sounds. There may be a risk of explosion. Leave the building immediately, opening doors and windows as you leave. Take others with you. If you are outside when you smell the gas, leave the area immediately.

Avoid causing a spark, which might cause the gas to explode:

1. Do not remove the connector from the lithium battery
2. Do not light a match or smoke.
3. Do not turn appliances or lights on or off.
4. Do not use a flashlight.
5. Do not start a car.
6. Do not use a telephone.

Find a phone away from the area and immediately call 911 and/or your natural gas utility. You can report leaks anonymously. Always call to report the problem. Do not assume someone else will do it.

Do not re-enter the area until the source of the leak is found and corrected. Follow directions from utility employees or emergency responders who are on site.



- This gas detector is equipped with an End Of Life timer that will expire after 5 years from date of installation. Replace any gas detectors for which 5 years has passed since their installation with a new gas detector.

- Do not subject the gas detector to water either by submerging them in water or spraying water on it.
- Do not disassemble or modify this product.
- Do not subject this product to impacts.
- Do not remove the dedicated lithium battery, except for when disposing of the gas detector.
- Never cover the gas detection unit of this product.
- When removing or installing the gas detector, do so by using a stable ladder or step and proceed with caution.
- Do not change this product's installation position.
- Do not place or install objects in front of the gas detector.
- Do not spray cleaning chemicals or insect sprays directly on or near the detector, as this may cause the detector to malfunction.
- Do not expose this detector to high concentrations of Freon, other CFCs or Volatile Organic Compounds, as over exposure to such substances may cause the detector to malfunction.
- Do not expose this detector to silicones, as over exposure to such substances may cause the detector to malfunction.
- Do not paint over the Alarm. Doing so may permanently damage the detector.



- Do not use this product outside of areas serviced by conEdison.
- Do not listen to alarms with your ear close to the gas detector.
- Do not expose this detector to abnormally strong radio waves/signals, like those emitted from amateur radio equipment, as this may cause the detector to malfunction.

Target Gas

- This gas detector detects methane gas.

Names and Functions of Parts

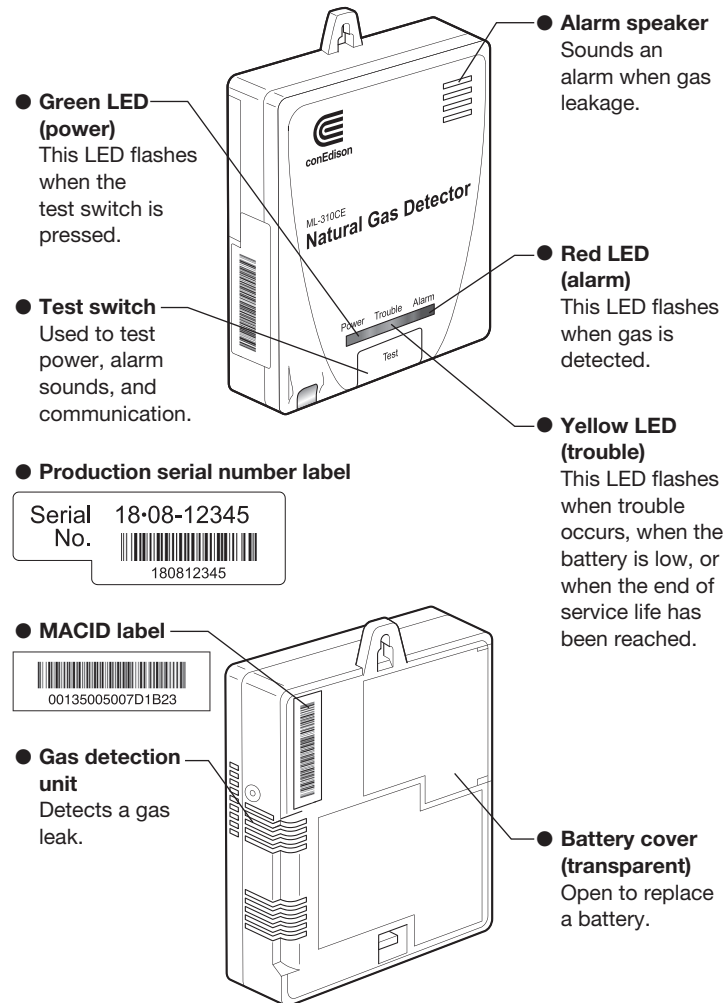

Gas Detector Functions

Visual and audible signals will not stop until the product is reset by removing and reinstalling the battery.

When a gas leak occurs

An alarm sounds when the level of gas in the area of the gas detector reaches or exceeds a certain concentration and warning signals are transmitted.

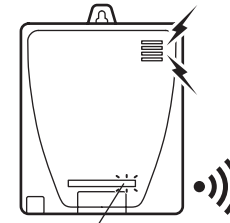

Red LED (alarm)
Flashes once every 2 seconds

An alarm sounds every 6 seconds stating "Beep Beep Beep Beep Danger – gas leak explosion risk – evacuate, then call 911."

Transmits gas alarm signals every 30 seconds.

When trouble occurs

When trouble occurs, Yellow LED (trouble) Flashes 3 times every 10 seconds and trouble signals are transmitted during the health check.

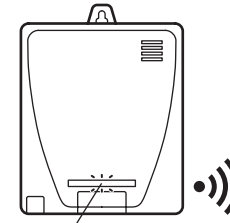

Yellow LED (trouble)
Flashes 3 times every 10 seconds

Transmits trouble signals during health checks performed every 8 hours

When the battery is low

When the battery is low, Yellow LED (trouble) Flashes once every 10 seconds and low battery signals are transmitted during the health check.



Yellow LED (trouble)
Flashes once every 10 seconds

Transmits low battery signals during health checks performed every 8 hours

* Batteries in this device are not available in retail. Please call Consolidated Edison Company for replacement batteries.

When the end of service life is reached

When the end of service life is reached, an end of service life notification is issued and end of service life signals are transmitted during the health check.

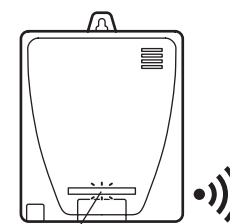

Yellow LED (trouble)
Flashes twice every 10 seconds

Transmits end of service life signals during health checks performed every 8 hours

Usage Instructions

1. Open the battery cover on the back of the gas detector.
2. Connect the included lithium battery.
 - * Once the lithium battery is connected, the gas detector's green LED (power) will flash once for 1 second.
 - The detector will also search for an access point to connect to the network.
3. Insert the lithium battery and close the cover.

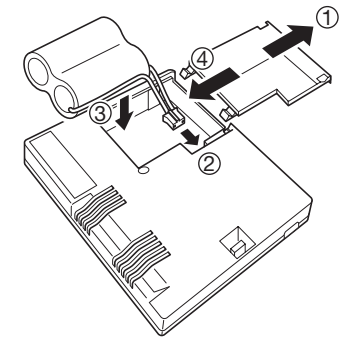

4. A "Beep" will sound 30 seconds after the power is turned on and the detector will begin monitoring.

* The device status will be confirmed during that 30 second period. This "Beep" sound is not a notification that a connection with an access point has been established.

The time required to connect with the access point will depend upon usage conditions. Perform a communication test to confirm the connection status with the access point.

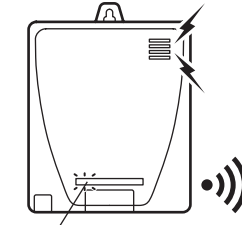

Green LED (power)
Flashes once every second

A "Beep" sounds 30 seconds after power is turned on

Searching for access point

5. Press and hold the Test Switch for more than 3 seconds to test the alarm.

General Maintenance

This detector has been designed to be as maintenance-free as possible, but there are a few simple things you must do to keep it working properly:

- Test it at least once a week.
- Clean the detector at least once a month; gently vacuum the outside of the detector using your household vacuum's soft brush attachment. Test the alarm. Never use water, cleaners or solvents since they may damage the unit.
- Relocate the unit if it sounds frequent unwanted alarms. See "Where This Alarm Should Not Be Installed" for details.
- If product enters low battery mode, the batteries must be replaced. Batteries in this device are not available in retail. Please call Consolidated Edison Company for replacement batteries.

Test Functions

Power check function

A “Beep” sounds when the switch is pushed. If the switch is then released in less than 3 seconds, the green LED will flash twice every second (for 3 seconds) to indicate that the power is on.

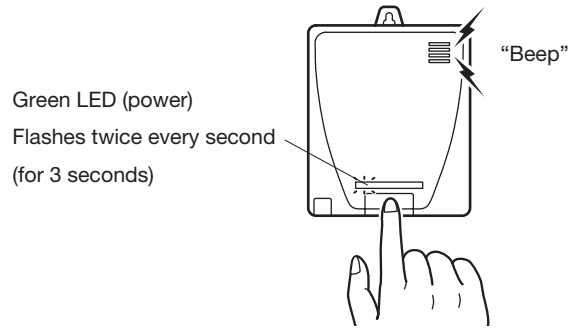

Green LED (power)
Flashes twice every second
(for 3 seconds)

Alarm push button function

If the switch is pressed for approximately 3 seconds, both a “Beep” and a “Beep Beep” will sound. If the switch is then released in less than 10 seconds, the red LED will flash once every 2 seconds and the gas alarm “Beep Beep Beep Danger – gas leak explosion risk – evacuate, then call 911.” will sound twice.

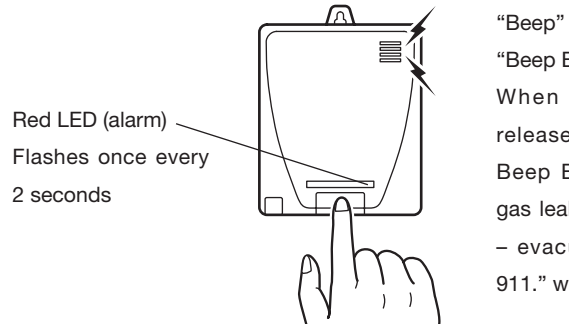

Red LED (alarm)
Flashes once every
2 seconds

“Beep”
“Beep Beep”
When the switch is released “Beep Beep Beep Beep Danger – gas leak explosion risk – evacuate, then call 911.” will sound twice.

Communication test function

If the switch is pressed for approximately 10 seconds, a “Beep”, “Beep Beep”, and “Beep Beep Beep” will sound. If the switch is then released, the green LED will flash 3 times every second and the gas detector will enter communication test mode.

* Communication test mode will automatically end after 5 minutes.

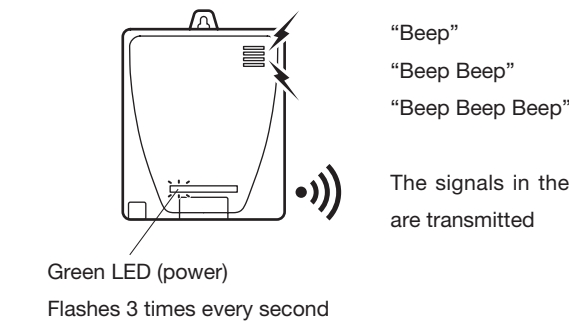

Green LED (power)
Flashes 3 times every second

“Beep”
“Beep Beep”
“Beep Beep Beep”
The signals in the following table are transmitted

The following communication tests will be performed each time the switch is pressed.

Status	Green LED	Yellow LED	Red LED	Alarm sound	Signal transmitted
After switch pressed for 10 seconds and released	Flashes 3 times every second	Off	Off	None	None
1st press of switch	Flashes twice every second	Off	Off	None	TX Normal
2nd press of switch	Flashes twice every second	Off	Flashes once every 2 seconds	None	TX Gas Alarm
3rd press of switch	Flashes twice every second	Flashes 3 times every second	Off	None	TX Trouble

Status	Green LED	Yellow LED	Red LED	Alarm sound	Signal transmitted
4th press of switch	Flashes twice every second	Flashes twice every second	Off	None	TX Low Battery
5th press of switch (Same as 1st press. Cycles back to top of functions.)	Flashes twice every second	Off	Off	None	TX Normal

What to do when the alarm “Beep Beep Beep Beep Danger – gas leak explosion risk – evacuate, then call 911.” sounds

 DANGER	Make sure that the following are observed when a gas alarm sounds. There may be a risk of explosion.
----------------	--

Leave the building immediately, opening doors and windows as you leave. Take others with you. If you are outside when you smell the gas, leave the area immediately.

Avoid causing a spark, which might cause the gas to explode:

1. Do not remove the connector from the lithium battery
2. Do not light a match or smoke.
3. Do not turn appliances or lights on or off.
4. Do not use a flashlight.
5. Do not start a car.
6. Do not use a telephone.

Find a phone away from the area and immediately call 911 and/or your natural gas utility. You can report leaks anonymously. Always call to report the problem. Do not assume someone else will do it.

Do not re-enter the area until the source of the leak is found and corrected. Follow directions from utility employees or emergency responders who are on site.

How to Install

Natural gas detectors should be installed above the point where a gas leak may occur.

They should be located near the ceiling, typically 12-inches (0.3 meters) from the ceiling.

Air movement around the detector must not be impeded by items hanging from the ceiling or near the ceiling such as curtains, drapes, ceiling fans. The detector should not be installed in the peak of a cathedral ceiling.

If a pipe in the meter room meets these requirements, then install this gas detector on the pipe using a cable tie as described below.

If a pipe that meets these requirements is not available, please mount to wall using hardware.

- (1) Pass the cable tie through the hole in the gas detector.

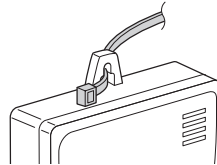

- (2) Wrap the cable tie around the pipe and tie off.

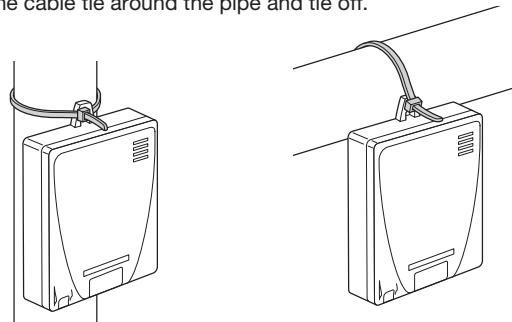

Where This Alarm Should Not Be Installed

Detectors should not be installed in:

- A. A small enclosed space;
- B. Directly above or near sources of water or humidity such as a sink, cooktop, dishwasher or bathroom;
- C. Directly above or near a gas appliance where incidental leaks during ignition may generate a false alarm, or where cooking vapors or grease may contaminate the detector;
- D. Next to a door or window;
- E. Next to a ventilation fan or cooktop hood;
- F. Near a room return or HVAC duct;
- G. In an area where the temperature will drop below 32°F (0°C) or exceed 122°F (50°C);
- H. In an area that is dusty or dirty;
- I. In an area where organic solvents exist;
- J. In a damp or very humid location.

Troubleshooting

Symptom	Cause	Action
The green LED does not flash even when the switch is pressed	Battery connector not plugged in	Plug in the battery connector.
	Battery is low	Replace the gas detector.
The yellow LED is flashing	Flashes 3 times every 10 seconds Gas detector trouble	Replace the gas detector.
	Flashes twice every 10 seconds End of gas detector service life	Replace the gas detector.
	Flashes once every 10 seconds Low gas detector battery	Replace the gas detector.

Disposal

When disposing of this product, do so in accordance with local laws and regulations.

Also, remove the lithium battery when disposing.

WARNING

- Wrap the removed lithium battery with tape, etc., so that the connector portion does not short. Such a short may cause heat generation, an explosion, or ignition to occur. Any of these may result in injury or fire.

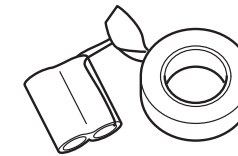

Wireless notes

- This device complies with Part 15 of the FCC Rules. Operation is subject to the following two conditions: (1) This device may not cause harmful interference. and (2) this device must accept any interference received, including interference that may cause undesired operation.
- Pursuant to FCC 15.21 of the FCC rules, changes not expressly approved by NEW COSMOS ELECTRIC CO.,LTD. might cause harmful interference and void the FCC authorization to operate this product.
- The antennas used for this transmitter must be installed to provide a separation distance of at least 20 cm from all persons and must not be co-located or operated in conjunction with any other antenna or transmitter.
- This product complies with FCC OET Bulletin 65 & Industry Canada's RSS-102 radiation exposure limits set forth for an uncontrolled environment.

Specifications

Conforming standards	UL standard (UL1484), FCC certified
Detection principle	MEMS hot wire semiconductor sensor
Target gas	Methane gas
Gas immunity*	Acetone, ethanol, bleach solution
Operating temperature range	32°F (0°C) to 122°F (50°C)
Operating humidity range	5% to 95%, no condensation
Power supply	CR17450E-R-2-CN DC3V, 300mA (dedicated connector connection)
Battery warranty	5 years
Alarm level	10%LEL
Response time	120 sec. (25%LEL)
Sound pressure	Gas alarm : 85 dB/10 feet
Initial power-up timer	Approx. 30 seconds (green LED flashes once every second)
Power indicator	A “Beep” will sound once when the switch is pressed for less than 3 seconds and the green LED will flash twice every second (for 3 seconds)
Gas alarm	Red LED flashes once every 2 seconds Gas alarm sounds “Beep Beep Beep Danger – gas leak explosion risk – evacuate, then call 911” every 6 seconds. Alarm will continue as described for 4 minutes. After 4 minutes, Alarm Sound will be produced 1X/60sec and LED will blink as described during sound. Visual and audible signals will not stop until the product is reset by removing and reinstalling the battery.
Trouble alarm	Yellow LED flashes 3 times every 10 seconds
Low battery	Yellow LED flashes once every 10 seconds
Alarm push button function	Product produces Gas alarm signal when the switch is pressed for more than 3 seconds.
Communication test function	Communication test is performed when the switch is pressed for more than 10 seconds
End of service life	Yellow LED flashes twice every 10 seconds
Battery removal indicator	The battery removal indicator will consist of a transparent battery cover that when a battery is not present exposes a warning flag label with the following markings: WARNING : NO BATTERY! Alarm is non-operational.
Weight and dimensions	Approx. 140 g, W 85 × H 100 × D 22 mm (excluding protrusions)
Installation	Pipe mount by cable ties or wall mount with hardware.
Accessories	User’s Manual (this manual)

* Validated by Gas Technology Institute report, Evaluation of Residential Methane Detectors, Phase III. Project No. 21696. Report Issued July 25, 2017 https://www.newcosmos-global.com/product/gti_report.pdf

Warranty and Replacement

Warranty and Replacement are as stipulated in the STANDARD TEAMS AND CONDITIONS

Contact Details

Consolidated Edison Company of New York, Inc.

4 Irving Place, New York, NY 10003

1-212-460-4600

conEd.com