

FCC Part 22H & 24E Measurement and Test Report

For

LOWEX, LLC

FCC ID: 2AREV-LWXF24

FCC Rules:	<u>FCC Part 22H, FCC Part 24E</u>
Product Description:	<u>feature phone</u>
Tested Model:	<u>F24</u>
Report No.:	<u>BSL008390304RF</u>
Tested Date:	<u>November 16-18, 2018</u>
Issued Date:	<u>November 24, 2018</u>
Tested By:	<u>Messi Wang / Engineer</u> <i>Messi Wang</i>
Reviewed By:	<u>Lisa. Li / EMC Manager</u> <i>Lisa. Li</i>
Approved & Authorized By:	<u>Mike mo / PSQ Manager</u> <i>Mike mo</i>
Prepared By:	

BSL Testing Co.,LTD.
NO. 24, ZH Park, Nantou, Shenzhen, 518000 China
Tel: 400-882-9628 Fax: 86- 755-26508703

TABLE OF CONTENTS

1. GENERAL INFORMATION.....	3
1.1 PRODUCT DESCRIPTION FOR EQUIPMENT UNDER TEST (EUT).....	3
1.2 EUT SETUP AND TEST MODE.....	5
1.3 TEST STANDARDS.....	5
1.4 TEST METHODOLOGY.....	5
1.5 TEST FACILITY.....	5
1.6 MEASUREMENT UNCERTAINTY.....	6
1.7 EQUIPMENT LIST AND DETAILS.....	6
2. SUMMARY OF TEST RESULTS.....	7
3. RF EXPOSURE.....	8
3.1 STANDARD APPLICABLE.....	8
3.2 TEST RESULT.....	8
4. CONDUCTED AV OUTPUT POWER.....	9
5. PEAK-TO-AVERAGE RATIO.....	11
6. OCCUPY BANDWIDTH.....	13
7. MODULATION CHARACTERISTIC.....	27
8. OUT OF BAND EMISSION AT ANTENNA TERMINALS.....	27
9. ERP, EIRP MEASUREMENT.....	35
10. FIELD STRENGTH OF SPURIOUS RADIATION MEASUREMENT.....	41
11. FREQUENCY STABILITY V.S. TEMPERATURE MEASUREMENT.....	45
12. FREQUENCY STABILITY V.S. VOLTAGE MEASUREMENT.....	48

1. GENERAL INFORMATION

1.1 Product Description for Equipment Under Test (EUT)

Applicant:	LOWEX, LLC
Address of applicant:	739 NW 105th Pl, Miami, Florida 33172, USA
Manufacturer:	LuZhou XinYu Communication Technology Co., LTD
Address of manufacturer:	NO.19, Section 5, JiuGu Avenue, High Tech District, LuZhou City, SiChuan Provice, China
Product Name:	feature phone
Model No.:	F24
Test Model No:	F24
Remark: All above models are identical in the same PCB layout, interior structure and electrical circuits. The differences are color and model name for commercial purpose.	
Sample(s) Status:	Engineer sample
Quantity of tested samples	1
Serial No.:	N/A
Description test modes:	SIM 1 and SIM 2 is a chipset unit,the wors case is SIM1.
Hardware Version:	DF600_PCB
Software Version:	DF600_DF600E_HC
Support Networks:	GSM, GPRS
Support Bands:	GSM850, PCS1900,
TX Frequency:	GSM850: 824.20MHz-848.80MHz PCS1900: 1850.20MHz-1909.80MHz
GPRS Class:	12
Modulation type:	GSM/GPRS: GMSK
Antenna type:	Internal antenna
Antenna gain:	0.6dBi(max.) For GSM 850 0.7dBi(max.) For DCS 1900
Power supply:	DC 3.7V by battery or DC 5V from adapter input AC 120V, 60Hz

Operation Frequency List:

GSM 850		PCS1900	
Channel	Frequency (MHz)	Channel	Frequency (MHz)
128	824.20	512	1850.20
129	824.40	513	1850.40
· ∴	· ∴	· ∴	· ∴
189	836.40	660	1879.80
190	836.60	661	1880.00
191	836.80	662	1880.20
· ∴	· ∴	· ∴	· ∴
250	848.60	809	1909.60
251	848.80	810	1909.80

Regards to the operating frequency range over 10 MHz, the Lowest frequency, the middle frequency, and the highest frequency of channel were selected to perform the test, and the selected channel see below:

Final test channel:

GSM 850		PCS1900	
Channel	Frequency (MHz)	Channel	Frequency (MHz)
128	824.20	512	1850.20
190	836.60	661	1880.00
251	848.80	810	1909.80

EUT Cable List and Details

Cable Description	Length (M)	Shielded/Unshielded	With Core/Without Core
Earphone	1.0	Unshielded	Without Ferrite

Auxiliary Equipment List and Details

Description	Manufacturer	Model	Serial Number
Adapter	JINFULIN	A01	/

Special Cable List and Details

Cable Description	Length (M)	Shielded/Unshielded	With Core/Without Core
/	/	/	/

1.2 EUT Setup and Test Mode

During all testing, EUT is in link mode with base station emulator at maximum power level. The spurious emission measurements were carried out in semi-anechoic chamber with 3-meter test range, and EUT is rotated on three test planes to find out the worst emission.

Test modes		
Band	Radiated	Conducted
GSM 850	■ GSM link	■ GSM link
	■ GPRS 1 link	■ GPRS 1 link
PCS 1900	■ GSM link	■ GSM link
	■ GPRS 1 link	■ GPRS 1 link

Note: The maximum power levels are GSM mode for GMSK link, GPRS multi-slot class 8 mode for GMSK link. only these modes were used for all tests.

1.3 Test Standards

The following report accordance with FCC Part 2 subpart J, FCC Part 22 subpart H and FCC Part 24 subpart E of the Federal Communication Commission rules.

1.4 Test Methodology

Both conducted and radiated testing were performed according to the procedures document on ANSI/TIA-603-E (2016) and FCC CFR 47.1046, 2.1047, 2.1049, 2.1051, 2.1053, 2.1055 and 2.1057, ANSI C63.26-2015.

1.5 Test Facility

BSL Testing Co.,LTD.

NO. 24, ZH Park, Nantou, Shenzhen, 518000 China

Test Firm Registration Number: 866035

Designation Number: CN1217

Tel: Tel: 400-882-9628

Fax: 86- 755-26508703

1.6 Measurement Uncertainty

Measurement uncertainty		
Parameter	Conditions	Uncertainty
RF Output Power	Conducted	$\pm 0.42\text{dB}$
Occupied Bandwidth	Conducted	$\pm 1.5\%$
Frequency Stability	Conducted	2.3%
Transmitter Spurious Emissions	Radiated	$\pm 5.1\text{dB}$
Transmitter Spurious Emissions	Conducted	$\pm 0.42\text{dB}$

1.7 Equipment List and Details

Description	Manufacturer	Model	Serial No.	Cal Date	Due. Date
Communication Tester	Rohde & Schwarz	CMW500	100358	2018-11-08	2019-11-07
Spectrum Analyzer	R&S	FSP40	100550	2018-10-08	2019-10-07
Test Receiver	R&S	ESCI7	US47140102	2018-10-08	2019-10-07
Signal Generator	HP	83630B	3844A01028	2018-10-08	2019-10-07
Test Receiver	R&S	ESPI-3	100180	2018-10-08	2019-10-07
Amplifier	Agilent	8449B	4035A00116	2018-10-08	2019-10-07
Amplifier	HP	8447E	2945A02770	2018-10-08	2019-10-07
Signal Generator	IFR	2023A	202307/242	2018-10-08	2019-10-07
Broadband Antenna	SCHAFFNER	2774	2774	2018-10-21	2019-10-20
Biconical and log periodic antennas	ELECTRO-METRICS	EM-6917B-1	171	2018-10-21	2019-10-20
Horn Antenna	R&S	HF906	100253	2018-10-21	2019-10-20
Horn Antenna	EM	EM-6961	6462	2018-10-21	2019-10-20
LISN	R&S	ESH3-Z5	100196	2018-10-08	2019-10-07
LISN	COM-POWER	LI-115	02027	2018-10-08	2019-10-07
3m Semi-Anechoic Chamber	Chengyu Electron	9 (L)*6 (W)* 6 (H)	BSL086	2018-10-08	2019-10-07
Horn Antenna	Schwarzbeck	BBHA9170	00814	2018-10-21	2019-10-20

2. SUMMARY OF TEST RESULTS

Test Item	Section in CFR 47	Result
RF Exposure (SAR)	Part 1.1307 Part 2.1093	Pass* (Please refer to SAR Report)
RF Output Power	Part 2.1046 Part 22.913 (a)(2) Part 24.232 (c)	Pass
Peak-to-Average Ratio	Part 2.1046 Part 24.232 (d)	Pass
Modulation Characteristics	Part 2.1047	Pass
99% & -26 dB Occupied Bandwidth	Part 2.1049 Part 22.917 Part 24.238	Pass
Spurious Emissions at Antenna Terminal	Part 2.1051 Part 22.917 (a) Part 24.238 (a)	Pass
Field Strength of Spurious Radiation	Part 2.1053 Part 22.917 (a) Part 24.238 (a)	Pass
Out of band emission, Band Edge	Part 22.917 (a) Part 24.238 (a)	Pass
Frequency stability vs. temperature	Part 2.1055(a)(1)(b)	Pass
Frequency stability vs. voltage	Part 2.1055(d)(1)(2)	Pass

3. RF EXPOSURE

3.1 Standard Applicable

According to § 1.1307 and § 2.1093, the portable transmitter must comply the RF exposure requirements.

3.2 Test Result

This product complied with the requirement of the RF exposure, please see the SAR report.

4. CONDUCTED AV OUTPUT POWER

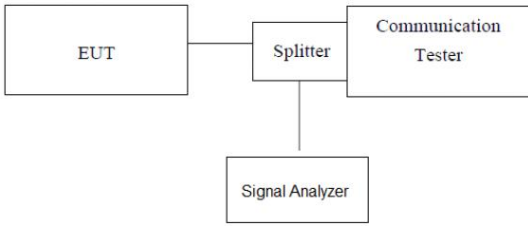
Test Requirement:	FCC part22.913(a) and FCC part24.232(b)
Test Method:	FCC part2.1046
Limit:	GSM850, WCDMA Band V: 7W PCS1900, WCDMA Band II: 2W
Test setup:	 <p><i>Note: Measurement setup for testing on Antenna connector</i></p>
Test Procedure:	<ol style="list-style-type: none"> 1. The transmitter output port was connected to base station. 2. The RF output of EUT was connected to the Signal Analyzer by RF cable and attenuator, the path loss was compensated to the results for each measurement. 3. Set EUT at maximum power through base station. 4. Select lowest, middle, and highest channels for each band and different modulation. 5. Measure the maximum burst average power.
Test Instruments:	Refer to section 1.7 for details
Test mode:	Refer to section 1.2 for details
Test results:	Pass

Measurement Data

GSM 850	Tune-up	Burst Conducted power (dBm)			Division Factors	Tune-up	Average power (dBm)			
		Channel/Frequency(MHz)					Channel/Frequency(MHz)			
	Max	128/824.2	190/836.6	251/848.8		Max	128/824.2	190/836.6	251/848.8	
GSM	33.00	32.15	32.06	32.01	-9.03dB	23.97	23.12	23.03	22.98	
GPRS (GMSK)	1TX slot	32.00	31.86	31.83	31.67	-9.03dB	22.97	22.83	22.80	22.64
	2TX slot	31.00	30.89	30.66	30.79	-6.02dB	24.98	24.87	24.64	24.77
	3TX slot	29.00	28.73	28.86	28.65	-4.26dB	24.74	24.47	24.60	24.39
	4TX slot	27.00	26.90	26.89	26.57	-3.01dB	23.99	23.89	23.88	23.56
GSM 1900	Tune-up	Burst Conducted power (dBm)			Division Factors	Tune-up	Average power (dBm)			
		Channel/Frequency(MHz)					Channel/Frequency(MHz)			
	Max	512/1850.2	661/1880	810/1909.8		Max	512/1850.2	661/1880	810/1909.8	
GSM	30.00	29.23	29.15	29.05	-9.03dB	20.97	20.20	20.12	20.02	
GPRS (GMSK)	1TX slot	29.00	28.74	28.54	28.89	-9.03dB	19.97	19.71	19.51	19.86
	2TX slot	27.00	26.93	26.87	26.75	-6.02dB	20.98	20.91	20.85	20.73
	3TX slot	26.00	25.92	25.77	25.88	-4.26dB	21.74	21.66	21.51	21.62
	4TX slot	25.00	24.79	24.91	24.99	-3.01dB	21.99	21.78	21.90	21.98

Notes:

1. Division Factors

To average the power, the division factor is as follows:

1TX-slot = 1 transmit time slot out of 8 time slots=> conducted power divided by (8/1) => -9.00dB

2TX-slots = 2 transmit time slots out of 8 time slots=> conducted power divided by (8/2) => -6.00dB

3TX-slots = 3 transmit time slots out of 8 time slots=> conducted power divided by (8/3) => -4.26dB

4TX-slots = 4 transmit time slots out of 8 time slots=> conducted power divided by (8/4) => -3.00dB

2. According to the conducted power as above, the GPRS measurements are performed with 2Txslot for GPRS850 and 4Txslot GPRS1900.

3. This EUT owns two SIM cards , we found the SIM 1 is the worst case ,so its result is recorded in this report.

5. PEAK-TO-AVERAGE RATIO

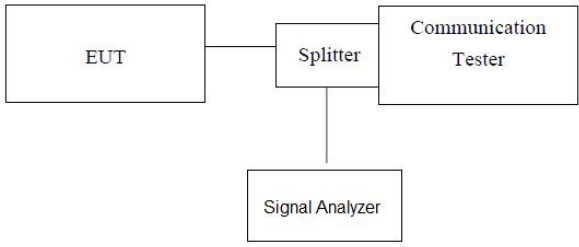
Test Requirement:	FCC part24.232(d)
Test Method:	FCC part2.1046
Limit:	13db
Test setup:	 <p><i>Note: Measurement setup for testing on Antenna connector</i></p>
Test Procedure:	<ol style="list-style-type: none"> 1. The transmitter output port was connected to base station. 2. The RF output of EUT was connected to the Signal Analyzer by RF cable and attenuator, the path loss was compensated to the results for each measurement. 3. Set EUT at maximum power through base station. 4. Select lowest, middle, and highest channels for each band and different modulation. 5. Measure the maximum burst average power. 6. Set the CCDF (Complementary Cumulative Distribution Function) option of the spectrum analyzer. Record the maximum PAPR level associated with a probability of 0.1%.
Test Instruments:	Refer to section 1.7 for details
Test mode:	Refer to section 1.2 for details
Test results:	Pass

Measurement data

Only show the wors case

Test mode	Peak to Average Ratio (dB)			Limit (dB)	Result
	Low Ch.	Middle Ch.	High Ch.		
GSM1900	0.25	0.28	0.27	13	PASS
GPRS1900	0.24	0.26	0.22	13	PASS

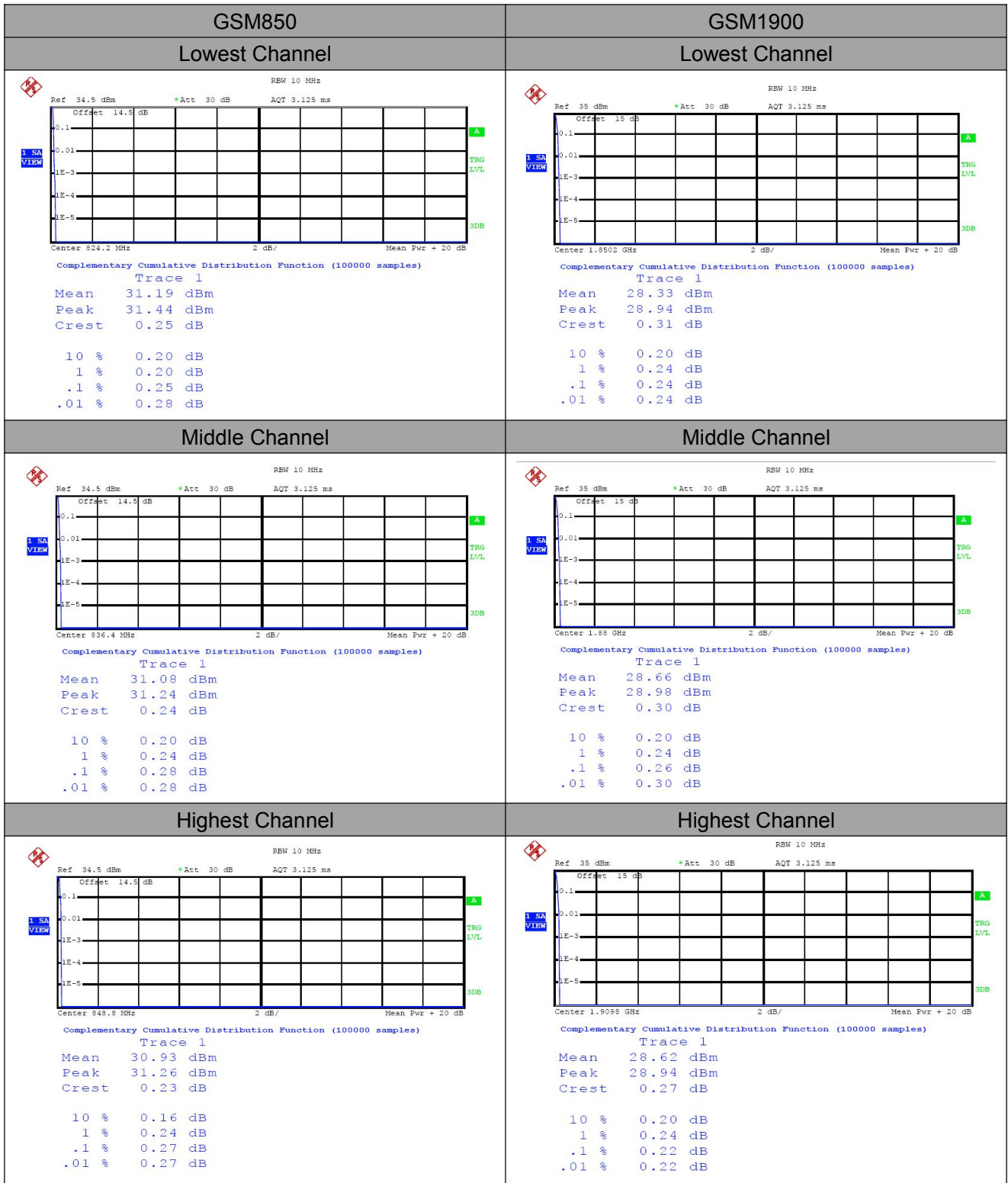

6. OCCUPY BANDWIDTH

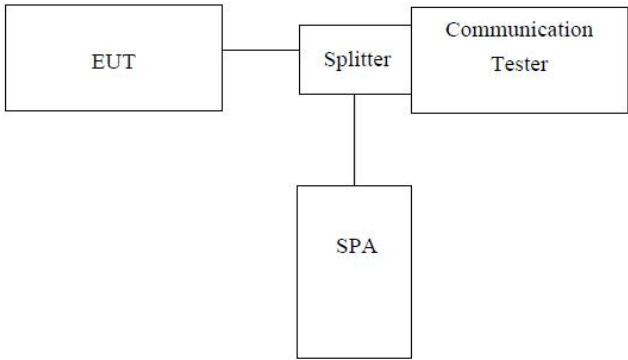
Test Requirement:	FCC part22.913(a) and FCC part24.232(b)
Test Method:	FCC part2.1049
Test setup:	 <pre> graph LR EUT[EUT] --- Splitter[Splitter] Splitter --- CT[Communication Tester] Splitter --- SPA[SPA] </pre> <p><i>Note: Measurement setup for testing on Antenna connector</i></p>
Test Procedure:	<ol style="list-style-type: none"> 1. The EUT's output RF connector was connected with a short cable to the spectrum analyzer 2. RBW was set to about 1% of emission BW, VBW= 3 times RBW. 3. -26dBc display line was placed on the screen (or 99% bandwidth), the occupied bandwidth is the delta frequency between the two points where the display line intersects the signal trace.
Test Instruments:	Refer to section 1.7 for details
Test mode:	Refer to section 1.2 for details
Test results:	Pass

Measurement Data

EUT Mode	Channel	Frequency (MHz)	99% Occupy bandwidth (KHz)	-26dB bandwidth (KHz)
GSM 850 (GSM link)	128	824.2	250	334.00
	190	836.6	250	334.00
	251	848.8	250	334.00
GSM 850 (GPRS 1 link)	128	824.2	248	336.00
	190	836.6	248	338.00
	251	848.8	246	332.00
PCS 1900 (GSM link)	512	1850.2	248	340.00
	661	1880.0	252	336.00
	810	1909.8	250	336.00
PCS 1900 (GPRS 1 link)	512	1850.2	250	334.00
	661	1880.0	248	332.00
	810	1909.8	250	332.00

Test plot as follows:

Only the worst case was selected to record

Occupied Bandwidth for GSM Mode GSM850

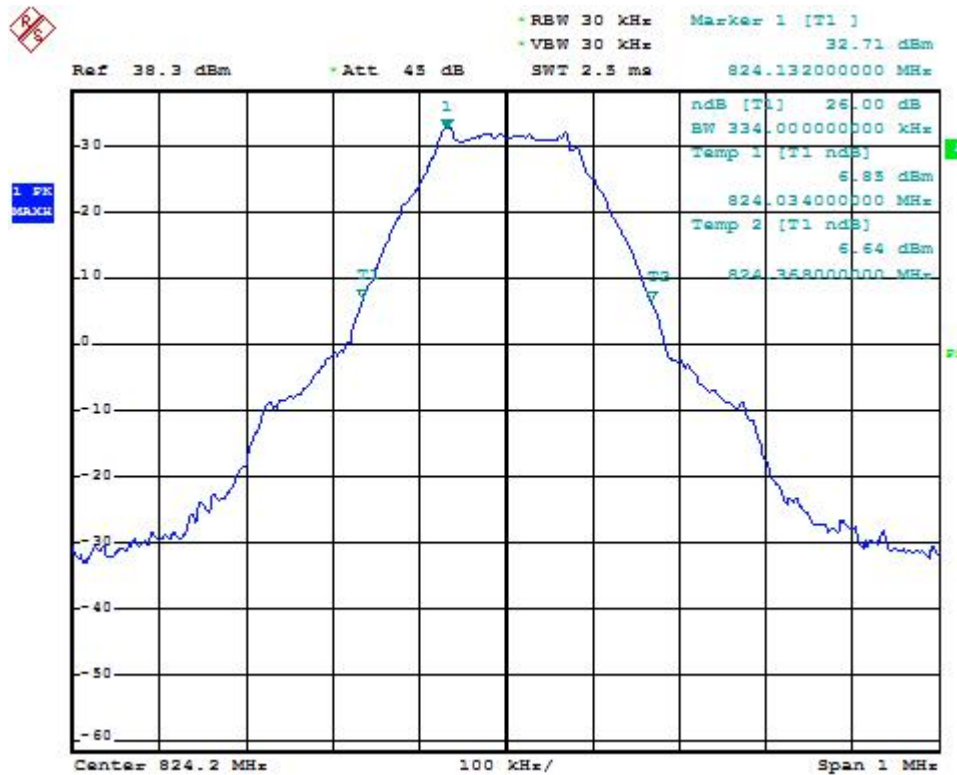
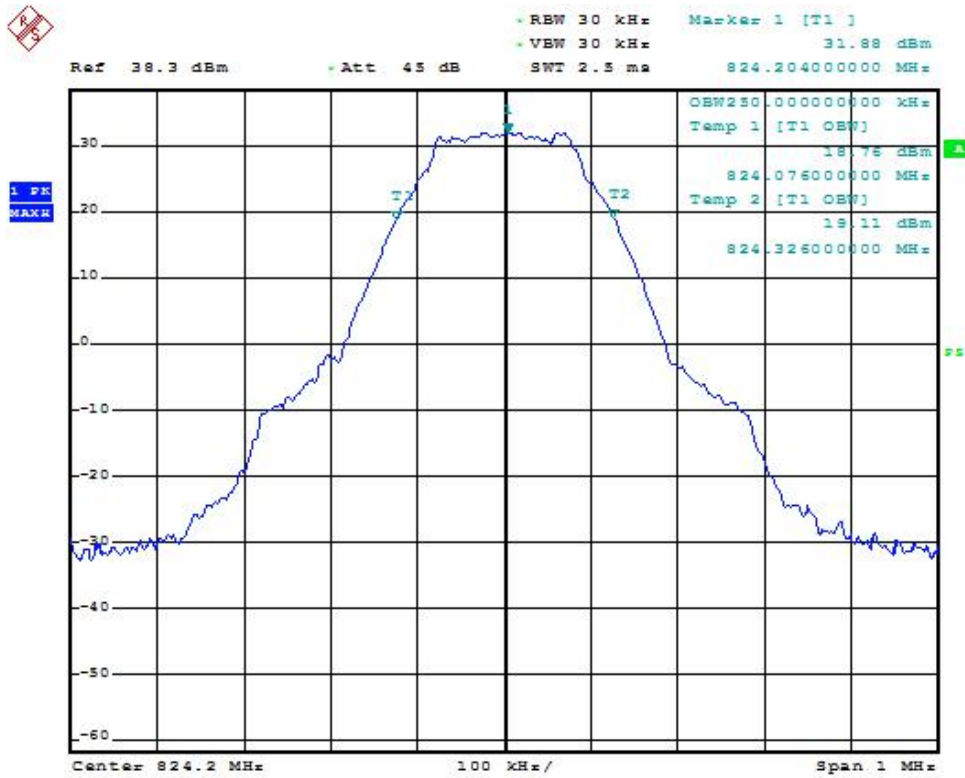

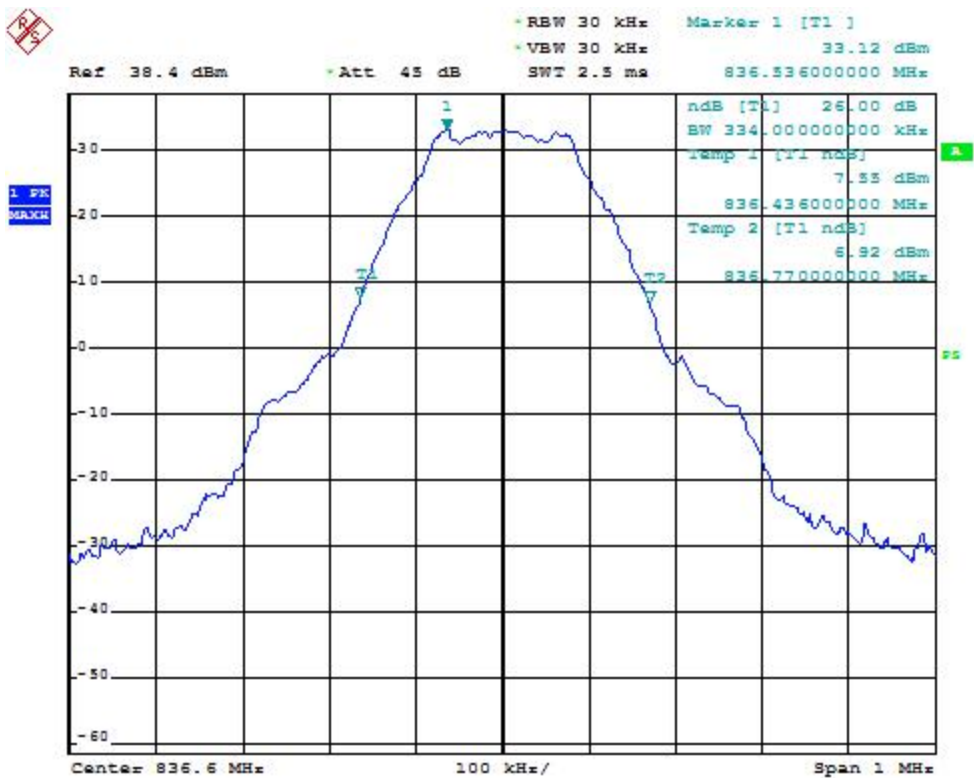
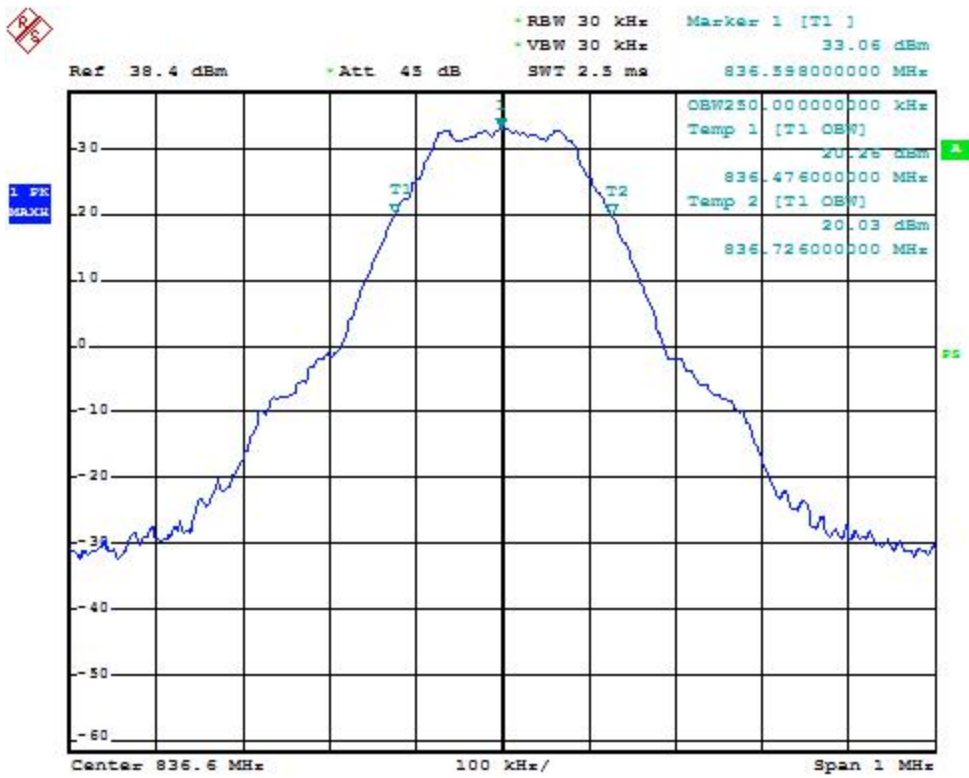

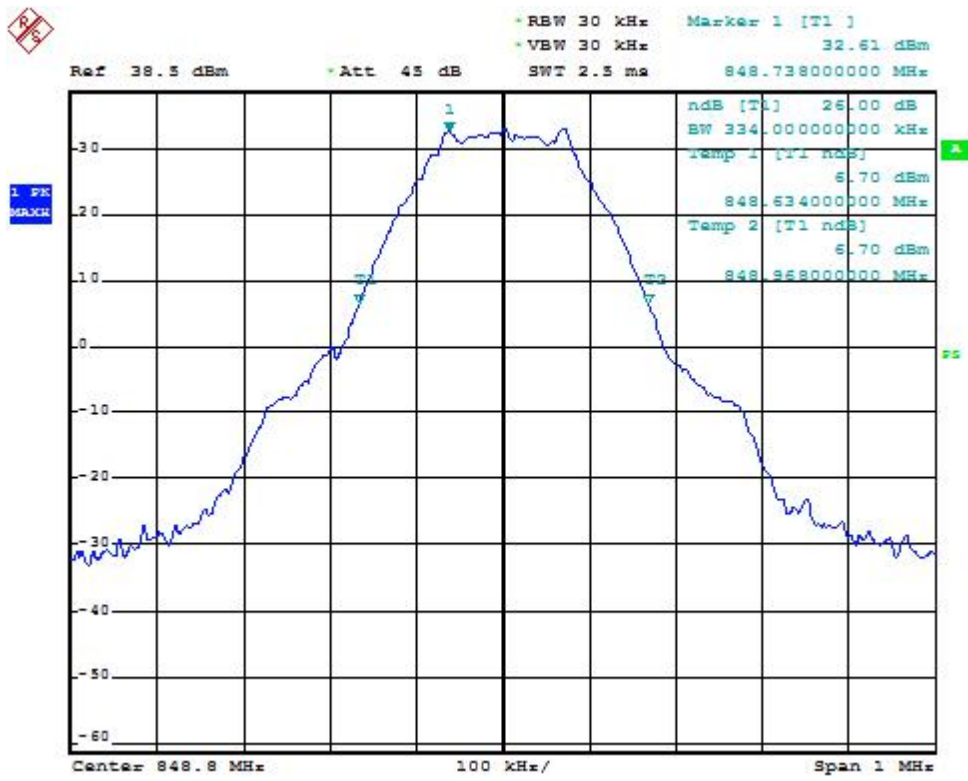
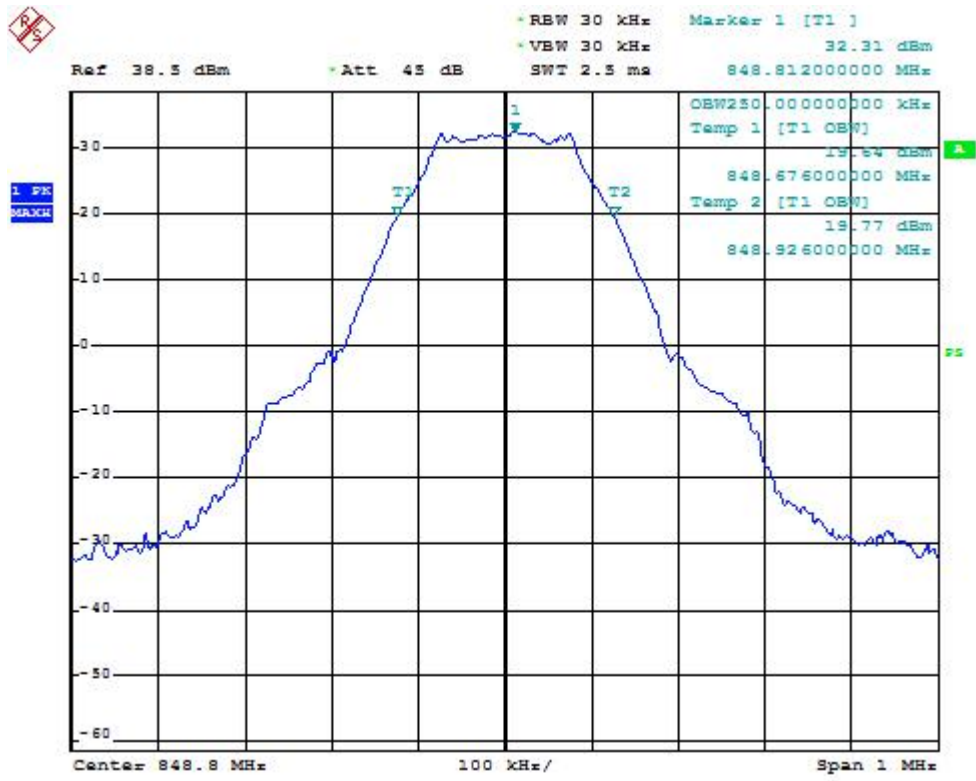

Occupied Bandwidth for GSM Mode PCS1900

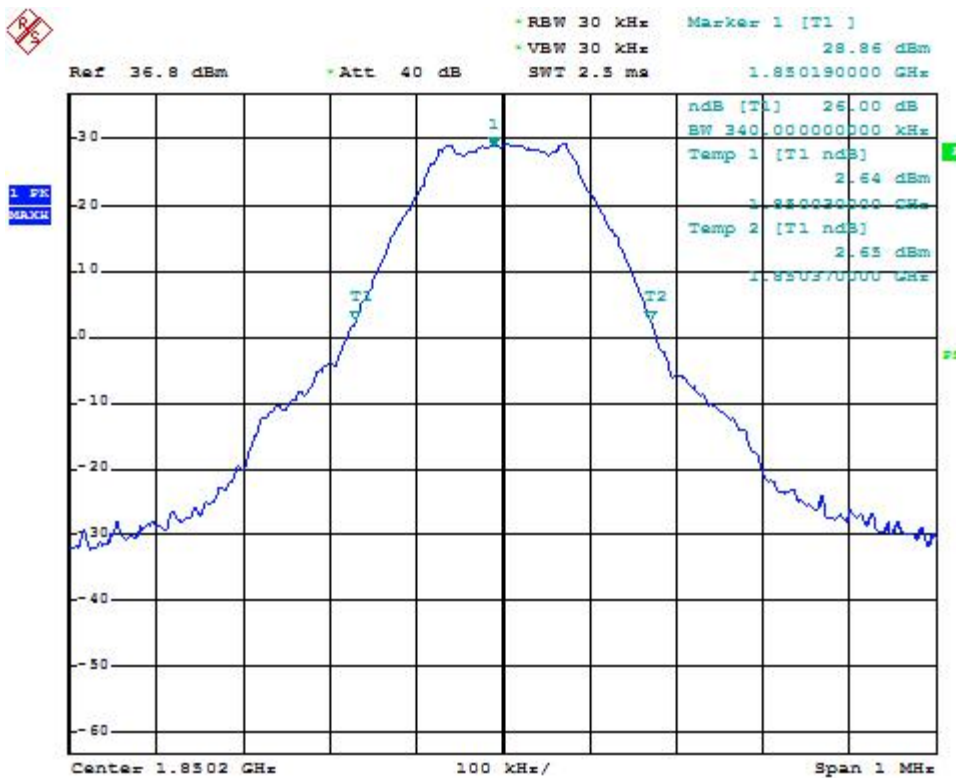
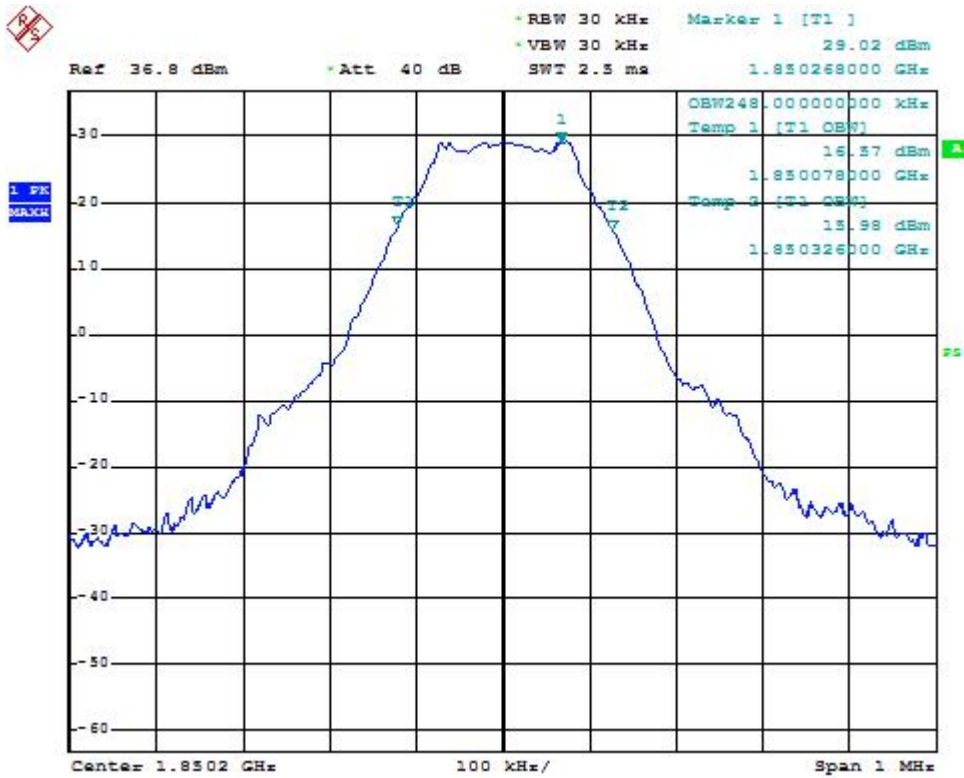

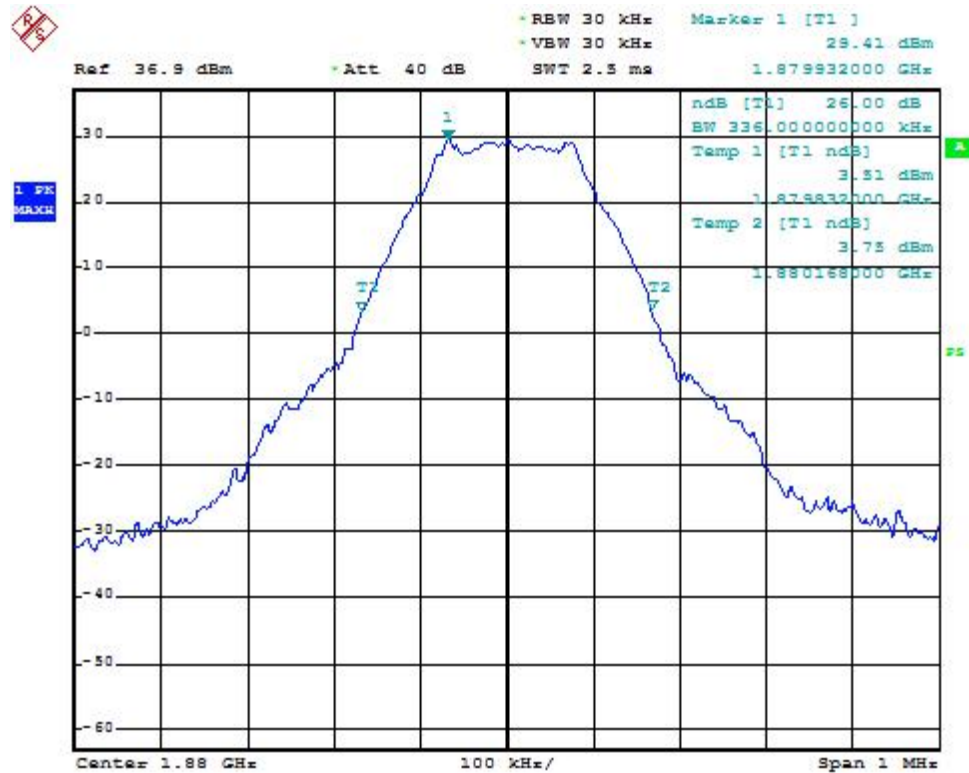
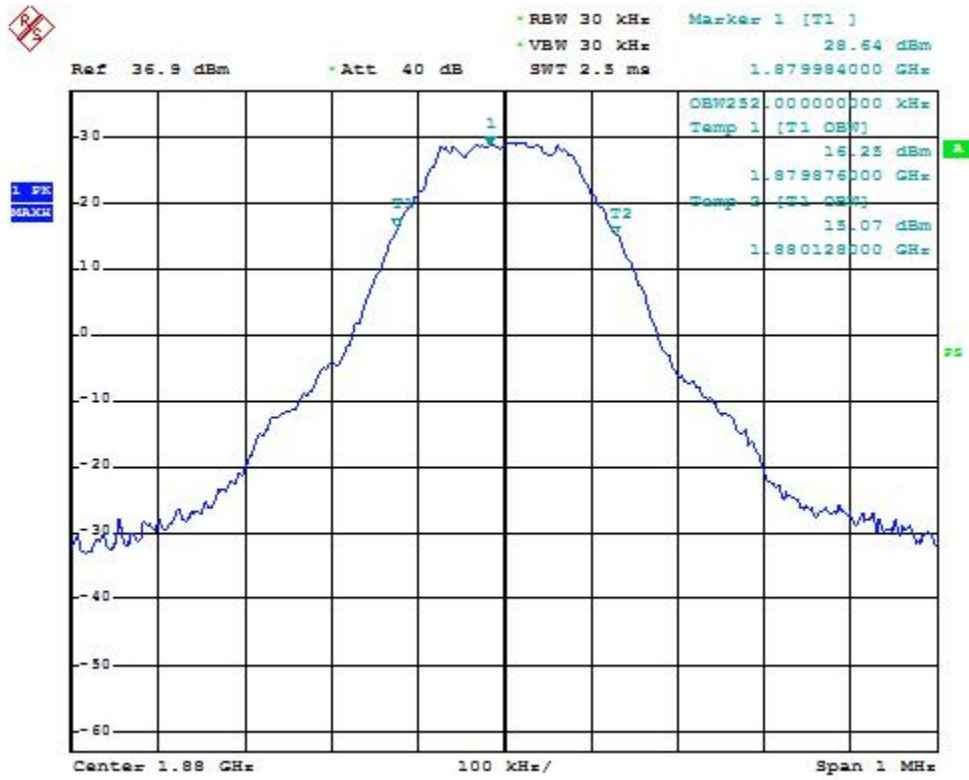

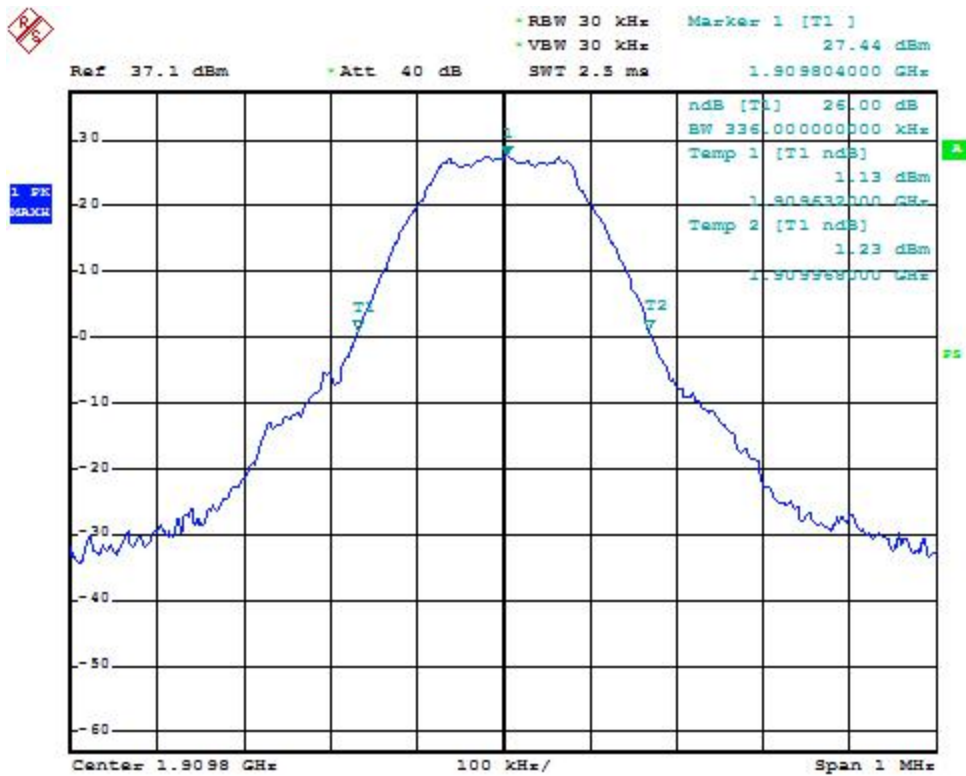
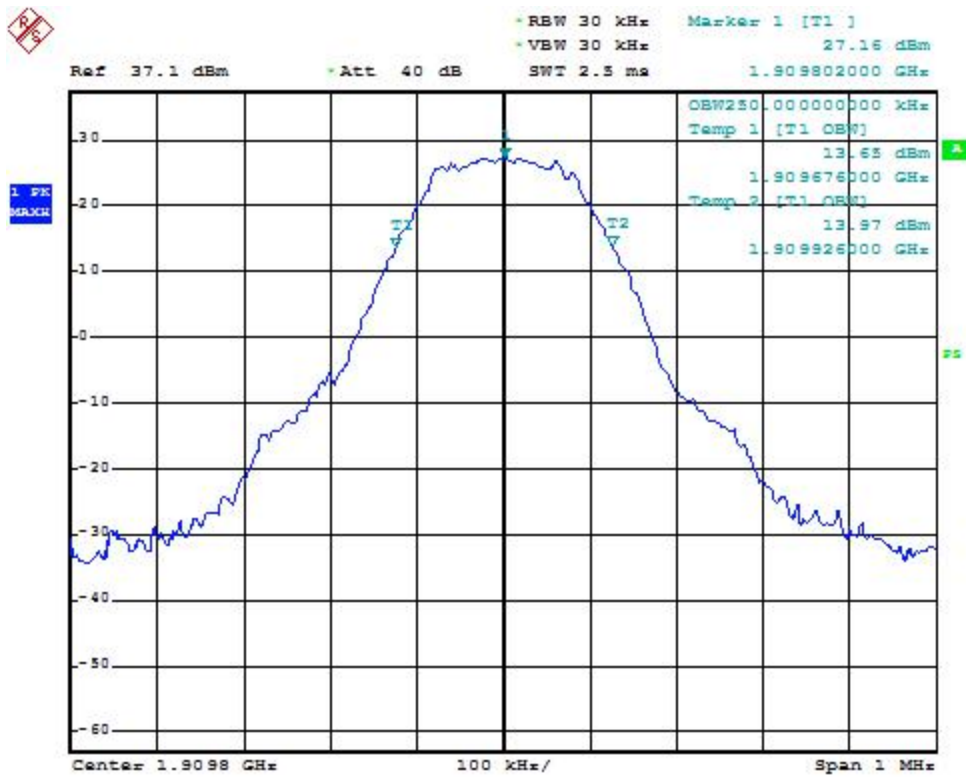

Occupied Bandwidth For GPRS Mode GSM 850

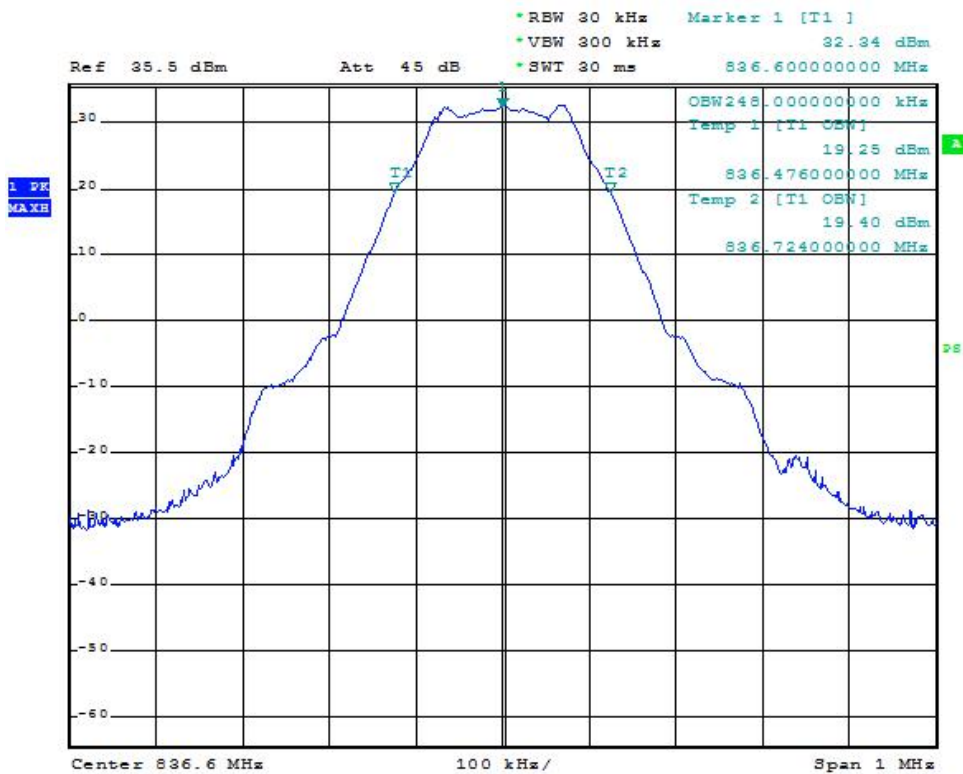
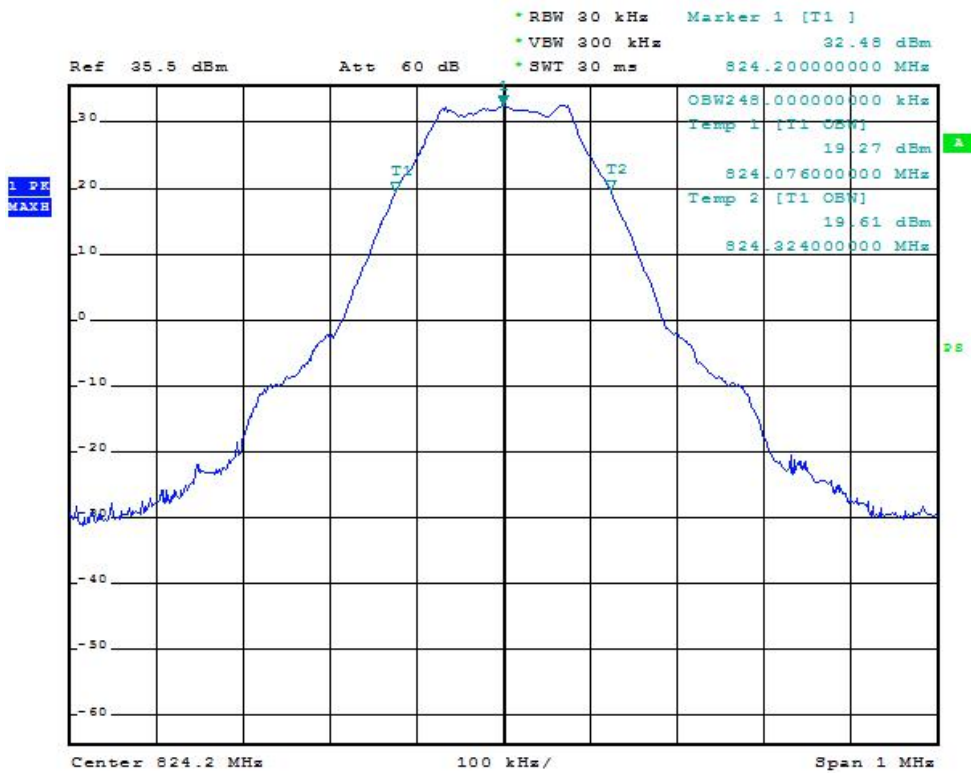

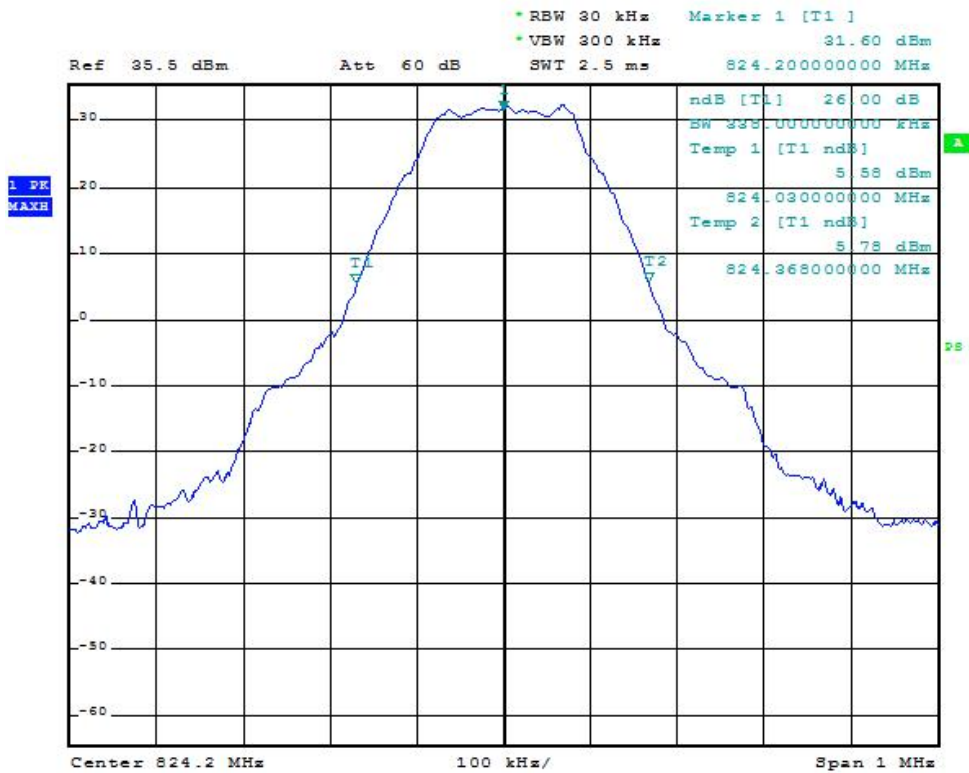
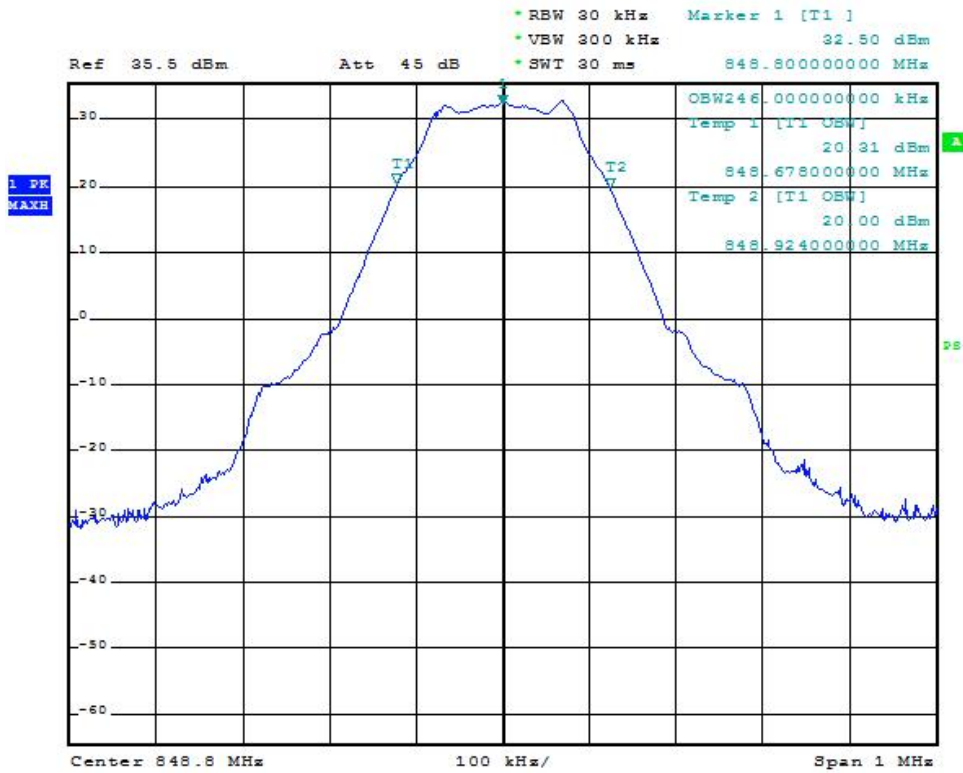

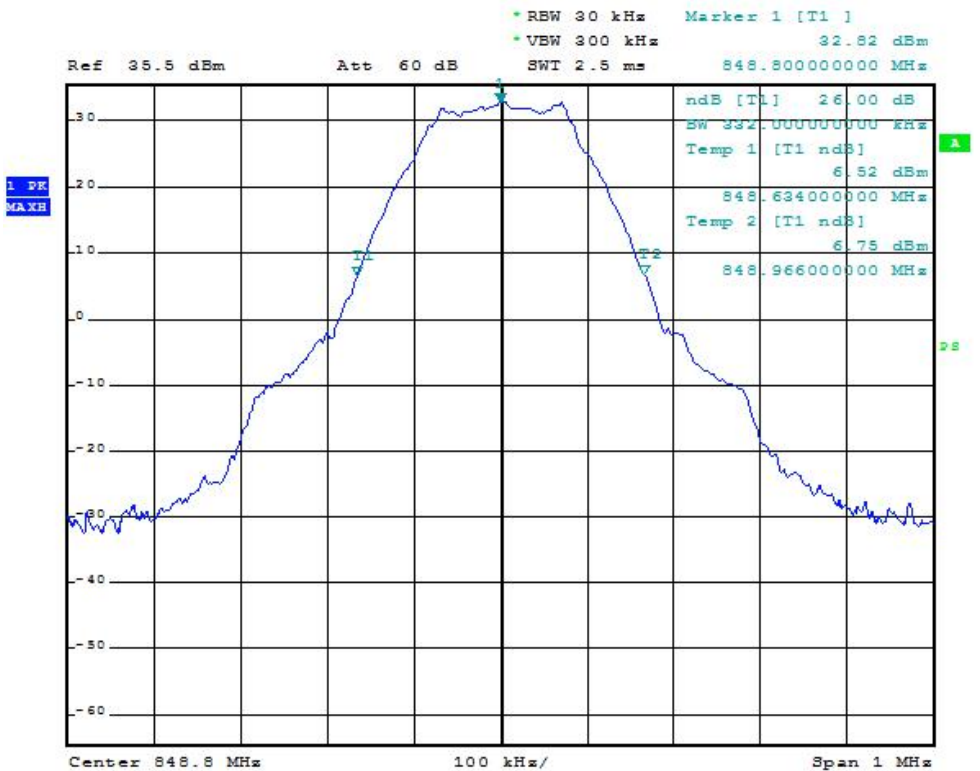
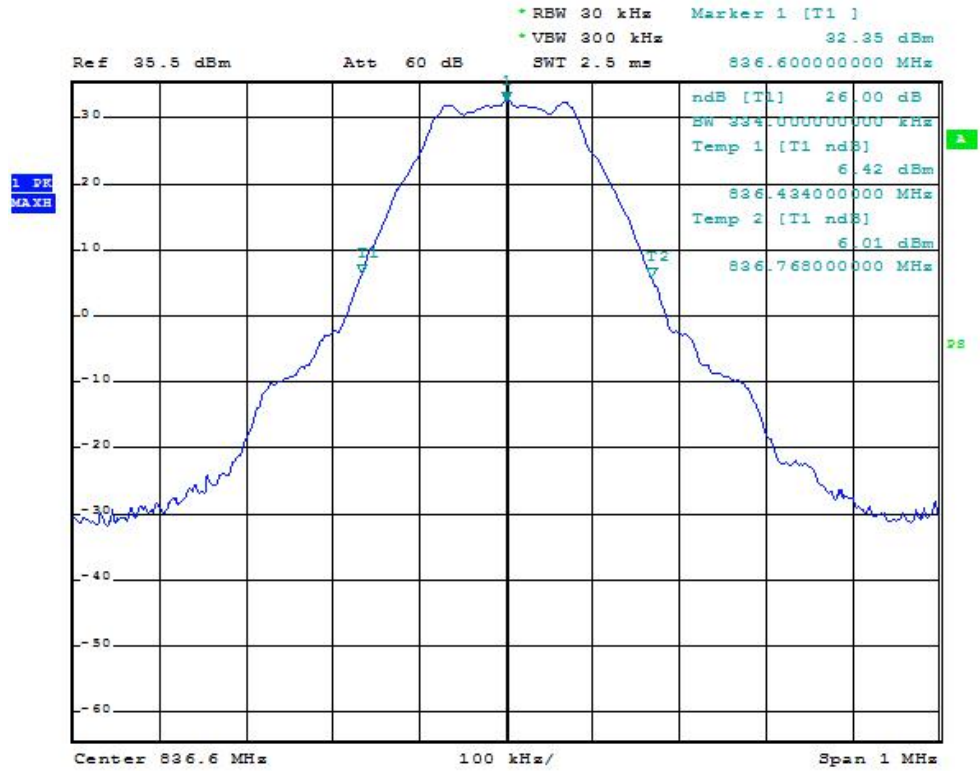

Occupied Bandwidth For GPRS Mode PCS1900

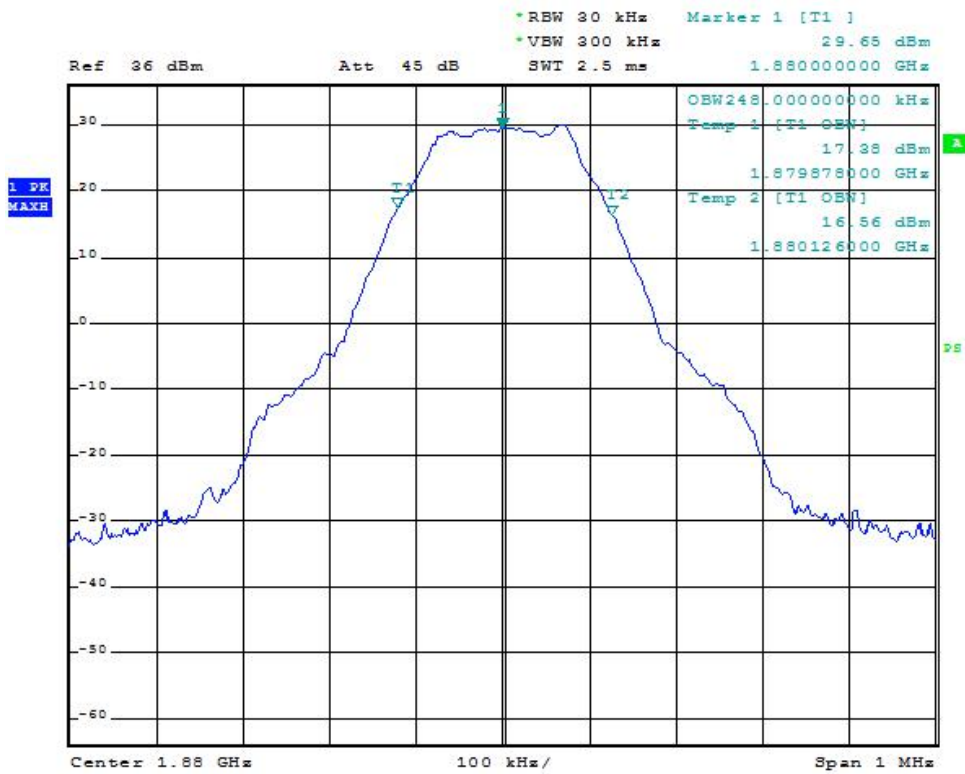
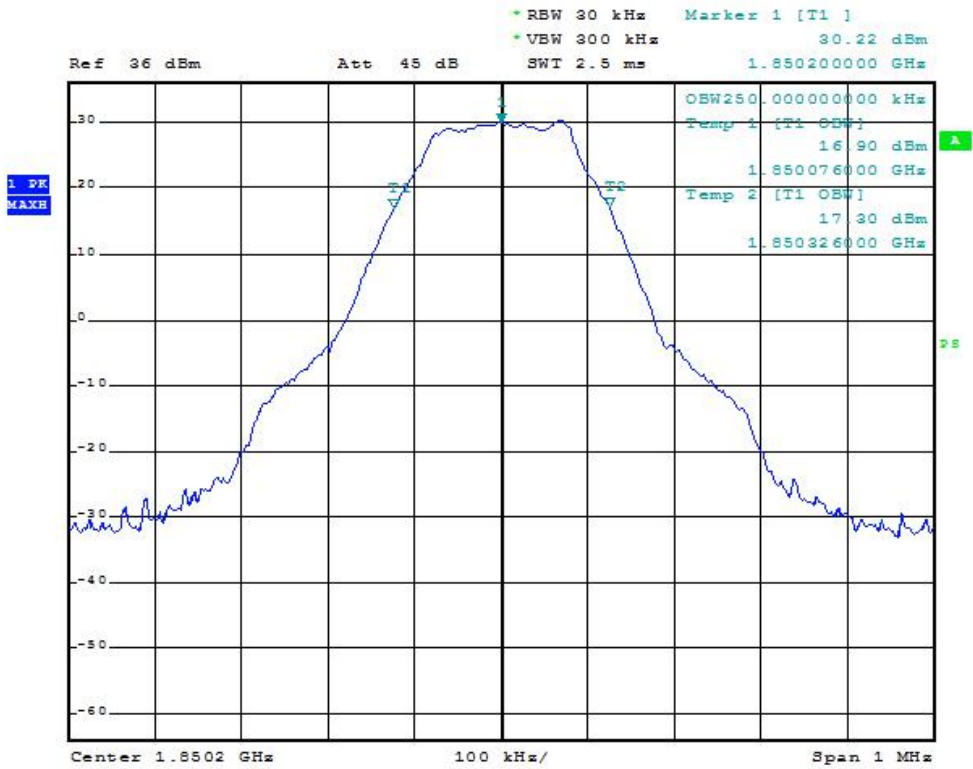

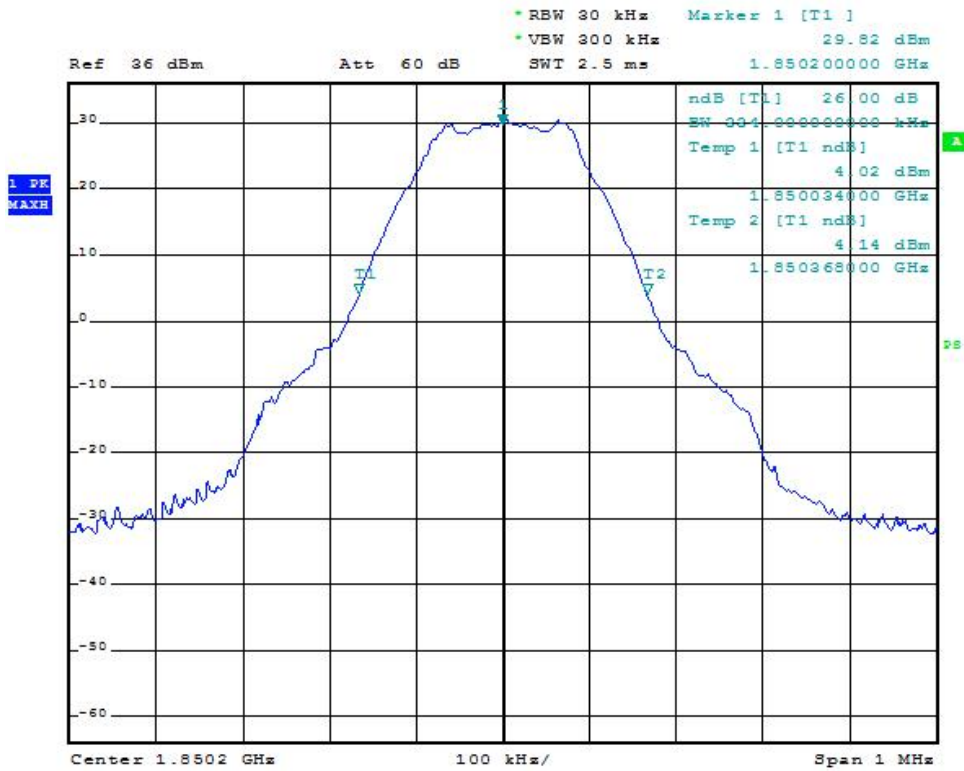
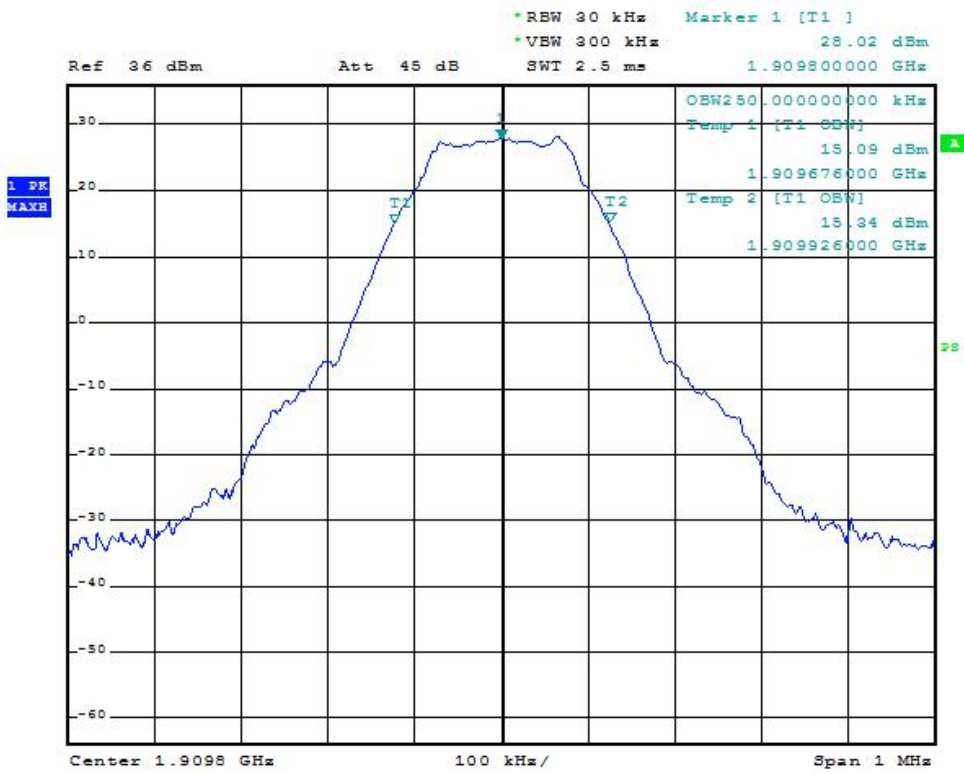

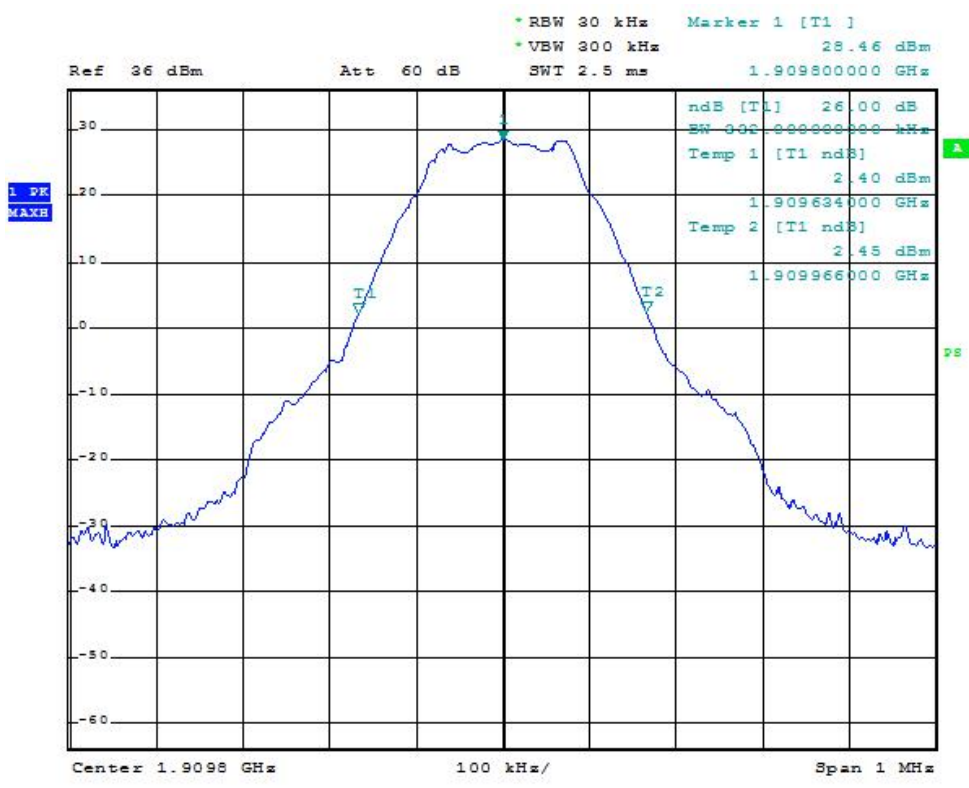
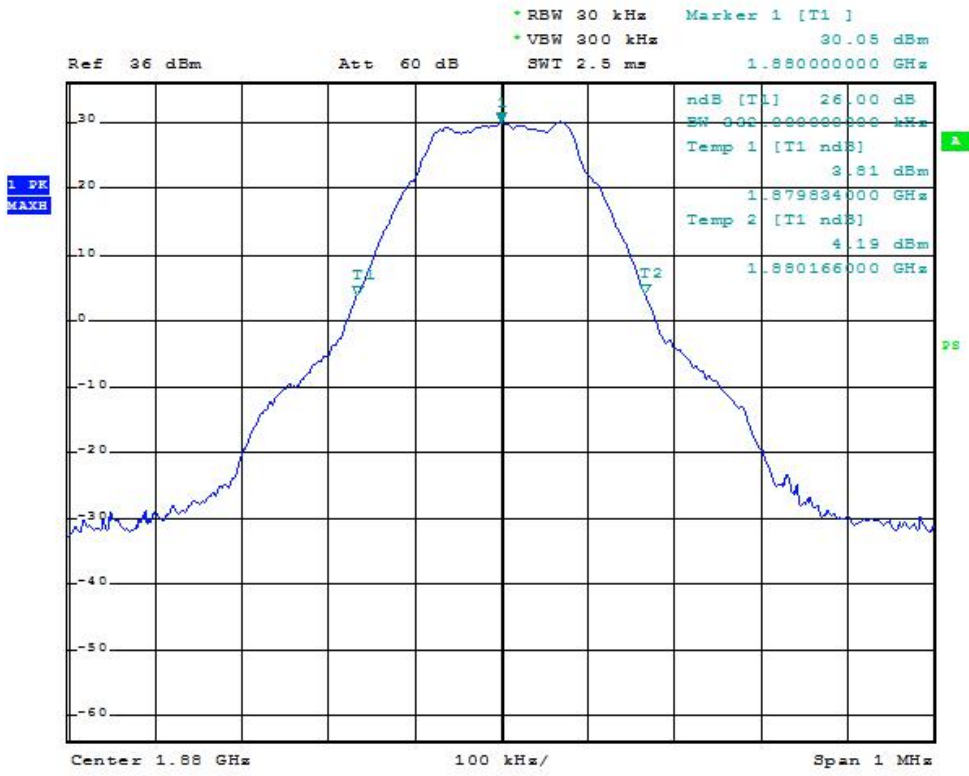

7. MODULATION CHARACTERISTIC

According to FCC § 2.1047(d), Part 22H & 24E there is no specific requirement for digital modulation, therefore modulation characteristic is not presented.

8. OUT OF BAND EMISSION AT ANTENNA TERMINALS

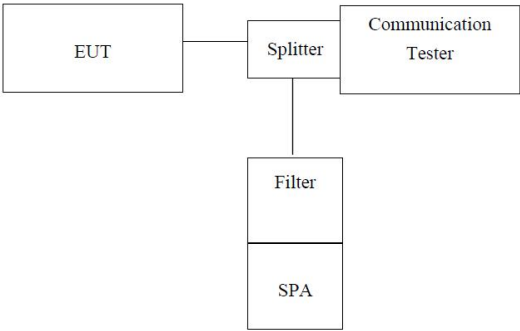
Test Requirement:	FCC part22.917(a) and FCC part24.238(a)
Test Method:	FCC part2.1051
Limit:	-13dBm
Test setup:	 <p><i>Note: Measurement setup for testing on Antenna connector</i></p>
Test Procedure:	<ol style="list-style-type: none"> 1 The RF output of the transceiver was connected to a spectrum analyzer through appropriate attenuation. 2 The resolution bandwidth of the spectrum analyzer was set at 1MHz, sufficient scans were taken to show the out of band Emissions if any up to 10th harmonic. 3 For the out of band: Set the RBW, VBW = 1MHz, Start=30MHz, Stop= 10th harmonic. 4 Band Edge Requirements: In the 1 MHz bands immediately outside and adjacent to the frequency block, a resolution bandwidth of at least 1 percent of the emission bandwidth of the fundamental emission of the transmitter may be employed to measure the out of band Emissions.
Test Instruments:	Refer to section 1.7 for details
Test mode:	Refer to section 1.2 for details
Test results:	Pass

Test plot as follows:

Note: During the conducted spurious emission test, a band filter was used. The information of the filter is reported at section 6.0 (refer to item 24, 25).

Only the worst case was selected to record

**For GSM 850:
30MHz-1000MHz - Middle Channel**

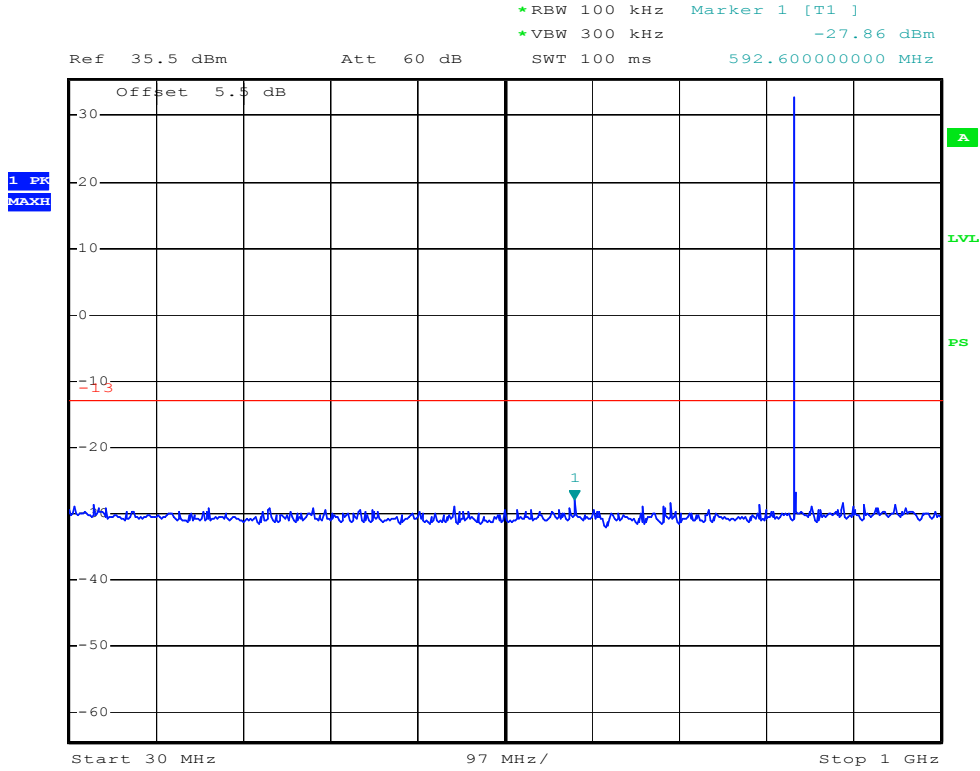

1GHz-3GHz - Middle Channel

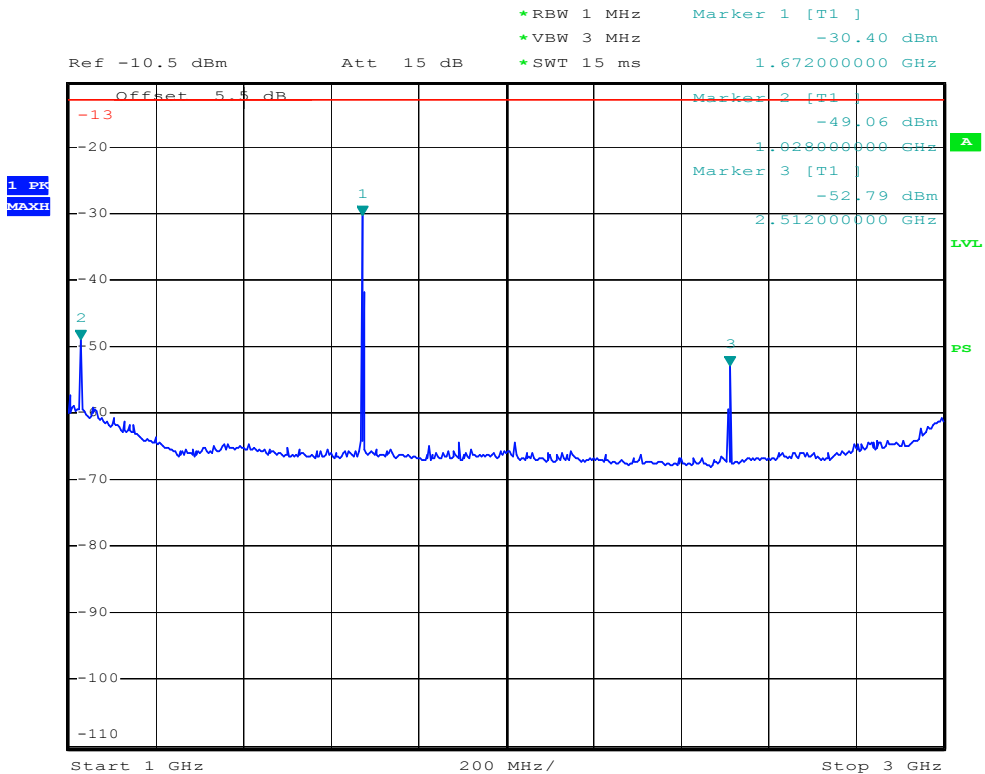

3GHz-10GHz - Middle Channel

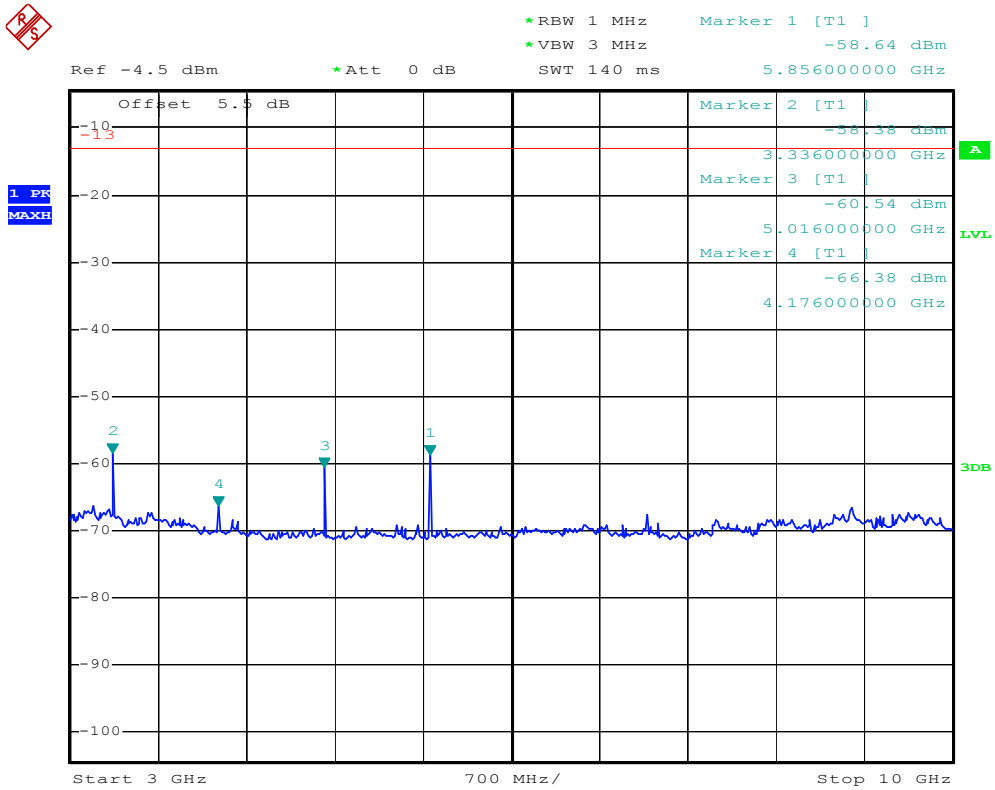

For PCS 1900:
30MHz-1000MHz - Middle Channel

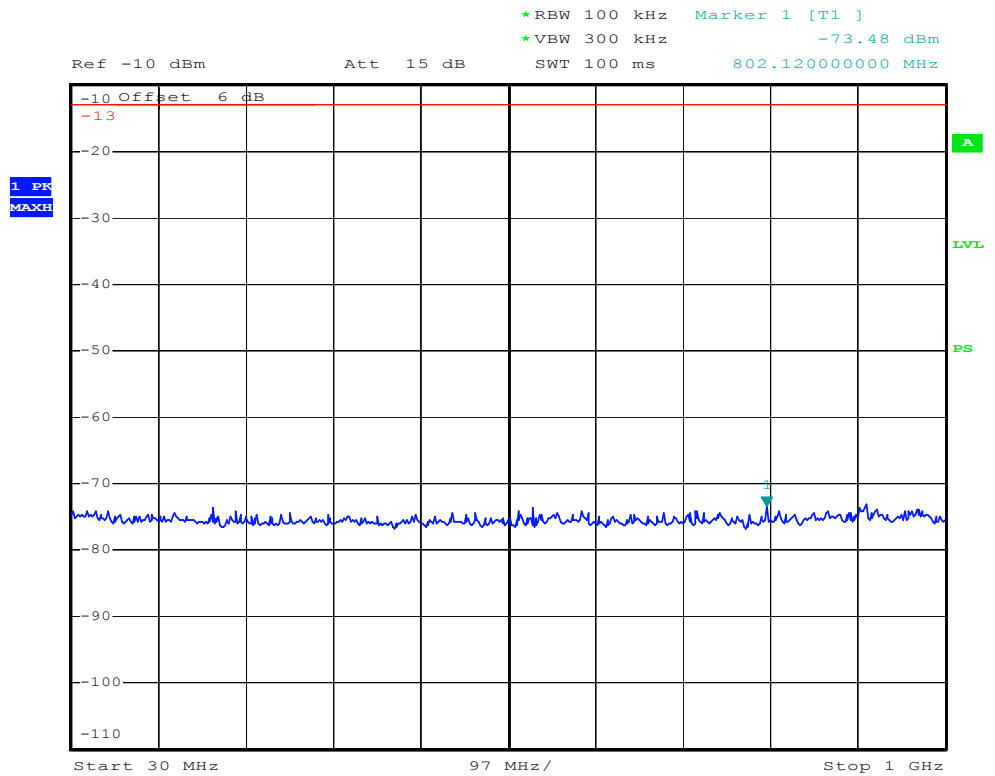

1GHz-3GHz - Middle Channel

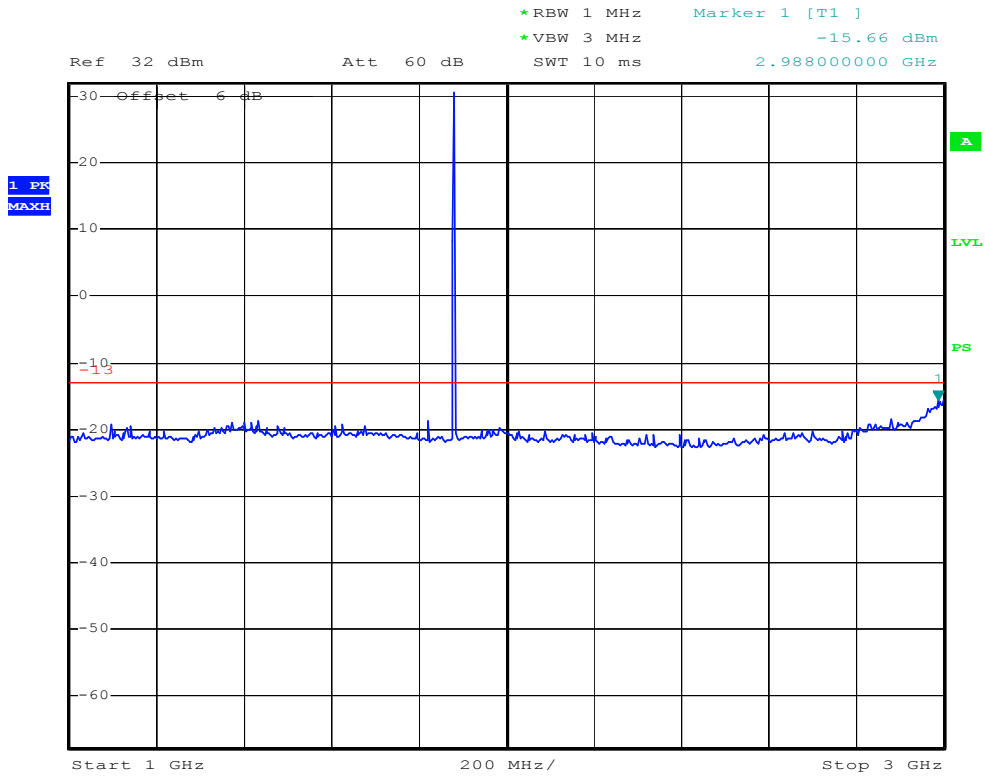

3GHz-13.6GHz - Middle Channel

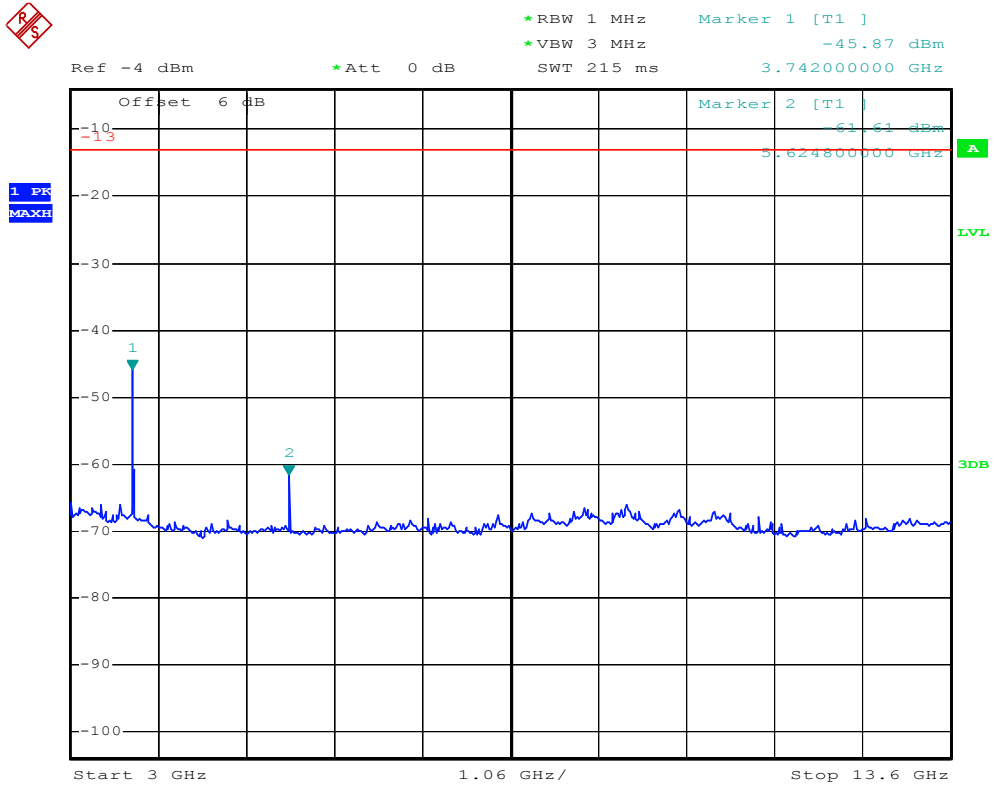

13.6GHz-20GHz - Middle Channel

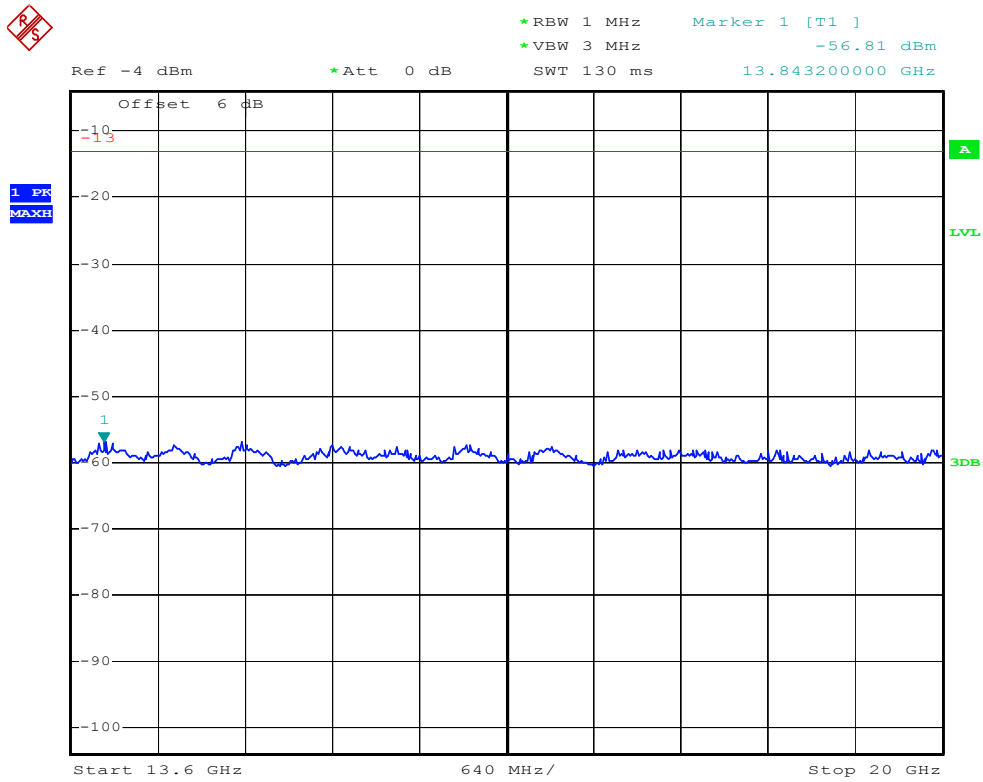

Band Edge:

Only the worst case was selected to record

For GSM 850

Frequency (MHz)	Emission (dBm)	Limit (dBm)
824	-15.76	-13
849	-15.25	-13

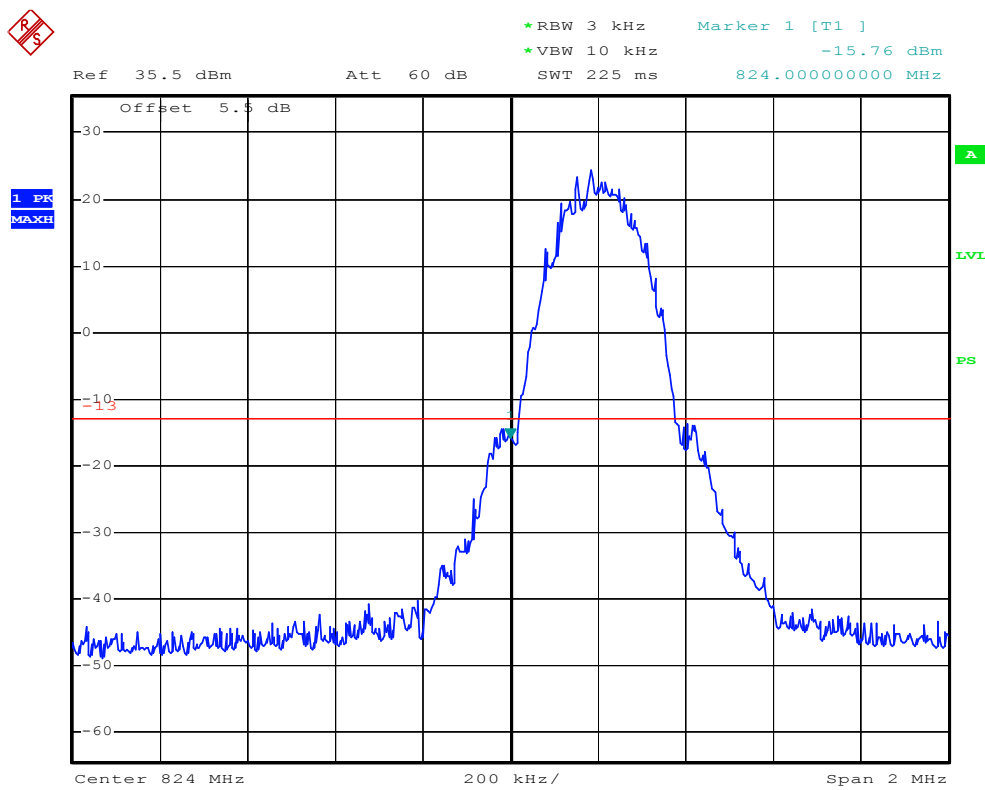

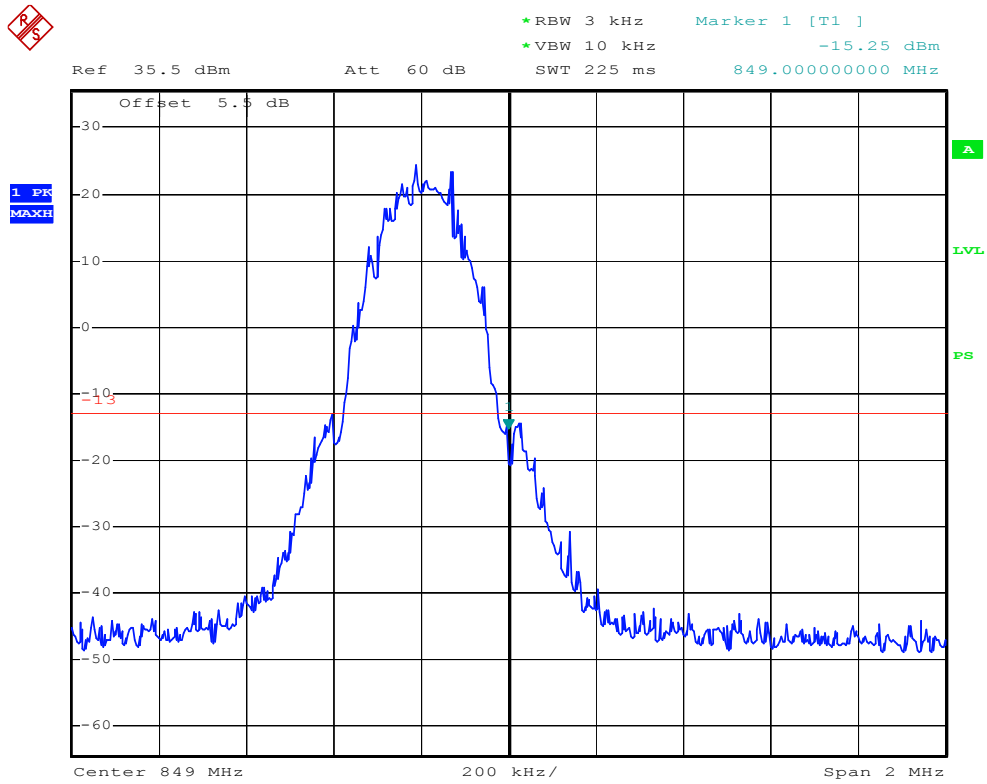

For PCS1900

Frequency (MHz)	Emission (dBm)	Limit (dBm)
1850	-16.88	-13
1910	-17.15	-13

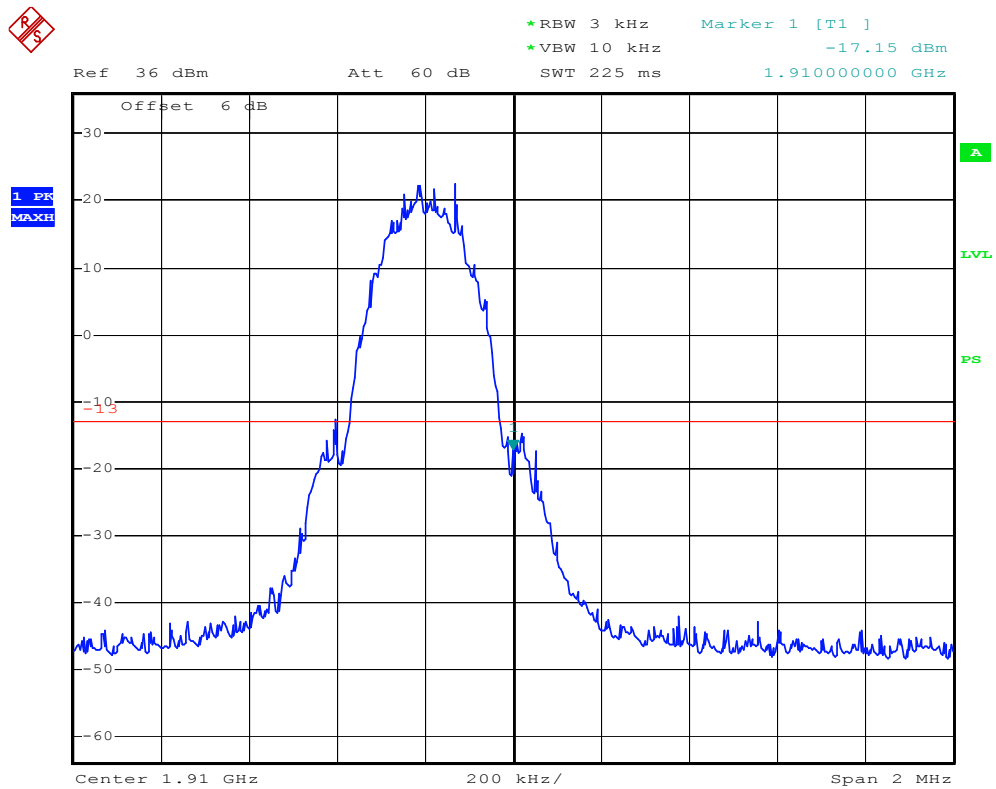
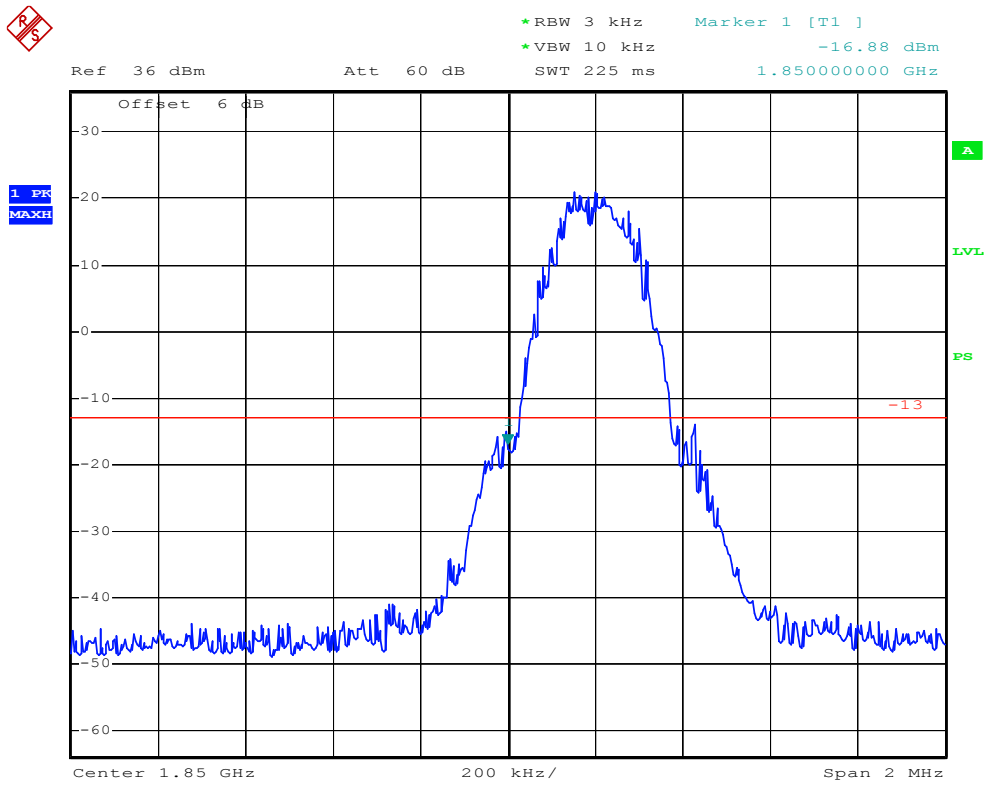

9. ERP, EIRP MEASUREMENT

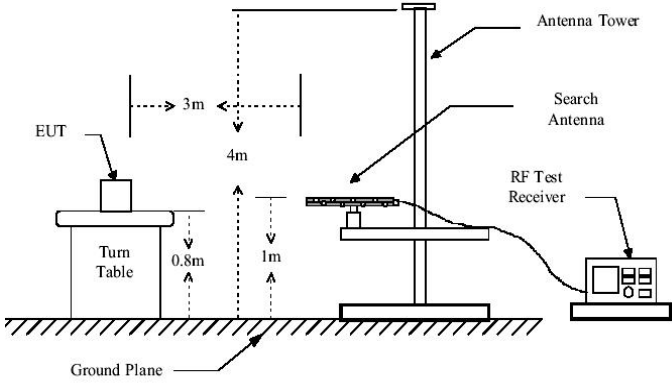
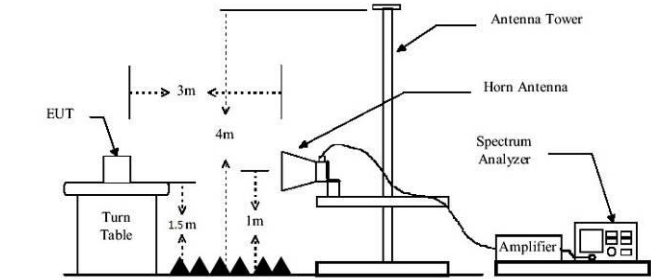
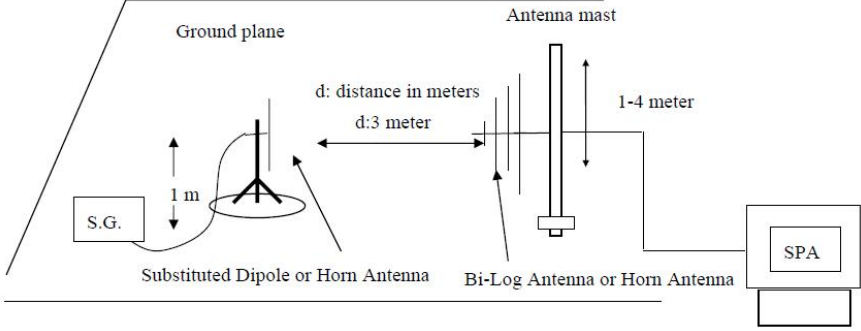
<p>Test Requirement:</p>	<p>FCC part22.913(a) and FCC part24.232(b)</p>
<p>Test Method:</p>	<p>FCC part2.1046</p>
<p>Limit:</p>	<p>GSM850, WCDMA Band V: 7W PCS1900, WCDMA Band II: 2W</p>
<p>Test setup:</p>	<p>Below 1GHz</p>  <p>Above 1GHz</p>  <p>Substituted method:</p> 

Test Procedure:	<ol style="list-style-type: none"> 1. The EUT was placed on an non-conductive turntable using a non-conductive support. The radiated emission at the fundamental frequency was measured at 3 m with a test antenna and EMI spectrum analyzer. 2. During the measurement, the EUT was communication with the station. The highest emission was recorded with the rotation of the turntable and the lowering of the test antenna from 4m to 1m. The reading was recorded and the field strength (E in dBuV/m) was calculated. 3. ERP in frequency band 824.2 –848.80.8MHz were measured using a substitution method. The EUT was replaced by dipole antenna connected, the S.G. output was recorded and ERP was calculated asfollows: $\text{ERP} = \text{S.G. output (dBm)} + \text{Antenna Gain (dBd)} - \text{Cable Loss (dB)}$ 4. EIRP in frequency band 1850.2 –1909.8MHz were measured using a substitution method. The EUT was replaced by or horn antenna connected, the S.G. output was recorded and EIRP was calculated as follows: $\text{EIRP} = \text{S.G. output (dBm)} + \text{Antenna Gain (dBi)} - \text{Cable Loss (dB)}$
Test Instruments:	Refer to section 1.7 for details
Test mode:	Refer to section 1.2 for details
Test results:	Pass

Measurement Data

EUT mode	Channel	EUT Pol.	Antenna Pol.	ERP(dBm)	Limit (dBm)	Result
GSM850 (GSM link)	Lowest	H	V	31.82	38.45	Pass
			H	28.67		
		E1	V	29.24		
			H	31.88		
		E2	V	28.67		
			H	30.72		
	Middle	H	V	31.96	38.45	Pass
			H	29.94		
		E1	V	38.54		
			H	31.94		
		E2	V	29.54		
			H	31.62		
	Highest	H	V	28.96	38.45	Pass
			H	31.97		
		E1	V	30.51		
			H	28.26		
		E2	V	31.86		
			H	29.64		

EUT mode	Channel	EUT Pol.	Antenna Pol.	ERP(dBm)	Limit (dBm)	Result
GSM850 (GPRS 1 link)	Lowest	H	V	30.78	38.45	Pass
			H	31.77		
		E1	V	30.54		
			H	29.84		
		E2	V	31.81		
			H	28.24		
	Middle	H	V	30.50	38.45	Pass
			H	31.88		
		E1	V	31.92		
			H	29.01		
		E2	V	30.21		
			H	30.14		
	Highest	H	V	31.92	38.45	Pass
			H	29.93		
		E1	V	28.84		
			H	31.95		
		E2	V	28.52		
			H	30.01		

EUT mode	Channel	EUT Pol.	Antenna Pol.	EIRP (dBm)	Limit (dBm)	Result
PCS1900 (GSM link)	Lowest	H	V	28.85	33.01	Pass
			H	27.42		
		E1	V	26.84		
			H	28.95		
		E2	V	27.51		
			H	26.84		
	Middle	H	V	27.31	33.01	Pass
			H	28.33		
		E1	V	27.65		
			H	25.02		
		E2	V	28.87		
			H	27.58		
	Highest	H	V	28.62	33.01	Pass
			H	26.27		
		E1	V	27.20		
			H	26.80		
		E2	V	26.11		
			H	28.94		

EUT mode	Channel	EUT Pol.	Antenna Pol.	EIRP (dBm)	Limit (dBm)	Result
PCS1900 (GPRS 1 link)	Lowest	H	V	26.43	33.01	Pass
			H	28.40		
		E1	V	27.82		
			H	26.54		
		E2	V	28.66		
			H	26.68		
	Middle	H	V	27.57	33.01	Pass
			H	28.49		
		E1	V	27.21		
			H	25.24		
		E2	V	28.74		
			H	26.95		
	Highest	H	V	26.51	33.01	Pass
			H	28.56		
		E1	V	26.84		
			H	27.95		
		E2	V	28.54		
			H	27.71		

10. FIELD STRENGTH OF SPURIOUS RADIATION MEASUREMENT

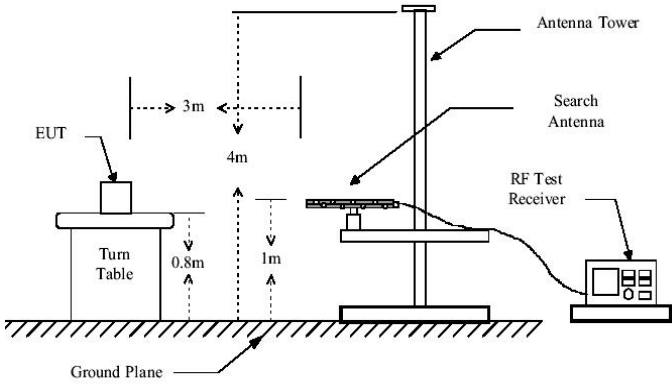
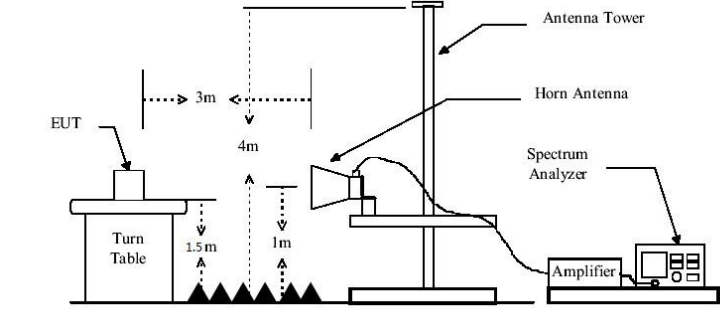
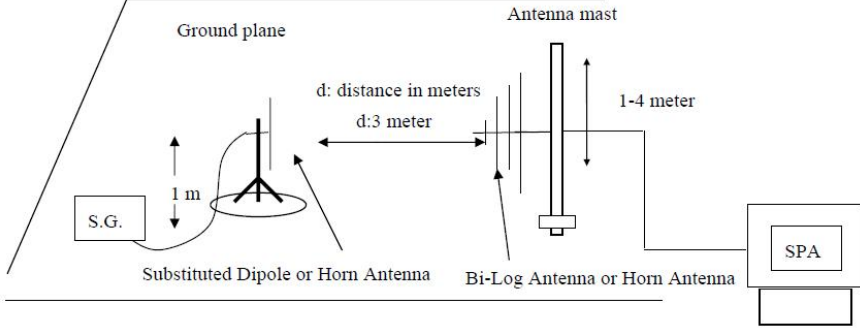
Test Requirement:	FCC part22.917(a) and FCC part24.238(a)
Test Method:	FCC part2.1053
Limit:	-13dBm
Test setup:	<p>Below 1GHz</p>  <p>Above 1GHz</p>  <p>Substituted method:</p> 

Test Procedure:	<ol style="list-style-type: none"> 1. The EUT was placed on an non-conductive turntable using a non-conductive support. The radiated emission at the fundamental frequency was measured at 3 m with a test antenna and EMI spectrum analyzer. 2. During the tests, the antenna height and the EUT azimuth were varied in order to identify the maximum level of emissions from the EUT. This maximization process was repeated with the EUT positioned in each of its three orthogonal orientations. 3. The frequency range up to tenth harmonic was investigated for each of three fundamental frequency (low, middle and high channels). Once spurious emission was identified, the power of the emission was determined using the substitution method. 4. The spurious emissions attenuation was calculated as the difference between radiated power at the fundamental frequency and the spurious emissions frequency. $\text{ERP / EIRP} = \text{S.G. output (dBm)} + \text{Antenna Gain(dB/dBi)} - \text{Cable Loss (dB)}$
Test Instruments:	Refer to section 1.7 for details
Test mode:	Refer to section 1.2 for details
Test results:	Pass

Measurement Data

Test mode:	GSM850		Test channel:	Lowest
Frequency (MHz)	Spurious Emission		Limit (dBm)	Result
	Polarization	Level (dBm)		
1648.40	Vertical	-35.35	-13.00	Pass
2472.60	V	-38.65		
3296.80	V	-39.95		
4121.00	V	-42.65		
4945.20	V	---		
1648.40	Horizontal	-40.65	-13.00	Pass
2472.60	H	-44.54		
3296.80	H	-46.84		
4121.00	H	-48.95		
4945.20	H	---		
Test mode:	GSM850		Test channel:	Middle
Frequency (MHz)	Spurious Emission		Limit (dBm)	Result
	Polarization	Level (dBm)		
1673.20	Vertical	-36.95	-13.00	Pass
2509.80	V	-39.65		
3346.40	V	-40.35		
4183.00	V	-42.54		
5019.60	V	---		
1673.20	Horizontal	-40.68	-13.00	Pass
2509.80	H	-44.94		
3346.40	H	-45.57		
4183.00	H	-47.84		
5019.60	H	---		
Test mode:	GSM850		Test channel:	Highest
Frequency (MHz)	Spurious Emission		Limit (dBm)	Result
	Polarization	Level (dBm)		
1697.60	Vertical	-36.98	-13.00	Pass
2546.40	V	-38.54		
3395.20	V	-40.84		
4244.00	V	-41.52		
5092.80	V	---		
1697.60	Horizontal	-39.63	-13.00	Pass
2546.40	H	-43.24		
3395.20	H	-44.58		
4244.00	H	-46.49		
5092.80	H	---		

Remark :

1. The emission behaviour belongs to narrowband spurious emission.
2. Remark"---" means that the emission level is too low to be measured
3. The emission levels of below 1 GHz are very lower than the limit and not show in test report.

Test mode:	PCS1900		Test channel:	Lowest
Frequency (MHz)	Spurious Emission		Limit (dBm)	Result
	Polarization	Level (dBm)		
3700.40	Vertical	-34.69	-13.00	Pass
5550.60	V	-38.84		
7400.80	V	-39.52		
9251.00	V	-41.47		
11101.20	V	---		
3700.40	Horizontal	-39.68	-13.00	Pass
5550.60	H	-43.95		
7400.80	H	-44.34		
9251.00	H	-46.84		
11101.20	H	---		
Test mode:	PCS1900		Test channel:	Middle
Frequency (MHz)	Spurious Emission		Limit (dBm)	Result
	Polarization	Level (dBm)		
3760.00	Vertical	-33.95	-13.00	Pass
5640.00	V	-35.58		
7520.00	V	-37.12		
9400.00	V	-39.01		
11280.00	V	---		
3760.00	Horizontal	-37.62	-13.00	Pass
5640.00	H	-41.35		
7520.00	H	-42.84		
9400.00	H	-44.95		
11280.00	H	---		
Test mode:	PCS1900		Test channel:	Highest
Frequency (MHz)	Spurious Emission		Limit (dBm)	Result
	Polarization	Level (dBm)		
3819.60	Vertical	-33.95	-13.00	Pass
5729.40	V	-36.68		
7639.20	V	-38.84		
9549.00	V	-39.57		
11458.80	V	---		
3819.60	Horizontal	-39.84	-13.00	Pass
5729.40	H	-42.95		
7639.20	H	-43.65		
9549.00	H	-45.34		
11458.80	H	---		

Remark:

1. The emission behaviour belongs to narrowband spurious emission.
2. Remark"---" means that the emission level is too low to be measured
3. The emission levels of below 1 GHz are very lower than the limit and not show in test report.

11. FREQUENCY STABILITY V.S. TEMPERATURE MEASUREMENT

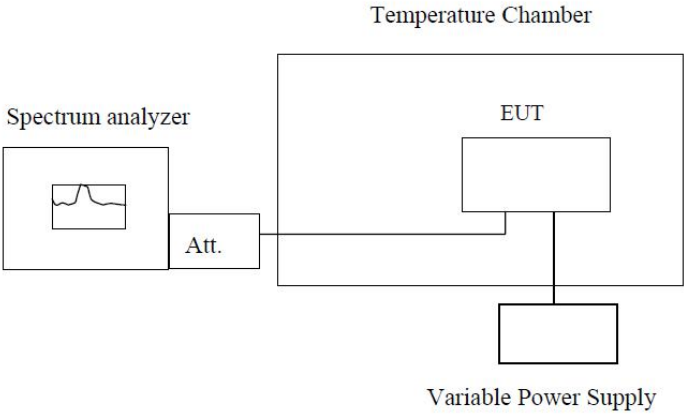
Test Requirement:	FCC Part2.1055(a)(1)(b)
Test Method:	FCC Part2.1055(a)(1)(b)
Limit:	2.5ppm
Test setup:	 <p style="text-align: center;">Note : Measurement setup for testing on Antenna connector</p>
Test procedure:	<ol style="list-style-type: none"> 1. The equipment under test was connected to an external DC power supply and input rated voltage. 2. RF output was connected to a frequency counter or spectrum analyzer via feed through attenuators. 3. The EUT was placed inside the temperature chamber. 4. Set the spectrum analyzer RBW low enough to obtain the desired frequency resolution and measure EUT 25°C operating frequency as reference frequency. 5. Turn EUT off and set the chamber temperature to -20°C. After the temperature stabilized for approximately 30 minutes recorded the frequency. 6. Repeat step measure with 10°C increased per stage until the highest temperature of +50°C reached.
Test Instruments:	Refer to section 1.7 for details
Test mode:	Refer to section 1.2 for details
Test results:	Pass

Measurement Data

Reference Frequency: GSM850 (GSM link) Middle channel=190 channel=836.6MHz					
Power supplied (Vdc)	Temperature (°C)	Frequency error		Limit (ppm)	Result
		Hz	ppm		
3.70	-30	12	0.0143	2.5	Pass
	-20	2	0.0024		
	-10	6	0.0072		
	0	-10	-0.0120		
	10	-4	-0.0048		
	20	-8	-0.0096		
	30	-11	-0.0131		
	40	-13	-0.0155		
	50	-10	-0.0120		
Reference Frequency: GSM850 (GPRS 1 link) Middle channel=190 channel=836.6MHz					
Power supplied (Vdc)	Temperature (°C)	Frequency error		Limit (ppm)	Result
		Hz	ppm		
3.70	-30	8	0.0096	2.5	Pass
	-20	5	0.0060		
	-10	4	0.0048		
	0	-5	-0.0060		
	10	-9	-0.0108		
	20	-12	-0.0143		
	30	-16	-0.0191		
	40	-10	-0.0120		
	50	-13	-0.0155		

Reference Frequency: PCS1900 (GSM link) Middle channel=661 channel=1880MHz					
Power supplied (Vdc)	Temperature (°C)	Frequency error			Result
		Hz	ppm		
3.70	-30	-50	-0.0266	2.5	Pass
	-20	-42	-0.0223		
	-10	-49	-0.0261		
	0	-53	-0.0282		
	10	-65	-0.0346		
	20	-74	-0.0394		
	30	-69	-0.0367		
	40	-86	-0.0457		
	50	-48	-0.0255		
Reference Frequency: PCS1900 (GPRS 1 link) Middle channel=661 channel=1880MHz					
Power supplied (Vdc)	Temperature (°C)	Frequency error			Result
		Hz	ppm		
3.70	-30	-57	-0.0303	2.5	Pass
	-20	-48	-0.0255		
	-10	-58	-0.0309		
	0	-50	-0.0266		
	10	-78	-0.0415		
	20	-83	-0.0442		
	30	-88	-0.0468		
	40	-65	-0.0346		
	50	-90	-0.0479		

12. FREQUENCY STABILITY V.S. VOLTAGE MEASUREMENT

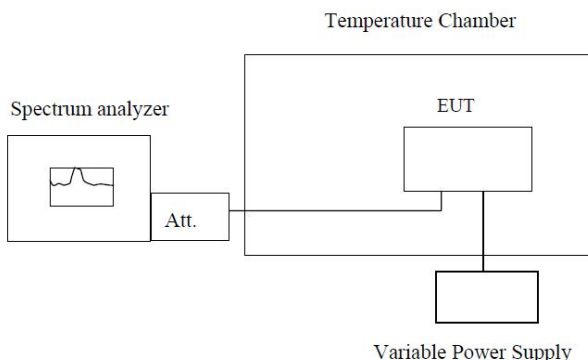
Test Requirement:	FCC Part2.1055(d)(1)(2)
Test Method:	FCC Part2.1055(d)(1)(2)
Limit:	2.5ppm
Test setup:	 <p style="text-align: center;">Temperature Chamber</p> <p style="text-align: center;">Spectrum analyzer</p> <p style="text-align: center;">Att.</p> <p style="text-align: center;">EUT</p> <p style="text-align: center;">Variable Power Supply</p> <p>Note : Measurement setup for testing on Antenna connector</p>
Test procedure:	<ol style="list-style-type: none"> 1. Set chamber temperature to 25°C. Use a variable DC power source to power the EUT and set the voltage to rated voltage. 2. Set the spectrum analyzer RBW low enough to obtain the desired frequency resolution and recorded the frequency. 3. Reduce the input voltage to specified extreme voltage variation (+/- 15%) and endpoint, record the maximum frequency change.
Test Instruments:	Refer to section 1.7 for details
Test mode:	Refer to section 1.2 for details
Test results:	Pass

Measurement Data

Reference Frequency: GSM850 (GSM link) Middle channel=190 channel=836.6MHz					
Temperature (°C)	Power supplied (Vdc)	Frequency error		Limit (ppm)	Result
		Hz	ppm		
25	4.25	50	0.0598	2.5	Pass
	3.7	54	0.0645		
	3.4	62	0.0741		
Reference Frequency: GSM850 (GPRS 1 link) Middle channel=190 channel=836.6MHz					
Temperature (°C)	Power supplied (Vdc)	Frequency error		Limit (ppm)	Result
		Hz	ppm		
25	4.25	41	0.0490	2.5	Pass
	3.7	35	0.0418		
	3.4	41	0.0490		
Reference Frequency: PCS1900 (GSM link) Middle channel=661 channel=1880MHz					
Temperature (°C)	Power supplied (Vdc)	Frequency error		Limit (ppm)	Result
		Hz	ppm		
25	4.25	52	0.0277	2.5	Pass
	3.7	51	0.0271		
	3.4	48	0.0255		
Reference Frequency: PCS1900 (GPRS 1 link) Middle channel=661 channel=1880MHz					
Temperature (°C)	Power supplied (Vdc)	Frequency error		Limit (ppm)	Result
		Hz	ppm		
25	4.25	43	0.0229	2.5	Pass
	3.7	41	0.0218		
	3.4	52	0.0277		

-----End-----