

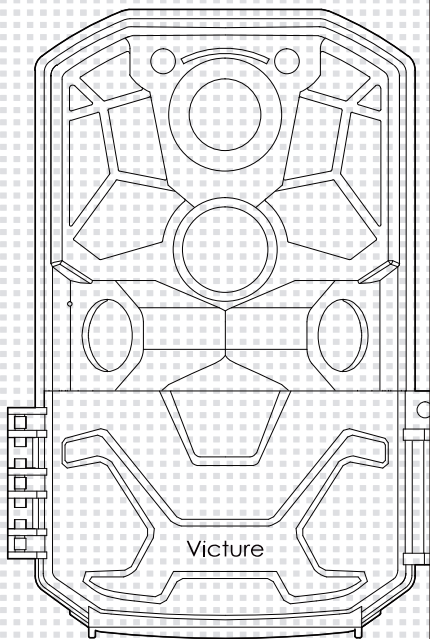

Victure

User Manual



HC500

Wi-Fi Trail Camera

Language

English 02 - 19

Customer Service

Warranty & Customer Support

Please send Order Screenshot to our **Warranty Team** Email **vip@govicture.com** for extending the warranty to 36 months! Lifetime professional tech support provided by Victure.

If you have encountered any problem or have any question and suggestion for our camera, please do not hesitate to contact our **Customer Support Team** Email **hc.support@govicture.com** for help firstly. We are always here!

Need More Operational Video?

- ① Get E-manual from our **Customer Support Team** (Email: **hc.support@govicture.com**).
- ② Search 'Victure TC' on YouTube, enter into the brand page and then click the 'PLAYLISTS'.
- ③ Scan the QR code below directly.



Main Product Parameters

EN

Photo Resolution	30MP (MAX)
Video Resolution	1296P (MAX) 1728×1296p@30fps
WIFI	2.4 ~ 2.5 GHz 802.11 b/g/n (High-speed up to 150 Mbps)
Bluetooth 5.0	Low Power Consumption + 2.4GHz ISM
Distance of connecting WIFI and Bluetooth	40m (MAX)
Consecutive Shots No.	1 - 10 Photos
Wide Angle	120°
Lens	f=4.3mm F/NO=2.0; FOV=88 °
Trigger Time	0.2~0.4s
Waterproof Level	IP66
IR LEDs	36 PCS 850nm IR LEDs
SD/SDHC Card	Support 4~ 128GB (MAX); Support Class 6 ~ Class 10
USB Port	2.0 USB
Voltage	8 AA Battery DC :6V-2.0A
Working Temperature	-10-60℃
LCD Screen	2.0" 320(RGB)x240 DOT
Product Size	140*96*78mm N.W: 321g
Accessories	HC500*1; User Manual*1; Belt*1; USB*1, Tripod*1 (Battery and SD card are not included.)

Product Structure

EN

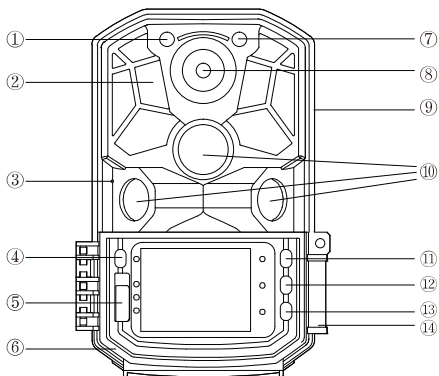

- | | |
|-----------------|-----------------------------|
| ① Red/Blue LED | ⑧ Lens |
| ② IR LEDs | ⑨ Speaker |
| ③ Video Mic | ⑩ PIR Sensor |
| ④ MODE/ESC | ⑪ WIFI Button |
| ⑤ Switch Button | ⑫ OK Button |
| ⑥ Rubber Ring | ⑬ Photo/Video Switch Button |
| ⑦ Light Sensor | ⑭ Locking Bracket |

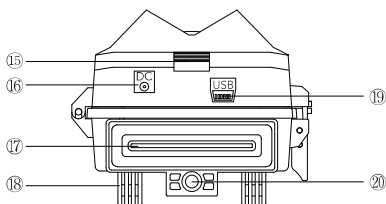

⑮ Battery Open Button

⑯ DC In

⑰ Battery Compartment

⑱ Belt Installation

⑲ USB Port

⑳ 1/4 Inch Nut Port

Preparation for Using

1. Tear off the Protective Films before use.
2. Confirm that camera is in OFF mode in the beginning. Then install 8AA LR6 Alkaline Battery and Class 6 ~ 10 SD card.

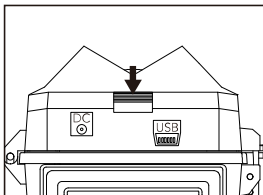

① Press Battery Compartment Button

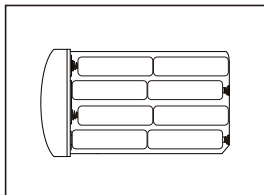

② Place 8AA Batteries

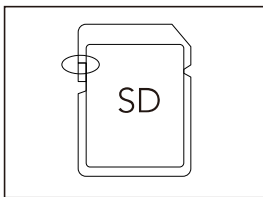

③ Before insert SD card, please make sure that SD is in unlock state.

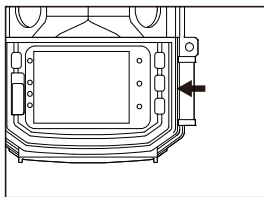

④ Insert SD card

- ⚠** ① Camera supports 4~128GB SD card. Before first using, please format SD card to 'FAT32' format.
If need to format to 'FAT32' format, please use your computer to format.
- ② If only use 4 AA Batteries, please place them in right/ left two rows. Please don't place 4AA batteries in middle two

3. Format SD card and default camera before use.

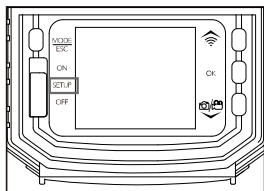

① Slide switch to SETUP

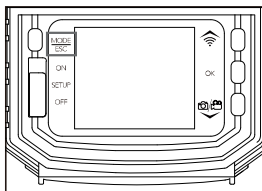

② Short press 'MODE/ESC' Button twice

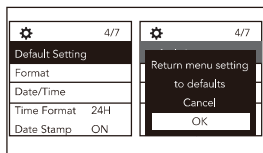

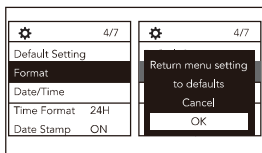

③ Default Setting







④ Format SD card

Function Description of the Buttons



In Photo/Video Standby Mode (Turn TEST mode, camera will enter 'Photo/Video Standby Mode' firstly.)

	Each press will cycle switch from Photo/Video Standby Mode to Replay Mode and Menu Setting.
	Turn ON or Turn OFF WIFI.
OK	First press will start to take photos/videos. Second press will stop taking photos/videos.
	Switch between Photo and Video Mode.

In Replay Mode (Press  once, camera will enter 'Replay Mode'.)

	1.Each press will cycle switch from Photo/Video Standby Mode to Replay Mode and Menu Setting. 2.Function of Exit/Cancel.
	1.Replay last photos/videos. 2.Speed up video replaying.
OK	1.Short press will start or stop video replaying. 2.Long press to delete all photos/videos.
	1.Replay next photos/videos. 2.Rewind video replaying.

In MENU Setting Mode (Press $\frac{\text{MODE}}{\text{ESC}}$ twice, camera will enter 'MENU Setting Mode'.)

$\frac{\text{MODE}}{\text{ESC}}$	1.Each press will cycle switch from Photo/Video Standby Mode to Replay Mode and Menu Setting. 2.Exit/Cancel function.
	Move the option up or add the value.
OK	Open one of settings which you chose or save your setting.
	Move the option down or decline the value.

Connect to Bluetooth (BLE) and WIFI

1.Scan QR code and download latest 'Hunting Camera Pro' APP to your smart phone. Or input 'Hunting Camera Pro' to search latest APP in Google Play or APP Store directly.



IOS



Android

*After installed APP, please set your favorite WIFI name and password.

Original WIFI name: **Victure*****('Victure'+Random Code)**

Original WIFI password: **12345678**

Beginning of original Bluetooth name:

CAMERA-***('CAMERA-'+Random Code)**

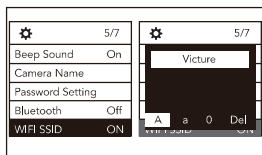

① Find 'WIFI SSID' and then set your WIFI name

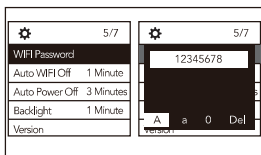

② Find 'WIFI Password' and then set your password

2. Use Bluetooth(BLE) to switch camera WIFI ON and connect WIFI in APP.

a. Turn camera to ON or TEST mode, then open APP and connect BLE.

*Before connect to BLE in APP, please confirm that you have set 'Bluetooth' to 'ON' mode in camera settings and switched Bluetooth ON in your phone. Otherwise, you cannot search out BLE and connect in APP.

b. If you have connected BLE and WIFI successfully in TEST mode, please switch camera from TEST to ON mode directly. Please don't switch camera from TEST to OFF mode and then turn ON camera. It will close WIFI.

c. In TEST mode, you can also turn ON WIFI manually by press  .
(Screenshot below are from Android. If your phone is IOS system, please operate according to actual situation.)

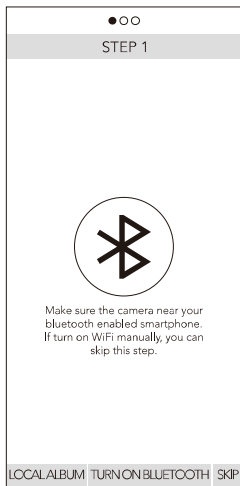

① Open APP. Then choose 'TURN ON BLUETOOTH'.

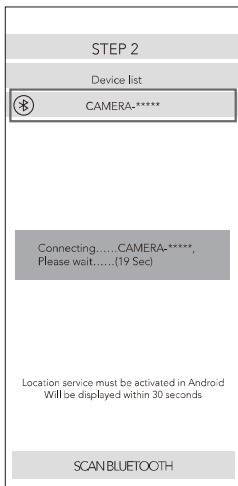

② Search and find correct BLE name and then connect.

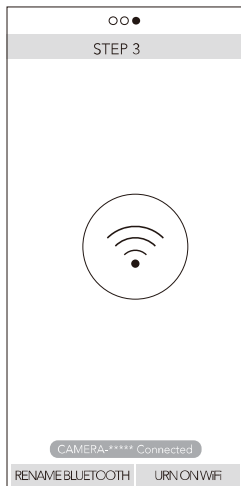

③ 'TURN ON WiFi'. You can also Change BLE name here.

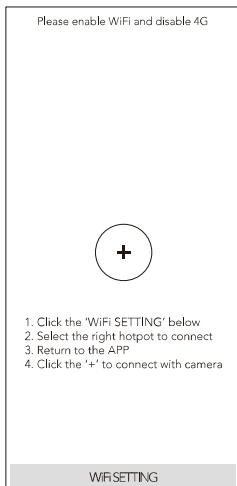

④ Press 'WiFi SETTING' and choose correct WiFi. Then back to APP.

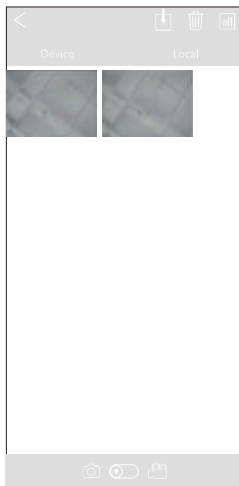

⑤ Successfully connected.

⚠ If any problem for WIFI and BLE connecting, please do not hesitate to ask Customer Support Team for help.
Or find operation video from 'Victure TC' on YouTube.
(Email: hc.support@govicture.com)

3. Switch WIFI ON and connect WIFI directly without Bluetooth.

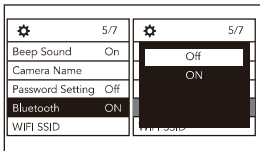

① Set 'Bluetooth' Off.

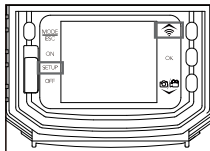

② Turn to TEST mode and then press WIFI button directly.

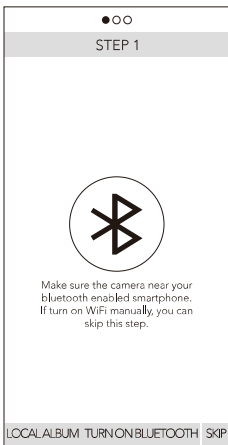







③ Turn ON APP and press 'SKIP' and then connect WIFI directly. After connected WIFI successfully, please turn camera from TEST to ON directly.





▲ Differences between switching WIFI ON with BLE and without BLE:

① With BLE, you can switch WIFI ON and connect WIFI directly even though camera is in ON mode and working.

② Without BLE, it just can switch WIFI ON in TEST mode manually. When camera is in ON mode and working, press cannot switch WIFI ON.

Notice: When camera show blue WIFI image, screen will change or turn off after minutes according to your setting of 'Backlight' time.

EXIT	Press 'EXIT'. APP will close. WIFI and BLE will also close.
	WIFI and BLE status
	Power of camera battery. It may be different to actual percentage power in camera. It is normal because of battery discharge.
	Change to Video mode
	Change to Photo mode
	Preview photos/videos from this camera in your mobile phone directly. Please download them to your phone and then preview.
	Press this button, take photos/videos manually.
	Change camera settings in your mobile phone.

		Download photos/videos to mobile album.
		Delete photos/videos. Once delete, they cannot be recovered again.
		Choose all photos and videos.
		Switch to photo or video album to preview.

FAQ

▲ Cautions:

If there is any problem or suggestion with the product, please feel free to contact our Customer Support Team Email hc.support@govicture.com timely. We are always the Superman around you!

Camera screen turn OFF after countdown 5 seconds in ON mode?

① It is normal. Camera is entering working mode after countdown 5 seconds.

Can not turn on or turn off automatically?

① Confirm whether you have inserted 8AA full power batteries. Make sure that the positive and negative poles of the battery are installed correctly.

② Take out all batteries for 3 minutes and then insert again to check.

③ Set OFF 'Auto Power Off'.

Can not take photos/videos at night?

① Check whether you have set Time Switch.

② Check battery power. If power is lower than 30%, camera may not take photo/videos at night.

③ Check whether SD card is full or you have inserted correct SD card.

Card Error or Card Protected?

① Check whether SD card is FAT32 format and Class 6 ~ Class 10.

② Check correct read and write position in SD card.

Forgot camera Password?

- ① Try 'OPEN'.

Can not connect WIFI/BLE?

- ① Check whether you have input correct WIFI password and find correct BLE.
- ② Exit APP and open again.
- ③ Default camera and then try with original password '12345678'.

FCC WARNING:

This equipment has been tested and found to comply with the limits for a Class B digital device, pursuant to part 15 of the FCC Rules. These limits are designed to provide reasonable protection against harmful interference in a residential installation. This equipment generates, uses and can radiate radio frequency energy and, if not installed and used in accordance with the instructions, may cause harmful interference to radio communications. However, there is no guarantee that interference will not occur in a particular installation. If this equipment does cause harmful interference to radio or television reception, which can be determined by turning the equipment off and on, the user is encouraged to try to correct the interference by one or more of the following measures:

- Reorient or relocate the receiving antenna.
- Increase the separation between the equipment and receiver.
- Connect the equipment into an outlet on a circuit different from that to which the receiver is connected.
- Consult the dealer or an experienced radio/TV technician for help.

Caution: Any changes or modifications to this device not explicitly approved by manufacturer could void your authority to operate this equipment.

This device complies with part 15 of the FCC Rules. Operation is subject to the following two conditions:

(1) This device may not cause harmful interference, and (2) this device must accept any interference received, including interference that may cause undesired operation.

This equipment complies with FCC radiation exposure limits set forth for an uncontrolled environment. This equipment should be installed and operated with minimum distance 20cm between the radiator and your body.