

Getting started with PowerPic mod

What's in the Box

- A PowerPic Charger
- B PowerPic Base
- C 5ft USB-C Power Cable

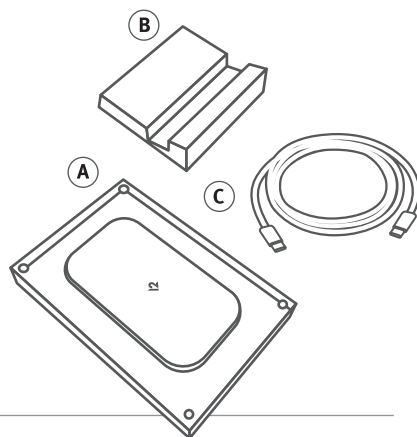

Setting up your PowerPic mod

PowerPic mod looks great by itself - but if you would like to add a graphic or pic first, see "Adding a photo or artwork" first, then return to the setup

1. Gently insert the PowerPic Charger into the PowerPic Base as shown. The PowerPic Charger can be placed in portrait or landscape positions

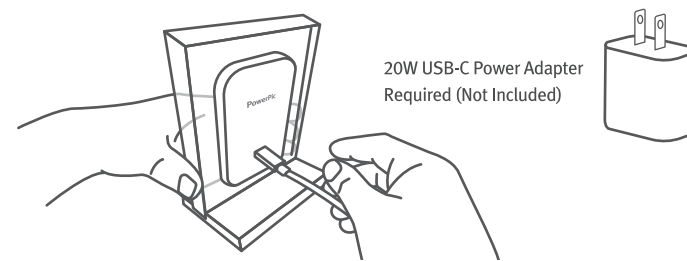
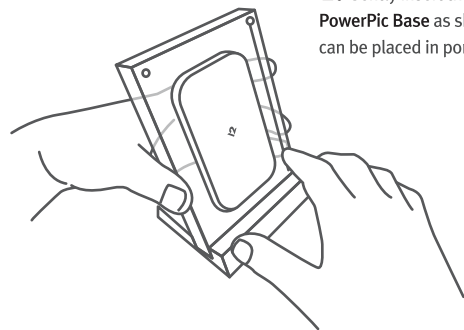

2. Plug the 5ft USB-C Power Cable into the PowerPic Charger and then into any 20W USB-C charger (USB-C charger not included).

Charging options & positions

PowerPic mod can charge most mobile phones in three optional positions: 1) frame portrait/phone portrait 2) frame portrait/phone landscape 3) frame landscape/phone landscape.

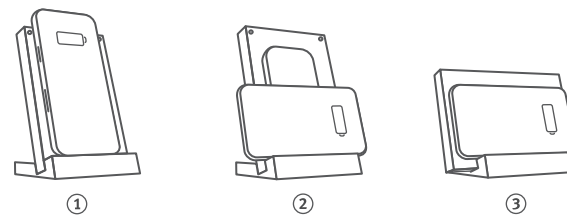

PowerPic status light

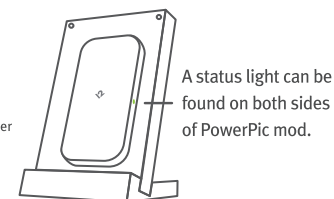

Adding a photo or artwork

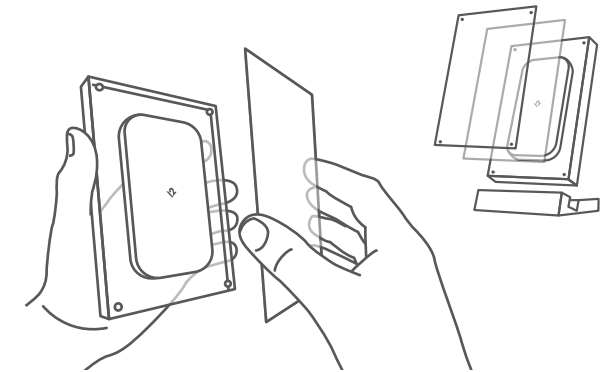

1. Gently pull the PowerPic Charger front plate from its magnetic fasteners.

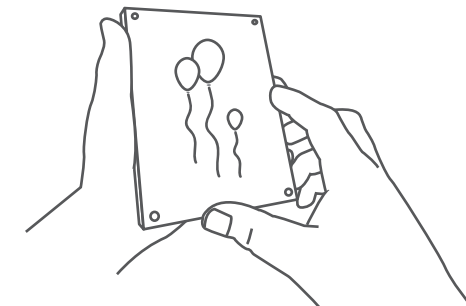

2. Place your 4x6 image or pattern onto the PowerPic Charger and then return the front plate to its magnetic fasteners.

Additional notes & specs

The foreign object detection light alerts you to objects between your device and PowerPic that could affect charging. This helps to prevent the charger from emitting unnecessary power and heat that could damage your smartphone and other heat-sensitive items.

To prevent overheating and damage to your PowerPic or device:

- Do not place any foreign objects, such as metal or magnets, between the phone and PowerPic. This may interfere with charging, causing overheating or damage to the device.
- Do not place any magnetic stripes or IC chip card on the PowerPic. This may cause damage.
- Do not cover the charging base with any material or cloth. This may interfere with charging performance.
- Do not let dust accumulate on the charging stand and keep the surface clean.

FCC ID Statement

This equipment complies with Part 15 of the FCC Rules. Operation is subject to the following two conditions: This device may not cause harmful interference, and This device must accept any interference received, including interference that may cause undesired operation.

Any changes or modifications not expressly approved by the party responsible for compliance could void the user's authority to operate this equipment.

IC Statement

Disclaimer: Operation is subject to the following two conditions: This device may not cause interference, and This device must accept any interference, including interference that may cause undesired operation of the device.

PowerPic Charging Plate Tech Specs

Input connector: USB Type C
Note: Included cable is 1.5m USB Type C to USB Type C

Input: 5V/2A 9V/1.67A
Output: 5W/7.5W/10W
Operation Frequency: 110.6 ~ 146.6 KHZ
Modulation type: CVS
Antenna Type: Coil Antenna
Charging efficiency: ≥72%



FCC ID: 2AREB-12-2019
IC: 24385-122019

ISED compliance statement

This device contains licence-exempt transmitter(s)/receiver(s) that comply with Innovation, Science and Economic Development Canada's licence-exempt RSS(s). Operation is subject to the following two conditions:

- (1) This device may not cause interference.
- (2) This device must accept any interference, including interference that may cause undesired operation of the device.

L' émetteur/récepteur exempt de licence contenu dans le présent appareil est conforme aux CNR d' Innovation, Sciences et Développement économique Canada applicables aux appareils radio exempts de licence. L' exploitation est autorisée aux deux conditions suivantes :

- (1) L' appareil ne doit pas produire de brouillage;
- (2) L' appareil doit accepter tout brouillage radioélectrique subi, même si le brouillage est susceptible d' en compromettre le fonctionnement.

ISED Radiation Exposure statement

This equipment complies with IC RSS-102 radiation exposure limits set forth for an uncontrolled environment. This equipment should be installed and operated with minimum distance 10cm between the radiator and your body. Cet équipement est conforme aux limites d'exposition aux radiations IC CNR-102 établies pour un environnement non contrôlé. Cet équipement doit être installé et utilisé avec une distance minimale de 10cm entre le radiateur et votre corps.

This equipment has been tested and found to comply with the limits for a Class B digital device, pursuant to Part 15 of the FCC Rules. These limits are designed to provide reasonable protection against harmful interference in a residential installation.

This equipment generates, uses and can radiate radio frequency energy and, if not installed and used in accordance with the instructions, may cause harmful interference to radio communications. However, there is no guarantee that interference will not occur in a particular installation.

If this equipment does cause harmful interference to radio or television reception, which can be determined by turning the equipment off and on, the user is encouraged to try to correct the interference by one or more of the following measures:

- Reorient or relocate the receiving antenna.
- Increase the separation between the equipment and receiver.
- Connect the equipment into an outlet on a circuit different from that to which the receiver is connected.
- Consult the dealer or an experienced radio/TV technician for help.

FCC Radiation Exposure statement

This equipment complies with FCC radiation exposure limits set forth for an uncontrolled environment. This equipment should be installed and operated with minimum distance 20cm between the radiator and your body. This transmitter must not be co-located or operating in conjunction with any other antenna or transmitter.

PowerPic mod owner's guide

