



KingSmith Smart Foldable Treadmill User Manual

Read all instructions before using this appliance.



800642



FCC ID: 2ARDB-TRT12F



Manufacturer: Beijing Kingsmith Technology Co., Ltd.

Address: Floor 4, Building 25, Area 18, ABP Park, Fengtai, Beijing, China.

MADE IN CHINA

Model No. : **TRK12F**

IMPORTANT SAFETY INSTRUCTIONS

Caution: The user is cautioned that changes or modifications not expressly approved by the party responsible for compliance could void the user's authority to operate the equipment.

This device complies with Part 15 of the FCC Rules. Operation is subject to the following two conditions: (1) this device may not cause harmful interference, and (2) this device must accept any interference received, including interference that may cause undesired operation.

NOTE: This equipment has been tested and found to comply with the limits for a Class B digital device, pursuant to Part 15 of the FCC Rules. These limits are designed to provide reasonable protection against harmful interference in a residential installation. This equipment generates, uses and can radiate radio frequency energy and, if not installed and used in accordance with the instructions, may cause harmful interference to radio communications. However, there is no guarantee that interference will not occur in a particular installation.

If this equipment does cause harmful interference to radio or television reception, which can be determined by turning the equipment off and on, the user is encouraged to try to correct the interference by one or more of the following measures:

- Reorient or relocate the receiving antenna.
- Increase the separation between the equipment and receiver.
- Connect the equipment into an outlet on a circuit different from that to which the receiver is connected.
- Consult the dealer or an experienced radio/TV technician for help.

FCC Radiation Exposure Statement

This equipment complies with FCC radiation exposure limits set forth for an uncontrolled environment.

This transmitter must not be co-located or operating in conjunction with any other antenna or transmitter.

IMPORTANT SAFETY INSTRUCTIONS

The appliance is intended for household.

 **DANGER** – To reduce the risk of electric shock:

Always unplug this appliance from the electrical outlet immediately after using and before cleaning.

 **WARNING** – To reduce the risk of burns, fire, electric shock, or injury to persons:

- 1) An appliance should never be left unattended when plugged in. Unplug from outlet when not in use, and before putting on or taking off parts.
- 2) Close supervision is necessary when this appliance is used by, on, or near children, invalids, or disabled persons.
- 3) Use this appliance only for its intended use as described in this manual. Do not use attachments not recommended by the manufacturer.
- 4) Never operate this appliance if it has a damaged cord or plug, if it is not working properly, if it has been dropped or damaged, or dropped into water. Return the appliance to a service center for examination and repair.
- 5) Do not carry this appliance by supply cord or use cord as a handle.
- 6) Keep the cord away from heated surfaces.
- 7) Never drop or insert any object into any opening.
- 8) Do not use outdoors.
- 9) Do not operate where aerosol (spray) products are being used or where oxygen is being administered.
- 10) To disconnect, turn all controls to the off position, then remove plug from outlet.

IMPORTANT SAFETY INSTRUCTIONS

Connect this appliance to a properly grounded outlet only. See Grounding Instructions.

This appliance is not intended for use by persons with reduced physical, sensory or mental capabilities, or lack of experience and knowledge, unless they have been given supervision or instruction concerning use of the appliance by a person responsible for their safety. Keep children under the age of 13 away from this machine.

To reduce the risk of electric shock, this appliance has a polarized plug (one blade is wider than the other). This plug will fit in a polarized outlet only one way. If the plug does not fit fully in the outlet, reverse the plug. If it still does not fit, contact a qualified electrician to install the proper outlet. Do not change the plug in any way.

Content

1. Products and Accessories	02
2. Structural Plan	03
3. Novice Guide	07
4. Learn How to Use the Treadmill	09
5. Warm-up Exercises	13
6. Safety Instructions	14
7. Maintenance	17
8. Declaration on the Harmful Substances	18
9. Trademark and Legal Declaration	19
10. Replacement and Disposal	20

Welcome to use

Thank you for selecting the 2 IN 1 TREADMILL, hereinafter referred to as the Treadmill. It has the ingenious, simple and innovative overall design, so that you can enjoy the quality life of healthy sports at home.

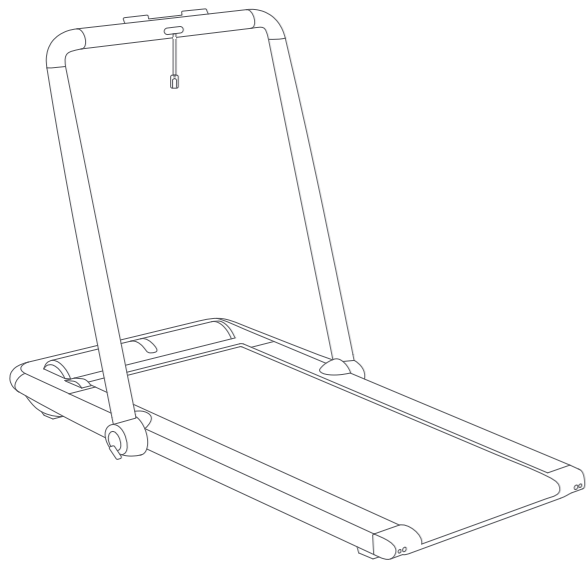

Specific Parameters	Detailed parameters
Working Dimension	1480×792×1060 mm
Folded Dimension	1530×792×139 mm
Walking Area	1210×480 mm
Gross Weight	39 kg
Net weight	33 kg
User Capacity	100 kg / 220 lbs
Applicable Age	14 ~ 60 years old
Applicable Height	Unlimited
Minimum Speed	0.8 km/h
Maximum Speed	12 km/h
Rated Power	700 W
Frequency	60 Hz
Voltage	120 V ~
Sport mode	Running Mode / Walking Mode

1. Products and Accessories

Please check carefully whether or not the treadmill is complete and intact. If there are any losses or damage, Please contact the seller.

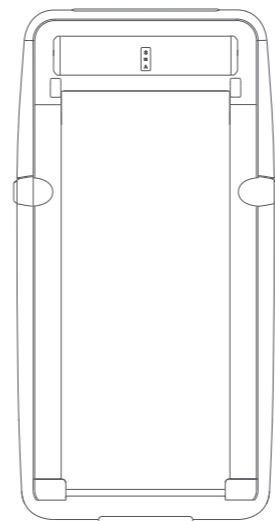

Main Product

Accessories



Power Cord



Safety Clip



Wrench



Silicone Oil



Remote Control



Bolt



User Manual

2. Structural Plan

1. Front Side

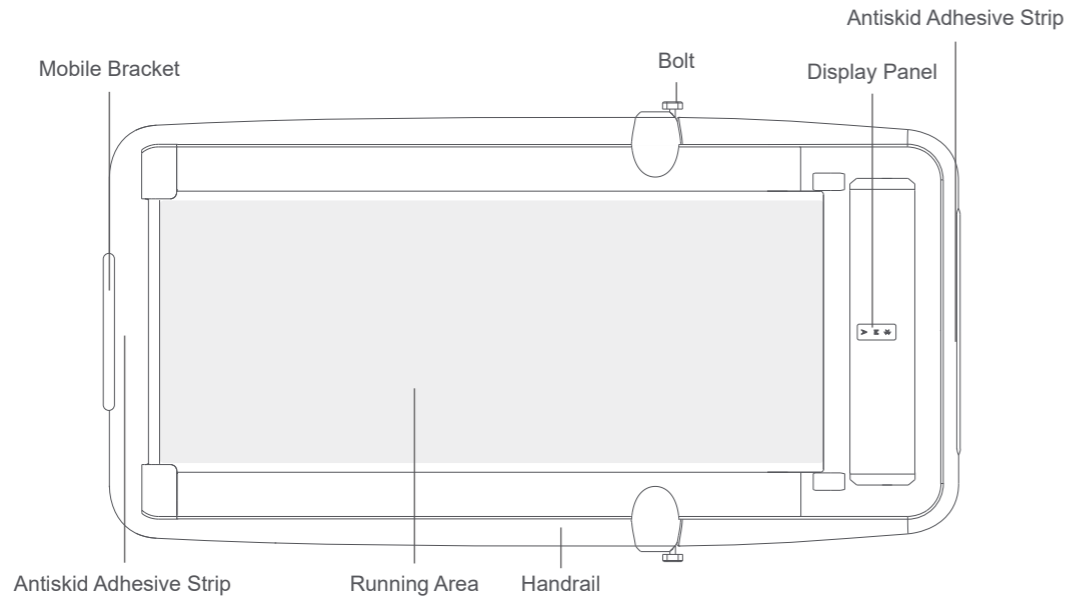

2. Back Side

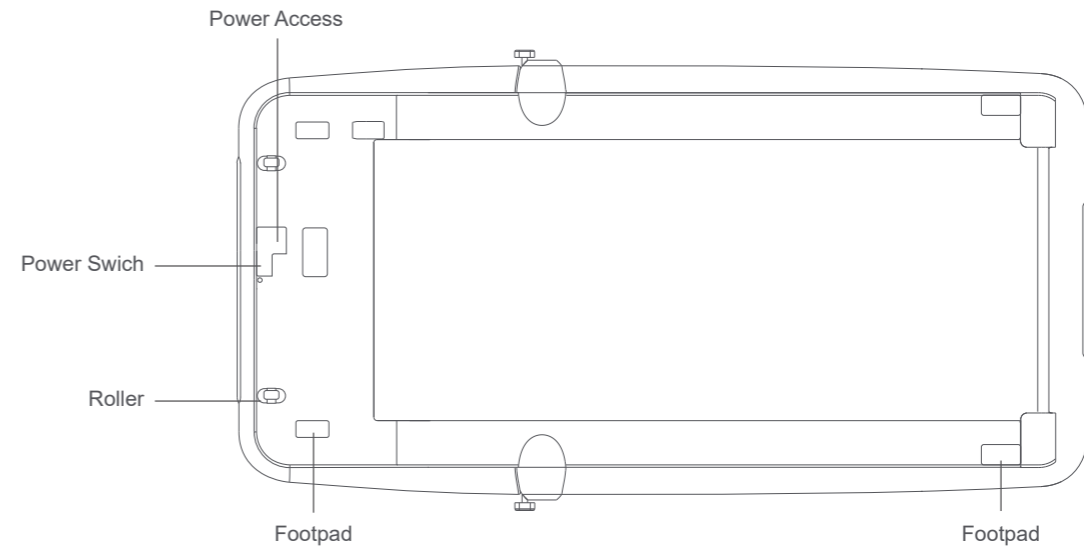

2. Structural Plan

3. Remote Control

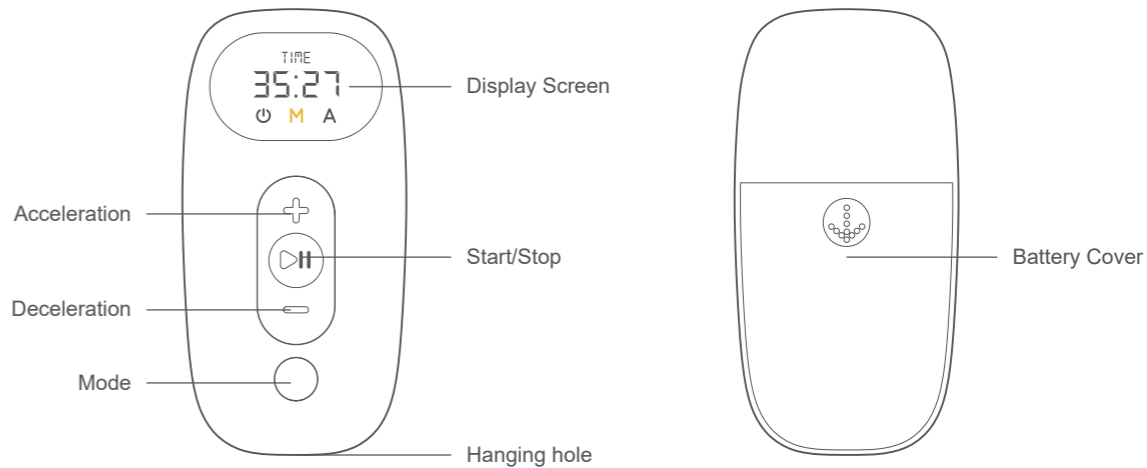
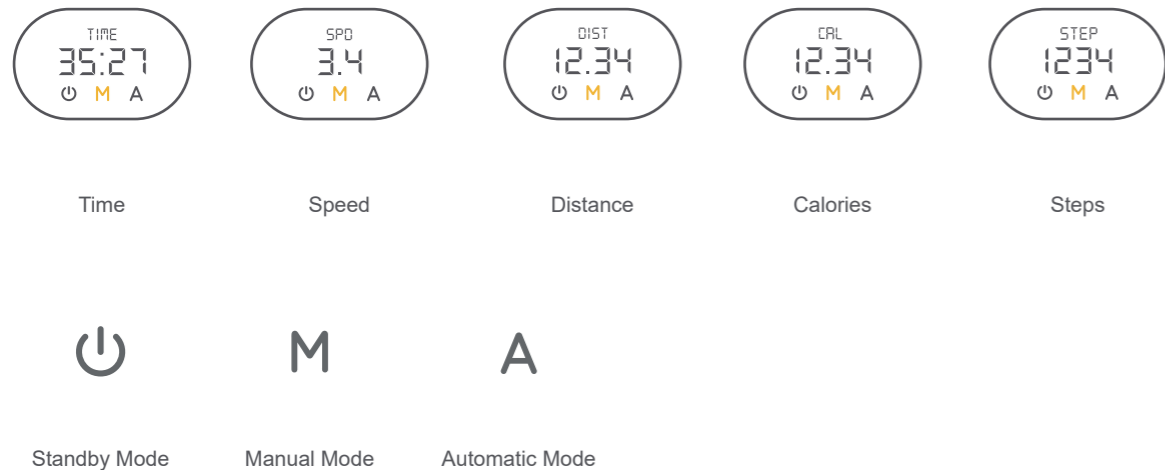

3. Novice Guide

Start to use this product for exercise according to your physical conditions, and do exercise properly and regularly so as to ensure you have sufficient physical strength. The wrong or excessive exercise will not be conducive to your health.

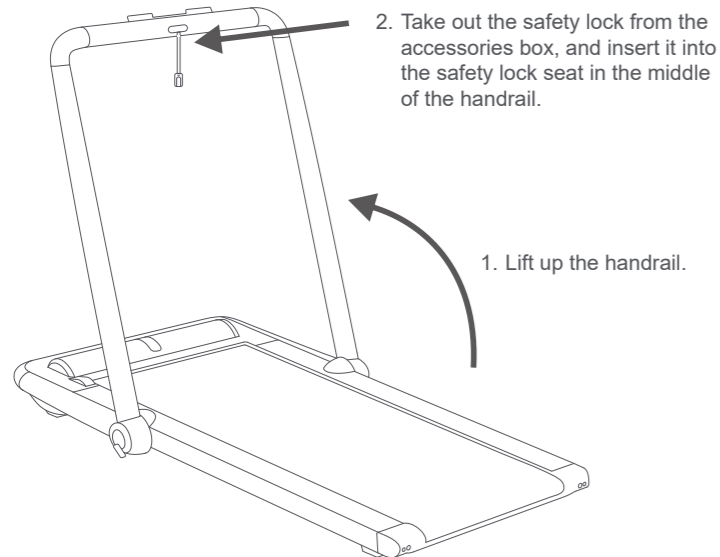

2. Take out the safety lock from the accessories box, and insert it into the safety lock seat in the middle of the handrail.

1. Lift up the handrail.

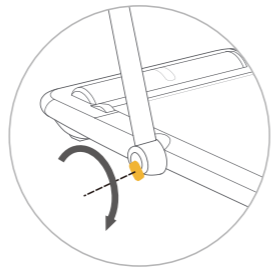

3. Take out the Bolts from the accessory box, insert it into the hole of handrail shaft, and rotate clockwise to lock the handrails on both sides.

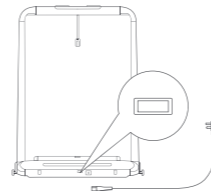

4. Connect the power cord, and turn on the switch.

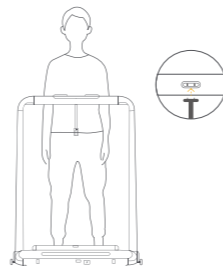

7. Insert safe key into the safety socket and clip the other end to your clothes.



5. Download APP "KS Fit" and complete the installation. If you would like to use the remote control directly, you can choose to skip the Step 5 and 6.



6. Open the APP and complete the registration. Connect the APP with the equipment step by step.

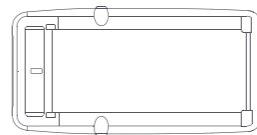

8. When pull down the handrail, user can start the treadmill without inserting in safety lock . Speed automatically will adjust to 0.8-6km/h, which is suitable for walking.



9. When lifting up the handrail, user can start the treadmill only after inserting in safety lock. Speed automatically adjusts to 0.8-12km/h, which is suitable for running.

4. Learn to Use the Treadmill

1. Mode Introduction

- ⏻** Standby Mode
When the light is on, electric motor and sensor stop functioning.
- M** Manual Mode
When the light is on, control the speed by the remote control or APP.
- A** Automatic Mode
Light of the automatic mode is on; Speed is controlled automatically by intelligent algorithm. It follows the speed of walking.

2. Standby Mode



Standby Mode

In this mode, the treadmill stops functioning to prevent the non-users from triggering the Treadmill.



Mode
Single Click: Return to the last mode.

3. Introduction to the control of the fixed speed mode (beginner mode)



Manual Control

Control the speed by using the remote control. We suggest beginner to walk under this mode firstly, only start walking under automatic mode after proficiently using the Treadmill.

In this mode, if the user leaves the Treadmill for more than 15 seconds, the Treadmill will stop automatically!

- Lift up the handrail, maximum speed is 12km/h, which is suitable for running. User can only use the machine after inserting safety key in the safety lock.
- Pull down the handrail, maximum speed is 6km/h, which is suitable for walking. User can use the treadmill without inserting safety key in the safety lock.
- If user stop using the treadmill more than 10 minutes, it will be in Standby Mode automatically.

When the machine stops, user can lock the machine by pressing & holding the mode button for more than 2 seconds.

To restart the treadmill, press and hold Start or Mode button for more than 2 seconds for unlocking.

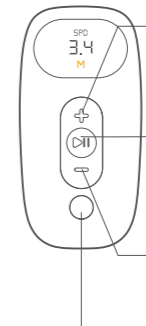

Acceleration
Single Click: accelerate by 0.5km/h;
Press and Hold: continuously accelerate.

Start/Stop
Single Click: Start or stop the Treadmill;
Press and Hold: For more than 2 seconds: unlock the treadmill.

Deceleration
Single Click: decelerate by 0.5km/h;
Press And Hold: continuously decelerate.

Mode key
Single Press: Switch to the automatic mode;
Press And Hold for more than 2 seconds: unlock the Treadmill.

4. Learn How to Use the Treadmill

4. Automatic Mode (advanced mode)

A

Automatic Mode

This mode is the advanced mode with higher difficulty. After starting, user can control the speed completely without the remote control. We only recommend those who have good sports skills or running experience to take the challenge.

Lifting up Handrail, Maximum speed is 9km/h, which is suitable for running

Pulling down the handrail, maximum speed is 6km/h, which is suitable for walking.

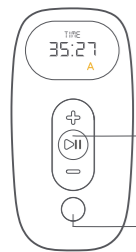

Start/Stop

Single Click: Start or stop the Treadmill;

Press and Hold: For more than 2 seconds: unlock the treadmill.

Mode key

Single Press: Switch to the automatic mode;

Press And Hold for more than 2 seconds: unlock the Treadmill.

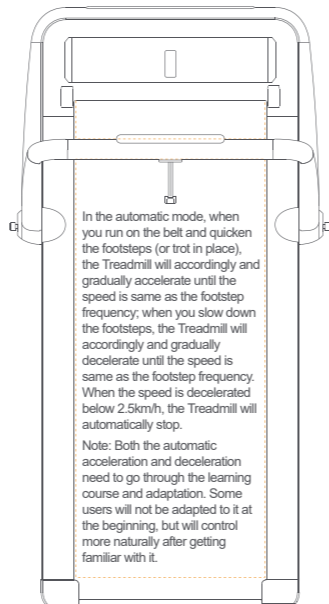

5. Remote Control Notice

If the remote control has no response or you change the remote control, you need to pair it again.

Pairing mode:

Restart the power, press and hold mode key on the remote control for 5 seconds, don't release until you hear the "click--" sound, which indicates pairing is successful.

6. Introduction to the status display

Manual Mode



Automatic Mode



KS symbol flashing: APP not connected.

KS symbol normally on: APP connected.

7. Error Warning Light

Error Warning Light on the display panel is off when "Walkingpad" works well. When error occurs, Error Warning Light turns on and shows its error code.

E01: Software overcurrent.

E07: Motor locked-rotor protection.

E02: Hardware overcurrent.

E08: Motor start failure.

E03: IPM module overheat.

E09: Motor overcurrent protection.

E04: Undervoltage protection.

E10: Overload protection.

E05: Overvoltage protection.

E11: HALL signal loss.

E06: Motor phase loss protection.

E12: Communication problem.

8. Networking and firmware upgrading

OTA firmware upgrading: in the "KS Fit APP" you may receive the updating prompt. Please view the updating introduction, and operate on your mobile phone according to the prompt to automatically complete the firmware upgrading.

5. Warm-up Exercises

The warm muscles can be stretched more easily and prevent the sports injury, so you can warm up for 5~10 minutes before having sports. We recommend you to do the stretching exercises according to the following methods, and repeat after completing the sports.

1. Stretch downward: Bend your knees slightly, bend your body forward slowly, relax your back and shoulder, your hands touch your toes as much as possible, keep this gesture for 10~15 seconds, then relax. Repeat this process for 3 times.
2. Stretch your hamstrings: Sit on the clean cushion, straighten one leg, and recover the other leg inward so as to make it cling to the inner side of the straightened leg. Your hands touch your toes as much as possible, keep this gesture for 10~15 seconds, then relax. Repeat this process on each leg for 3 times.
3. Stretch your calves and foot tendons: Stand with hands on the wall, put one foot backward, keep the hind leg upright and the heel on the ground, lean to the wall direction, keep this gesture for 10~15 seconds, then relax. Repeat this process on each leg for 3 times.
4. Stretch your quadriceps muscles: Put the left hand on the wall or table to balance yourself, extend your right hand backward, catch the right heel and pull it to your buttock slowly until you feel the front muscles of the thighs are tense, keep this gesture for 10~15 seconds, then relax. Repeat this process on each leg for 3 times.
5. Stretch your sartorius muscles (muscles at inner thighs): Sit down with the soles opposite one to the other and the knees being outward. Use your hands to catch the feet and pull to the groin direction, keep this gesture for 10~15 seconds, then relax. Repeat this process for 3 times.

*If there is any abnormal condition during the course of using the Treadmill, you may put your hands on the handrail and do pull-ups with feet leaving the Treadmill belt, then jump outside the Treadmill.

6. Safety Instructions

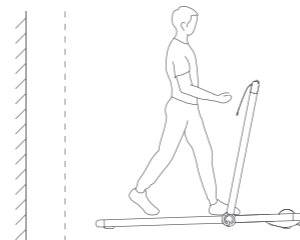

- ⚠ Keep the 2000mm×1000mm safety area between the Treadmill and the rear space.

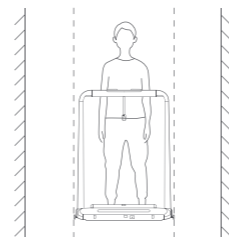

- ⚠ Keep the distance between the Treadmill and the space of both sides more than 500mm.

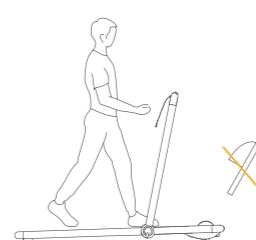

- ⚠ You must wear the sports shoes.

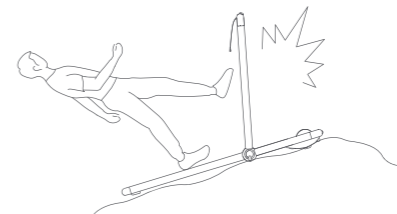

- ⊗ It is forbidden to put the Treadmill on the uneven ground.



- ⚠ When using it, please clip the clamp of the safety lock on your clothes (in case of unexpected conditions, you may pull off the safety lock and suspend the running of the electric motor immediately).



- ⚠ When the Treadmill is in idle status, please unplug the power cord to avoid the uncontrolled use by the third party.

6. Safety Instructions

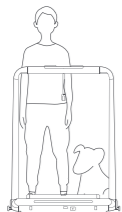

⊗ It is strictly forbidden to use the Treadmill with the pets.



⊗ It is strictly forbidden to walk backward.



⊗ It is strictly forbidden to walk sideways.

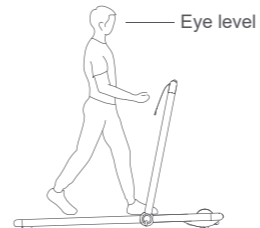

⚠ Keep the eyesight horizontal to avoid the visual dizziness.



⚠ The elderly and the pregnant should use the Treadmill discreetly.

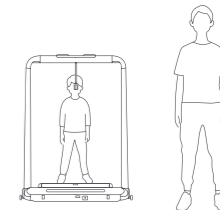

⚠ The juveniles should be accompanied and guided by the adult when using the Treadmill.

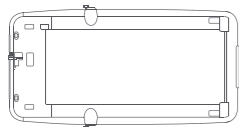

⊗ Prohibition of lateral placement.

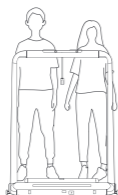

⊗ It is strictly forbidden to have more than one person use the Treadmill simultaneously.

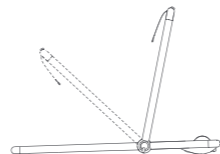

⊗ It is strictly forbidden to fold the Treadmill during the course of doing sports.

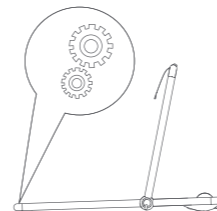

⚠ In order to prevent being caught in, please do not tread on the Treadmill.

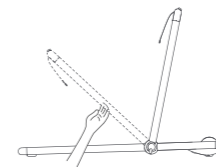

⊗ It is strictly forbidden to put the hands on both sides of the handrail when folding up so as to avoid hands pinching.

7. Maintenance

1. Cleaning



- Turn off the machine and unplug the power cord.
- Add several drops of detergent on cotton rag or towel. Don't pour the detergent on the belt directly, and don't use acid or corrosive cleaners.
- Wipe off dust and stains on the frame, front panel and belt. Do not wipe back-side of the belt.
- After using for a period, dust and stains may appear on the back part, that is normal situation, and just clean them up.

2. The Treadmill belt slipping and calibrating

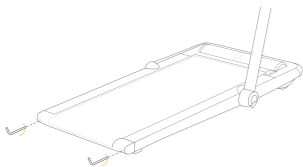

- If belt deviates from the right: rotate the left adjustment screw clockwise for 1/4 circle.
- If belt deviates from the left, rotate the right adjustment screw clockwise for 1/4 circle.
- The Treadmill belt slipping: simultaneously rotate the left and right adjustment screws together clockwise for half circle.
- Keep the machine running for 1-2 minutes and check whether it needs to readjust.

3. The Treadmill band lubricating

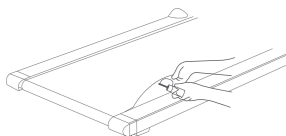

- Shut down and unplug the Treadmill power cord.
- Raise the Treadmill band edge and apply the silicone oil on the inner surface.
- Reconnect the Treadmill power.
- Let the Treadmill belt run for 10-20 seconds at the speed of 4km/h for use.
- One lubricating operation needs 5-10 ml silicone oil. Excessive applying will cause the slipping phenomenon and affect the normal use.
- Add the silicone oil once for every three months.

8. Declaration on the Harmful Substances

Component name	Harmful substances					
	Lead (Pb)	Mercury (Hg)	Cadmium (Cd)	Hexavalent Chromium (Cr(VI))	Polybrominated biphenyl (PBB)	Polybrominated diphenyl ether (PBDE)
Electronic devices	×	○	○	○	○	○
Metal parts	○	○	○	○	○	○
Casing	○	○	○	○	○	○
Battery	○	○	○	○	○	○
Other components	○	○	○	○	○	○

This table is prepared in accordance with the provisions of the SJ/T 11364.

○: indicating the content of this harmful substance in all the homogeneous materials of this component is below the limit requirements stipulated by the GB /T 26572.

×: indicating the content of this harmful substance in some homogeneous material of this component exceeds the limit requirements stipulated by the GB /T 26572.



9. Trademark and Legal Declaration

When printing, this Manual has contained various function introduction and use instructions as possible. However, because of continuous improvement of product functions, design changes, etc., there will still have some inconsistency with the product you purchased. Due to the product updating, this Manual will possibly have deviation with the actual product in aspects such as color, appearance, etc. The actual product shall prevail.

Product implementation standards:

GB17498.1-2008

GB17498.6-2008

10. Replacement and Disposal



The battery contained in this appliance must be removed for or disposal.

When replacing the battery, use only original battery, available from our online parts shop.

The battery compartment is located on the underside of the appliance. Open the compartment by removing the screw in the cover using a suitable screwdriver, and then press the lower end of the locking catch on the connectors. In that way, both sides of the connection can be separated by pulling them apart.

When inserting a new battery, push together the two connectors and ensure that the catch locks over the stop.

Never dispose of old battery in domestic garbage, but only through the proper public collection points. This also applies to the battery of defective appliances.

10. Replacement and Disposal



Devices marked with this symbol must be disposed of separately from your household waste, as they contain valuable materials which can be recycled. Proper disposal protects the environment and human health. Your local authority or retailer can provide information on the matter.