

US

Model.URTM028

SPACEWALK E3

Walking Treadmill With Manual Incline

USER MANUAL

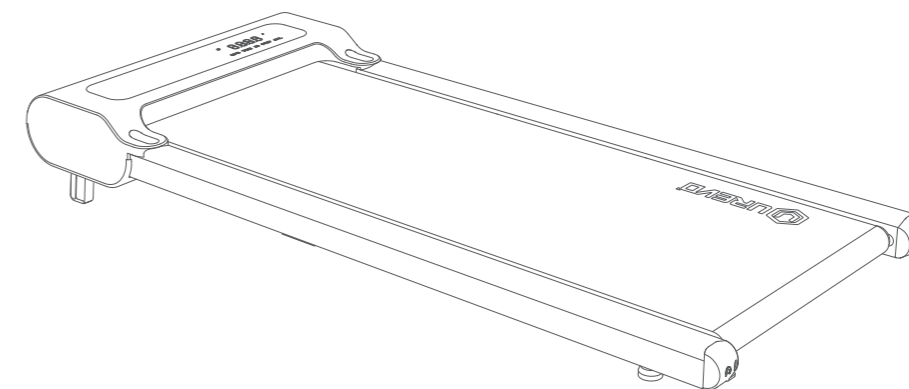

IMPORTANT: Read all instructions carefully before using this product. Retain this owner's manual for future reference. The specifications of this product may vary from this photo, subject to change without notice.

Manufacturer: Shenzhen Yile Dynamic Technology Co., LTD.

Address: 1205-1206, Tianliao Building, Tangchang Road, Tanglang Community, Taoyuan Street, Nanshan District, Shenzhen, China

Version: 1.0



MADE IN CHINA





TABLE OF CONTENTS

02 CUSTOMER SERVICE

03 IMPORTANT SAFETY INSTRUCTIONS

06 SAFETY NOTICE

09 SPECIFICATION

10 PRODUCT AND ACCESSORIES

11 PRODUCT INTRODUCTION

12 BEFORE START AND STORAGE

14 FUNCTION MENU

15 REMOTE CONTROL

16 HOW TO USE

20 CARE AND MAINTENANCE

22 WARRANTY



1 CUSTOMER SERVICE

IMPORTANT: FOR UREVO ONLY

For damaged or defective product, questions, replacement parts or any other service support, please contact our customer service department by the below methods:

services@urevosports.com

Response Time: 24-48 hours

Emailing us with the **Order ID** will be the best method to receive a response during peak business hours.

Website: www.urevosports.com

US Support Hotline: (1)844-998-2473

Hours of Operation:

Monday – Friday : 9 AM – 12 PM; 1 PM – 6 PM (PST)

PLEASE DO NOT RETURN THIS PRODUCT WITHOUT ASKING OUR CUSTOMER SERVICE FIRST.

02

SCAN THIS QR CODE TO GET THE PRODUCT INSTALLATION OR MAINTENANCE VIDEOS



2 IMPORTANT SAFETY INSTRUCTIONS

DANGER - To reduce the risk of electric shock:

Always unplug this appliance from the electrical outlet immediately after using and before cleaning.

WARNING - To reduce the risk of burns, fire, electric shock, or injury to persons:

1. An appliance should never be left unattended plugged in. Unplug from outlet when not in use, and before putting on or taking off parts.
2. Do not operate under blanket or pillow. Excessive heating can occur and cause fire, electric shock, or injury to persons.
3. Close supervision is necessary when this appliance is used by, on, or near children, invalids, or disabled persons.
4. Use this appliance only for its intended use as described in this manual. Do not use attachments not recommended by the manufacturer.
5. Never operate this appliance if it has a damaged cord or plug, if it is not working properly, if it has been dropped or damaged, or dropped into water. Return the appliance to a service center for examination and repair.

6. Do not carry this appliance by supply cord or use cord as a handle.
7. Keep the cord away from heated surfaces.
8. Never operate the appliance with the air openings blocked. Keep the air openings free of lint, hair, and the like.
9. Never drop or insert any object into any opening.
10. Do not use outdoors.
11. Do not operate where aerosol (spray) products are being used or where oxygen is being administered.
12. Caution - To reduce the risk of injury from moving parts - Unplug before servicing.
13. Warning - To reduce the risk of Electric shock - Unplug before cleaning or servicing.
14. Warning - Risk of personal injury - Keep children under the age of 13 away from walking treadmill.
15. To disconnect, turn all controls to the position, then remove plug from outlet.
16. Connect this appliance to a properly outlet only. See grounding instructions.
17. This appliance is not intended for use by

03

persons with reduced physical, sensory or mental capabilities, or lack of experience and knowledge, unless they have been given supervision or instruction concerning use of the appliance by a person responsible for their safety. Keep children under the age of 13 away from this walking treadmill.

18. The maximum weight capacity for this product is 264.5lbs/120kg. DO NOT EXCEED MAXIMUM WEIGHT CAPACITY.

SAVE THESE INSTRUCTIONS

GROUNDING INSTRUCTIONS:

This product must be grounded. If it should malfunction or breakdown, grounding provides a path of least resistance for electric current to reduce the risk of electric shock and a grounding plug. The plug must be plugged into an appropriate outlet that is properly installed and grounded in accordance with all local codes and ordinances.

DANGER - Improper connection of the equipment-grounding conductor can result in a risk of electric shock. Check with a qualified electrician or serviceman if you are in doubt as to whether the product is properly grounded. Do not modify the plug provided with the product - if it will not fit the outlet, have a proper outlet installed by a qualified electrician.

04

FCC STATEMENT :

Operation is subject to the following two conditions:

- (1) This device may not cause harmful interference, and
 - (2) This device must accept any interference received, including interference that may cause undesired operation.
- (3) Any Changes or modifications not expressly approved by the party responsible for compliance could void the user's authority to operate the equipment.

Note: This equipment has been tested and found to comply with the limits for a Class B digital device, pursuant to part 15 of the FCC Rules. These limits are designed to provide reasonable protection against harmful interference in a residential installation. This equipment generates, uses and can radiate radio frequency energy and, if not installed and used in accordance with the instructions, may cause harmful interference to radio communications. However, there is no guarantee that interference will not occur in a particular installation. If this equipment does cause harmful interference to radio or television reception, which can be determined by turning the equipment off and on, the user is encouraged to try to correct the interference by one or more of the following measures:

- Reorient or relocate the receiving antenna.
- Increase the separation between the equipment and receiver.
- Connect the equipment into an outlet on a circuit

different from that to which the receiver is connected.

- Consult the dealer or an experienced radio/TV technician for help.

This device complies with RSS210 of Industry Canada. Cet appareil se conforme à RSS210 de Canada d'Industrie. This device complies with Industry Canada license-exempt RSS standard(s). Operation is subject to the following two conditions: (1) this device may not cause interference, and (2) this device must accept any interference, including interference that may cause undesired operation of the device. appareils radio exempts de licence. Son fonctionnement est sujet aux deux conditions suivantes: (1) le dispositif ne doit pas produire de brouillage préjudiciable, et (2) le dispositif doit accepter tout brouillage reçu, y compris un brouillage susceptible de provoquer un fonctionnement indésirable.

Radiation Exposure Statement: The product complies with the Canada portable RF exposure limit set forth for an uncontrolled environment and are safe for intended operation as described in this manual.

The further RF exposure reduction can be achieved if the product can be kept as far as possible from the user body or set the device to lower output power if such function is available.

Déclaration d'exposition aux radiations : Le produit est conforme aux limites d'exposition pour les

appareils portables RF pour les Etats-Unis et le Canada établies pour un environnement non contrôlé.

Le produit est sûr pour un fonctionnement tel qu'il est décrit dans ce manuel. La réduction aux expositions RF peut être augmentée si l'appareil peut être conservé aussi loin que possible du corps de l'utilisateur ou que le dispositif est réglé sur la puissance de sortie la plus faible et que la fonction est disponible.

This Class B digital apparatus complies with Canadian ICES-003.

Cet appareil numérique de la classe B est conforme à la norme NMB-003 du Canada.

05

3 / SAFETY NOTICE



⚠ With at least 3.28 ft.(1.0 m) of clearance behind.

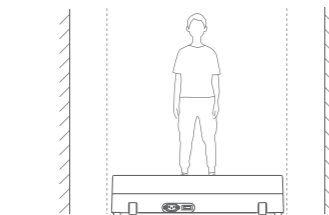

⚠ With at least 2 ft.(0.6 m) clearance on each side.



⚠ Always wear athletic shoes.

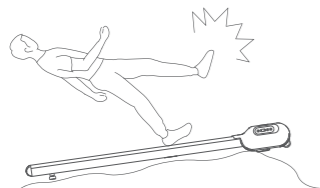

⊗ Do not use on uneven ground.

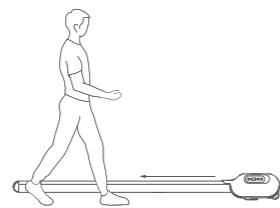

⊗ It is strictly forbidden to walk up and down the walking treadmill while walking.

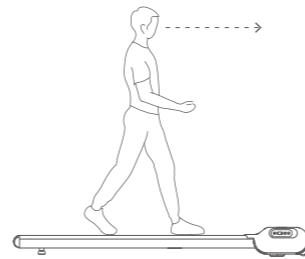

⚠ Please keep your sight horizontal to avoid dizziness.

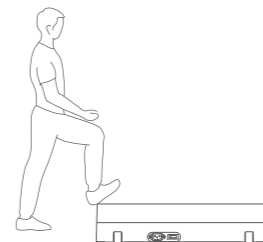

⊗ Trampling the treadmill lid is prohibited.

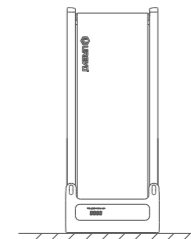

⊗ Do not storage as stand up.

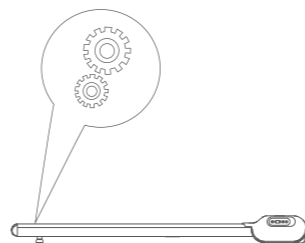

⚠ Keep feet, hands, and fingers away from moving parts.

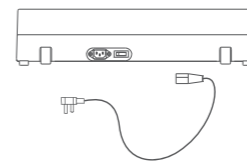

⚠ Unplug from outlet when not in use.

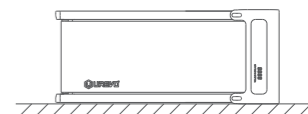

⊗ Do not storage as side stand.

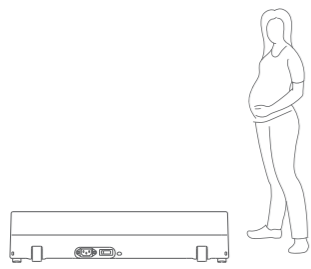

⊗ Be carefully of elderly and pregnant woman use .

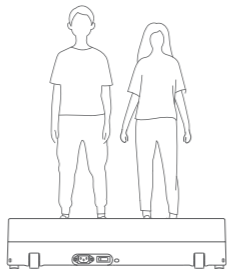

⊗ Never allow more than one person on the treadmill at a time .

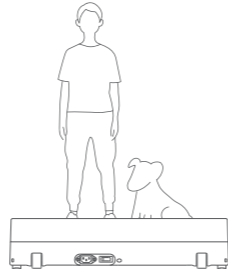

⊗ Do not walking with pets.

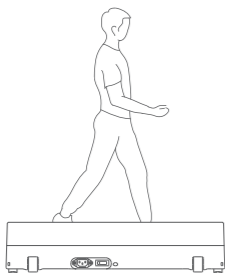

⊗ Do not transverse motion.

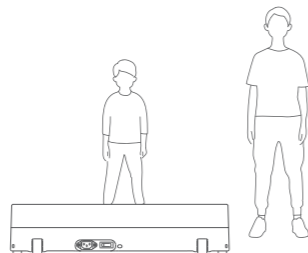

⚠ Children use MUST be under supervised.

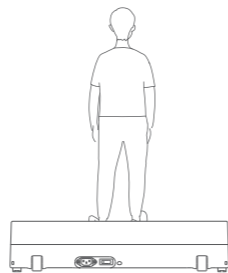

⊗ Do not backward motion.

4 / SPECIFICATION

Performance indicators	Detailed parameters	Performance indicators	Detailed parameters
Product dimension	126.5 X 53 X 12.4 cm	Net weight	25 kg
	49.8 X 20.87 X 4.88 inch		55.11 lbs
Walking Area	102.4 X 40 cm	Gross weight	28.5 kg
	40.32 X 15.75 inch		62.84 lbs
Maximum load	120 kg	Rate voltage	110 - 120V ~
	264.5 lbs	Rated power	550W (Walking treadmill)
Maximum speed	4 mph	Peak horsepower	2.25Hp
Minimum speed	0.6 mph	Suggested age	14-60 years old
Manual incline percentage	3%	/	/

5/PRODUCT AND ACCESSORIES

Please carefully check whether the contents of the package are complete and intact.
If there is any missing and damage, please contact the seller.

Accessories

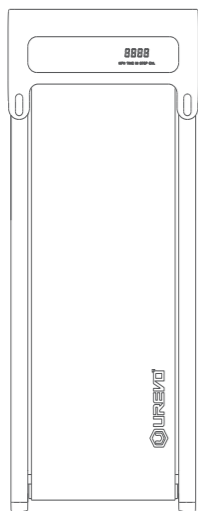

Walking treadmill × 1



Remote Controller x 1

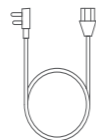

Power Cord x 1



Lubricating Oil x 2



Hex Tool × 1



User Manual x 1

6/PRODUCT INTRODUCTION

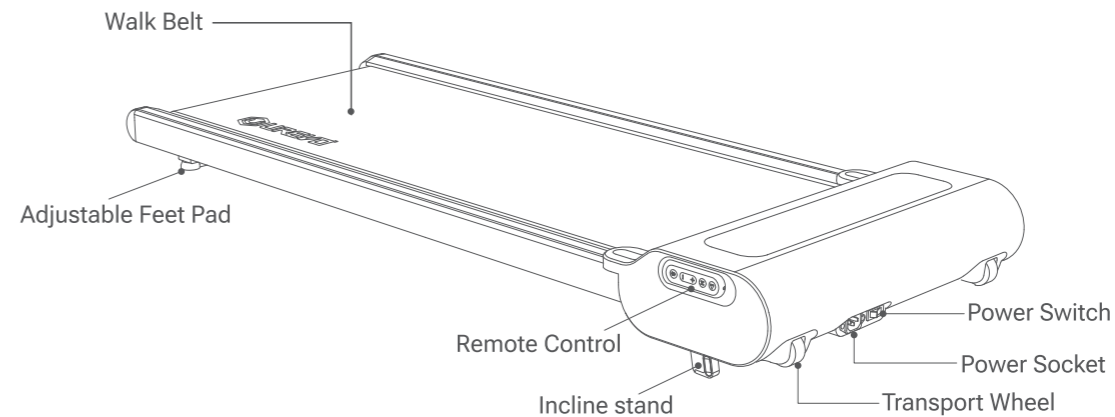

7 / BEFORE START AND STORAGE

- Take out appliance from packages.

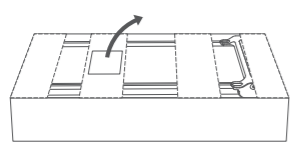

3. Unbox and take out accessory box.

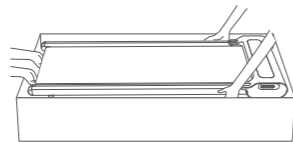

2. Lift out appliance and place at flat surface.
Attention: 2-3 persons assist is necessary.

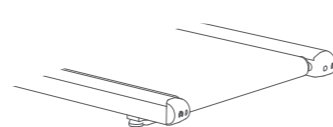

3. Its normal that visible welding marks residual on walk belt.

- Transportation

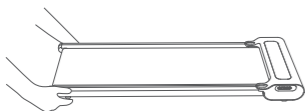

1. If transportation needs, unplug power cord and lifting the terminal of appliance.
12

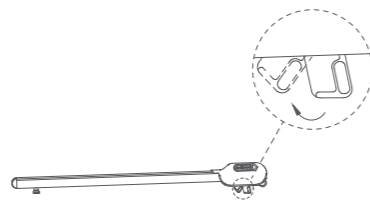

2. Make sure incline stands are folded .

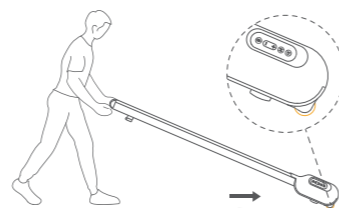

3. Easy to transport appliance with bottom transportation wheel assists, like as wheelbarrow.

- Connect the power

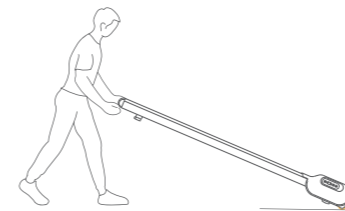

1. Choose flat ground to place the Walking Treadmill. Do not place it on thick and soft

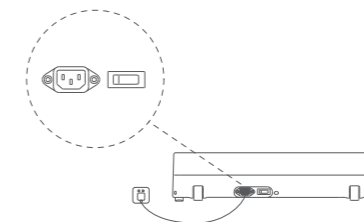

cushion.
2. Plug in power cord and switch on power rock button, you can hear a Bi sound from buzzer, its means the circuit of appliance has connected with power electricity.
Warning: MUST use power cord with comes of package.

- Storage

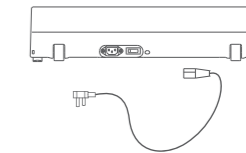

Power off appliance and unplug power cord before storage process.

Warning:
Before starting to workout with this product, Please assess your physical condition and perform exercise properly and regularly. Incorrect or excessive training can be harmful to your health, If you feel unwell, Stop exercising immediately and consult with your doctor.

8 / FUNTION MENU

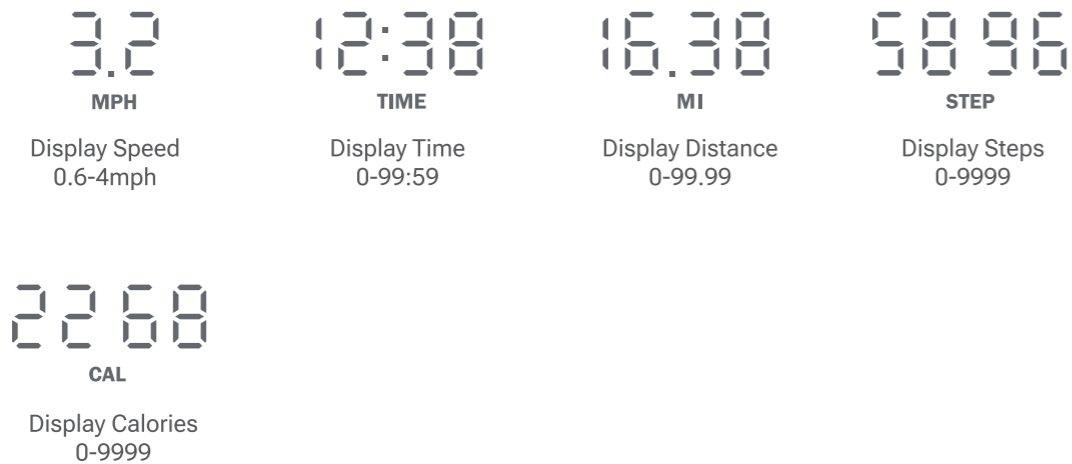

Tips: The workout datas (Calorie; Time; Step; Distance; Speed) will be circularly displayed per 5s.

9 / REMOTE CONTROL

A magnet built in remote control so that it can be stuck in storage cavity of side body as shown in figure.

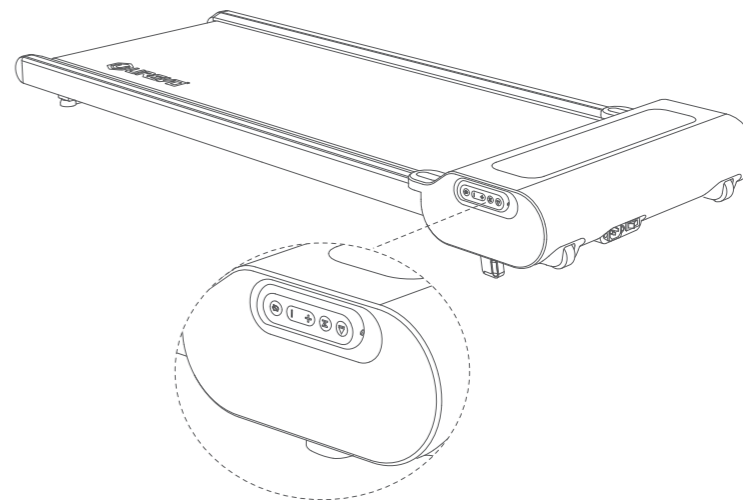
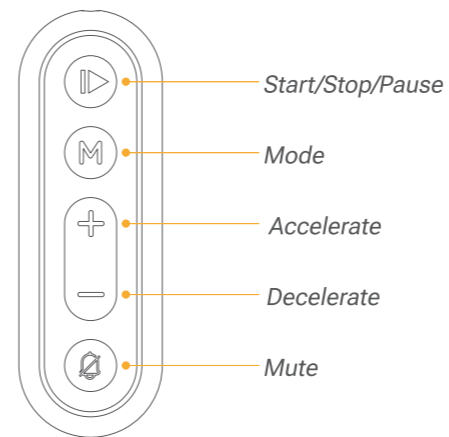

10/HOW TO USE

Note: Ensure that the walking treadmill is power on and the remote control is installed with batteries.

1. Operation of Remote Controller

Buttons	Functions	Operation	Note
▶	Start	Short press	Start the walking treadmill
	Stop	Long press for 2"	When the walking treadmill stop (all datas recover to 0), the screen will display "END". 10 minutes later, the system will switch to the economic mode and turn off the display screen; Press any buttons to wake up the treadmill.
	Pause	Short press (in start mode)	The screen will display "PAU", previous workout metrics will be preserved automatically if pause time no longer than 10minutes, otherwise metrics data will be recovered to "0"; Press any buttons to wake up the treadmill. The treadmill will re-start at the minimum speed by re-pressing ▶.
M	M Mode	Short press	Customize countdown workout programs (like as: Time; Distance; Steps; Calories)
+	Accelerate	Short press	Long press over 0.5 seconds, the speed will be increased continuously.
-	Decelerate	Short press	Long press over 0.5 seconds, the speed will be decreased continuously.
🔇	Mute	Short press	short press: Muted buzzer voices

2. Instructions for Incline stand use

The unique foldable incline options that provides users of ability to increasing the intensity of exercise, you saw commensurate increases in fitness.

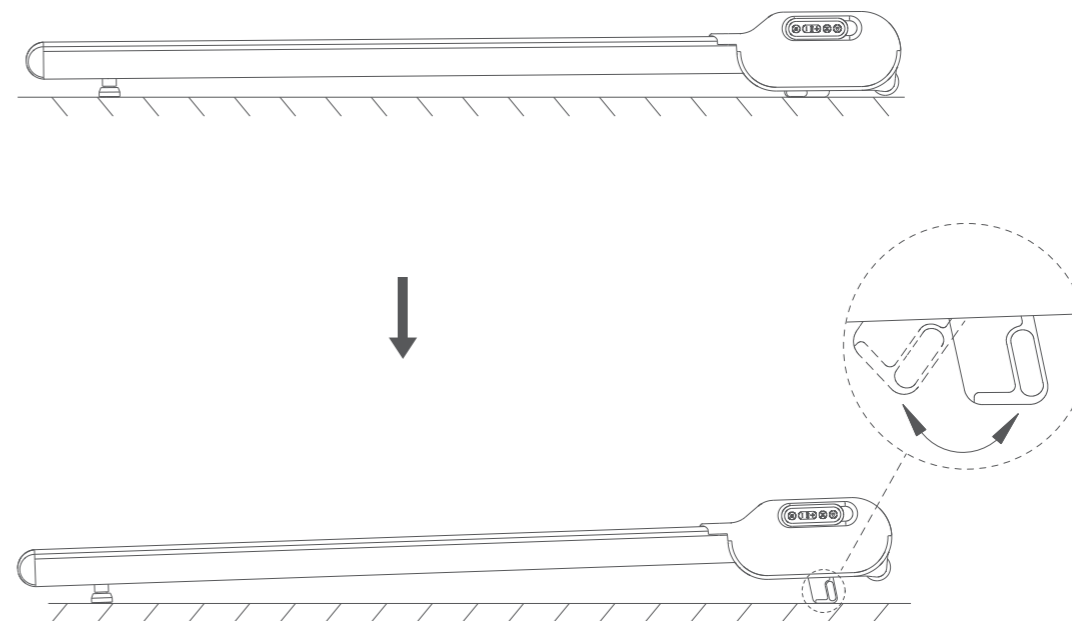

3. Error Code

When error occurs, error warning indicator will light up and display its error code.

Error Code	Fault Analysis	Resolutions
E02	Mosfet breakdown	Please contact with after sale service.
E05	Flame protection	Unscrew motor hood and verify connection between controller and motor, otherwise please contact with after sale service.
E06	Motor open circuit	Unscrew motor hood and verify the motor terminals connection . Otherwise please contact with after sale service.
E07	Communcation interrupted	Unscrew motor hood to verify signal cable whether was pinched or terminal loosen.
E08	Overloading protection	1. User weight over limited 120KG. 2. Removal foreign bodies which causes of roller or walking belt. 3. Inject lubricants.

Not only error code appeared but also built in buzzer alarm, Once error code and alarm happened, you MUST stop workout immediately, Please contact with after sale service if problem CAN NOT be solved after restart.

4. Troubleshooting

Problem	Fault Analysis	Resolutions
No working	1. Power rock switch dyfunction 2. Power supply interrputed. 3. Power cord damaged	1. Replace new power rock switch if it doesn't light on. 2. Make sure that power cord is plugged into properly grounded outlet. 3. Replace new power cable.
Walking belt slips	Walking belt loosen	Tighten walking belt tension with hex tool. (See details of chapter 11-A)
Remote control does not work	1. Incorrect use of default 2. Battery power shortage. 3. Remote control maulfunction	1. Replace new battery cells. 2. Replace new remote control.
Friction noise	Walking belt off center.	See details of chapter 11-A.

11 / CARE AND MAINTENANCE

A. Symptom : walk belt off centered or slips.

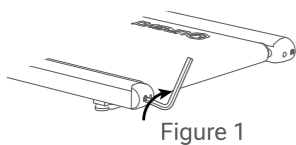

Figure 1

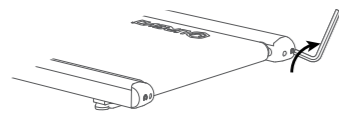

Figure 2

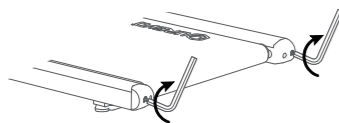

Figure 3

Centering walk belt process as follow :

1. Power off appliance and unplug the power cord .
2. Manual centering process as follow:
 - If the walk belt has shifted to left, use the hex tool to turn the left idler roller screw clockwise **1/4** of a turn(refer to figure 1).
 - If the walk belt has shifted to right, use the hex tool to turn the right idler roller screw clockwise **1/4** of turn(refer to figure 2).
3. Appliance MUST work 1-2minutes. Repeat manual centering process untill the walk belt is centered.

Belt slip correcting process as follow :

1. Power off appliance before operation.
2. Using the hex tool, turn both idler roller screws clockwise **1/2** of turn (refer to figure 3).
3. After corrected, please attempts to walking 1-2 minutes under 1.0mph speed setting. Repeat until the walk belt is properly tightened.

Attentions

1. To prevent any injury, don't place any debris around appliance before maintenance process.
2. MUST use associated hex tool.
3. Take care at maintenance process. Do not pinch fingers.

B. Belt lubrication process, follow instruction below to lubricate belt.

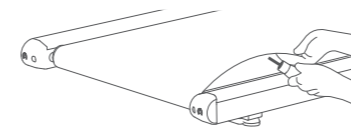

1. Power off appliance and unplug cord.
2. Using the hex tool, turn both idler roller screws counterclockwise till belt loosen and lifting easily.
Tips: please markdown hex tool rotating cycles when loosen belt, which use for adapting belt tension after lubrication process.
3. Lifting edges of belt and spraying lubrication oil at center of walk platform evenly. Not necessary to apply spray lubrication oil on entire walk platform.
4. Lubrication oil volume Per time of maintenance: 5-10mL.
Attention: it would causes of belt slip if spray too much.
5. Using the hex tool, turn the both idler screws clockwise as previous markdown number of turns untill walk belt tighten properly.
6. Power on appliance and workout for a few minutes, in order to spread lubrication oil to whole belt surface evenly.
Lubrication frequency: High recommend 125 Miles Per time.

C : Appliance cleaning.

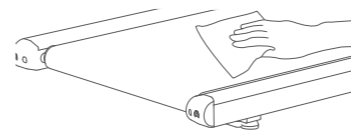

1. Power off appliance and unplug power cord before cleaning.
2. Wipe and clean with damp cloth, Do not cleaning with acidic or caustic detergents.
3. Do not clean opposite of walk belt.
4. Its normal few black powders residual under appliance after long working.

12/WARRANTY

MANUFACTURER'S LIMITED WARRANTY

UREVO warrants to the original purchaser that this product is free from defects in material and workmanship when used for the purpose intended, under the conditions that it has been installed and operated in accordance with UREVO Owner's Manual. UREVO's obligation under this warranty applies to the following:

COMPONENT LENGTH OF WARRANTY

Structural Frame 1 year For Home Use Only
All Other Components 90 days For Home Use Only

Exclusions from Warranty Coverage:

UREVO does not warrant against and is not responsible for, and no implied warranty shall be deemed to cover, any product failure, product malfunction, or damages attributable to:

1. Improper installation and/or failure to abide by UREVO's installation guidelines;
2. Use of this product beyond normal home use, or in an application for which it was not designed;
3. Cosmetic items such as scratches, dents or discolorations;
4. Damage caused by normal wear and tear, vandalism,

- accidental or by animals;
5. Any act of Nature (such as fire, flooding, snow, ice, hurricanes, earthquakes, lightnings or other natural disasters), environmental condition (such as air pollution, mold, mildew, etc.), or staining from foreign substances (such as dirt, grease, oil, etc.);
6. Normal weathering due to exposure to sunlight, weather and atmosphere which can cause colored surfaces to among other things, flake, chalk, accumulate dirt or stains.
7. Improper operation, alteration, handling, storage, abuse or neglect of the products.

UREVO , using its sole discretion, will either repair or replace free of charge any part(s) proven to be defective under normal home use. Any repair or replacement shall provide no new warranty coverage, but shall retain only the remaining portion of the original product's warranty. This warranty is offered only to the original purchaser and is not transferable. Proof of original purchase is required.

When ordering replacement parts please have the following information ready:

1. Order Number
2. Description of Parts
(Adding photos or videos would be helpful)
3. Part Number
4. Date of Purchase



FCC Statement

This equipment has been tested and found to comply with the limits for a Class B digital device, pursuant to part 15 of the FCC Rules. These limits are designed to provide reasonable protection against harmful interference in a residential installation. This equipment generates, uses and can radiate radio frequency energy and, if not installed and used in accordance with the instructions, may cause harmful interference to radio communications. However, there is no guarantee that interference will not occur in a particular installation. If this equipment does cause harmful interference to radio or television reception, which can be determined by turning the equipment off and on, the user is encouraged to try to correct the interference by one or more of the following measures:

- Reorient or relocate the receiving antenna.
- Increase the separation between the equipment and receiver.
- Connect the equipment into an outlet on a circuit different from that to which the receiver is connected.
- Consult the dealer or an experienced radio/TV technician for help.

Caution: Any changes or modifications to this device not explicitly approved by manufacturer could void your authority to operate this equipment.

This device complies with part 15 of the FCC Rules. Operation is subject to the following two conditions: (1) This device may not cause harmful interference, and (2) this device must accept any interference received, including interference that may cause undesired operation.

RF Exposure Information

The device has been evaluated to meet general RF exposure requirement. This equipment should be installed and operated with minimum distance 0mm between the radiator & your body.

ISED Statement

English: This device contains licence-exempt transmitter(s)/receiver(s) that comply with Innovation, Science and Economic Development Canada's licence-exempt RSS(s). Operation is subject to the following two conditions:

- (1) This device may not cause interference.
- (2) This device must accept any interference, including interference that may cause undesired operation of the device.

The digital apparatus complies with Canadian CAN ICES-3 (B)/NMB-3(B).

French: Cet appareil contient des émetteurs/récepteurs exempts de licence qui sont conformes aux RSS exemptés de licence d'Innovation, Sciences et Développement économique Canada.

L'exploitation est soumise aux deux conditions suivantes :

- (1) Cet appareil ne doit pas provoquer d'interférences.
- (2) Cet appareil doit accepter toute interférence, y compris les interférences susceptibles de provoquer un fonctionnement indésirable de l'appareil.

l'appareil numérique du ciem conforme canadien peut - 3 (b) / nmb - 3 (b).

This device meets the exemption from the routine evaluation limits in section 2.5 of RSS 102 and compliance with RSS 102 RF exposure, users can obtain Canadian information on RF exposure and compliance.

cet appareil est conforme à l'exemption des limites d'évaluation courante dans la section 2.5 du cnr - 102 et conformité avec rss 102 de l'exposition aux rf, les utilisateurs peuvent obtenir des données canadiennes sur l'exposition aux champs rf et la conformité.

This equipment complies with Canada radiation exposure limits set forth for an uncontrolled environment.

Cet équipement est conforme aux limites d'exposition aux rayonnements du Canada établies pour un environnement non contrôlé.

RF Exposure Statement

The device has been evaluated to meet general RF exposure requirement. This equipment should be installed and operated with minimum distance 0mm between the radiator & your body.

L'appareil a été évalué pour répondre aux exigences générales d'exposition aux RF. Cet équipement doit être installé et utilisé avec une distance minimale de 0 mm entre le radiateur et votre corps.