

# Foshan Samyoo Electronic Co.,Ltd

## TEST REPORT

**SCOPE OF WORK**

EMC TESTING–KF-P20W, KF-P21W, KF-P22W

**REPORT NUMBER**

220421038GZU-001

**ISSUE DATE**

20-January-2023

**[REVISED DATE]**

[-----]

**PAGES**

62

**DOCUMENT CONTROL NUMBER**

FCC WIFI-c

© 2017 INTERTEK



## TEST REPORT

Applicant Name & Address : Foshan Samyoo Electronic Co., Ltd  
No.2, 6th East Road Jiangcun Industrial Zone, Leliu, Shunde, Foshan,  
Guangdong, China  
Manufacturing Site : Same as applicant  
Intertek Report No: 220421038GZU-001  
FCC ID: 2ARBZ-KFPXXXW

## Test standards

**47 CFR PART 15 Subpart C: 2021 section 15.247**

## Sample Description

Product : AIR PURIFIER  
Model No. : KF-P20W, KF-P21W, KF-P22W  
Electrical Rating : 120~240V 50/60Hz  
Serial No. : Not Labeled  
Date Received : 21 April 2022  
Date Test : 16 November 2022 to 30 November 2022  
Conducted

Prepared and Checked By



Elena Lei  
Engineer

Approved By:



Dean Liu  
project Engineer

This report is for the exclusive use of Intertek's Client and is provided pursuant to the agreement between Intertek and its Client. Intertek's responsibility and liability are limited to the terms and conditions of the agreement. Intertek assumes no liability to any party, other than to the Client in accordance with the agreement, for any loss, expense or damage occasioned by the use of this report. Only the Client is authorized to permit copying or distribution of this report and then only in its entirety. Any use of the Intertek name or one of its marks for the sale or advertisement of the tested material, product or service must first be approved in writing by Intertek. The observations and test results in this report are relevant only to the sample tested. This report by itself does not imply that the material, product, or service is or has ever been under an Intertek certification program.

**TEST REPORT**

**CONTENT**

**TEST REPORT ..... 1**

**CONTENT ..... 3**

**1.0 TEST RESULT SUMMARY ..... 4**

**2.0 GENERAL DESCRIPTION..... 5**

    2.1 PRODUCT DESCRIPTION ..... 5

    2.2 RELATED SUBMITTAL(S) GRANTS ..... 5

    2.3 TEST METHODOLOGY ..... 6

    2.4 TEST FACILITY..... 6

**3.0 SYSTEM TEST CONFIGURATION ..... 6**

    3.1 JUSTIFICATION ..... 6

    3.2 EUT EXERCISING SOFTWARE..... 7

    3.3 SPECIAL ACCESSORIES ..... 7

    3.4 MEASUREMENT UNCERTAINTY ..... 8

    3.5 EQUIPMENT MODIFICATION ..... 8

    3.6 SUPPORT EQUIPMENT LIST AND DESCRIPTION ..... 9

**4.0 MEASUREMENT RESULTS..... 10**

    4.1 ANTENNA REQUIREMENT ..... 10

    4.2 6 DB BANDWIDTH (DTS BANDWIDTH) ..... 11

    4.3 DUTY CYCLE..... 18

    4.4 MAXIMUM AVERAGE CONDUCTED OUTPUT POWER..... 21

    4.5 PEAK POWER SPECTRAL DENSITY..... 23

    4.6 OUT OF BAND CONDUCTED EMISSIONS ..... 30

    4.7 OUT OF BAND RADIATED EMISSIONS..... 37

    4.8 RADIATED EMISSIONS IN RESTRICTED BANDS..... 37

    4.9 BAND EDGES REQUIREMENT ..... 54

    4.10 CONDUCTED EMISSION TEST..... 59

**5.0 TEST EQUIPMENT LIST ..... 62**

## TEST REPORT

### 1.0 TEST RESULT SUMMARY

| Test Item  | Test Requirement                                    | Test Method   | Result |
|--|---|---|--------|
| Antenna Requirement  | FCC PART 15 C section 15.247 (c) and Section 15.203 | FCC PART 15 C section 15.247 (c) and Section 15.203 | PASS   |
| 6 dB Bandwidth (DTS bandwidth)   | FCC PART 15 C section 15.247 (a)(2)                 | ANSI C63.10: Clause 11.8                            | PASS   |
| Maximum Average Conducted Output Power   | FCC PART 15 C section 15.247(b)(3)                  | ANSI C63.10: Clause 11.9.2.3.1                      | PASS   |
| Peak Power Spectral Density  | FCC PART 15 C section 15.247(e)                     | ANSI C63.10: Clause 11.10.2                         | PASS   |
| Out of Band Conducted Emissions  | FCC PART 15 C section 15.209 &15.247(d)             | ANSI C63.10: Clause 11.11                           | PASS   |
| Out of Band Radiated Emission  | FCC PART 15 C section 15.209 &15.247(d)             | ANSI C63.10: Clause 11.11, 6.4, 6.5 and 6.6         | N/A    |
| Radiated Emissions in Restricted Bands   | FCC PART 15 C section 15.209 &15.247(d)             | ANSI C63.10: Clause 11.12.1, 6.4, 6.5 and 6.6       | PASS   |
| Band Edges Measurement   | FCC PART 15 C section 15.247 (d) &15.205            | ANSI C63.10: Clause 11.11 and 11.13                 | PASS   |
| Conducted Emissions at Mains Terminals   | FCC PART 15 C section 15.207                        | ANSI C63.10: Clause 6.2                             | PASS   |
| <p><b>Remark:</b><br/> <b>N/A:</b> not applicable. Refer to the relative section for the details.<br/> <b>EUT:</b> In this whole report EUT means Equipment Under Test.<br/> <b>Tx:</b> In this whole report Tx (or tx) means Transmitter.<br/> <b>Rx:</b> In this whole report Rx (or rx) means Receiver.<br/> <b>RF:</b> In this whole report RF means Radio Frequency.<br/> <b>ANSI C63.10:</b> the detail version is ANSI C63.10:2013 in the whole report.<br/> <b>Models KF-P20W, KF-P21W, KF-P22W</b> only have differences in appearance and model names, no difference in circuit and design structure, Model KF-P20W is selected for testing.</p> |   |   |        |

**TEST REPORT**

**2.0 General Description**

**2.1 Product Description**

Operating Frequency: 2412 MHz to 2462 MHz for 802.11b/g/n(HT20)  
 Type of Modulation: 802.11b: DSSS(CCK/QPSK/BPSK)  
 802.11g: OFDM(BPSK/QPSK/16QAM/64QAM)  
 802.11n: OFDM (BPSK/QPSK/16QAM/64QAM)  
 Transmit Data Rate: 802.11b :1/2/5.5/11 Mbps  
 802.11g :6/9/12/18/24/36/48/54 Mbps  
 802.11n(HT20): 6.5/13/19.5/26/39/52/58.5/65 Mbps/72.2Mbps  
 Number of Channels 11 Channels for 802.11b/g/n(HT20)  
 Channel Separation: 5 MHz  
 Antenna Type PCB antenna  
 EUT Power Supply: 120VAC 60Hz  
 Power cord: N/A

EUT channels and frequencies list:

For 802.11b/g/n(HT20): test frequencies are lowest channel 1: 2412 MHz, middle channel 6: 2437 MHz and highest channel 11: 2462 MHz.

| Channel | Frequency (MHz) | Channel | Frequency (MHz) |
|---------|-----------------|---------|-----------------|
| 1       | 2412            | 7       | 2442            |
| 2       | 2417            | 8       | 2447            |
| 3       | 2422            | 9       | 2452            |
| 4       | 2427            | 10      | 2457            |
| 5       | 2432            | 11      | 2462            |
| 6       | 2437            | /       |                 |

**2.2 Related Submittal(s) Grants**

This is an application for certification of:

DTS- Part 15 Digital Transmission Systems (Wi-Fi/BLE transmitter portion)

Remaining portions are subject to the following procedures:

1. Receiver portion of Wi-Fi/BLE: exempt from technical requirement of this Part.
2. This device is powered by 120VAC: FCC SDOC requirement.

## TEST REPORT

### 2.3 Test Methodology

Both AC mains line-conducted and radiated emission measurements were performed according to the procedures in ANSI C63.10. Radiated emission measurement was performed in semi-anechoic chamber and conducted emission measurement was performed in shield room. For radiated emission measurement, preliminary scans and final tests were performed in the semi-anechoic chamber to determine the worst case modes. All radiated tests were performed at an antenna to EUT distance of 3 meters, unless stated otherwise.

### 2.4 Test Facility

All tests were performed at:

Intertek Testing Services Shenzhen Ltd. Guangzhou Branch  
Room102/104, No 203, KeZhu Road, Science City, GETDD Guangzhou, China

Except Conducted Emissions was performed at:

Room 02, & 101/E201/E301/E401/E501/E601/E701/E801 of Room 01 1-8/F., No. 7-2.  
Caipin Road, Science City, GETDD, Guangzhou, Guangdong, China

A2LA Certificate Number 0078.10

Intertek Testing Services Shenzhen Ltd. Guangzhou Branch is accredited by A2LA and Listed in FCC website. FCC accredited test labs may perform both Certification testing under Parts 15 and 18 and Declaration of Conformity testing.

## 3.0 System Test Configuration

### 3.1 Justification

For emissions testing, the equipment under test (EUT) setup to transmit continuously to simplify the measurement methodology. Care was taken to ensure proper power supply voltages during testing. During testing, AC power line was manipulated to produce worst case emissions. It was powered by AC 120V supply.

The signal is maximized through rotation and placement in the three orthogonal axes. The antenna height and polarization are varied during the search for maximum signal level. The antenna height is varied from 1 to 4 meters. Radiated emissions are taken at three meters unless the signal level is too low for measurement at that distance. If necessary, a pre-amplifier is used and/or the test is conducted at a closer distance.

All readings are extrapolated back to the equivalent three meter reading using inverse scaling with distance. The spurious emissions more than 20 dB below the permissible value are not reported.

## TEST REPORT

For an intentional radiator, the spectrum shall be investigated from the lowest radio frequency signal generated in the device, without going below 9 kHz, up to at least the frequency shown in the following table:

Frequency range of radiated emission measurements

| Lowest frequency generated in the device | Upper frequency range of measurement  |
|--|---|
| 9 kHz to below 10 GHz                    | 10th harmonic of highest fundamental frequency or to 40 GHz, whichever is lower                             |
| At or above 10 GHz to below 30 GHz       | 5th harmonic of highest fundamental frequency or to 100 GHz, whichever is lower                             |
| At or above 30 GHz                       | 5th harmonic of highest fundamental frequency or to 200 GHz, whichever is lower, unless otherwise specified |

Number of fundamental frequencies to be tested in EUT transmit band

| Frequency range in which device operates | Number of frequencies | Location in frequency range of operation    |
|--|-----------------------|---|
| 1 MHz or less                            | 1                     | Middle                                      |
| 1 MHz to 10 MHz                          | 2                     | 1 near top and 1 near bottom                |
| More than 10 MHz                         | 3                     | 1 near top, 1 near middle and 1 near bottom |

### 3.2 EUT Exercising Software

Ameba72\_mptool\_1v3.

### 3.3 Special Accessories

No special accessories used.

## TEST REPORT

### 3.4 Measurement Uncertainty

| No. | Item                                   | Measurement Uncertainty |
|-----|--|-------------------------|
| 1   | 20 dB Bandwidth                        | 2.3%                    |
|     | 6dB Bandwidth                          |                         |
|     | 99% Bandwidth                          |                         |
| 2   | Carrier Frequencies Separated          | 2.3%                    |
| 3   | Dwell Time                             | 1.2%                    |
| 4   | Maximum Peak Conducted Output Power    | 1.5dB                   |
| 5   | Peak Power Spectral Density            | 1.5dB                   |
| 6   | Out of Band Conducted Emissions        | 1.5dB                   |
| 7   | Band edges measurement                 | 1.5dB                   |
| 8   | Radiated Emissions                     | 4.7 dB (25 MHz-1 GHz)   |
|     |  | 4.8 dB (1 GHz-18 GHz)   |
|     |  | 5.21dB (18GZH-26GHz)    |
| 9   | Conducted Emissions at Mains Terminals | 2.58dB                  |
| 10  | Temperature                            | 0.5 °C                  |
| 11  | Humidity                               | 0.4 %                   |
| 12  | Time                                   | 1.2%                    |

The measurement uncertainty describes the overall uncertainty of the given measured value during the operation of the EUT.

Measurement uncertainty is calculated in accordance with ETSI TR 100 028-2001.

The measurement uncertainty is given with a confidence of 95%, k=2.

When determining of the test conclusion, the Measurement Uncertainty of test has been considered.

Uncertainty and Compliance – Unless the standard specifically states that measured values are to be extended by the measurement uncertainty in determining compliance, all compliance determinations are based on the actual measured value

### 3.5 Equipment Modification

Any modifications installed previous to testing by Foshan Samyoo Electronic Co., Ltd will be incorporated in each production model sold / leased in the United States.

No modifications were installed by Intertek Testing Services Shenzhen Ltd. Guangzhou Branch.



**TEST REPORT**

**3.6 Support Equipment List and Description**

This product was tested with corresponding support equipment as below:

Support Equipment

| Description   | Manufacturer | Model No.    | SN/Version    | Supplied by |
|---------------|--------------|--------------|---------------|-------------|
| NoteBook      | HP           | Compaq 6710b | SN:CNU8240LF9 | Intertek    |
| Control board | --           | CNMDIP34     | Version:1.3   | clint       |

Cable

| Description        | Model No. | Connector type | Cable length/type | Supplied by |
|--------------------|-----------|----------------|-------------------|-------------|
| Antenna cable      | RF-01     | SMA            | 0.2 m(unshielded) | Intertek    |
| USB extension cord | USB-01    | USB            | 0.3 m(unshielded) | clint       |

Remark:

After the frequency was fixed, Notebook and Fix board were removed out of the Chamber before test.

## TEST REPORT

### 4.0 Measurement Results

#### 4.1 Antenna Requirement

Standard requirement:

15.203 requirement:

For intentional device. According to 15.203 an intentional radiator shall be designed to Ensure that no antenna other than that furnished by the responsible party shall be used with the device.

15.247(c) (1)(i) requirement:

(i) Systems operating in the 2400-2483.5 MHz bands that are used exclusively for fixed. Point-to-point operations may employ transmitting antennas with directional gain greater than 6 dBi provided the maximum conducted output power of the intentional radiator is reduced by 1 dB for every 3 dB that the directional gain of the antenna exceeds 6 dBi.

EUT Antenna

The antenna is an integral antenna and no consideration of replacement. The best case gain of the antenna is 2.54 dBi.



## TEST REPORT

### 4.2 6 dB Bandwidth (DTS bandwidth)

|                     |  |
|---------------------|--|
| Test Requirement:   | FCC Part 15 C section 15.247<br>(a)(2)Systems using digital modulation techniques may operate in the 902-928 MHz, 2400-2483.5MHz, and 5725-5850 MHz bands. The minimum 6 dB bandwidth shall be at least 500 kHz.   |
| Test Method:        | ANSI C63.10: Clause 11.8   |
| Test Status:        | Pre-Scan has been conducted to determine the worst-case mode from all possible combinations between available modulations, data rates and antenna ports (if EUT with antenna diversity architecture). Following channel(s) was (were) selected for the final test as listed below. |
| Test Configuration: |  |

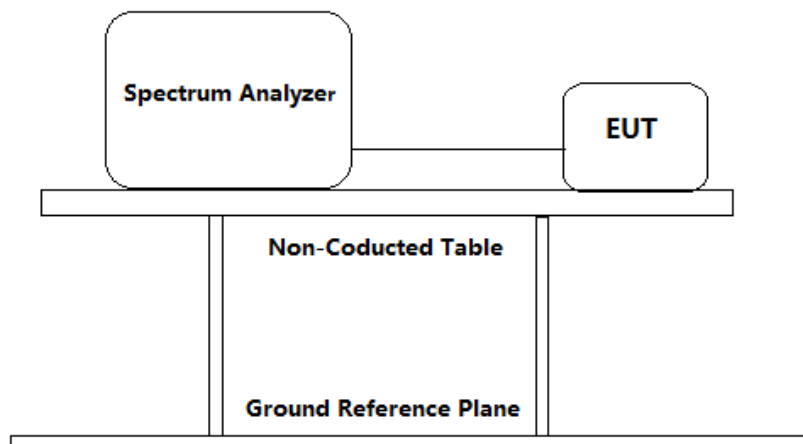

#### Test Procedure:

1. Remove the antenna from the EUT and then connect a low attention attenuation RF cable (cable loss =1 dB, with 10dB attenuator) from the antenna port to the spectrum.
2. Set the spectrum analyzer:
  - a) Set RBW = 100 kHz
  - b) Set the VBW  $\geq [3 \times \text{RBW}]$
  - c) Detector = peak.
  - d) Trace mode = max hold.
  - e) Sweep = auto couple
  - f) Allow the trace to stabilize.
  - g) Measure the maximum width of the emission that is constrained by the frequencies associated with the two outermost amplitude points (upper and lower frequencies) that are attenuated by 6 dB relative to the maximum level measured in the fundamental emission.
  - h) Span=2\*BW~5\*BW
3. Repeat until all the test status is investigated.

**TEST REPORT**

4. Report the worst case.

**Used Test Equipment List**

Spectrum Analyzer. Refer to Clause 5 Test Equipment List for details.

| Channel No. | Frequency (MHz) | Mode           | Data Rate | Measured 6dB bandwidth (MHz) | Limit   | Result |
|-------------|-----------------|----------------|-----------|------------------------------|---------|--------|
| 1           | 2412            | 802.11b        | 1 Mbps    | 10.130                       | ≥500KHz | Pass   |
| 6           | 2437            |                | 1 Mbps    | 10.072                       |         | Pass   |
| 11          | 2462            |                | 1 Mbps    | 10.130                       |         | Pass   |
| 1           | 2412            | 802.11g        | 6 Mbps    | 16.671                       |         | Pass   |
| 6           | 2437            |                | 6 Mbps    | 16.671                       |         | Pass   |
| 11          | 2462            |                | 6 Mbps    | 16.640                       |         | Pass   |
| 1           | 2412            | 802.11n (HT20) | 6.5 Mbps  | 17.887                       |         | Pass   |
| 6           | 2437            |                | 6.5 Mbps  | 17.887                       |         | Pass   |
| 11          | 2462            |                | 6.5 Mbps  | 17.887                       |         | Pass   |

Test result: The unit does meet the FCC requirements.

**TEST REPORT**

Result plot as follows:

802.11b mode with 1Mbps data rate

Channel 1: 2.412GHz

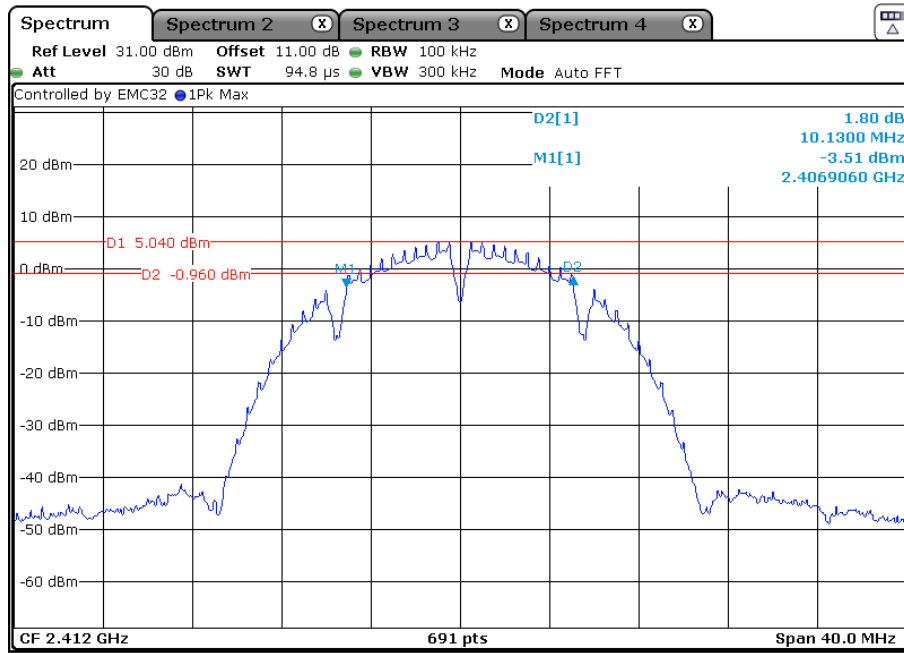

Channel 6: 2.437GHz:

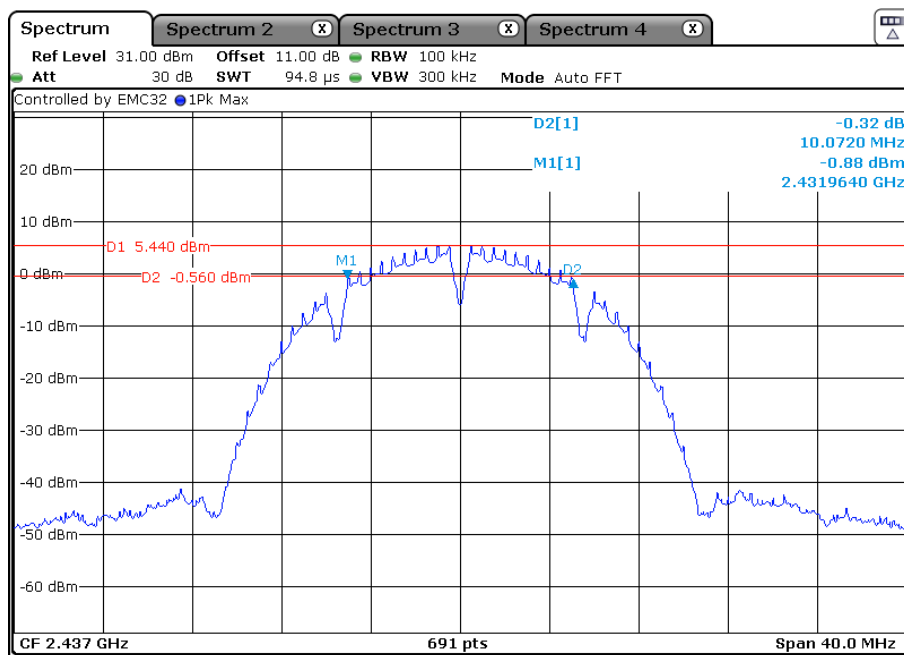

**TEST REPORT**

Channel 11: 2.462GHz:

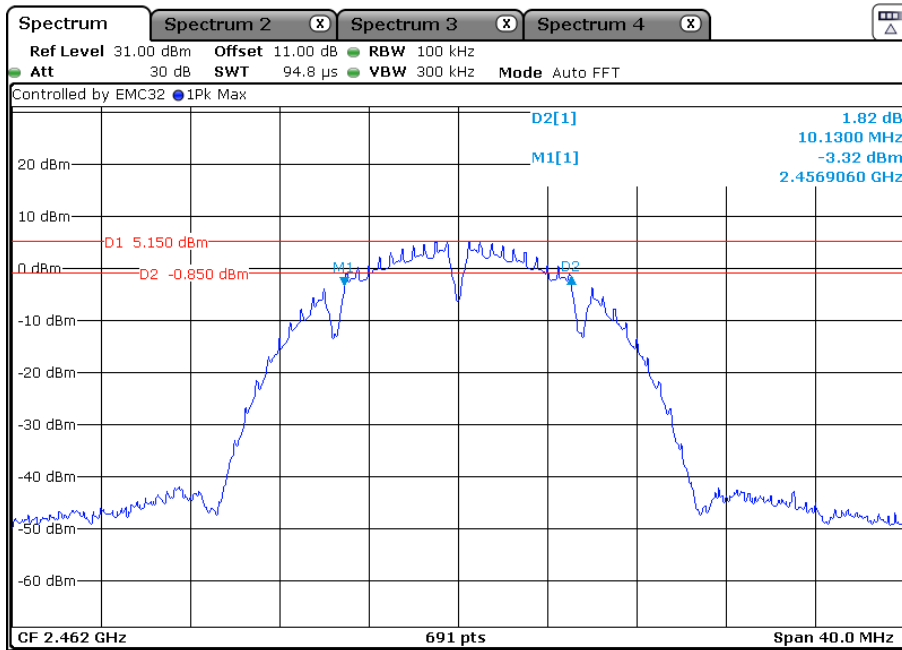

802.11g mode with 6Mbps data rate

Channel 1: 2.412GHz:

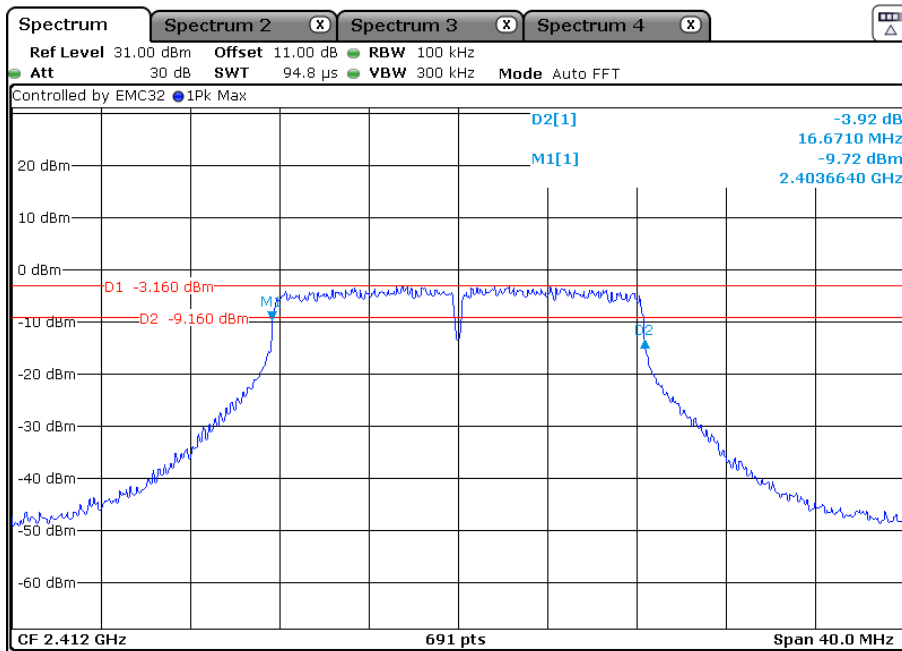

**TEST REPORT**

Channel 6: 2.437GHz:

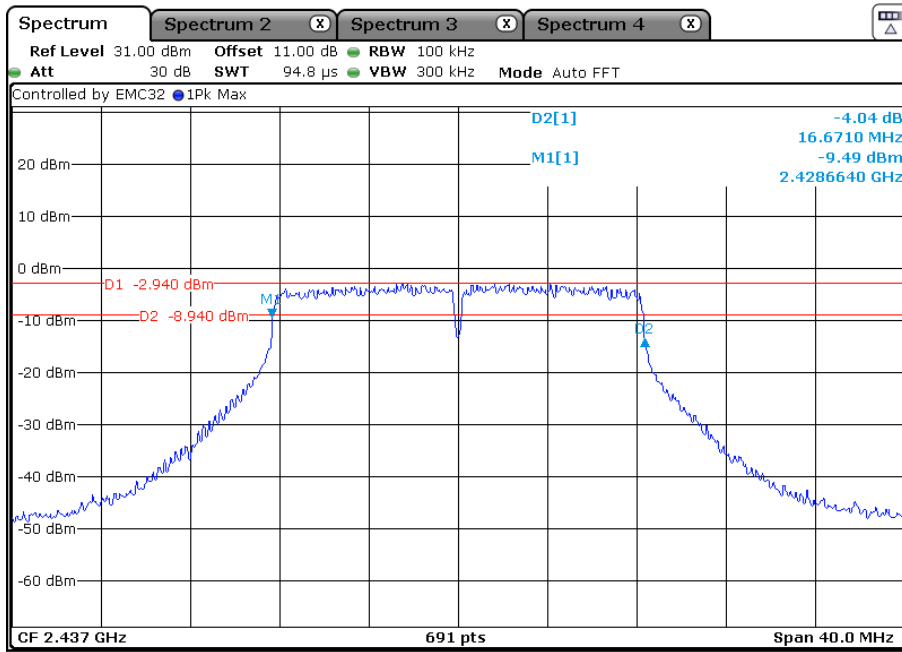

Channel 11: 2.462GHz:

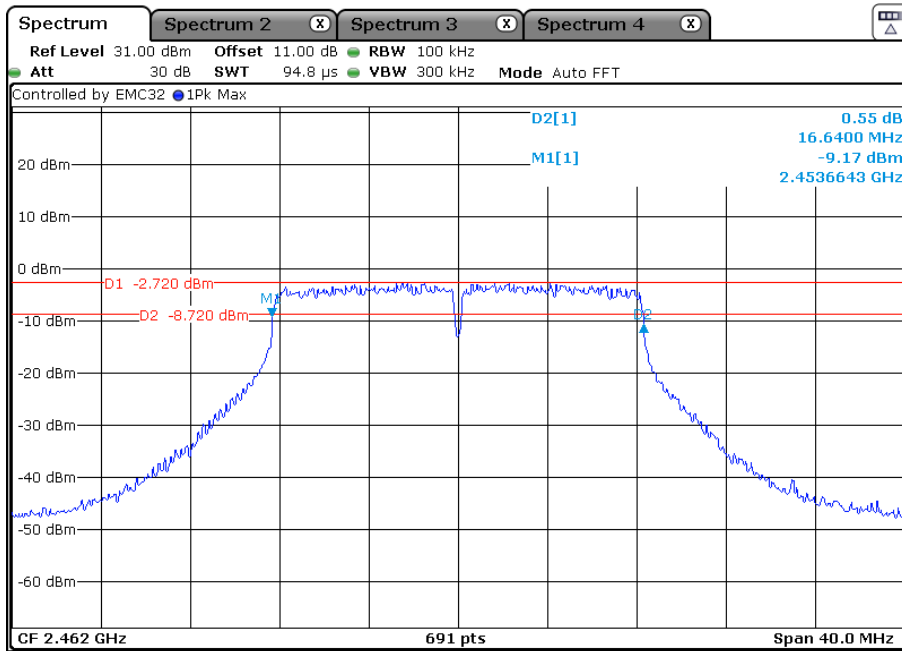

**TEST REPORT**

802.11n(HT20) mode with 6.5Mbps data rate

Channel 1: 2.412GHz:

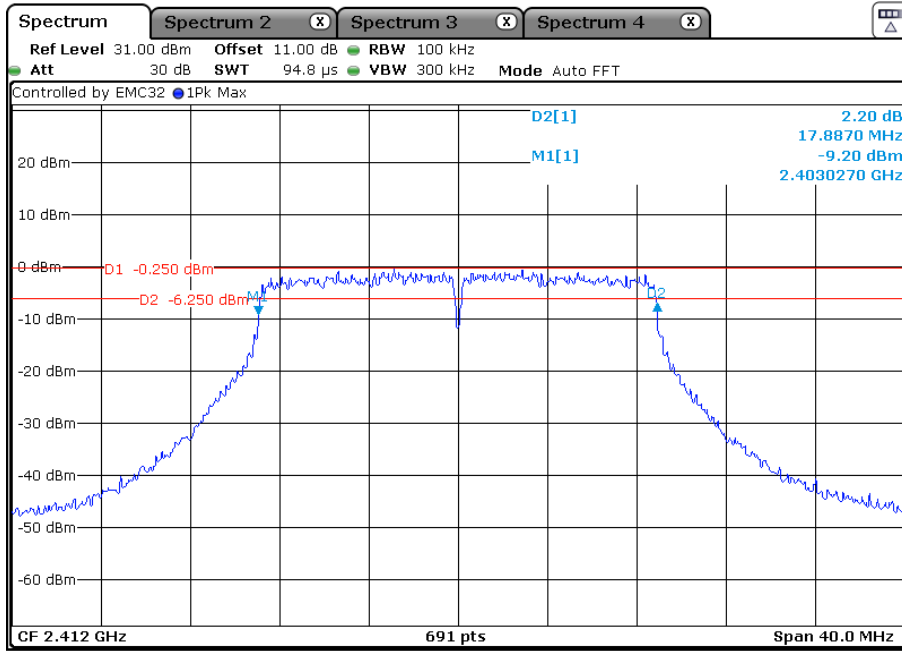

Channel 6: 2.437GHz:

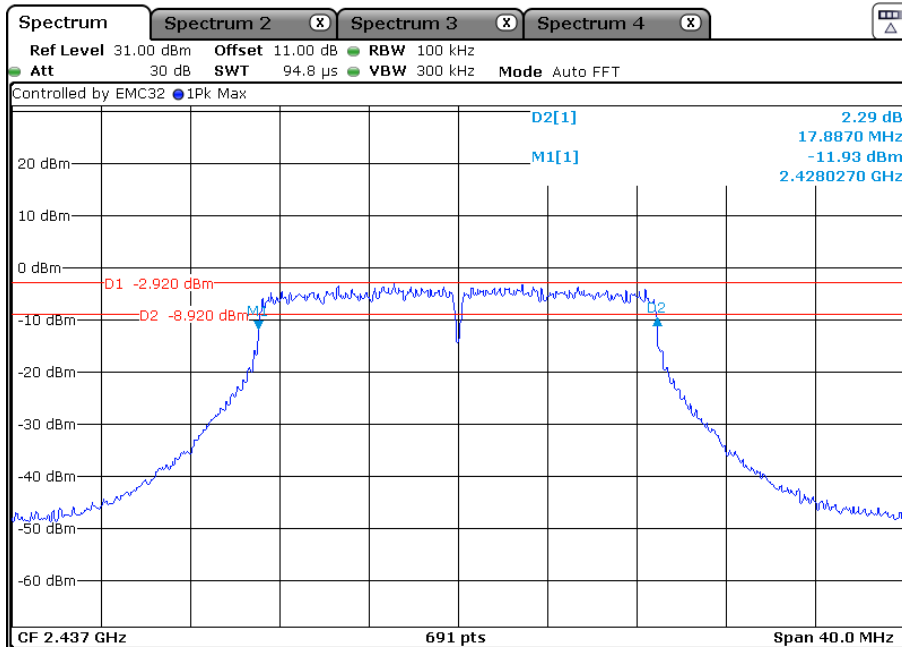



**TEST REPORT**

Channel 11: 2.462GHz:

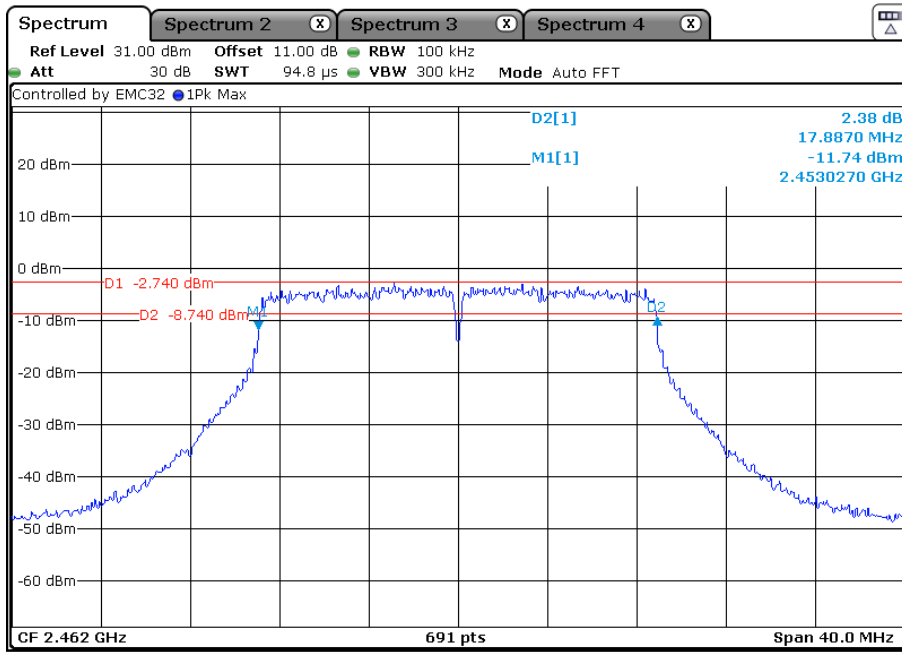

## TEST REPORT

### 4.3 Duty Cycle

Test Requirement: FCC KDB 558074 D01 15.247 Meas Guidance v05r02, Clause 6

Test Method: ANSI C63.10: Clause 11.6

Test Status: Pre-Scan has been conducted to determine the worst-case mode from all possible combinations between available modulations, data rates and antenna ports (if EUT with antenna diversity architecture). Following channel(s) was (were) selected for the final test as listed below.

Test Configuration:

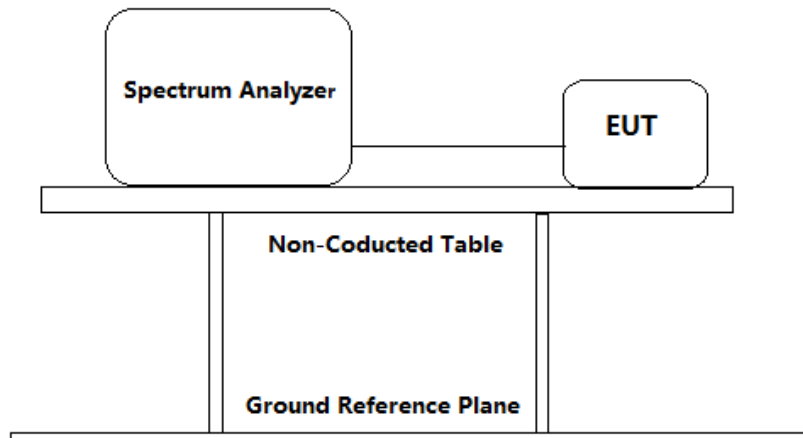

Test Procedure:

1. Remove the antenna from the EUT and then connect a low attention attenuation RF cable (cable loss =1dB, with a 10dB attenuator) from the antenna port to the spectrum.
2. Set the spectrum analyser:
  - a) Set the center frequency of the instrument to the center frequency of the transmission. Set the VBW  $\geq$  [3 x RBW]
  - b) Set RBW  $\geq$  OBW if possible; otherwise, set RBW to the largest available value. Span = Zero span
  - c) Set VBW  $\geq$  RBW. Set detector = peak or average. Trace mode = Free run
3. Report the worst case.

Used Test Equipment List

Spectrum Analyzer. Refer to Clause 5 Test Equipment List for details.

**TEST REPORT**

**Test result:**

| Channel No. | Frequency (MHz) | Mode           | On time (ms) | Period (ms) | Duty Cycle (%) |
|-------------|-----------------|----------------|--------------|-------------|----------------|
| 6           | 2437            | 802.11b        | 100          | 100         | 100            |
| 6           | 2437            | 802.11g        | 100          | 100         | 100            |
| 6           | 2437            | 802.11n (HT20) | 100          | 100         | 100            |

Result plot as follows:

802.11b mode

Channel 6: 2437 MHz:

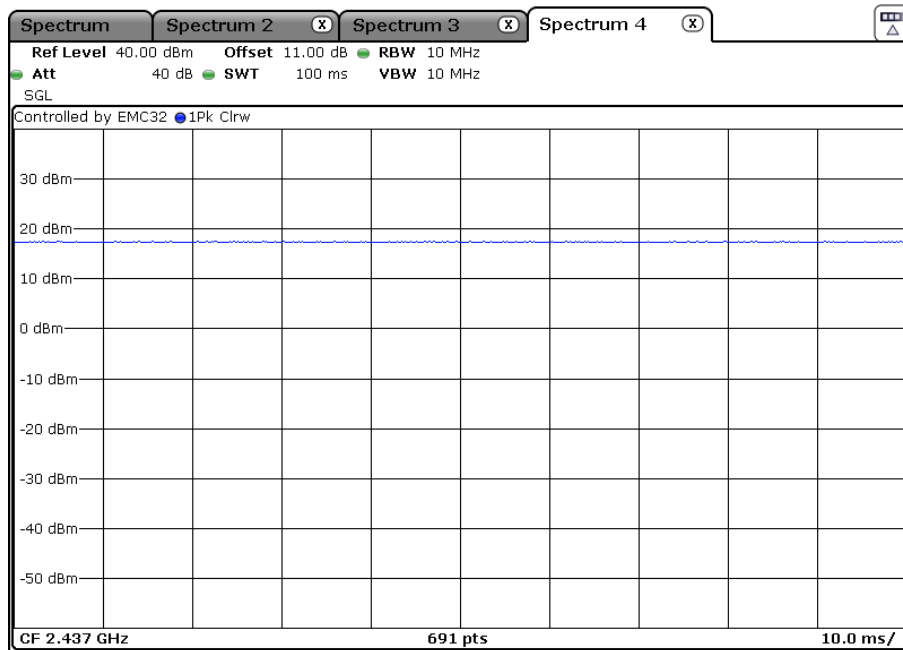

### TEST REPORT

802.11g mode

Channel 6: 2437 MHz:

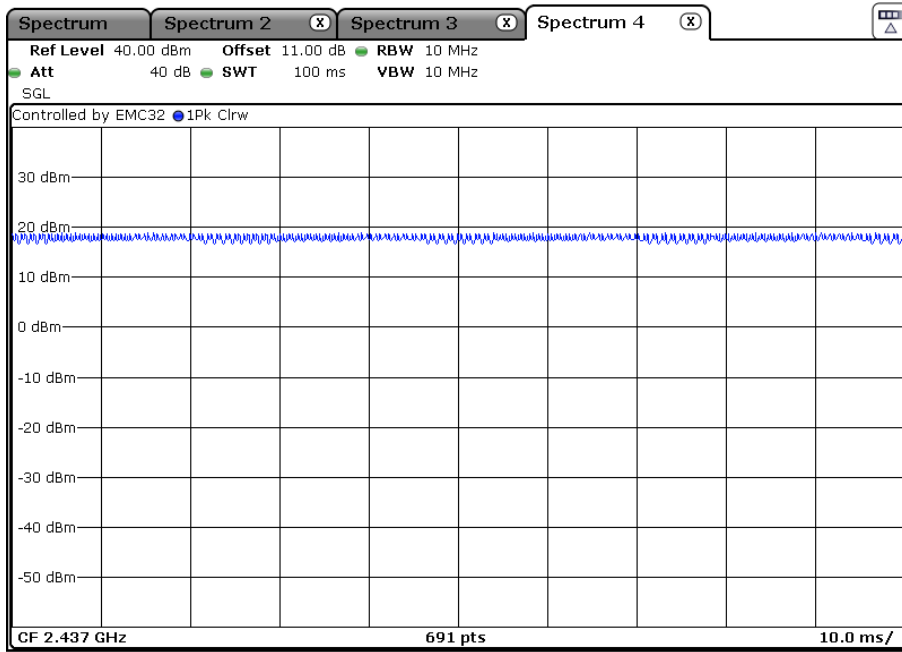

802.11n(HT 20) mode

Channel 6: 2437 MHz:

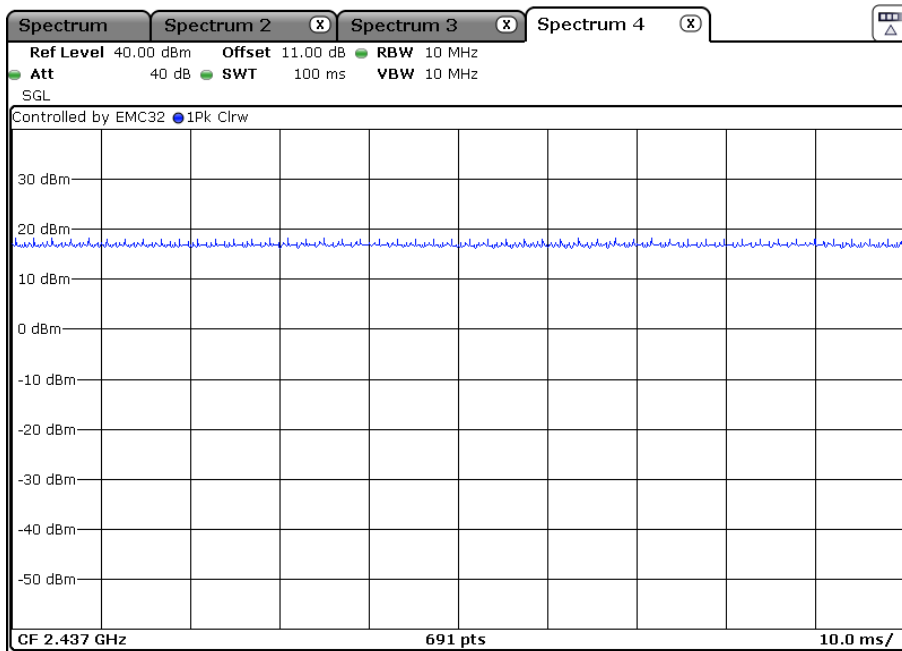

## TEST REPORT

### 4.4 Maximum Average Conducted Output Power

**Test Requirement:** FCC Part 15 C section 15.247  
(b)(3) For systems using digital modulation in the 902-928 MHz, 2400-2483.5 MHz, and 5725-5850 MHz bands: 1 Watt.  
Except as shown in paragraph (c) of this section, if transmitting antennas of directional gain greater than 6 dBi are used, the conducted output power from the intentional radiator shall be reduced below the stated values in paragraphs (b) (1), (b) (2), and (b) (3) of this section, as appropriate, by the amount in dB that the directional gain of the antenna exceeds 6 dBi.

**Test Method:** ANSI C63.10: Clause 11.9.2.3.1

**Test Status:** Pre-Scan has been conducted to determine the worst-case mode from all possible combinations between available modulations, data rates and antenna ports (if EUT with antenna diversity architecture). Following channel(s) was (were) selected for the final test as listed below.

**Test Configuration:**

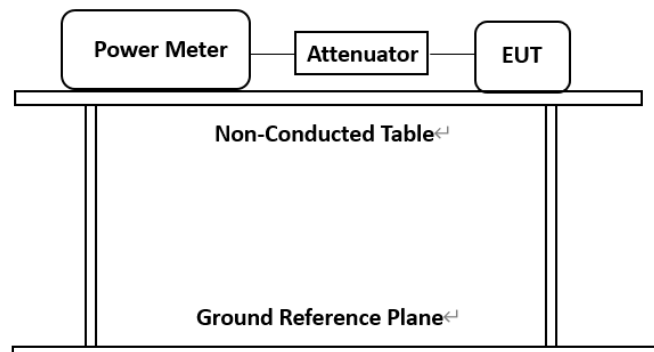

**Test Procedure:**

1. Remove the antenna from the EUT and then connect a low attention attenuation RF cable (cable loss =1 dB, with a 10dB attenuator) from the antenna port to the power meter.
2. The EUT is configured to transmit continuously or to transmit with a constant duty cycle.
3. If the EUT is transmitting at all times, it must be transmitting at its maximum power control level.
4. If the EUT does not transmit continuously, measure the duty cycle and adjust the measurement in dBm by adding  $10\log(1/x)$  where x is the duty cycle of transmitter output signal. This measurement is an average over both the ON and OFF periods of the transmitter.
5. Report the worst case.

**TEST REPORT**

Used Test Equipment List

Power meter. Refer to Clause 5 Test Equipment List for details.

**Test result:**

| Channel No. | Frequency (MHz) | Mode              | Data Rate | Measured Channel Power (dBm) | Limit         | Result |
|-------------|-----------------|-------------------|-----------|------------------------------|---------------|--------|
| 1           | 2412            | 802.11b           | 1 Mbps    | 16.4                         | 1W<br>(30dBm) | Pass   |
| 6           | 2437            |                   | 1 Mbps    | 16.8                         |               | Pass   |
| 11          | 2462            |                   | 1 Mbps    | 16.5                         |               | Pass   |
| 1           | 2412            | 802.11g           | 6 Mbps    | 12.8                         |               | Pass   |
| 6           | 2437            |                   | 6 Mbps    | 13.0                         |               | Pass   |
| 11          | 2462            |                   | 6 Mbps    | 13.2                         |               | Pass   |
| 1           | 2412            | 802.11n<br>(HT20) | 6.5 Mbps  | 12.2                         |               | Pass   |
| 6           | 2437            |                   | 6.5 Mbps  | 12.6                         |               | Pass   |
| 11          | 2462            |                   | 6.5 Mbps  | 12.8                         |               | Pass   |

Remark: The measured power in the table has considered the compensation of duty cycle.  
The unit does meet the FCC requirements.

## TEST REPORT

### 4.5 Peak Power Spectral Density

- Test Requirement:** FCC Part 15 C section 15.247  
(e) For digitally modulated systems, the power spectral density conducted from the intentional radiator to the antenna shall not be greater than 8 dBm in any 3 kHz band during any time interval of continuous transmission.  
This power spectral density shall be determined in accordance with the provisions of paragraph (b) of this section. The same method of determining the conducted output power shall be used to determine the power spectral density.
- Test Method:** ANSI C63.10: Clause 11.10.2
- Test Status:** Pre-Scan has been conducted to determine the worst-case mode from all possible combinations between available modulations, data rates and antenna ports (if EUT with antenna diversity architecture). Following channel(s) was (were) selected for the final test as listed below.

**Test Configuration:**

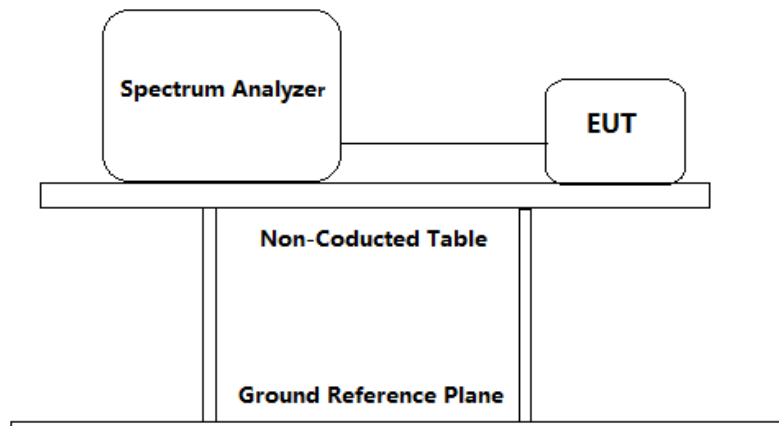

**Test Procedure:**

1. Remove the antenna from the EUT and then connect a low attention attenuation RF cable (cable loss =1dB, with 10 dB attenuator) from the antenna port to the spectrum analyzer or power meter.
2. Set the spectrum analyzer:
  - a) Set analyzer center frequency to DTS channel center frequency.
  - b) Set the span=  $1.5 \times$  DTS bandwidth.
  - c) Set the RBW to  $3 \text{ kHz} \leq \text{RBW} \leq 100 \text{ kHz}$ .
  - d) Set the VBW  $\geq [3 \times \text{RBW}]$ .
  - e) Detector = peak.
  - f) Sweep time = auto couple.
  - g) Trace mode = max hold.
  - h) Allow trace to fully stabilize.
  - i) Use the peak marker function to determine the maximum amplitude level within

## TEST REPORT

the RBW.

j) If measured value exceeds requirement, then reduce RBW (but no less than 3 kHz) and repeat.

3. Measure the Power Spectral Density of the test frequency with special test status.
4. Repeat until all the test status is investigated.
5. Report the worst case.

### Used Test Equipment List

Spectrum Analyzer. Refer to Clause 5 Test Equipment List for details.

Test result:

| Channel No. | Frequency (MHz) | Mode              | Data Rate | Measured Peak Power Spectral Density (dBm/3kHz) | Limit          | Result |
|-------------|-----------------|-------------------|-----------|---|----------------|--------|
| 1           | 2412            | 802.11b           | 1 Mbps    | -15.67  | 8dBm/<br>3 KHz | Pass   |
| 6           | 2437            |                   | 1 Mbps    | -15.22  |                | Pass   |
| 11          | 2462            |                   | 1 Mbps    | -15.52  |                | Pass   |
| 1           | 2412            | 802.11g           | 6 Mbps    | -17.82  |                | Pass   |
| 6           | 2437            |                   | 6 Mbps    | -17.63  |                | Pass   |
| 11          | 2462            |                   | 6 Mbps    | -17.34  |                | Pass   |
| 1           | 2412            | 802.11n<br>(HT20) | 6.5 Mbps  | -15.15  |                | Pass   |
| 6           | 2437            |                   | 6.5 Mbps  | -17.85  |                | Pass   |
| 11          | 2462            |                   | 6.5 Mbps  | -17.60  |                | Pass   |



### TEST REPORT

Result plot as follows:

802.11b mode with 1Mbps data rate

Channel 1: 2.412GHz:

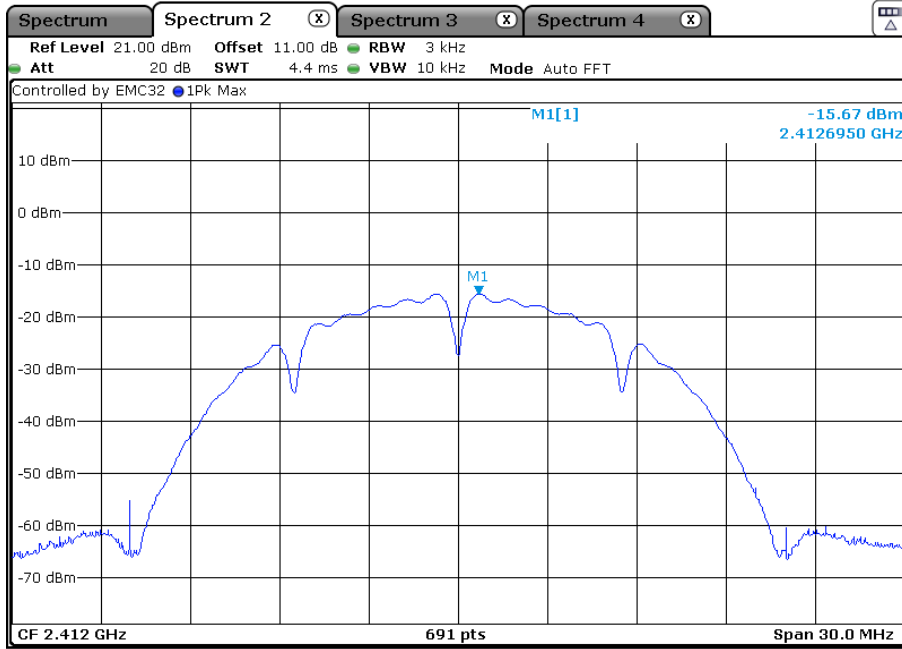

Channel 6: 2.437GHz:

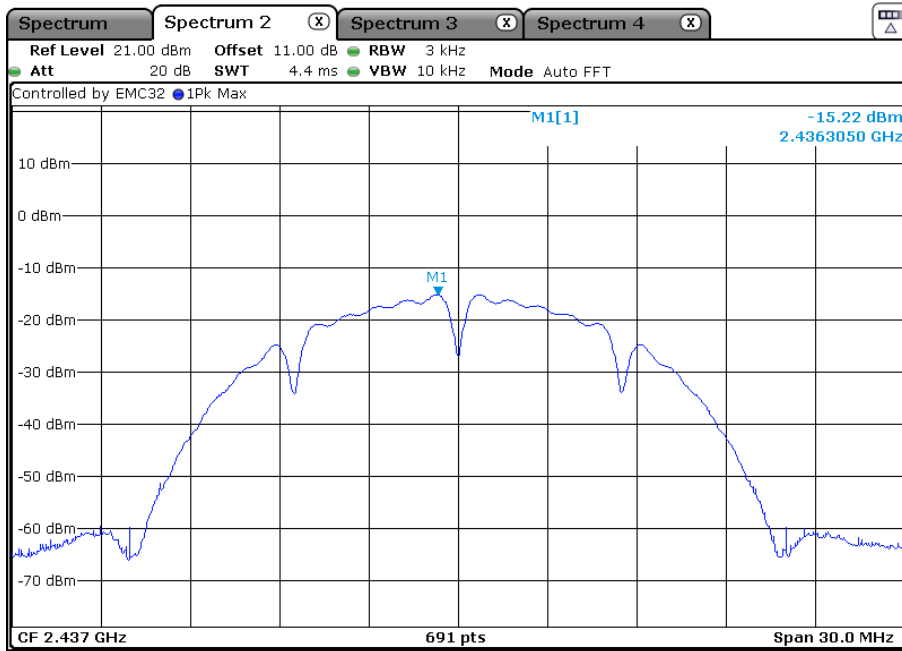

### TEST REPORT

Channel 11: 2.462GHz:

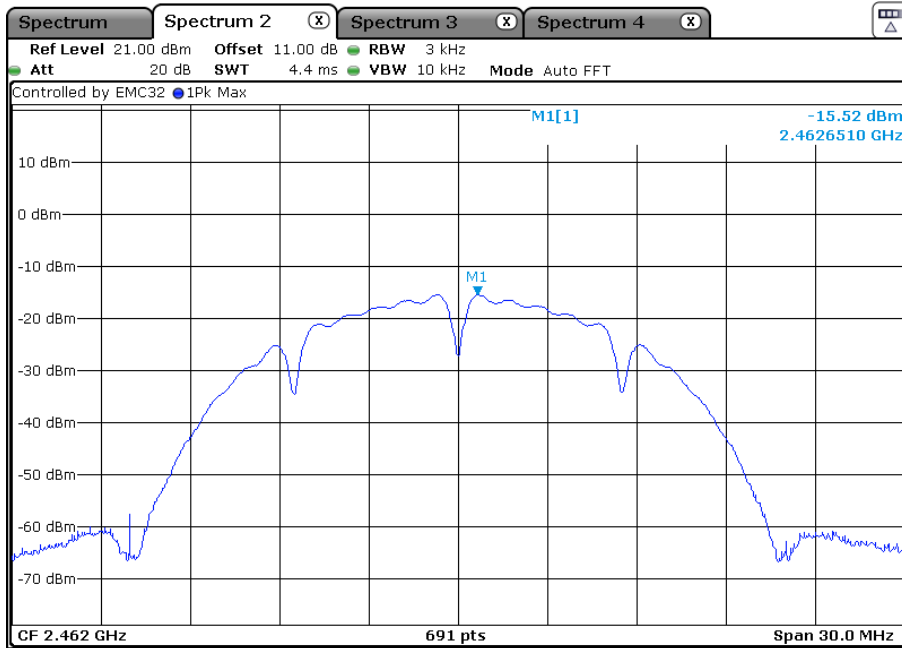

802.11g mode with 6Mbps data rate

Channel 1: 2.412GHz:

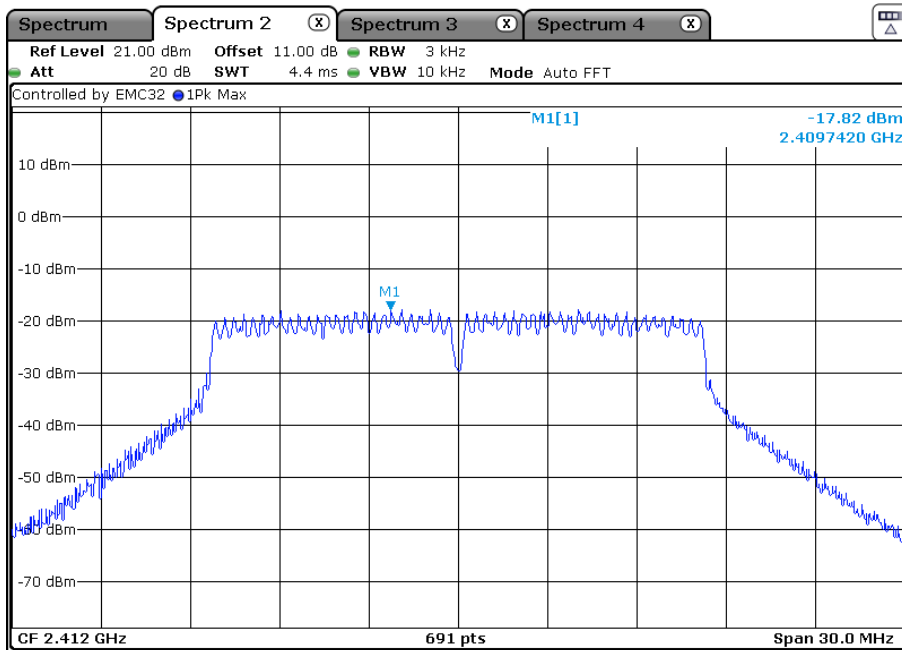

**TEST REPORT**

Channel 6: 2.437GHz:

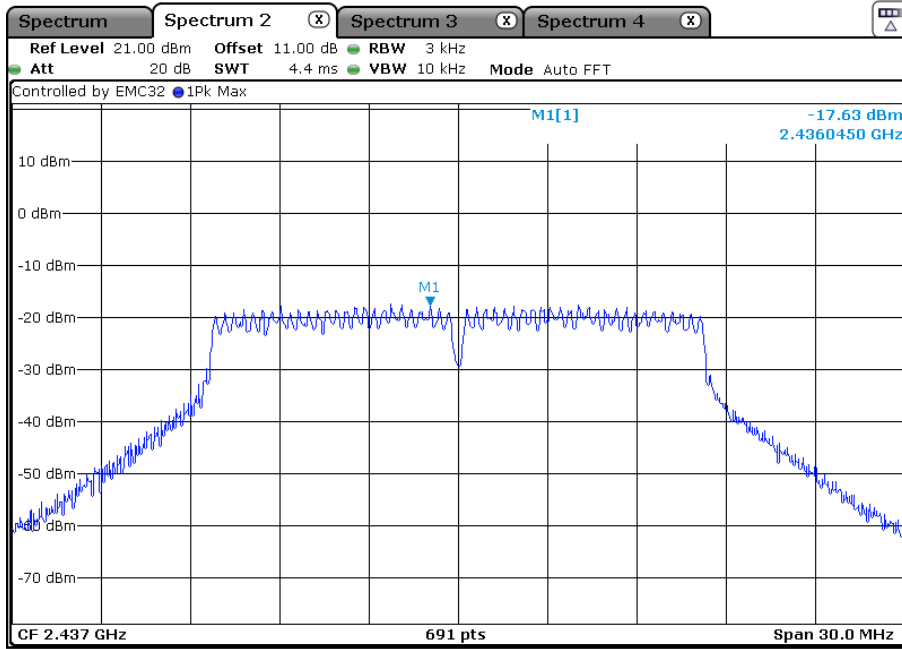

Channel 11: 2.462GHz:

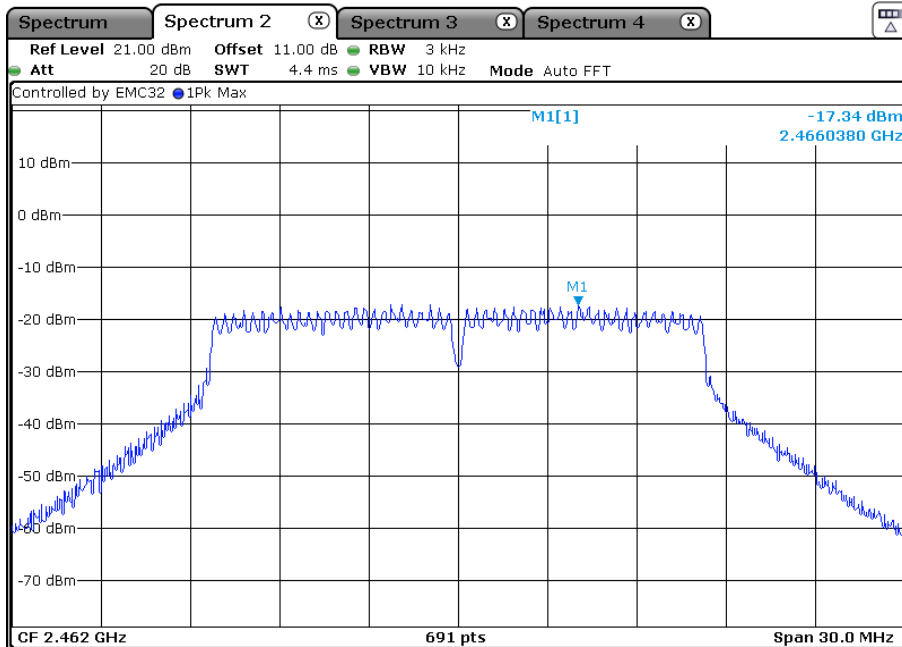

**TEST REPORT**

802.11n(HT20) mode with 6.5Mbps data rate  
Channel 1: 2.412GHz:

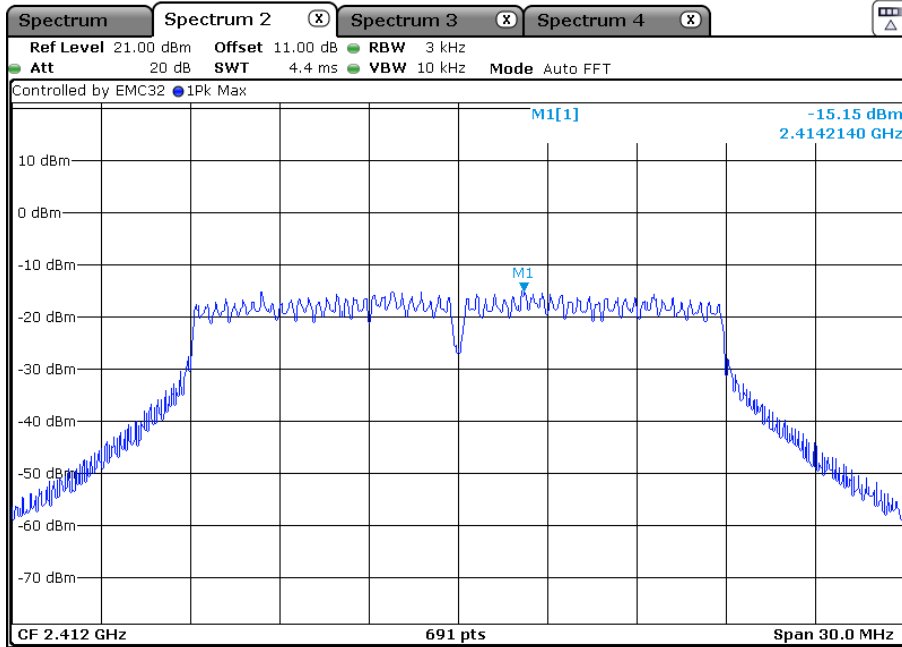

Channel 6: 2.437GHz:

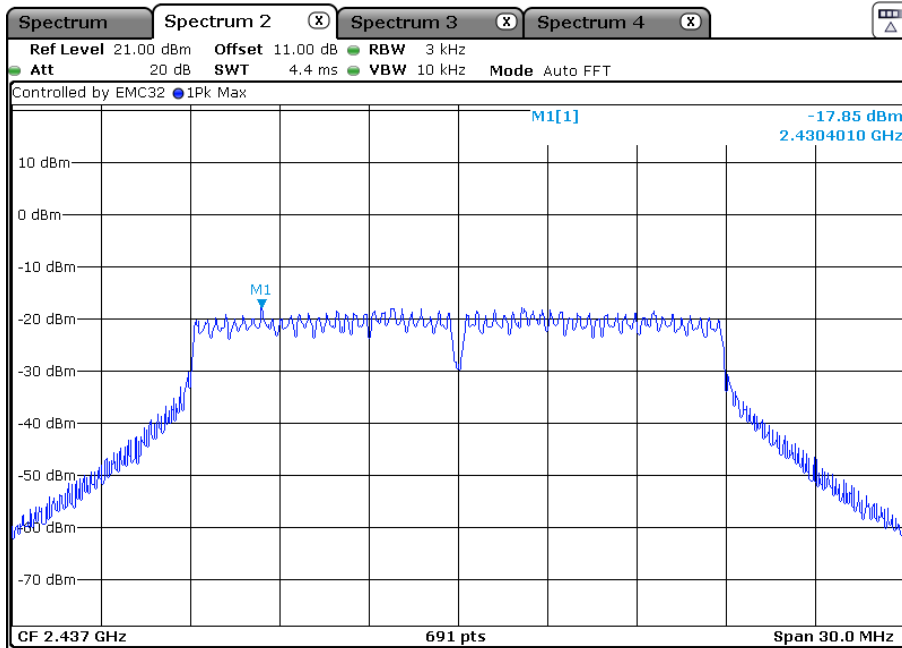

### TEST REPORT

Channel 11: 2.462GHz:

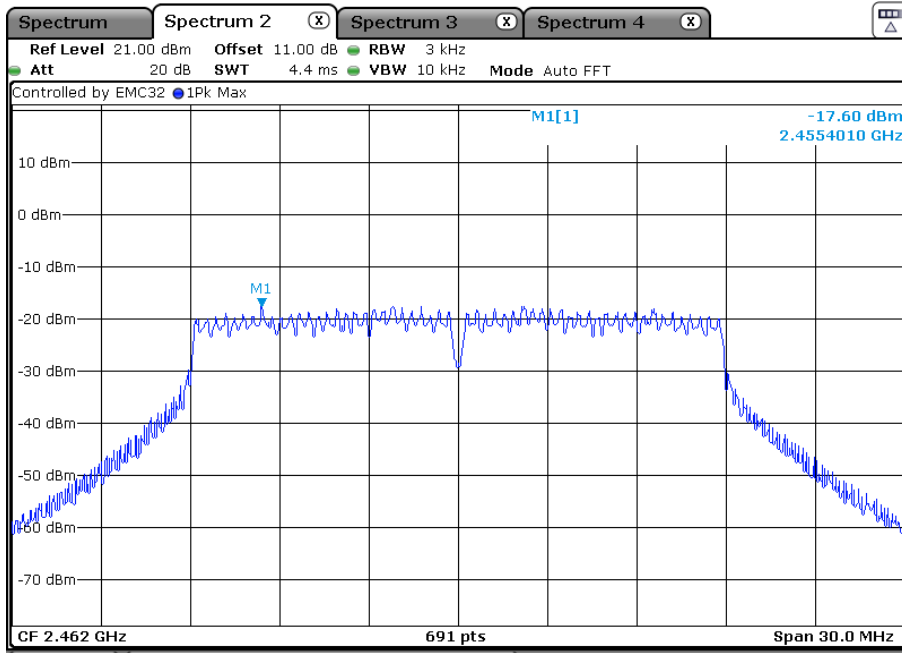

## TEST REPORT

### 4.6 Out of Band Conducted Emissions

Test Requirement: FCC Part 15 C section 15.247

(d) In any 100 kHz bandwidth outside the frequency band in which the spread spectrum or digitally modulated intentional radiator is operating. The radio frequency power that is produced by the intentional radiator shall be at least 20 dB below that in the 100 kHz bandwidth within the band that contains the highest level of the desired power. Based on either an RF conducted or a radiated measurement. Provided the transmitter demonstrates compliance with the peak conducted power limits. If the transmitter complies with the conducted power limits based on the use of RMS averaging over a time interval, as permitted under paragraph (b)(3) of this section, the attenuation required under this paragraph shall be 30dB instead of 20dB.

Test Method: ANSI C63.10: Clause 11.11

Test Status: Pre-Scan has been conducted to determine the worst-case mode from all possible combinations between available modulations, data rates and antenna ports (if EUT with antenna diversity architecture). Following channel(s) was (were) selected for the final test as listed below.

Test Configuration:

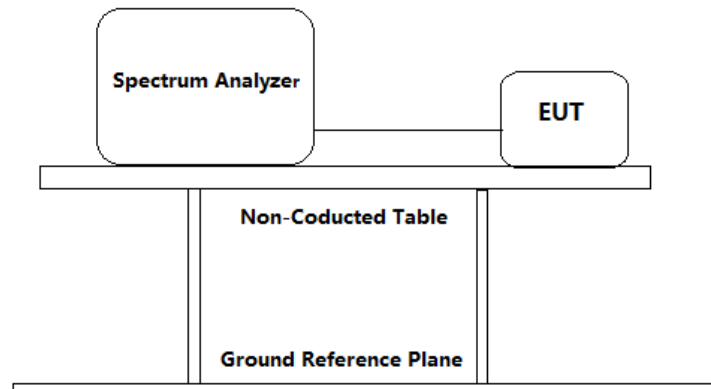

Test Procedure:

1. Remove the antenna from the EUT and then connect a low RF cable (cable loss =1dB, with 10 dB attenuator) from the antenna port to the spectrum analyzer or power meter.
2. Establish a reference level by using the following procedure:
  - a) Set instrument center frequency to DTS channel center frequency.
  - b) Set the span to  $\geq 1.5 \times$  DTS bandwidth.
  - c) Set the RBW = 100 kHz.
  - d) Set the VBW  $\geq [3 \times$  RBW].
  - e) Detector = peak.
  - f) Sweep time = auto couple.

## TEST REPORT

- g) Trace mode = max hold.
  - h) Allow trace to fully stabilize.
  - i) Use the peak marker function to determine the maximum PSD level.
- Note that the channel found to contain the maximum PSD level can be used to establish the reference level
- 3. Emission level measurement
    - a) Set the center frequency and span to encompass frequency range to be measured.
    - b) Set the RBW = 100 kHz.
    - c) Set the VBW  $\geq [3 \times \text{RBW}]$ .
    - d) Detector = peak.
    - e) Sweep time = auto couple.
    - f) Trace mode = max hold.
    - g) Allow trace to fully stabilize.
    - h) Use the peak marker function to determine the maximum amplitude level.
  - 4. Measure the Conducted unwanted Emissions of the test frequency with special test status.
  - 5. Repeat until all the test status is investigated.
  - 6. Report the worst case.

### Used Test Equipment List

Spectrum Analyzer. Refer to Clause 5 Test Equipment List for details.

Result plot as follows:

802.11b mode with 1Mbps data rate

Channel 1: 2.412GHz:

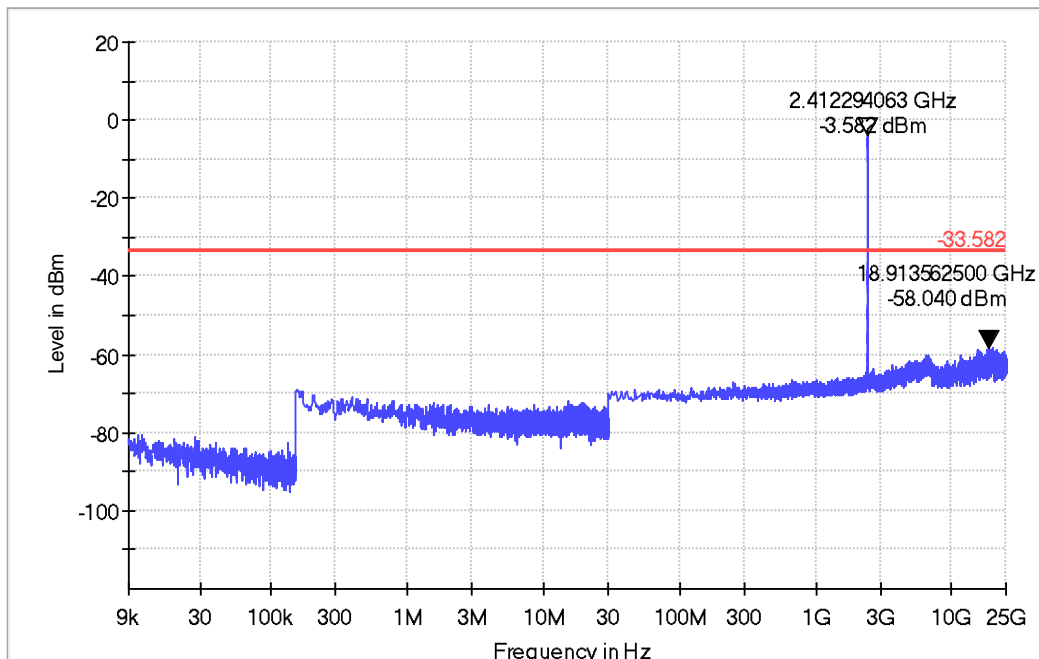

In any 100kHz bandwidth, the Conducted Spurious Emissions from 9 kHz to 25 GHz were greater than 30dB below the peak emission within the band that contains the highest level of

**TEST REPORT**

the desired power.

Channel 6: 2.437GHz:

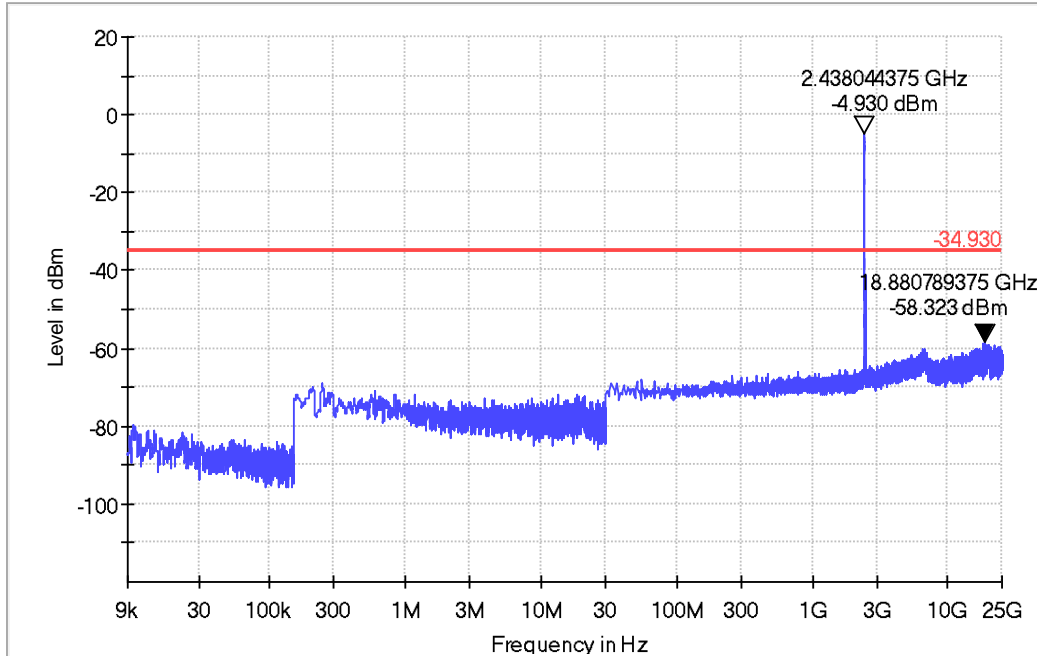

In any 100kHz bandwidth, the Conducted Spurious

us Emissions from 9 kHz to 25 GHz were greater than 30dB below the peak emission within the band that contains the highest level of the desired power.

Channel 11:2.462 GHz:



**TEST REPORT**

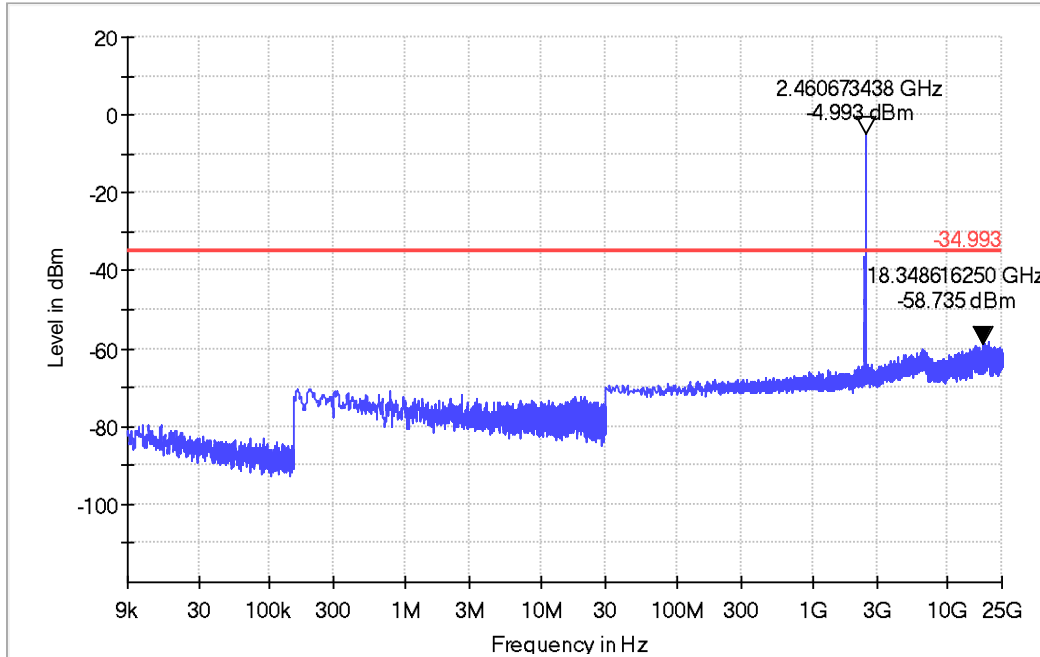

In any 100kHz bandwidth, the Conducted Spurious Emissions from 9 kHz to 25 GHz were greater than 30dB below the peak emission within the band that contains the highest level of the desired power.

802.11g mode with 6Mbps data rate

Channel 1: 2.412GHz:

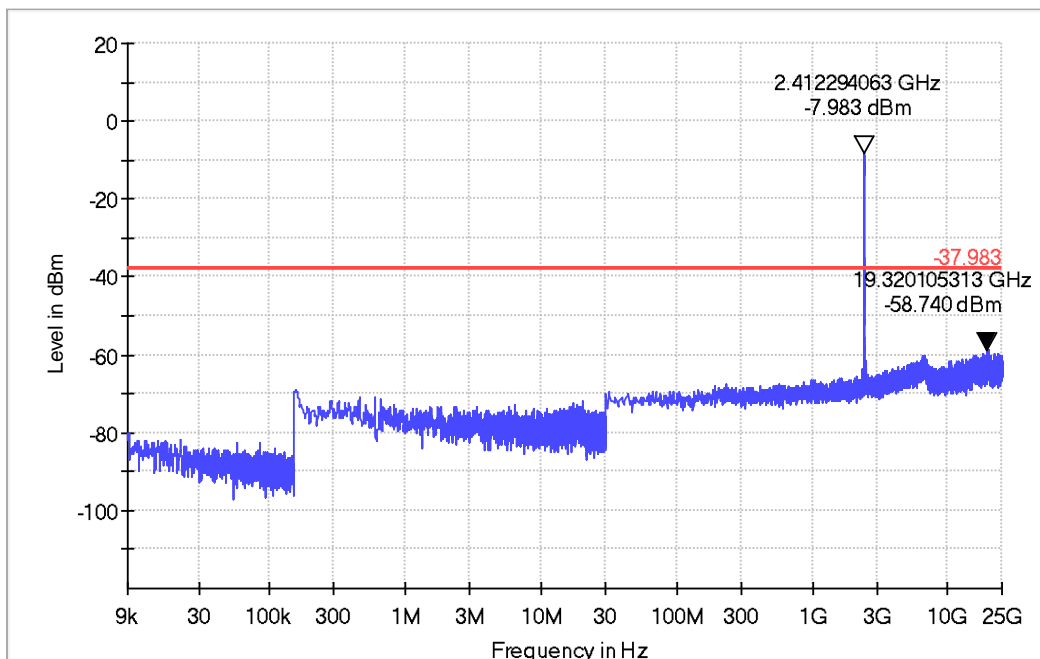

**TEST REPORT**

In any 100kHz bandwidth, the Conducted Spurious Emissions from 30 MHz to 25 GHz were greater than 30dB below the peak emission within the band that contains the highest level of the desired power.

Channel 6: 2.437GHz:

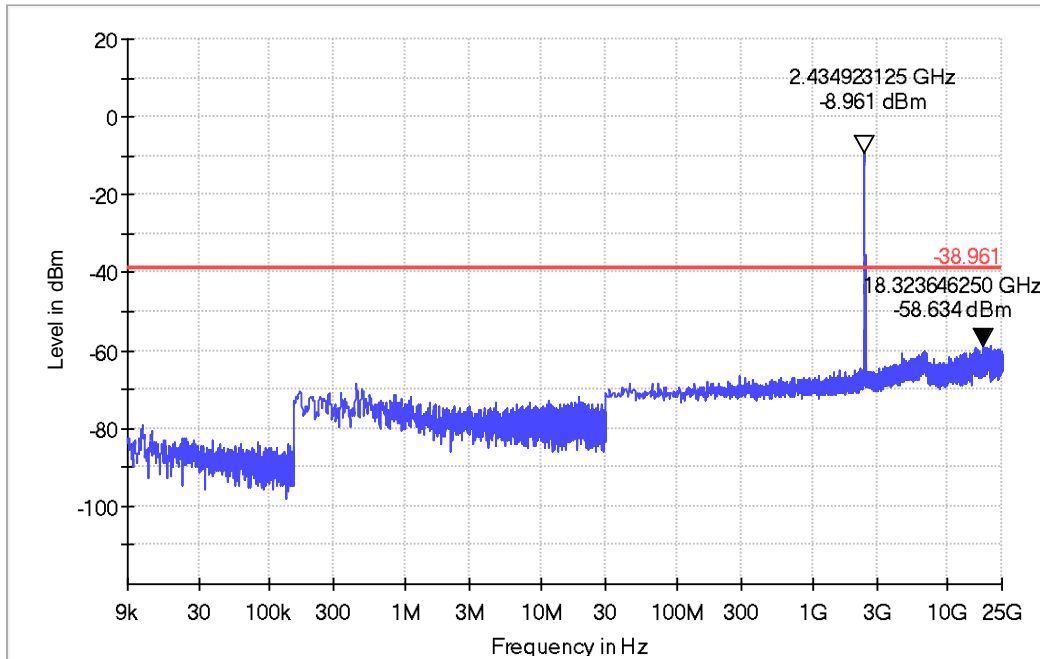

In any 100kHz bandwidth, the Conducted Spurious Emissions from 9 kHz to 25 GHz were greater than 30dB below the peak emission within the band that contains the highest level of the desired power.

Channel 11: 2.462 GHz:

**TEST REPORT**

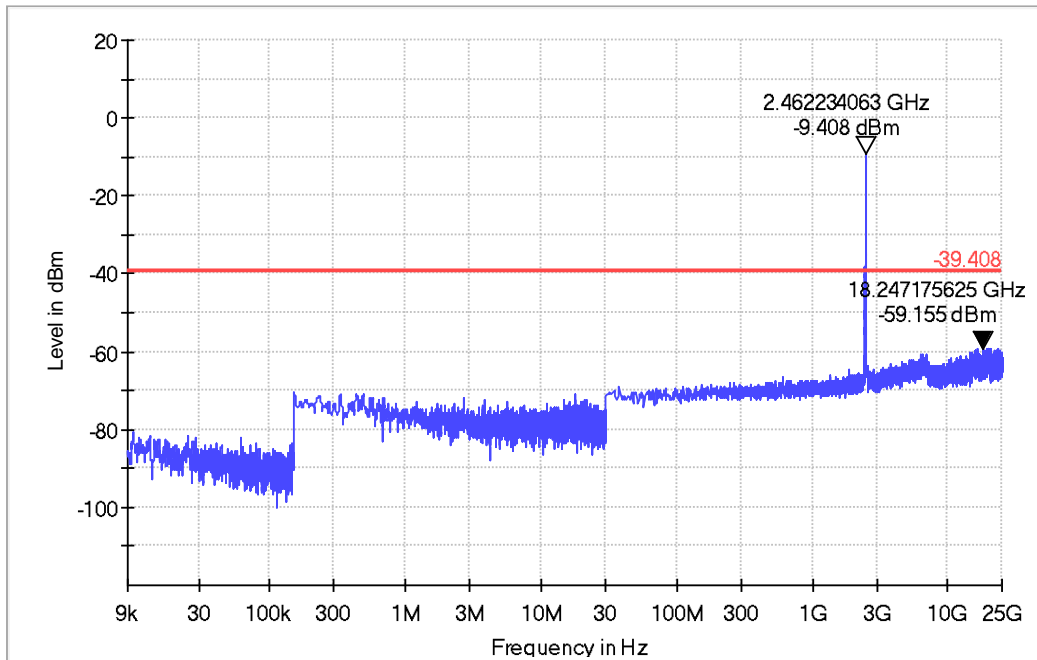

In any 100kHz bandwidth, the Conducted Spurious Emissions from 9 kHz to 25 GHz were greater than 30dB below the peak emission within the band that contains the highest level of the desired power.

802.11n(HT20) mode with 6.5Mbps data rate  
Channel 1: 2.412GHz:

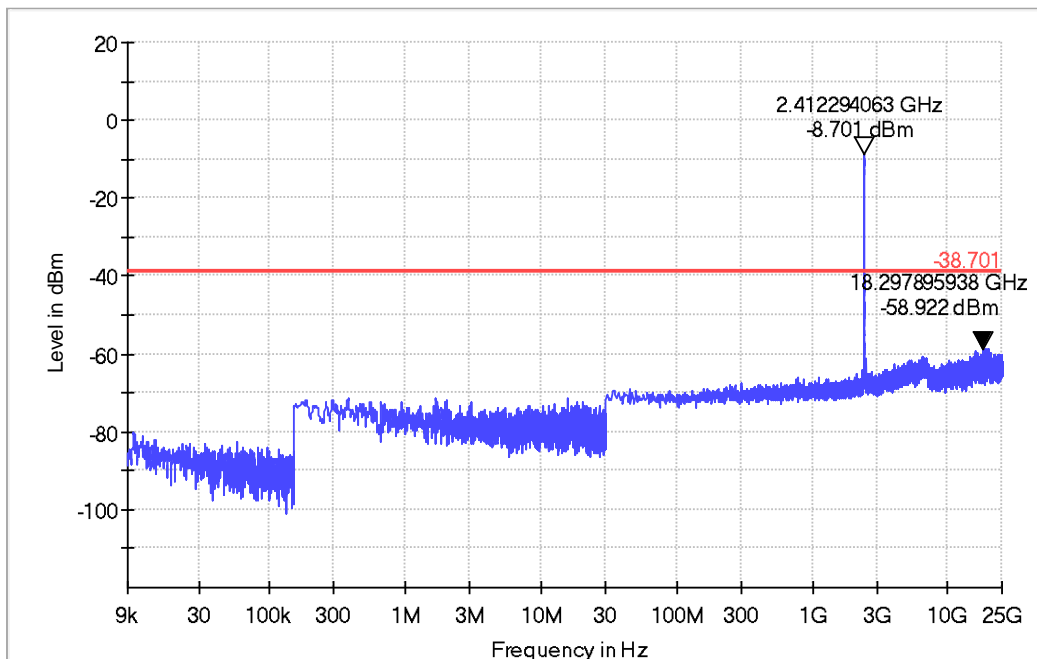

**TEST REPORT**

In any 100kHz bandwidth, the Conducted Spurious Emissions from 9 kHz to 25 GHz were greater than 30dB below the peak emission within the band that contains the highest level of the desired power.

Channel 6: 2.437GHz:

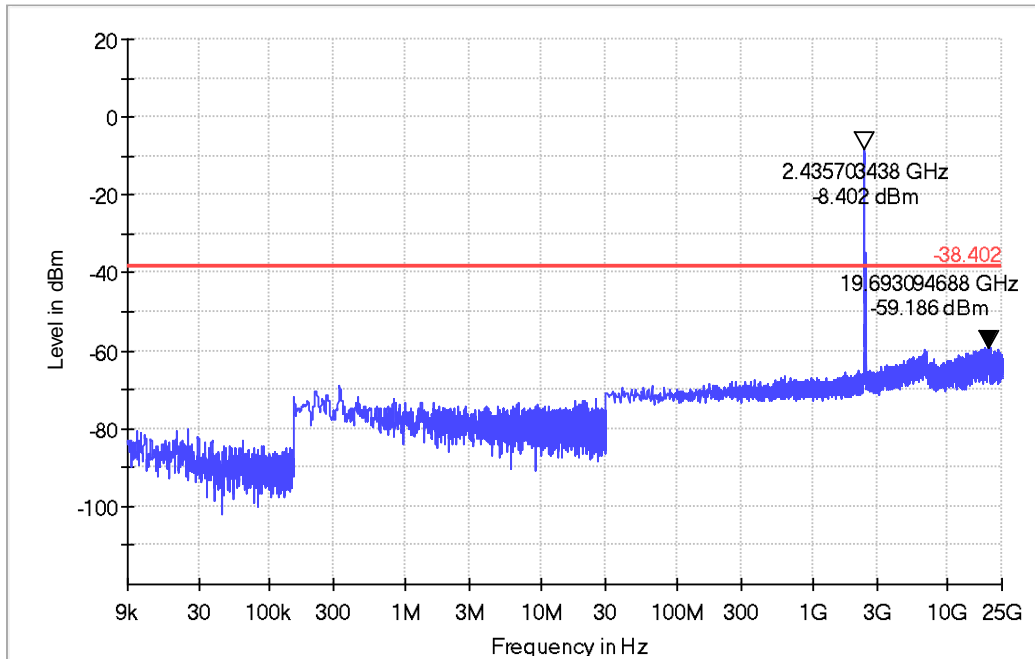

In any 100kHz bandwidth, the Conducted Spurious Emissions from 9 kHz to 25 GHz were greater than 30dB below the peak emission within the band that contains the highest level of the desired power.

Channel 11:2.462 GHz:

**TEST REPORT**

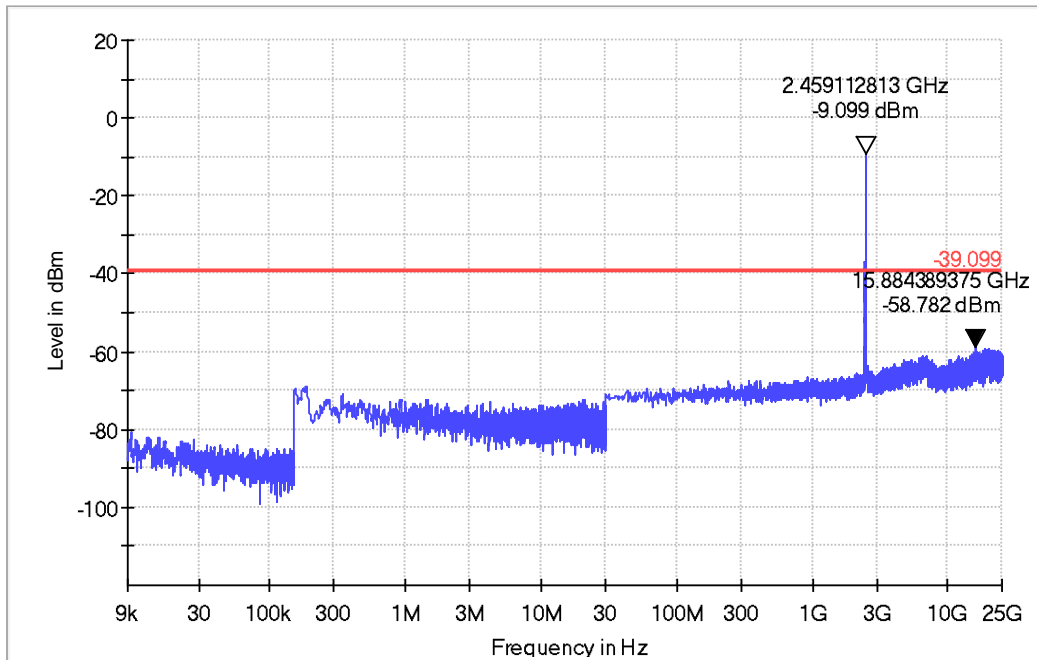

In any 100kHz bandwidth, the Conducted Spurious Emissions from 9 kHz to 25 GHz were greater than 30dB below the peak emission within the band that contains the highest level of the desired power.

**4.7 Out of Band Radiated Emissions**

For out of band radiated emissions into Non-Restricted Frequency Bands were performed at a 3m separation distance to determine whether these emissions complied with the 20dB attenuation requirement.

- Not required, since all emissions are more than 20dB below fundamental
- See attached data sheet

**4.8 Radiated Emissions in Restricted Bands**

Test Requirement: FCC Part 15 C section 15.247  
(d) In addition, radiated emissions which fall in the restricted bands, as defined in Section 15.205(a), must also comply with the radiated emission limits specified in Section 15.209(a) (see Section 15.205(c)).

Test Method: ANSI C63.10: Clause 11.12.1, 6.4, 6.5 and 6.6

**TEST REPORT**

Test Status: Pre-Scan has been conducted to determine the worst-case mode from all possible combinations between available modulations, data rates and antenna ports (if EUT with antenna diversity architecture). Following channel(s) was (were) selected for the final test as listed below.

Test site: Measurement Distance: 3m (Semi-Anechoic Chamber)

Limit: 40.0 dB $\mu$ V/m between 30MHz & 88MHz;  
43.5 dB $\mu$ V/m between 88MHz & 216MHz;  
46.0 dB $\mu$ V/m between 216MHz & 960MHz;  
54.0 dB $\mu$ V/m above 960MHz.

Detector: For Peak and Quasi-Peak value:  
RBW =  
1 MHz for  $f \geq 1$  GHz,  
200 Hz for 9 kHz to 150 kHz  
9 kHz for 150 kHz to 30 MHz  
120 kHz for 30 MHz to 1GHz  
VBW  $\geq$  RBW  
Sweep = auto  
Detector function = peak for  $f \geq 1$  GHz, QP for  $f < 1$  GHz  
Trace = max hold

For AV value:  
RBW = 1 MHz for  $f \geq 1$  GHz, 100 kHz for  $f < 1$  GHz  
VBW=10 Hz  
Sweep = auto  
Trace = max hold

Field Strength Calculation:

The field strength is calculated by adding the reading on the Spectrum Analyzer to the factors associated with preamplifiers (if any), antennas, cables, pulse desensitization and average factors (when specified limit is in average and measurements are made with peak detectors). A sample calculation is included below:

$$FS = RA + AF + CF - AG + PD + AV$$

$$FS = RA + \text{Correct Factor} + AV$$

Where: FS = Field Strength in dB $\mu$ V/m

RA = Receiver Amplitude (including preamplifier) in dB $\mu$ V

AF = Antenna Factor in dB

CF = Cable Attenuation Factor in dB

AG = Amplifier Gain in dB

PD = Pulse Desensitization in dB

AV = Average Factor in -dB

Correct Factor = AF + CF - AG + PD

In the radiated emission table which follows, the reading shown on the data table may reflect the preamplifier gain. An example of the calculations, where the reading does not reflect the preamplifier gain, follows:

**TEST REPORT**

$$FS = RA + AF + CF - AG + PD + AV$$

Assume a receiver reading of 62.0 dBμV is obtained. The antenna factor of 7.4 dB and cable factor of 1.6 dB is added. The amplifier gain of 29 dB is subtracted. The pulse desensitization factor of the spectrum analyzer was 0 dB, and the resultant average factor was -10 dB. The net field strength for comparison to the appropriate emission limit is 32 dBμV/m.

$$RA = 62.0 \text{ dB}\mu\text{V}$$

$$AF = 7.4 \text{ dB}$$

$$CF = 1.6 \text{ dB}$$

$$AG = 29.0 \text{ dB}$$

$$PD = 0 \text{ dB}$$

$$AV = -10 \text{ dB}$$

$$\text{Correct Factor} = 7.4 + 1.6 - 29.0 + 0 = -20 \text{ dB}$$

$$FS = 62 + (-20) + (-10) = 32 \text{ dB}\mu\text{V/m}$$

Section 15.205 Restricted bands of operation.

(a) Except as shown in paragraph (d) of this section. Only spurious emissions are permitted in any of the frequency bands listed below:

| MHz                 | MHz                 | MHz             | GHz           |
|---------------------|---------------------|-----------------|---------------|
| 0.090 - 0.110       | 16.42 - 16.423      | 399.9 - 410     | 4.5 - 5.15    |
| 10.495 - 0.505      | 16.69475 - 16.69525 | 608 - 614       | 5.35 - 5.46   |
| 2.1735 - 2.1905     | 16.80425 - 16.80475 | 960 - 1240      | 7.25 - 7.75   |
| 4.125 - 4.128       | 25.5 - 25.67        | 1300 - 1427     | 8.025 - 8.5   |
| 4.17725 - 4.17775   | 37.5 - 38.25        | 1435 - 1626.5   | 9.0 - 9.2     |
| 4.20725 - 4.20775   | 73 - 74.6           | 1645.5 - 1646.5 | 9.3 - 9.5     |
| 6.215 - 6.218       | 74.8 - 75.2         | 1660 - 1710     | 10.6 - 12.7   |
| 6.26775 - 6.26825   | 108 - 121.94        | 1718.8 - 1722.2 | 13.25 - 13.4  |
| 6.31175 - 6.31225   | 123 - 138           | 2200 - 2300     | 14.47 - 14.5  |
| 8.291 - 8.294       | 149.9 - 150.05      | 2310 - 2390     | 15.35 - 16.2  |
| 8.362 - 8.366       | 156.52475 -         | 2483.5 - 2500   | 17.7 - 21.4   |
| 8.37625 - 8.38675   | 156.52525           | 2655 - 2900     | 22.01 - 23.12 |
| 8.41425 - 8.41475   | 156.7 - 156.9       | 3260 - 3267     | 23.6 - 24.0   |
| 12.29 - 12.293      | 162.0125 - 167.17   | 3332 - 3339     | 31.2 - 31.8   |
| 12.51975 - 12.52025 | 167.72 - 173.2      | 3345.8 - 3358   | 36.43 - 36.5  |
| 12.57675 - 12.57725 | 240 - 285           | 3600 - 4400     |               |
| 13.36 - 13.41       | 322 - 335.4         |                 |               |

Test Configuration:

- 1) 30 MHz to 1 GHz emissions:

**TEST REPORT**

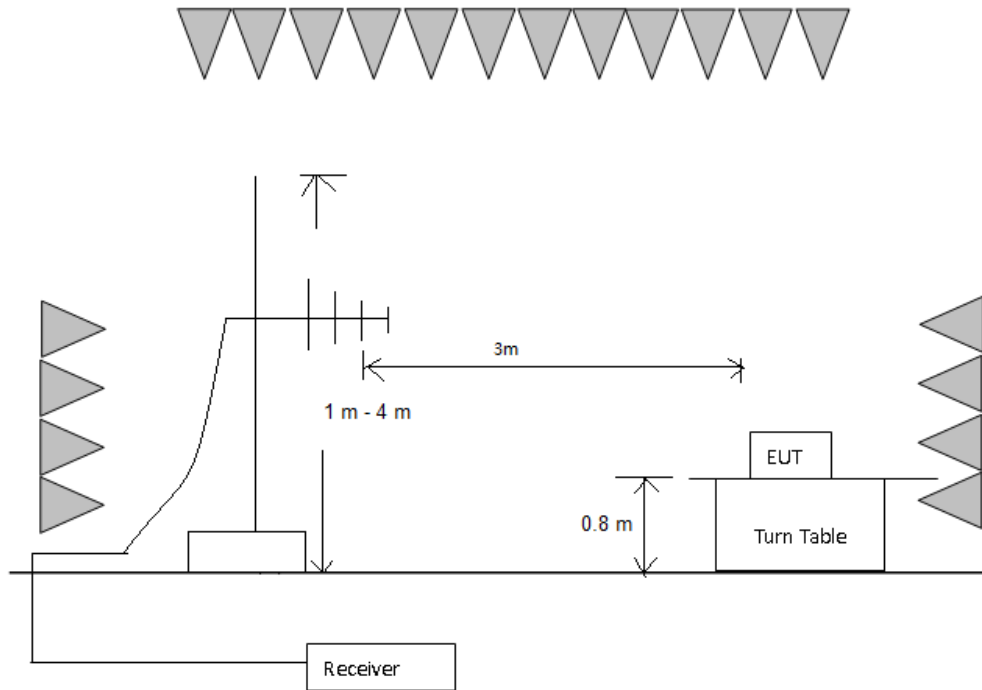

2) 1 GHz to 40 GHz emissions:

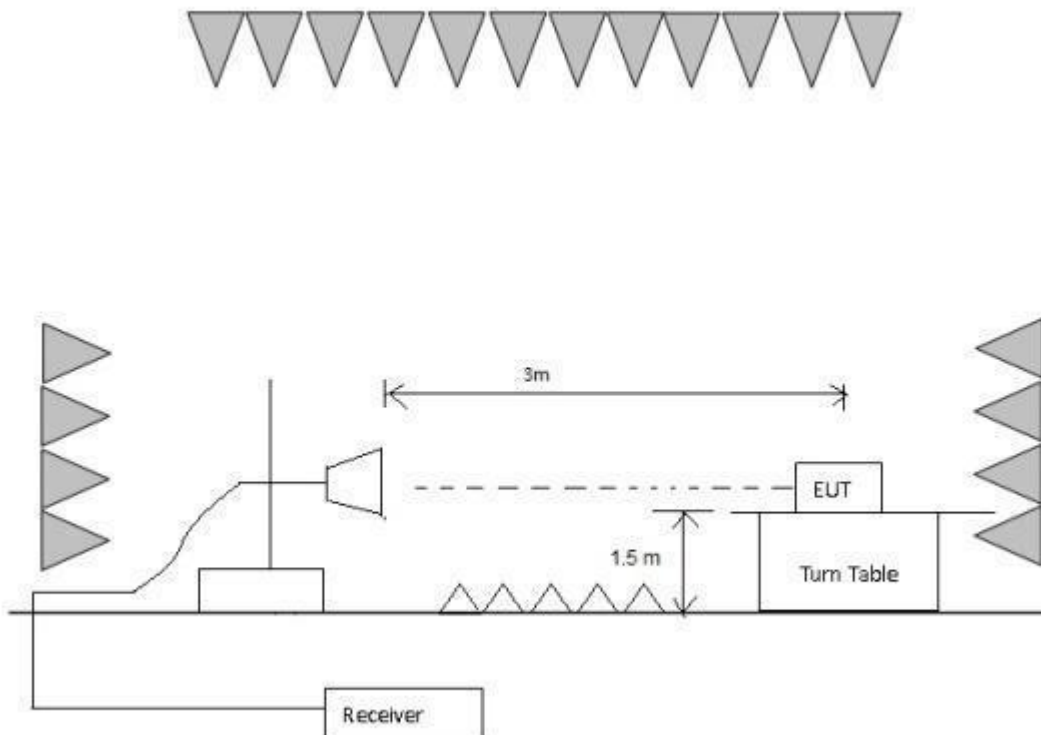

**Test Procedure:**

Test site with RF absorbing material covering the ground plane that met the site validation criterion called out in CISPR 16-1-4:2010 was used to perform radiated emission test above 1 GHz.



**TEST REPORT**

The receiver was scanned from 9 kHz to 25 GHz. When an emission was found, the table was rotated to produce the maximum signal strength. An initial pre-scan was performed for in peak detection mode using the receiver. The EUT was measured for both the Horizontal and Vertical polarities and performed a pre-test three orthogonal planes. For intentional radiators, measurements of the variation of the input power or the radiated signal level of the fundamental frequency component of the emission, as appropriate, shall be performed with the supply voltage varied between 85% and 115% of the nominal rated supply voltage. The worst case emissions were reported.

**Used Test Equipment List:**

3m Semi-Anechoic Chamber, EMI Test Receiver (9 kHz~7 GHz), Signal and Spectrum Analyzer (10 Hz~40 GHz), Loop antenna (9 kHz-30 MHz). TRILOG Super Broadband test Antenna(30 MHz-3 GHz) (RX), Double-Ridged Waveguide Horn Antenna (800 MHz-18 GHz)(RX) and High Frequency Antenna & preamplifier(18 GHz~26.5 GHz) (RX). Refer to Clause 5 Test Equipment List for details.

**9 kHz~30 MHz Field Strength of Unwanted Emissions. Quasi-Peak Measurement**

The measurements with active loop antenna were greater than 20dB below the limit, so the test data were not recorded in the test report.

**30 MHz~1 GHz Spurious Emissions. Quasi-Peak Measurement**

Pre-scan all modes, worst case as below

802.11b mode with 1Mbps data rate Test at Channel 1 (2.412 GHz) in transmitting status

Vertical:

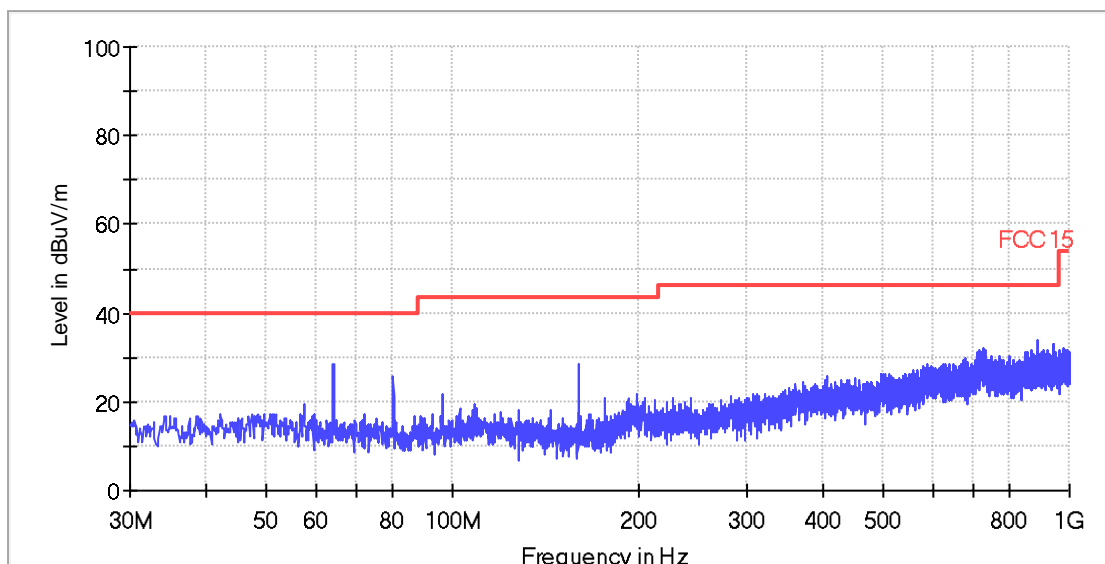

All emission levels are more than 10 dB below the limit.

Horizontal:

**TEST REPORT**

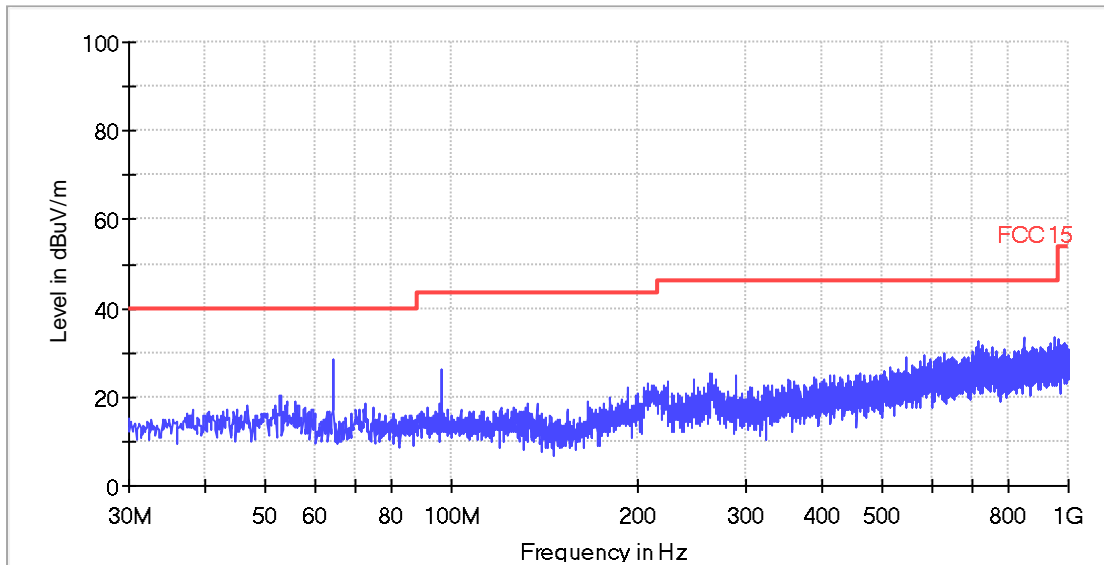

All emission levels are more than 10 dB below the limit.

1~25 GHz Radiated Emissions.

802.11b mode with 1Mbps data rate as below

Test at Channel 1 (2.412 GHz) in transmitting status

**PK Measurement:**

| Frequency<br>(MHz) | PK Reading<br>Level<br>(dBuV) | Correction<br>factors<br>(dB) | PK Emission<br>Level<br>(dBuV/m) | PK Limit<br>(dBuV/m) | Antenna<br>polarization |
|--------------------|-------------------------------|-------------------------------|----------------------------------|----------------------|-------------------------|
| 5974.0             | 41.8                          | 0.6                           | 42.4                             | 74                   | H                       |
| 8041.0             | 40.5                          | 4.0                           | 44.5                             | 74                   | H                       |
| 7096.0             | 40.7                          | 2.1                           | 42.8                             | 74                   | V                       |
| 9037.0             | 40.1                          | 4.5                           | 44.6                             | 74                   | V                       |

Test at Channel 6 (2.437 GHz) in transmitting status

**PK Measurement:**

| Frequency<br>(MHz) | PK Reading<br>Level<br>(dBuV) | Correction<br>factors<br>(dB) | PK Emission<br>Level<br>(dBuV/m) | PK Limit<br>(dBuV/m) | Antenna<br>polarization |
|--------------------|-------------------------------|-------------------------------|----------------------------------|----------------------|-------------------------|
| 7516.0             | 41.5                          | 2.7                           | 44.2                             | 74                   | H                       |
| 9412.0             | 41.8                          | 4.7                           | 46.5                             | 74                   | H                       |
| 6460.0             | 42.9                          | 1.4                           | 44.3                             | 74                   | V                       |
| 8176.0             | 41.9                          | 4.1                           | 46.0                             | 74                   | V                       |

Test at Channel 11 (2.462 GHz) in transmitting status

**TEST REPORT**

**PK Measurement:**

| Frequency | PK Reading Level | Correction factors | PK Emission Level | PK Limit | Antenna polarization |
|-----------|------------------|--------------------|-------------------|----------|----------------------|
| (MHz)     | (dBuV)           | (dB)               | (dBuV/m)          | (dBuV/m) |                      |
| 5323.0    | 42.7             | -0.3               | 42.4              | 74       | H                    |
| 8450.5    | 40.8             | 4.3                | 45.1              | 74       | H                    |
| 7057.0    | 41.5             | 2.1                | 43.6              | 74       | V                    |
| 9508.0    | 40.4             | 4.7                | 45.1              | 74       | V                    |

Remark:

When Peak emission level was below AV limit, the AV emission level did not be recorded.

802.11g mode with 6Mbps data rate as below

Test at Channel 1 (2.412 GHz) in transmitting status

**PK Measurement:**

| Frequency | PK Reading Level | Correction factors | PK Emission Level | PK Limit | Antenna polarization |
|-----------|------------------|--------------------|-------------------|----------|----------------------|
| (MHz)     | (dBuV)           | (dB)               | (dBuV/m)          | (dBuV/m) |                      |
| 6377.5    | 42.0             | 1.3                | 43.3              | 74       | H                    |
| 9071.5    | 41.4             | 4.6                | 46.0              | 74       | H                    |
| 7163.5    | 41.3             | 2.2                | 43.5              | 74       | V                    |
| 8605.0    | 40.9             | 4.4                | 45.3              | 74       | V                    |

Test at Channel 6 (2.437 GHz) in transmitting status

**PK Measurement:**

| Frequency | PK Reading Level | Correction factors | PK Emission Level | PK Limit | Antenna polarization |
|-----------|------------------|--------------------|-------------------|----------|----------------------|
| (MHz)     | (dBuV)           | (dB)               | (dBuV/m)          | (dBuV/m) |                      |
| 5150.5    | 42.1             | -0.6               | 41.5              | 74       | H                    |
| 9380.5    | 42.0             | 4.7                | 46.7              | 74       | H                    |
| 6487.0    | 42.4             | 1.4                | 43.8              | 74       | V                    |
| 9278.5    | 40.0             | 4.6                | 44.6              | 74       | V                    |

Test at Channel 11 (2.462 GHz) in transmitting status

**PK Measurement:**

| Frequency | PK Reading Level | Correction factors | PK Emission Level | PK Limit | Antenna polarization |
|-----------|------------------|--------------------|-------------------|----------|----------------------|
| (MHz)     | (dBuV)           | (dB)               | (dBuV/m)          | (dBuV/m) |                      |
| 5006.5    | 42.5             | -0.8               | 41.7              | 74       | H                    |
| 8398.0    | 41.3             | 4.3                | 45.6              | 74       | H                    |
| 6082.0    | 41.1             | 0.8                | 41.9              | 74       | V                    |
| 9574.0    | 41.2             | 5.0                | 46.2              | 74       | V                    |

**TEST REPORT**

Remark:

When Peak emission level was below AV limit, the AV emission level did not be recorded.

802.11n20 mode with 6.5Mbps data rate as below

Test at Channel 1 (2.412 GHz) in transmitting status

**PK Measurement:**

| Frequency<br>(MHz) | PK Reading<br>Level<br>(dBuV) | Correction<br>factors<br>(dB) | PK Emission<br>Level<br>(dBuV/m) | PK Limit<br>(dBuV/m) | Antenna<br>polarization |
|--------------------|-------------------------------|-------------------------------|----------------------------------|----------------------|-------------------------|
| 6403.0             | 41.7                          | 1.3                           | 43.0                             | 74                   | H                       |
| 7922.5             | 40.8                          | 3.8                           | 44.6                             | 74                   | H                       |
| 6752.5             | 42.5                          | 1.7                           | 44.2                             | 74                   | V                       |
| 9497.5             | 42.9                          | 4.7                           | 47.6                             | 74                   | V                       |

Test at Channel 6 (2.437 GHz) in transmitting status

**PK Measurement:**

| Frequency<br>(MHz) | PK Reading<br>Level<br>(dBuV) | Correction<br>factors<br>(dB) | PK Emission<br>Level<br>(dBuV/m) | PK Limit<br>(dBuV/m) | Antenna<br>polarization |
|--------------------|-------------------------------|-------------------------------|----------------------------------|----------------------|-------------------------|
| 5272.0             | 42.6                          | -0.4                          | 42.2                             | 74                   | H                       |
| 8341.0             | 41.4                          | 4.2                           | 45.6                             | 74                   | H                       |
| 7213.0             | 41.7                          | 2.3                           | 44.0                             | 74                   | V                       |
| 9377.5             | 42.4                          | 4.7                           | 47.1                             | 74                   | V                       |

Test at Channel 11 (2.462 GHz) in transmitting status

**PK Measurement:**

| Frequency<br>(MHz) | PK Reading<br>Level<br>(dBuV) | Correction<br>factors<br>(dB) | PK Emission<br>Level<br>(dBuV/m) | PK Limit<br>(dBuV/m) | Antenna<br>polarization |
|--------------------|-------------------------------|-------------------------------|----------------------------------|----------------------|-------------------------|
| 6320.5             | 40.8                          | 1.2                           | 42.0                             | 74                   | H                       |
| 8554.0             | 39.5                          | 4.4                           | 43.9                             | 74                   | H                       |
| 7079.5             | 41.9                          | 2.1                           | 44.0                             | 74                   | V                       |
| 8390.5             | 40.7                          | 4.3                           | 45.0                             | 74                   | V                       |

Remark:

When Peak emission level was below AV limit, the AV emission level did not be recorded.

**Band Edges Emission**

802.11b mode with 1Mbps data rate

Test at Channel 1 (2.412 GHz) in transmitting status

**TEST REPORT**

Horizontal

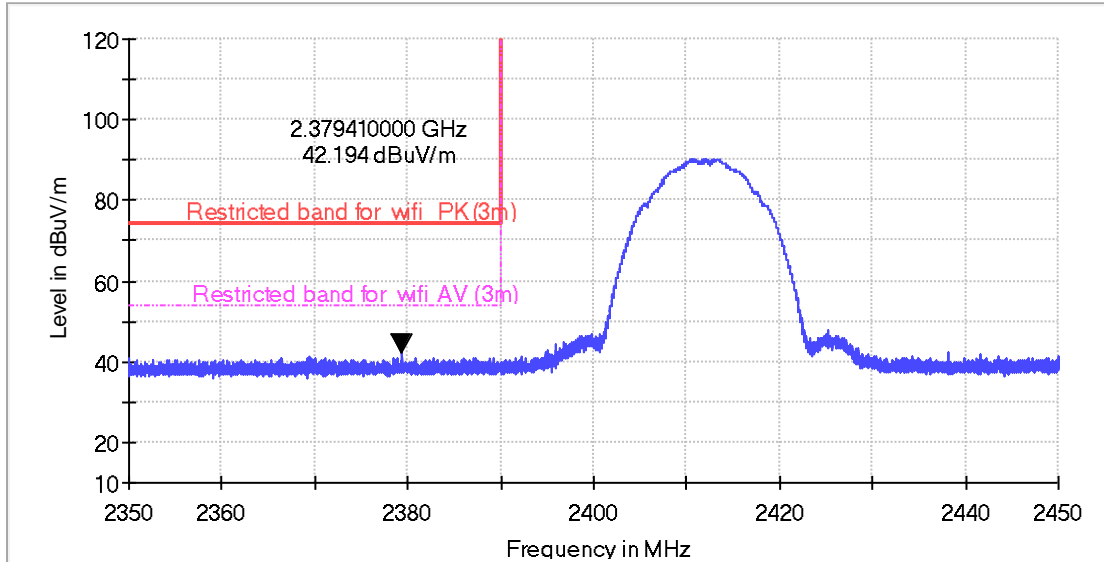

Vertical

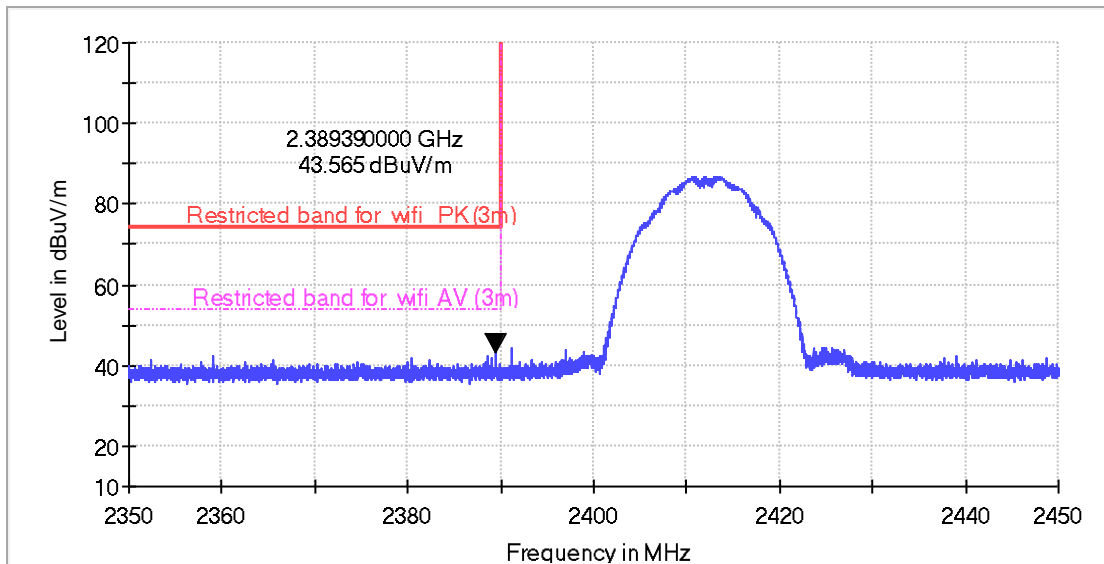

**PK Measurement:**

| Frequency | PK Reading Level | Correction factors | PK Emission Level | PK Limit | Antenna polarization |
|-----------|------------------|--------------------|-------------------|----------|----------------------|
| (MHz)     | (dBuV)           | (dB)               | (dBuV/m)          | (dBuV/m) |                      |
| 2379.4    | 50.4             | -8.2               | 42.2              | 74       | H                    |
| 2389.4    | 51.8             | -8.2               | 43.6              | 74       | V                    |

## TEST REPORT

Remark: When Peak emission level was below AV limit, the AV emission level did not be recorded.

Test at Channel 11 (2.462 GHz) in transmitting status

Horizontal

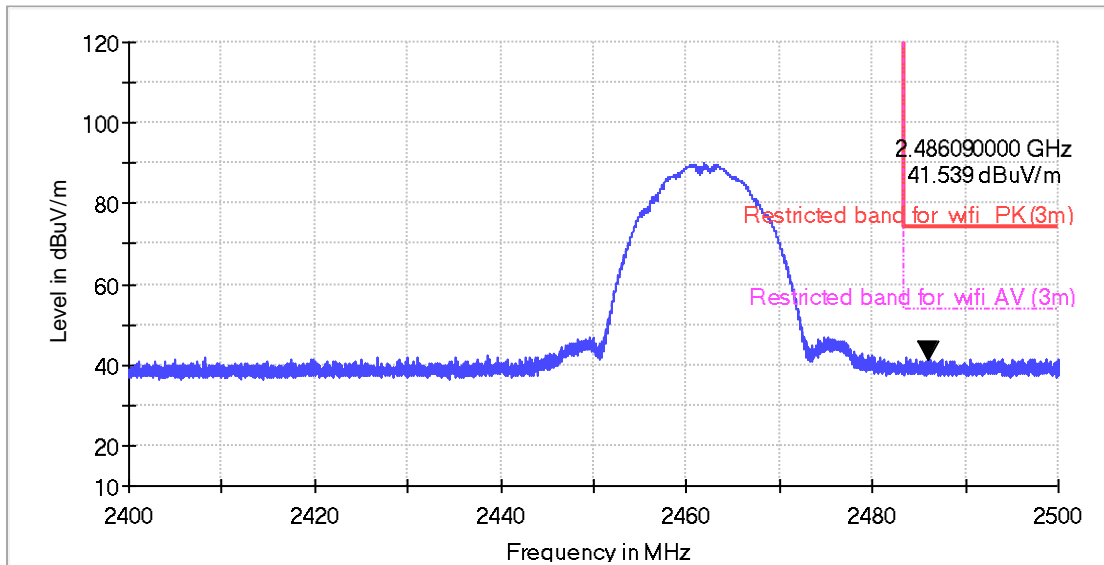

Vertical

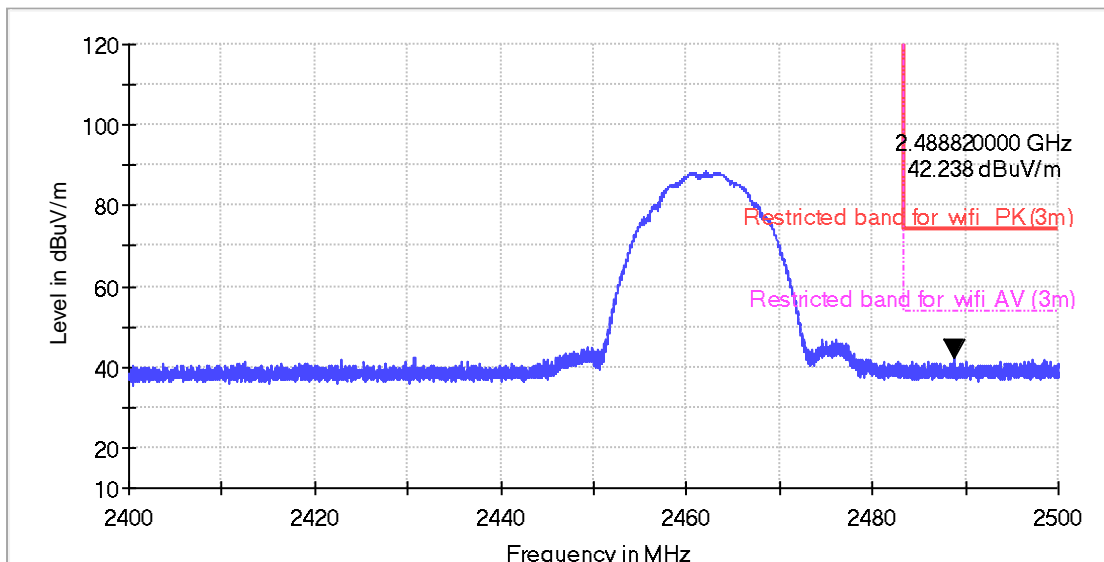

### PK Measurement:

| Frequency | PK Reading | Correction | PK Emission | PK Limit | Antenna |
|-----------|------------|------------|-------------|----------|---------|
|-----------|------------|------------|-------------|----------|---------|

**TEST REPORT**

|        | Level  | factors | Level    |          | polarization |
|--------|--------|---------|----------|----------|--------------|
| (MHz)  | (dBuV) | (dB)    | (dBuV/m) | (dBuV/m) |              |
| 2486.1 | 49.3   | -7.8    | 41.5     | 74       | H            |
| 2488.8 | 50.0   | -7.8    | 42.2     | 74       | V            |

802.11g mode with 6Mbps data rate  
Test at Channel 1 (2.412 GHz) in transmitting status

Horizontal

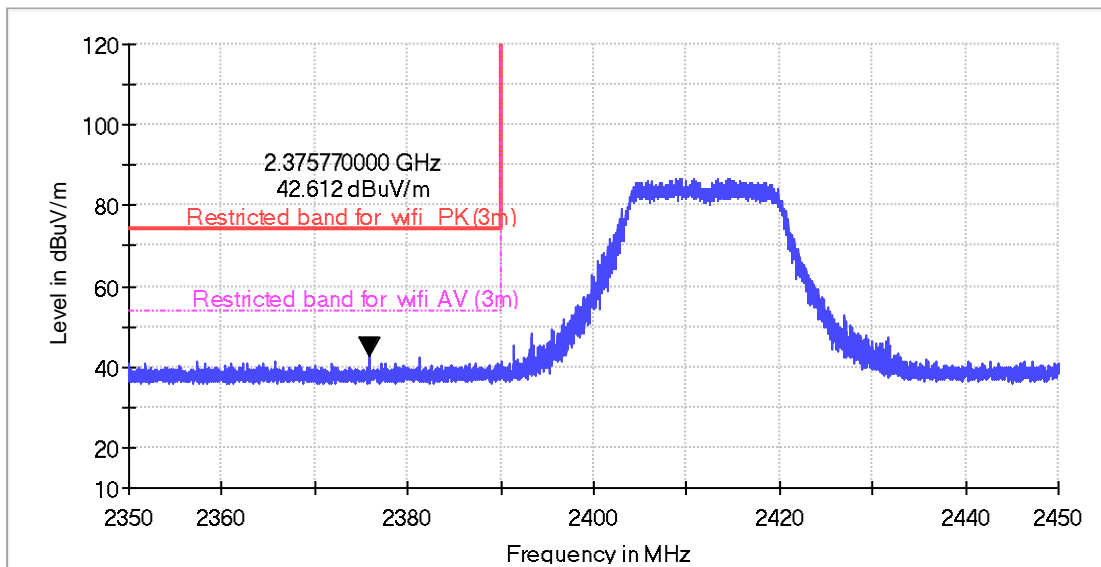

Vertical

## TEST REPORT

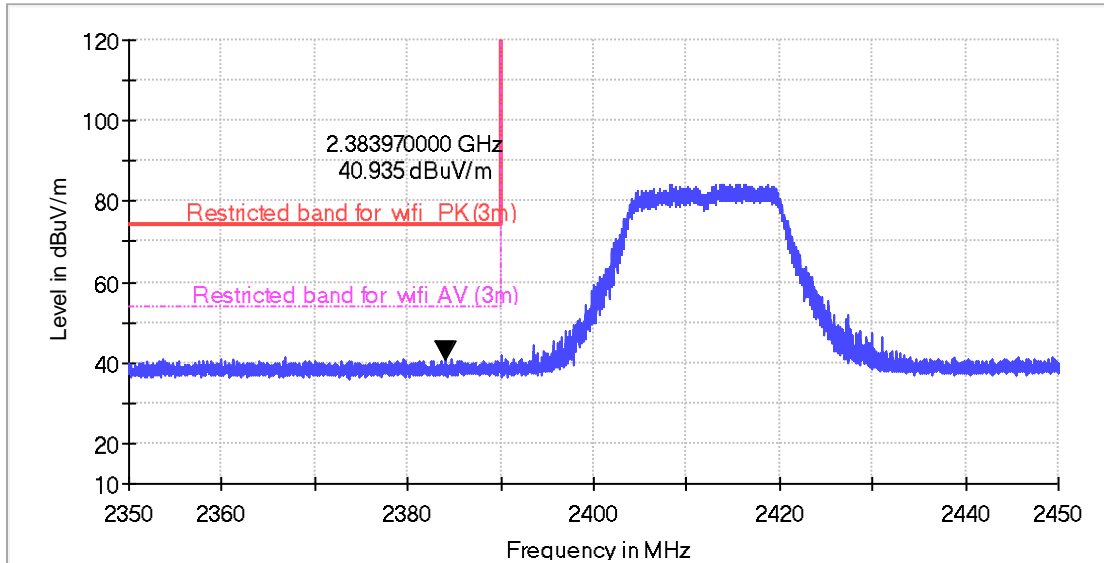

### PK Measurement:

| Frequency<br>(MHz) | PK Reading<br>Level<br>(dBuV) | Correction<br>factors<br>(dB) | PK Emission<br>Level<br>(dBuV/m) | PK Limit<br>(dBuV/m) | Antenna<br>polarization |
|--------------------|-------------------------------|-------------------------------|----------------------------------|----------------------|-------------------------|
| 2375.8             | 50.8                          | -8.2                          | 42.6                             | 74                   | H                       |
| 2384.0             | 49.1                          | -8.2                          | 40.9                             | 74                   | V                       |

Test at Channel 11 (2.462 GHz) in transmitting status  
Horizontal

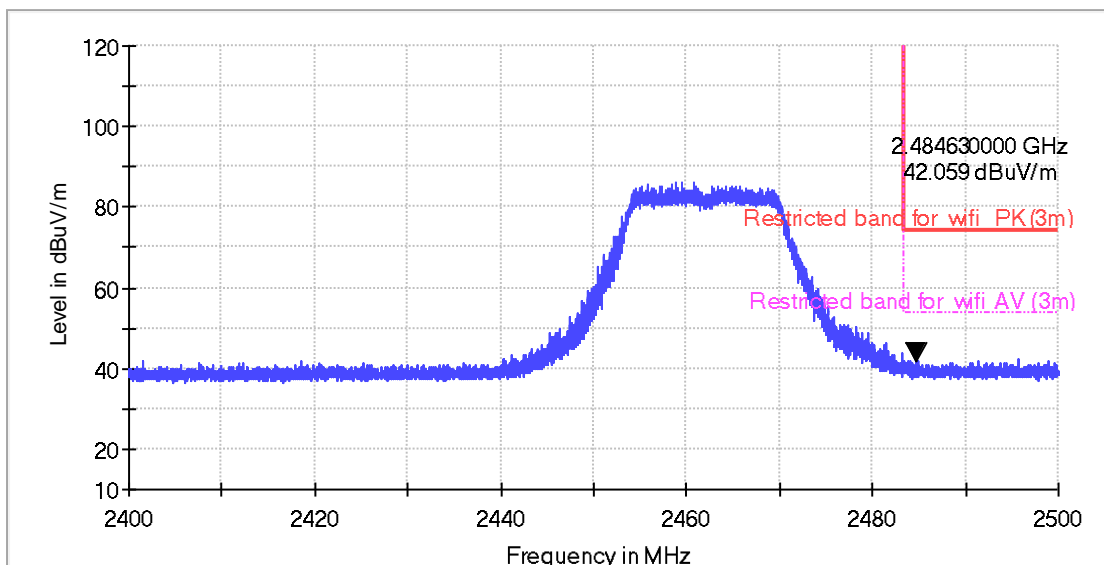

Vertical



**TEST REPORT**

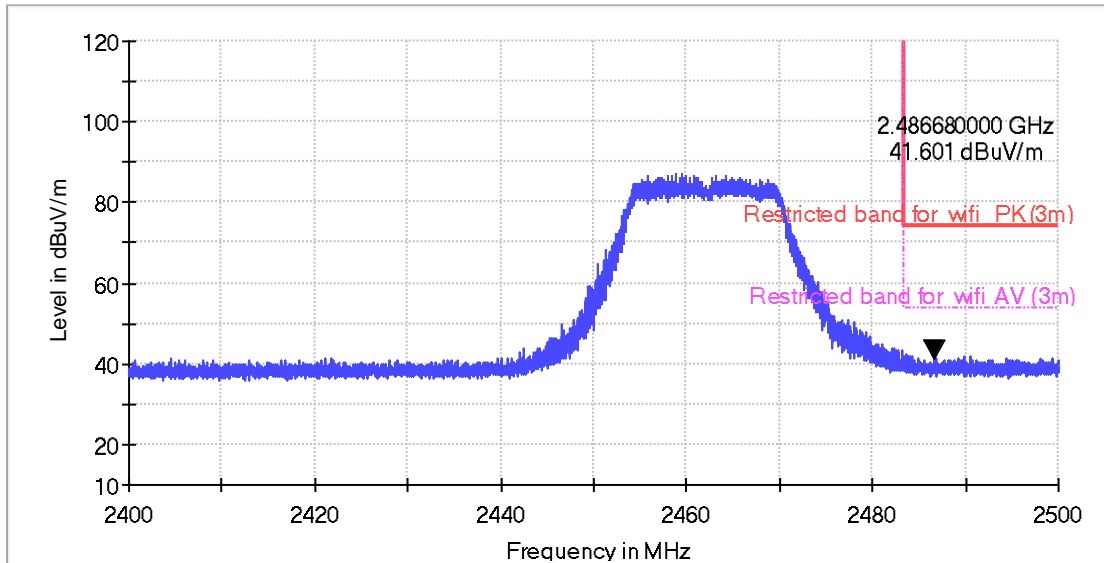

**PK Measurement:**

| Frequency<br>(MHz) | PK Reading<br>Level<br>(dBuV) | Correction<br>factors<br>(dB) | PK Emission<br>Level<br>(dBuV/m) | PK Limit<br>(dBuV/m) | Antenna<br>polarization |
|--------------------|-------------------------------|-------------------------------|----------------------------------|----------------------|-------------------------|
| 2484.6             | 49.9                          | -7.8                          | 42.1                             | 74                   | H                       |
| 2486.7             | 49.4                          | -7.8                          | 41.6                             | 74                   | V                       |

Remark: When Peak emission level was below AV limit, the AV emission level did not be recorded.

802.11n (HT20) mode with 6.5Mbps data rate  
Test at Channel 1 (2.412 GHz) in transmitting status  
Horizontal

**TEST REPORT**

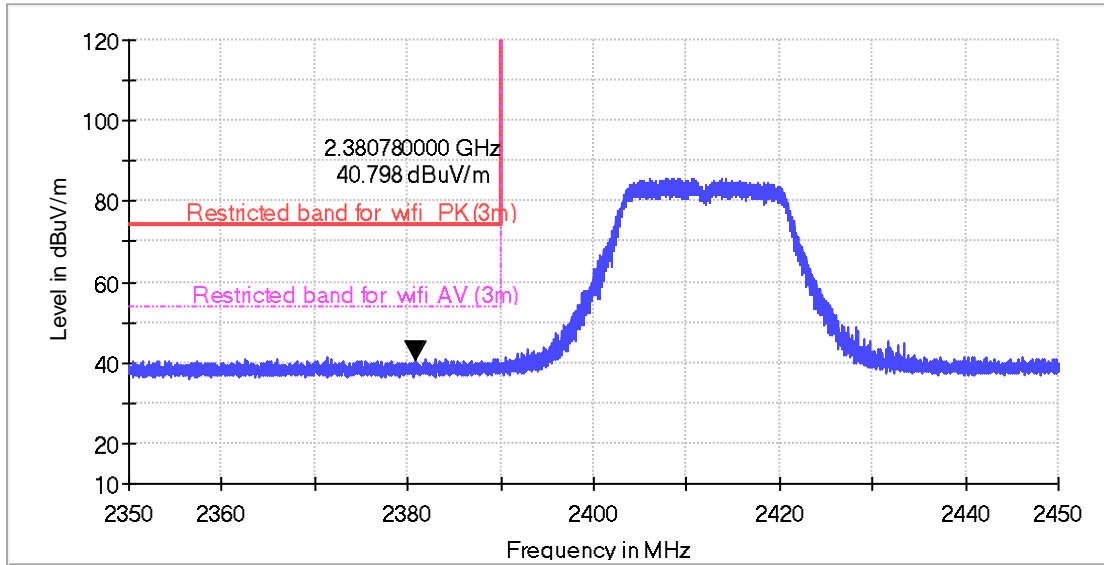

Vertical

**TEST REPORT**

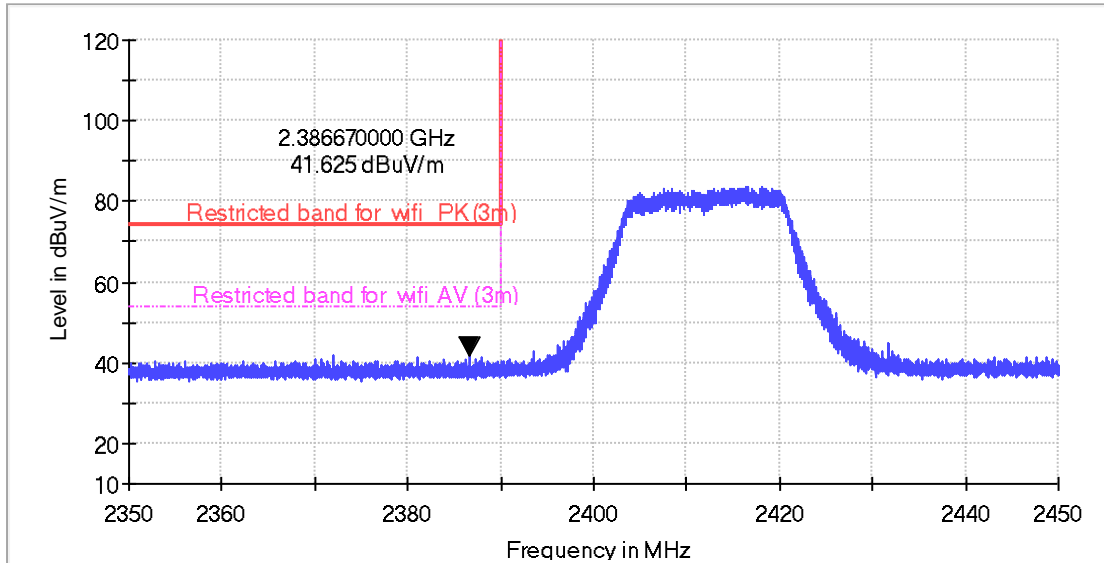

**PK Measurement:**

| Frequency<br>(MHz) | PK Reading<br>Level<br>(dBuV) | Correction<br>factors<br>(dB) | PK Emission<br>Level<br>(dBuV/m) | PK Limit<br>(dBuV/m) | Antenna<br>polarization |
|--------------------|-------------------------------|-------------------------------|----------------------------------|----------------------|-------------------------|
| 2380.8             | 49.0                          | -8.2                          | 40.8                             | 74                   | H                       |
| 2386.7             | 49.8                          | -8.2                          | 41.6                             | 74                   | V                       |

Remark: When Peak emission level was below AV limit, the AV emission level did not be recorded.

Test at Channel 11 (2.462 GHz) in transmitting status  
Horizontal

**TEST REPORT**

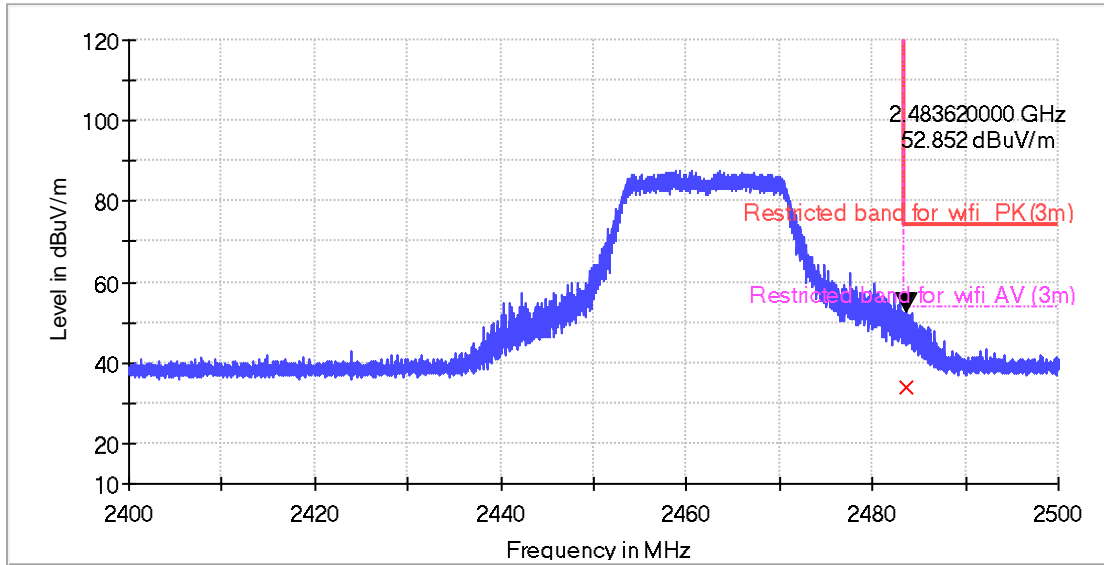

Vertical

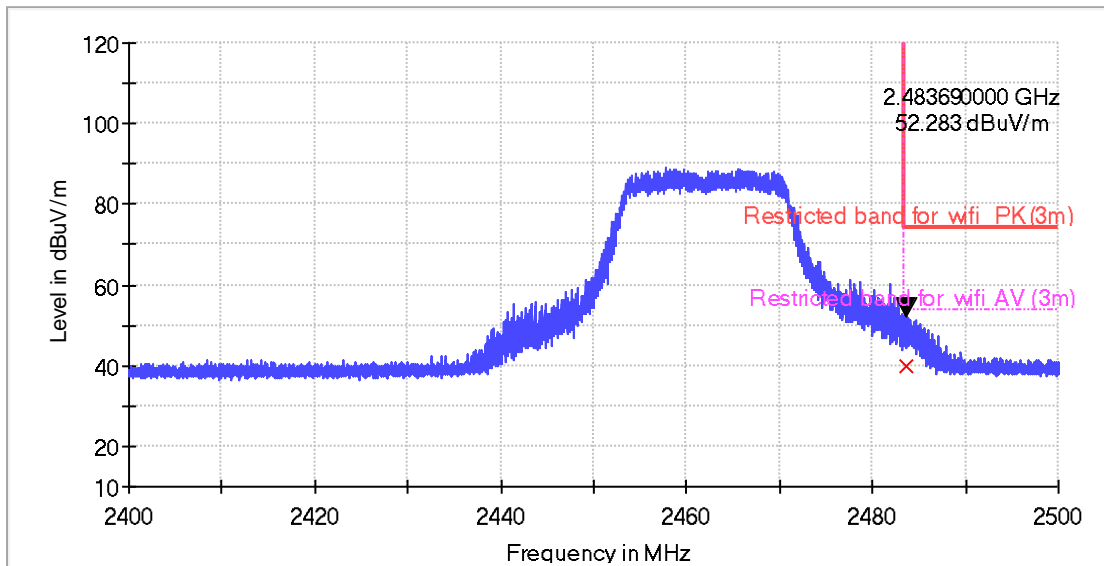

**PK Measurement:**

| Frequency<br>(MHz) | PK Reading<br>Level<br>(dBuV) | Correction<br>factors<br>(dB) | PK Emission<br>Level<br>(dBuV/m) | PK Limit<br>(dBuV/m) | Antenna<br>polarization |
|--------------------|-------------------------------|-------------------------------|----------------------------------|----------------------|-------------------------|
| 2483.6             | 60.7                          | -7.8                          | 52.9                             | 74                   | H                       |
| 2483.7             | 60.1                          | -7.8                          | 52.3                             | 74                   | V                       |

**TEST REPORT**

**AV Measurement:**

| Frequency | Reading Level | Correction factors | AV Emission Level | AV Limit | Antenna polarization |
|-----------|---------------|--------------------|-------------------|----------|----------------------|
| (MHz)     | (dBuV)        | (dB)               | (dBuV/m)          | (dBuV/m) |                      |
| 2483.6    | 41.7          | -7.8               | 33.9              | 54       | H                    |
| 2483.7    | 47.7          | -7.8               | 39.9              | 54       | V                    |

Remark: When Peak emission level was below AV limit, the AV emission level did not be recorded.

For all emission(above 1G)

Final Test Level =Receiver Reading + Correction Factor

Correction Factor = Antenna Factor + Cable Loss –Preamplifier Factor.

When Peak emission level was below AV limit, the AV emission level did not be recorded.

**TEST REPORT**

**4.9 Band Edges Requirement**

Test Requirement: FCC Part 15 C section 15.247  
(d) In any 100 kHz bandwidth outside the frequency band in which the spread spectrum or digitally modulated intentional radiator is operating. The radio frequency power that is produced by the intentional radiator shall be at least 20 dB below that in the 100 kHz bandwidth within the band that contains the highest level of the desired power. Based on either an RF conducted or a radiated measurement. Provided the transmitter demonstrates compliance with the peak conducted power limits. If the transmitter complies with the conducted power limits based on the use of RMS averaging over a time interval, as permitted under paragraph (b)(3) of this section, the attenuation required under this paragraph shall be 30dB instead of 20dB.

Frequency Band: 2400 MHz to 2483.5 MHz

Test Method: ANSI C63.10: Clause 11.11 and 11.13

Test Status: Pre-Scan has been conducted to determine the worst-case mode from all possible combinations between available modulations, data rates and antenna ports (if EUT with antenna diversity architecture). Following channel(s) was (were) selected for the final test as listed below.

Test Configuration: For Band Edges Emission in Radiated mode, Please refer to clause 4.7

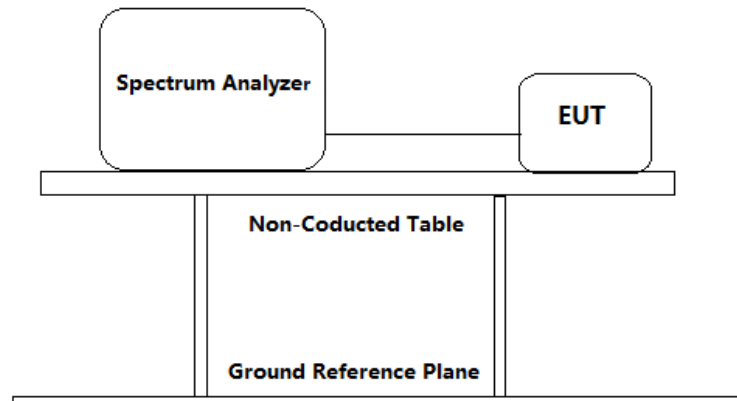

Test Procedure: For Band Edges Emission in Radiated mode, Please refer to clause 4.7

1. Remove the antenna from the EUT and then connect a low RF cable(cable loss =1 dB, with 10dB attenuator) from the antenna port to the spectrum analyzer.
  - a) Set instrument center frequency to the frequency of the emission to be measured (must be within 2 MHz of the authorized band edge).
  - b) Set the center frequency and span to encompass frequency range to be measured.
  - c) RBW = 100 kHz.
  - d) VBW  $\geq$  [3  $\times$  RBW].

## TEST REPORT

- e) Detector = peak.
  - f) Sweep time = auto.
  - g) Trace mode = max hold.
  - h) Allow sweep to continue until the trace stabilizes (required measurement time may increase for low-duty-cycle applications).
  - i) For radiated Band-edge emissions within a restricted band and within 2 MHz of an authorized band edge, integration method is considered.
2. Repeat until all the test status is investigated.
  3. Report the worst case.

### Used Test Equipment List:

3m Semi-Anechoic Chamber, EMI Test Receiver (9 kHz~7 GHz), Signal and Spectrum Analyzer (10 Hz~40 GHz), Loop antenna (9 kHz-30 MHz). TRILOG Super Broadband test Antenna(30 MHz-3 GHz) (RX), Double-Ridged Waveguide Horn Antenna (800 MHz-18 GHz)(RX) and High Frequency Antenna & preamplifier(18 GHz~26.5 GHz) (RX). Refer to Clause 5 Test Equipment List for details.

Test result with plots as follows:

For conduct mode:

The band edges was measured and recorded Result:

The Lower Edges attenuated more than 30dB.

The Upper Edges attenuated more than 30dB.

**TEST REPORT**

**Result plots as follows:**  
**802.11b mode with 1Mbps data rate**  
Channel1: 2.412 GHz

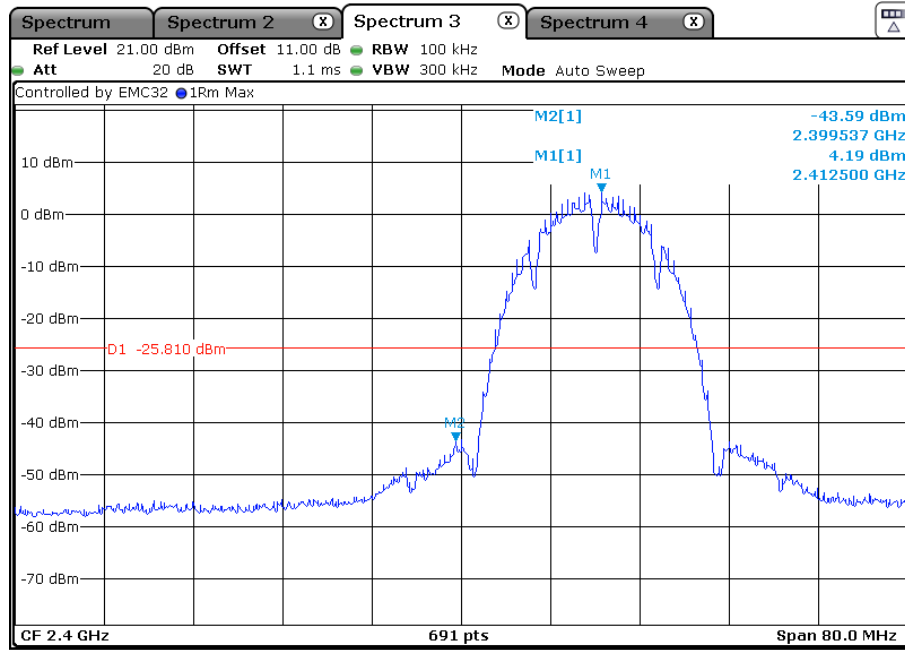

Channel 11: 2.462 GHz

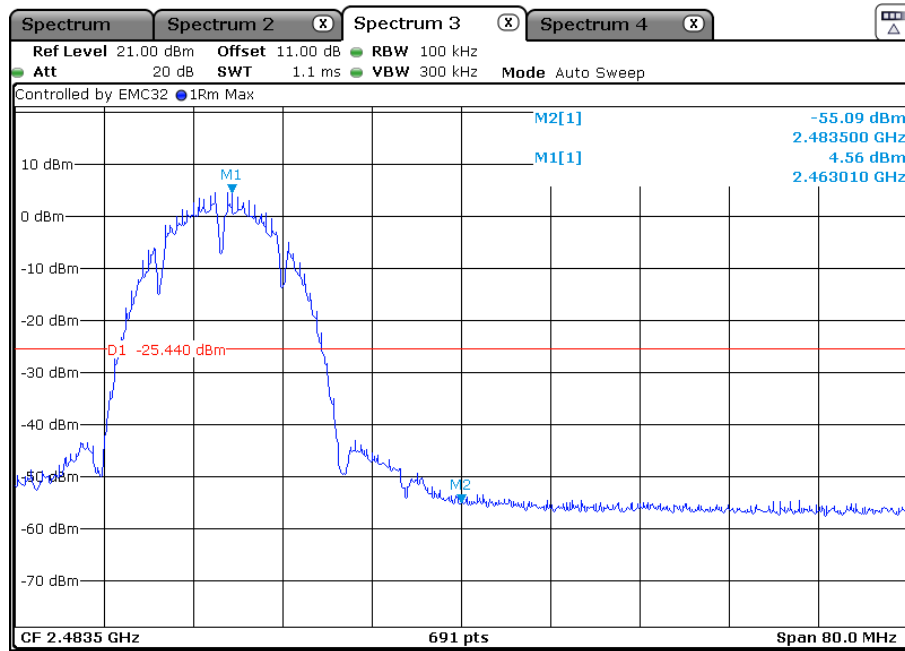



**TEST REPORT**

**802.11g mode with 6 Mbps data rate**

Channel1: 2.412 GHz

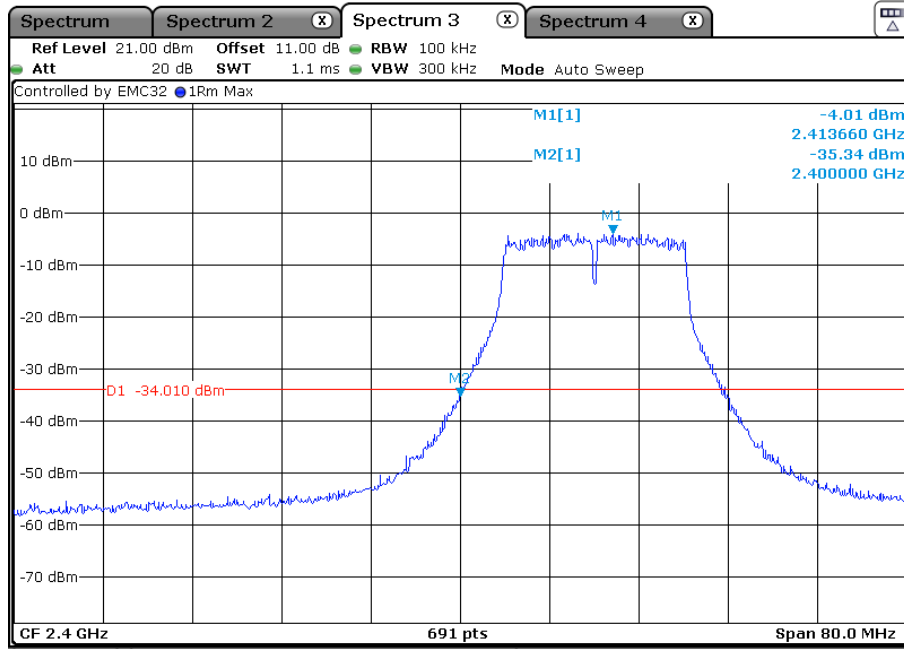

Channel 11: 2.462 GHz

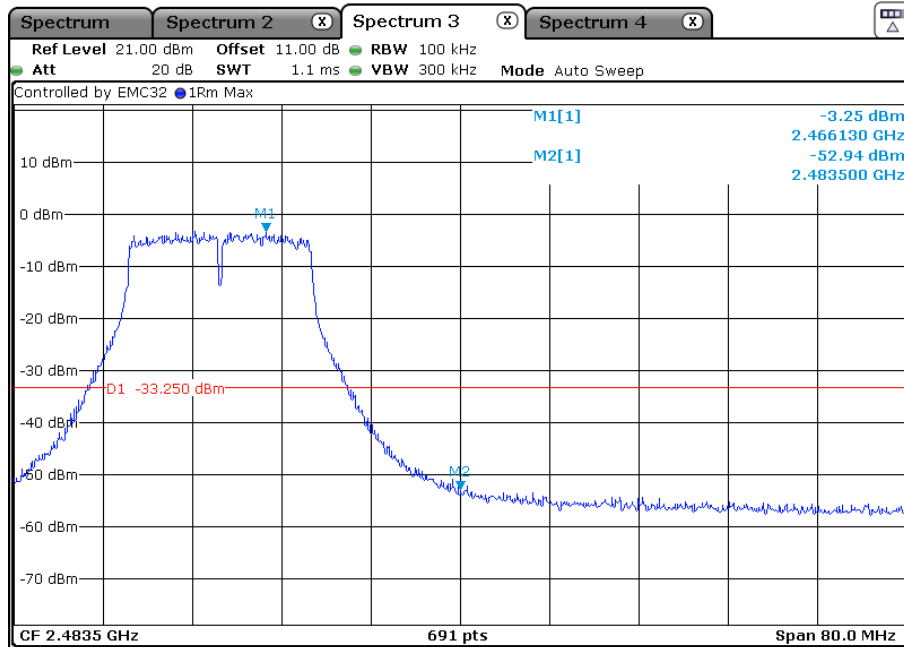

**TEST REPORT**

**802.11n(HT20) mode with 6.5Mbps data rate**

Channel 1: 2.412 GHz

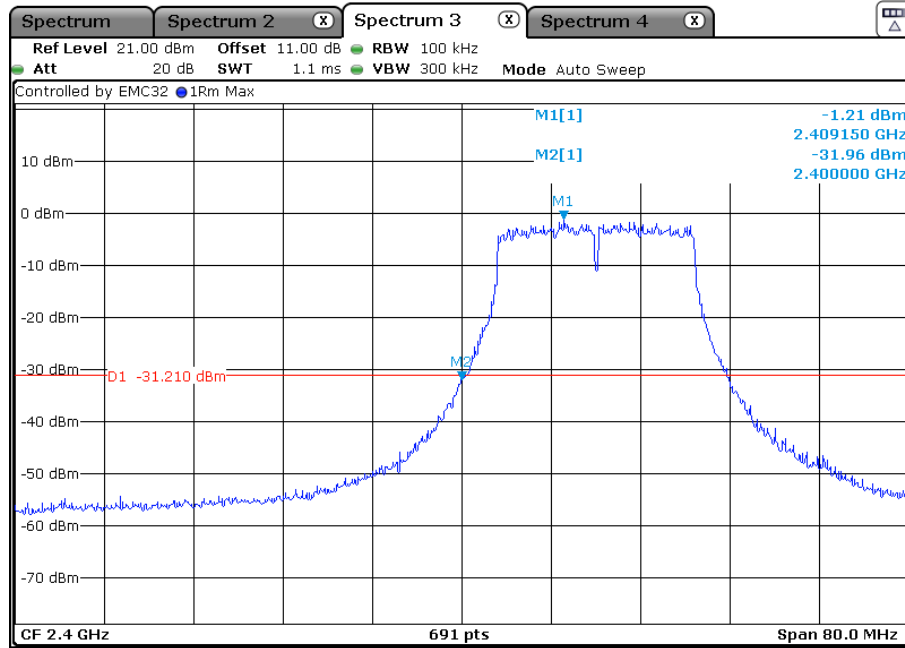

Channel 11: 2.462 GHz

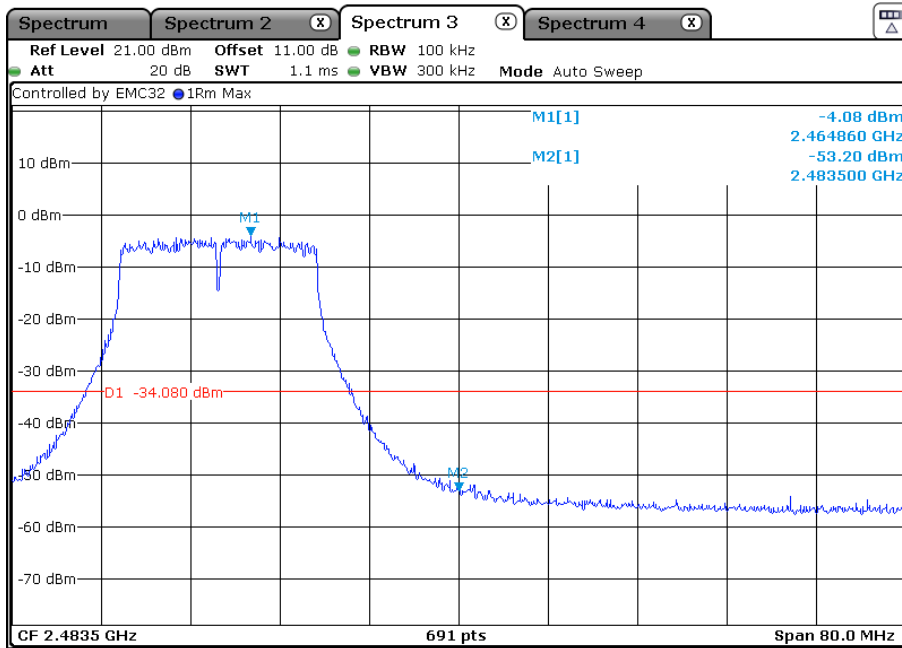

**TEST REPORT**

**4.10 Conducted Emission Test**

Test Configuration:

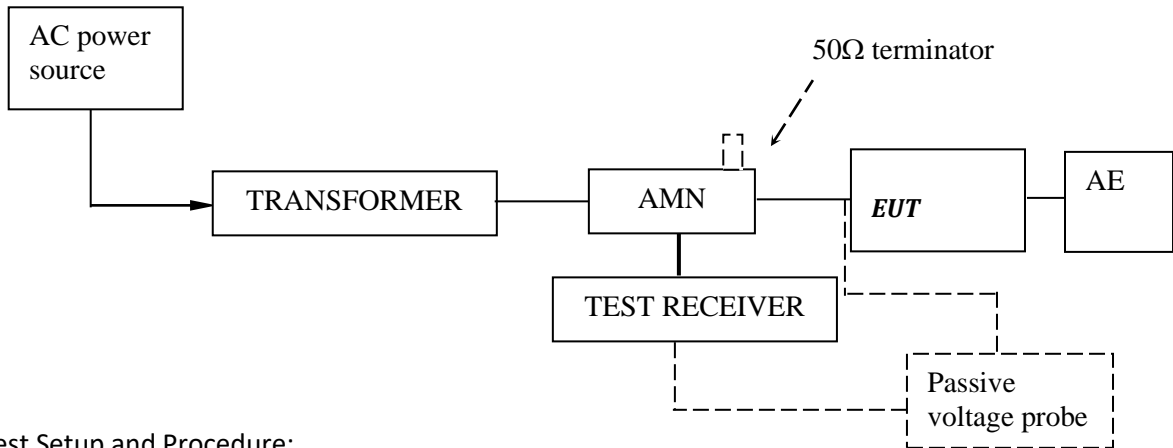

Test Setup and Procedure:

Test was performed according to ANSI C63.10 Clause 6.2. The EUT was set to achieve the maximum emission level. The mains terminal disturbance voltage was measured with the EUT in a shielded room. The EUT was connected to AC power source through an Artificial Mains Network which provides a 50Ω linear impedance. Artificial hand is used if appropriate (for handheld apparatus). The load/control terminal disturbance voltage was measured with passive voltage probe if appropriate.

The table-top EUT was placed on a 0.8m high non-metallic table above earthed ground plane (Ground Reference Plane). And for floor standing EUT, was placed on a 0.1m high non-metallic supported on GRP. The EUT keeps a distance of at least 0.8m from any other of the metallic surface. The Artificial Mains Network is situated at a distance of 0.8m from the EUT.

During the test, mains lead of EUT excess 0.8m was folded back and forth parallel to the lead so as to form a horizontal bundle with a length between 0.3m and 0.4m

The bandwidth of test receiver was set at 9 kHz. The frequency range from 150 kHz to 30MHz was checked.

**TEST REPORT**

Test Data and Curve

At main terminal: Pass

Tested Wire: Live

Operation Mode: transmitting mode

Full Spectrum

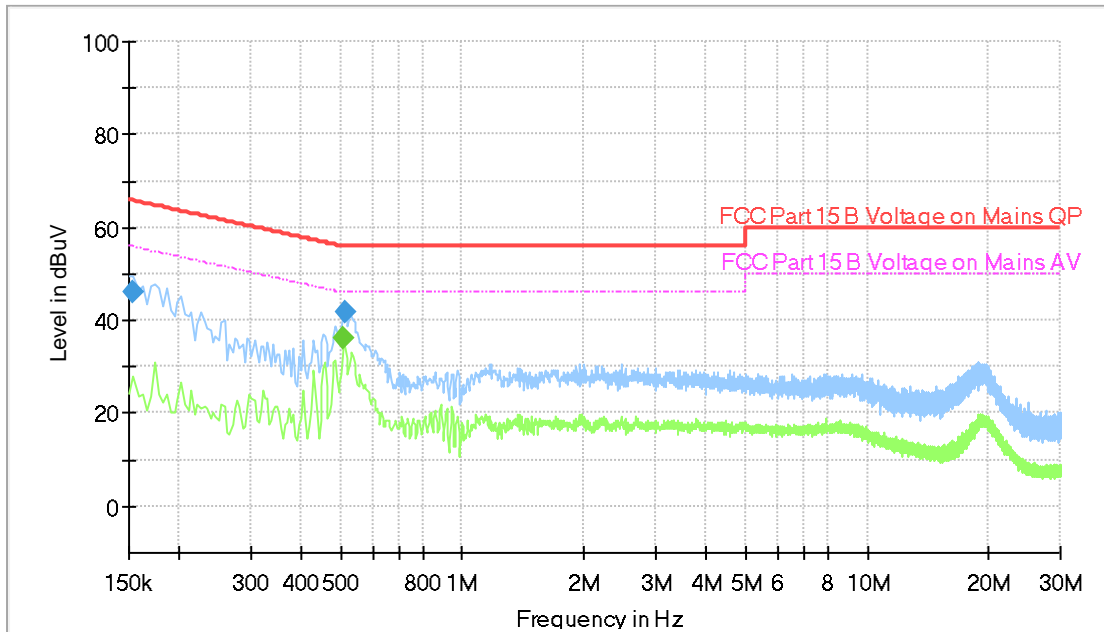

**Final Result**

| Frequency (MHz) | QuasiPeak (dBuV) | CAverage (dBuV) | Limit (dBuV) | Margin (dB) | Meas. Time (ms) | Bandwidth (kHz) | Line | Filter | Corr. (dB) |
|-----------------|------------------|-----------------|--------------|-------------|-----------------|-----------------|------|--------|------------|
| 0.154000        | 45.94            | ---             | 65.78        | 19.84       | 1000.0          | 9.000           | L1   | ON     | 9.7        |
| 0.510000        | ---              | 36.16           | 46.00        | 9.84        | 1000.0          | 9.000           | L1   | ON     | 9.8        |
| 0.514000        | 41.72            | ---             | 56.00        | 14.28       | 1000.0          | 9.000           | L1   | ON     | 9.8        |

Remark:

1. Corr. (dB) = LISN Factor (dB) + Cable Loss (dB)
2. Level (dBμV) = Corr. (dB) + Read Level (dBμV)
3. Delta Limit (dB) = Level (dBμV)-Limit (dBμV)

**TEST REPORT**

Tested Wire: Neutral

Operation Mode: transmitting mode

Full Spectrum

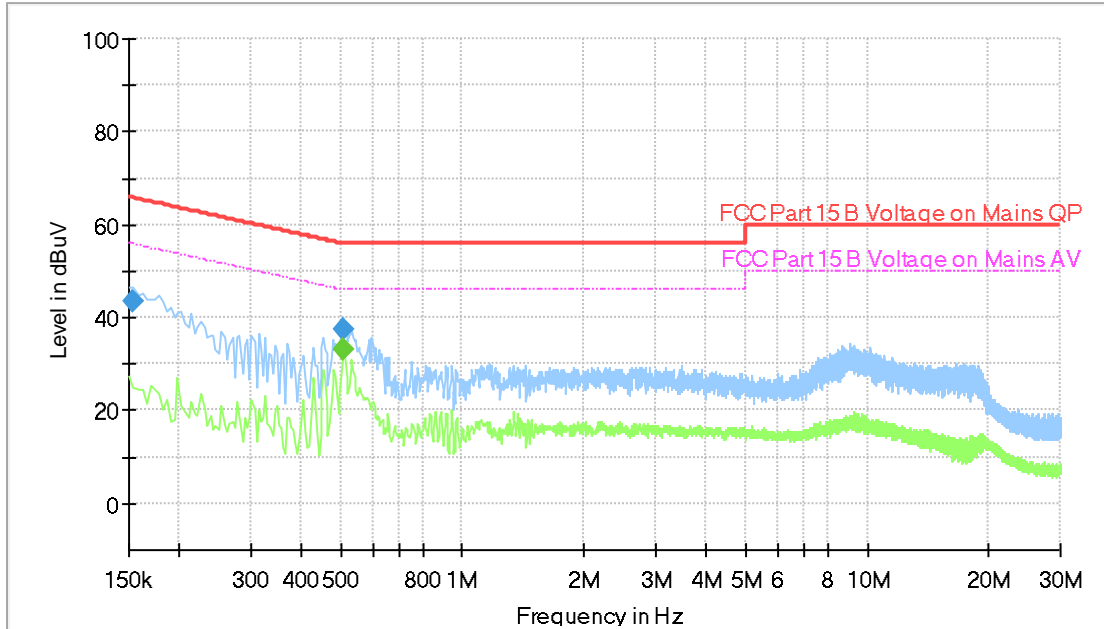

**Final\_Result**

| Frequency (MHz) | QuasiPeak (dBuV) | CAverage (dBuV) | Limit (dBuV) | Margin (dB) | Meas. Time (ms) | Bandwidth (kHz) | Line | Filter | Corr. (dB) |
|-----------------|------------------|-----------------|--------------|-------------|-----------------|-----------------|------|--------|------------|
| 0.154000        | 43.64            | ---             | 65.78        | 22.14       | 1000.0          | 9.000           | N    | ON     | 9.8        |
| 0.506000        | 37.64            | ---             | 56.00        | 18.36       | 1000.0          | 9.000           | N    | ON     | 9.8        |
| 0.510000        | ---              | 33.02           | 46.00        | 12.98       | 1000.0          | 9.000           | N    | ON     | 9.8        |

1. Corr. (dB) = LISN Factor (dB) + Cable Loss (dB)
2. Level (dBμV) = Corr. (dB) + Read Level (dBμV)
3. Delta Limit (dB) = Level (dBμV)-Limit (dBμV)

## TEST REPORT

### 5.0 Test Equipment List

| Radiated Emission/Radio                   |  |                      |               |                               |                         |
|---|--|----------------------|---------------|-------------------------------|-------------------------|
| Equipment No.                             | Equipment  | Model                | Manufacturer  | Cal. Due date<br>(YYYY-MM-DD) | Calibration<br>Interval |
| EM030-04                                  | 3m Semi-Anechoic Chamber                                       | 9×6×6 m <sup>3</sup> | ETS• LINDGREN | 2023-04-07                    | 1Y                      |
| EM031-02                                  | EMI Test Receiver (9 kHz~7 GHz)                                | R&S ESR7             | R&S           | 2023-11-15                    | 1Y                      |
| EM031-03                                  | Signal and Spectrum Analyzer<br>(10 Hz~40 GHz)                 | R&S FSV40            | R&S           | 2023-11-15                    | 1Y                      |
| EM011-04                                  | Loop antenna (9 kHz-30 MHz)                                    | HFH2-Z2              | R&S           | 2023-06-27                    | 1Y                      |
| EM061-03                                  | TRILOG Super Broadband test<br>Antenna (30 MHz-1.5 GHz) (TX)   | VULB 9161            | SCHWARZBECK   | 2023-06-26                    | 1Y                      |
| EM033-01                                  | TRILOG Super Broadband test<br>Antenna(30 MHz-3 GHz) (RX)      | VULB 9163            | SCHWARZBECK   | 2023-10-25                    | 1Y                      |
| EM033-02                                  | Bouble-Ridged Waveguide Horn<br>Antenna (800 MHz-18 GHz)(RX)   | R&S HF907            | R&S           | 2023-06-26                    | 1Y                      |
| EM033-03                                  | High Frequency Antenna &<br>preamplifier(18 GHz~26.5 GHz) (RX) | R&S SCU-26           | R&S           | 2023-04-16                    | 1Y                      |
| EM033-04                                  | High Frequency Antenna &<br>preamplifier (26 GHz-40 GHz)       | R&S SCU-40           | R&S           | 2023-04-16                    | 1Y                      |
| EM031-02-01                               | Coaxial cable(9 kHz-1 GHz)                                     | N/A                  | R&S           | 2023-04-08                    | 1Y                      |
| EM033-02-02                               | Coaxial cable(1 GHz-18 GHz)                                    | N/A                  | R&S           | 2023-04-08                    | 1Y                      |
| EM033-04-02                               | Coaxial cable(18 GHz~40 GHz)                                   | N/A                  | R&S           | 2023-04-15                    | 1Y                      |
| EM031-01                                  | Signal Generator (9 kHz~6 GHz)                                 | SMB100A              | R&S           | 2023-07-17                    | 1Y                      |
| EM040-01                                  | Band Reject/Notch Filter                                       | WRHFV                | Wainwright    | N/A                           | 1Y                      |
| EM040-02                                  | Band Reject/Notch Filter                                       | WRCGV                | Wainwright    | N/A                           | 1Y                      |
| EM040-03                                  | Band Reject/Notch Filter                                       | WRCGV                | Wainwright    | N/A                           | 1Y                      |
| EM022-03                                  | 2.45 GHz Filter  | BRM50702             | Micro-Tronics | 2023-05-06                    | 1Y                      |
| SA016-29                                  | Climatic Test Chamber  | MHU-80L              | JIANQIAO      | 2023-01-20                    | 1Y                      |
| SA012-74                                  | Digital Multimeter   | FLUKE175             | FLUKE         | 2023-10-07                    | 1Y                      |
| EM010-01                                  | Regulated DC Power supply                                      | PAB-3003A            | GUANHUA       | N/A                           | 1Y                      |
| SA040-22                                  | Regulated DC Power supply                                      | IT6721               | ITECH         | 2023-09-04                    | 1Y                      |
| EM084-06                                  | Audio Analyzer   | 8903B                | HP            | 2023-04-11                    | 1Y                      |
| EM046-05                                  | Power meter  | NPR6A                | R&S           | 2023-04-20                    | 1Y                      |
| EM046-06                                  | Power meter  | NPR6A                | R&S           | 2023-04-20                    | 1Y                      |
| EM045-01-01                               | EMC32 software (RE/RS)   | V10.01.00            | R&S           | N/A                           | N/A                     |
| EM045-01-09                               | EMC32 software (328/893)                                       | V9.26.01             | R&S           | N/A                           | N/A                     |
| Conducted emission at the mains terminals |  |                      |               |                               |                         |
| Equipment No.                             | Equipment  | Model                | Manufacturer  | Cal. Due date<br>(YYYY-MM-DD) | Calibration<br>Interval |
| EM080-05                                  | EMI receiver   | ESCI                 | R&S           | 2023-06-08                    | 1Y                      |
| EM006-05                                  | LISN   | ENV216               | R&S           | 2023-06-05                    | 1Y                      |
| EM006-06                                  | LISN   | ENV216               | R&S           | 2023-09-05                    | 1Y                      |
| EM006-06-01                               | Coaxial cable  | /                    | R&S           | 2023-04-08                    | 1Y                      |
| EM004-04                                  | EMC shield Room  | 8m×3m×3m             | Zhongyu       | 2023-01-06                    | 1Y                      |

\*\*\*\*\*End of the test report\*\*\*\*\*