

INSTRUCTION MANUAL AIR PURIFIER



Model No: KF-P31W

Keep these instructions for future reference

Thank you for purchasing the innovative KF-P31W air purifier. We wish you many years of healthy indoor air with this efficient and effective product.

Ensure that all safety precautions are followed when using this air purifier for the proper operation of the device. These instructions describe the safety precautions to be observed during operation. They are designed to prevent injuries or damage to this device.

SAFETY PRECAUTIONS

1. Our air purifier is used 120V, 60Hz.
2. Cleaning the unit, while it is plugged in may result in electric shock, electric spark and serious injury. Unplug the unit before cleaning or maintenance.
3. Air purifier are obviously damaged must not be operated.
4. According to the working environment, the device needs to be cleaned within 2-4 weeks. Before cleaning, unplug the device, open the back cover, remove the filter, wipe the interior of the device with a wet towel.

WARNING

To reduce the risk of fire, electric shock or injury, read and understand this user guide before operation this air purifier.

1. The air purifier is not to be used by persons (including children) with reduced physical, sensory or mental capabilities, or lack of experience and knowledge, unless they have been given supervision or instruction. Children being supervised not to play with the air purifier.
2. This air purifier can be used by children aged from 8 years and above and persons with reduced physical, sensory or mental capabilities or lack of experience and knowledge if they have been given supervision or instruction concerning use of the air purifier in a safe way and understand the hazards involved. Children shall not play with the air purifier. Cleaning and user maintenance shall not be made by children without supervision.
3. If the supply cord is damaged, it must be replaced by the manufacturer, its service agent or similarly qualified persons in order to avoid a hazard.
4. Do not operate unite if cord or plug is damaged. Doing so can result in electric shock. Discard the damaged unite or take if to an authorized service facility for examination and /or repair.

5. Do not run cord under carpeting. Do not cover cord with throw rugs, runners or similar coverings. DO NOT ROUTE CORD UNDER FURNITURE OR AIR PURIFIER. Arrange cord away from traffic area and where it will not be tripped over.
6. Only use the air purifier as described in this manual.
7. Do not handle the unit with wet hands. Thoroughly dry your hands before handling any part of the air purifier.
8. Hair, loose clothing and body parts can get caught in the air purifier resulting in injury. Keep hair, loose clothing and body parts away from openings and moving parts.
9. Do not unplug by pulling on the cord. Doing so may result in electrical spark or fire, unplug the unit by grasping. And pulling the plug.
10. Do not use an extension cord.
11. Do not place the air purifier near sources of heat, such as: stove tops, ovens, radiators or computers.
12. Unplug the air purifier from the power supply before servicing.
13. This equipment should be inspected frequently and the dirt that has collected should be removed regularly to prevent excessive accumulation that may result in flash over or fire.
14. Do not use the air purifier outdoors or on wet surfaces.

15. Do not use the air purifier in an enclosed space where flammable, combustible or explosive gases are present.
16. Do not use in an area where toxic vapors, flammable dust or oxygen tanks are present. Checked the location and make sure these elements are not present.
17. Do not place open flames, including candles, directly in front of the air purifier.
18. It is important to keep all objects away from the air intake grille.
19. Place the air purifier on a flat, solid, stable surface. Never place the unit on soft surfaces such as a bed or sofa.
20. Position the air purifier so that the dirty air is not drawn across your head or body while sitting or sleeping.
21. Place the air purifier so the plug on the power cord easily reaches a standard electrical outlet for a polarized plug.
22. Children should be supervised when product is in used. Do not allow children to play on or near the air purifier. Keep children's hair, loose clothing, and body parts away from/ out of the intake grille, bents, holes, or openings.
23. This product is suitable for use with solid-state speed controls.

FCC Statement

This equipment has been tested and found to comply with the limits for a Class B digital device, pursuant to part 15 of the FCC Rules. These limits are designed to provide reasonable protection against harmful interference in a residential installation. This equipment generates, uses and can radiate radio frequency energy and, if not installed and used in accordance with the instructions, may cause harmful interference to radio communications. However, there is no guarantee that interference will not occur in a particular installation. If this equipment does cause harmful interference to radio or television reception, which can be determined by turning the equipment off and on, the user is encouraged to try to correct the interference by one or more of the following measures:

- Reorient or relocate the receiving antenna.
- Increase the separation between the equipment and receiver.
- Connect the equipment into an outlet on a circuit different from that to which the receiver is connected.
- Consult the dealer or an experienced radio/TV technician for help.

Caution: Any changes or modifications

to this device not explicitly approved by manufacturer could void yo

ur authority to operate this equipment. This device complies with part 15 of the FCC Rules. Operation is subject to the following two conditions: (1) This device may not cause harmful interference, and (2) this device must accept any interference received, including interference that may cause undesired operation.

RF Exposure Information

This equipment complies with FCC radiation exposure limits set forth for an uncontrolled environment. This equipment should be installed and operated with minimum distance 20cm between the radiator and your body.

ISED Statement

English: This device contains licence-exempt transmitter(s)/receiver(s) that comply with Innovation, Science and Economic Development Canada's licence-exempt RSS(s). Operation is subject to the following two conditions:

- (1) This device may not cause interference.
- (2) This device must accept any interference, including interference that may cause undesired operation of the device.

The digital apparatus complies with Canadian CAN ICES-3 (B)/NMB-3(B).

French: Cet appareil contient des émetteurs/récepteurs exempts de licence qui sont conformes aux RSS exemptés de licence d'Innovation, Sciences et

Développement économique Canada.

L'exploitation est soumise aux deux conditions suivantes :

- (1) Cet appareil ne doit pas provoquer d'interférences.
- (2) Cet appareil doit accepter toute interférence, y compris les interférences susceptibles de provoquer un fonctionnement indésirable de l'appareil.

l'appareil numérique du ciem conforme canadien peut - 3 (b) / nmb - 3 (b).

This device meets the exemption from the routine evaluation limits in section 2.5 of RSS 102 and compliance with RSS 102 RF exposure, users can obtain Canadian information on RF exposure and compliance.

cet appareil est conforme à l'exemption des limites d'évaluation courante dans la section 2.5 du cnr - 102 et conformité avec rss 102 de l'exposition aux rf, les utilisateurs peuvent obtenir des données canadiennes sur l'exposition aux champs rf et la conformité.

This equipment complies with Canada radiation exposure limits set forth for an uncontrolled environment.

Cet équipement est conforme aux limites d'exposition aux rayonnements du Canada établies pour un environnement non contrôlé.

This equipment should be installed and operated with minimum distance 20cm between the radiator & your body. Cet équipement doit être installé et utilisé à une distance minimale de 20 cm entre le radiateur et votre corps

PRODUCT DIAGRAM

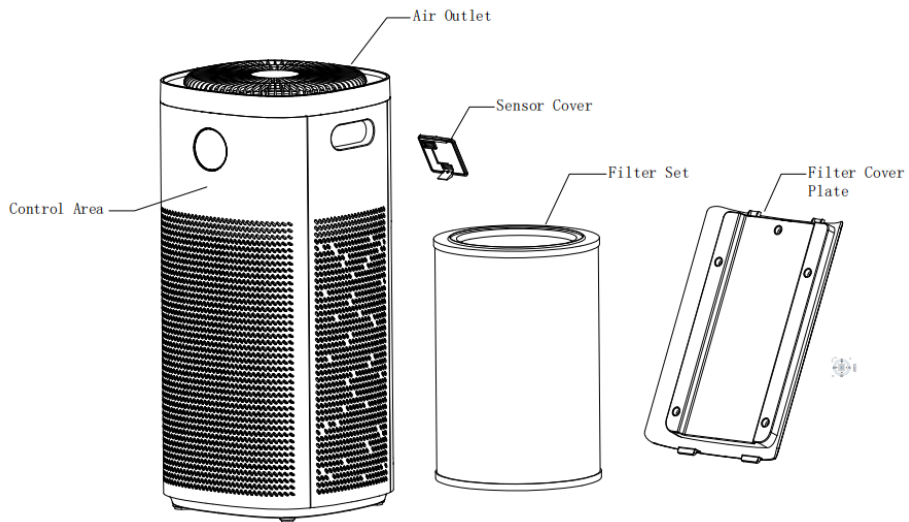

FEATURES AND OPERATION



Power



Speed



Timer



ION/UV





Sleep

instructions for usage

Power: When plug in, display will be on for 1 second and a beep sound will be heard. The "OFF" character will be shown and  "WIFI" icon (for WIFI version only) will flash (it will always be on after connecting to the App in mobile phone), then the air purifier keep in standby state.

Touch "Power" button, air purifier starts up and the air quality indicator on the screen alternates between green, blue, yellow and red. Display shows "A" means the air purifier is working in Auto Mode with medium speed for 5 seconds. Then the "A" changes to flashing "000". 10 seconds later, it begins to show air quality in real-time data. Air quality indicator shows air quality in the corresponding color and air purifier will adjust the speed according to the air quality automatically.



Auto Mode Chart			
Color	Air Quality	PM2.5 Data	Fan Speed
Red	Bad	> 115	High
Yellow	Moderate	115~76	Medium
Blue	Good	75~36	Low
Green	Very Good	< 36	Lower

Speed: Touch "Speed" button air purifier will exit the Auto Mode. Cycles through fan speeds:  low speed,  medium speed and  high speed.

The fan speed cannot be changed during Auto or Sleep modes.



Timer: Touch "Timer" button, "--H" icon flashes in display. Touch the button continually to set the timer from 1~12 hours, after choosing desired timer, display stop flashing and switch to show PM2.5 data, it means setting is done. It calculates by counting down every hour. When the time is up, the air purifier shuts down.

Touch the button till icon "--H" or long press the button for 2 seconds to cancel timer setting.

ION/UV: Touch  "ION/UV" button to turn on the Anion function with according icon  show. Touch the button again to turn on UV function with according icon

 show. Touch the third time to turn off Anion function. Touch fourth time to turn off the UV function.



Sleep: Touch "Sleep" button, the air purifier will enter Sleep Mode. Sleep Mode uses the lowest possible fan speed (even lower in Auto Mode) to create a quite environment.

Display only shows the icon  with 1\3 brightness. The air purifier works at the lowest speed. Touch any button to illumine the display in 1\3 brightness, then you can operate other functions. If 15 seconds without any operation, display show the icon  with 1\3 brightness only again. Touch again to

turn back to Auto Mode.



Display turn off function: Long press "Sleep" button for 2 seconds to turn off the display. Touch any button to illuminate the display in 1/3 brightness, and then press it to operate other functions. 15 seconds without any operation, display turns off again. Long press this button to exit display turn off function.

FILTER CHANGE

When air purifier working hours reach to 3000H, the filter change indicator icon  in the display flashing in red to remind user change filter till filter changed. After filter is changed, in standby mode, touch "Speed" button 2 times continually, then hold this button for 2 seconds, filter change indicator icon  will flash quickly. 5 seconds later the whole display flashes for a second and then turn off to enter in standby mode. It means filter exchange is finished. At the moment, touch "Power" button to switch on the air purifier.

Note: 3000 hours is calculated based on low speed. It will remind filter change less than 3000 hours if the air purifier works in other speeds.

WIFI OPERATION INSTRUCTION

1. Download "Tuya Smart" from App store. After installment, register by E-mail or mobile number, and then follow below steps.
2. Long press "Power" button for about 3 seconds (or long press for about 6 seconds to enter AP mode), display shows WIFI icon  and keep twinkling. It means the air purifier has entered the network state successfully. (If you long press this button for about 10 seconds, the air purifier will exit the connection with the mobile APP).
3. Enter App, add corresponding device and then follow the operation as App indicated.
4. When the App is connected to the air purifier successfully, the WIFI icon  on the screen will be on, and then the App can control the air purifier.

REMOTE CONTROLLER CODE MATCH

In standby mode, touch "ION/UV" button 2 times continually, then hold the button for about 2 seconds. The screen will shows "A1". In that case, hold "SPEED" button on the remote controller for about 2 seconds to match code. When the screen shows "A2", release the button, then display turn to standby mode, that means code match successfully. Remote controller is workable. If code match failed,it will still show "A1", repeat above steps to match again.

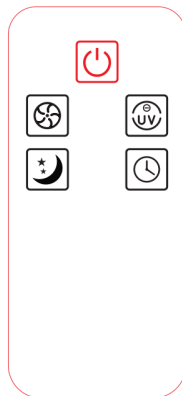

REMOTE CONTROL CODE ELIMINATION

In standby mode, touch "ION/UV" button 2 times continually, then hold the button for about 2 seconds. The screen will shows "A1". In that case, hold this button till A0 show in the display. That means code elimination successfully. Remote controller is not workable.

MAINTENANCE and HOW TO CLEAN THE DUST

1. After using period of time, dust on the sensor will affect its sensitivity. We suggest clean it every two months. But time can be shortened or extended according to indoor environment.
2. Unplug then open the dust sensor cover, and dip the cotton swab in clean water. Clean the lens with cotton swab. Then wipe the lens with dry cotton swab to make it dry.

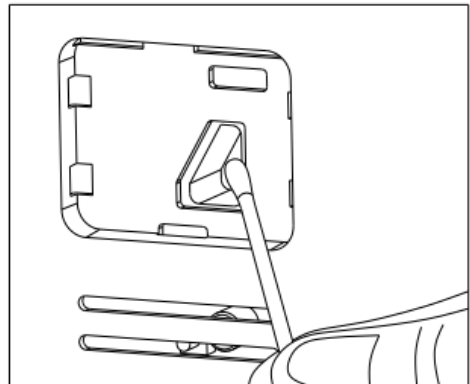
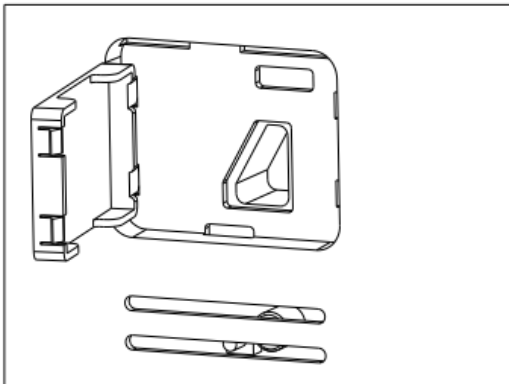

TOUBLESHOOTING

The air purifier has protection function. When the filter cover is removed or not installed well, the air purifier will automatic cut off.

If your air purifier is not working correctly, please check the following causes:

Trouble	Possible reasons	Shooting Way
No power	Fault in power source	Switch on when the power source get regular
Not working	Plug not connected	Insert the plug again
	Fault in electric circuit	Try again in other place
Unusual noise	There is foreign body in the air purifier	Take to service center.
	Dirty filter	Replace the filter
Remote controller not working	Battery run out of power	Change battery

TECHNICAL SPECIFICATIONS

1. Input voltage: AC 120V
2. Frequency: 60Hz
3. Consumption power: 50W
4. Applicable area: 60m²
5. Noise level: ≤55dB(A)

WARRANTY AND SERVICE

WE GUARANTEE THE UNIT TO BE FREE FROM DEFECTS IN MATERIAL OR WORKMANSHIP FOR A PERIOD OF ONE (1) YEAR FROM THE DATE OF PURCHASE.

Should this unit be operated under conditions other than those recommended or at voltages other than the voltage indicated on the unit, or any attempts made to service or modify the unit, this will render WARRANTY VOID. The product you buy may sometimes differ slightly from illustration.



DISPOSAL: Do not dispose this product as unsorted municipal waste. Collection of such waste separately for special treatment is necessary.

<https://www.samyoo.net>